



US00D354830S

# United States Patent [19]

[11] Patent Number: **Des. 354,830**

Setteducati et al.

[45] Date of Patent: **\*\* Jan. 24, 1995**

## [54] SAVINGS BANK

## DESCRIPTION

[75] Inventors: **Mark Setteducati, New York, N.Y.;**  
**Tooru Suzuki, Tokyo, Japan**

FIG. 1 is a top plan view of a savings bank showing our new design;

[73] Assignee: **Tenyo Co. Ltd., Tokyo, Japan**

FIG. 2 is a front elevational view of the savings bank showing our new design;

[\*\*] Term: **14 Years**

FIG. 3 is an elevational view of one side side of the savings bank showing our new design, (other side corresponds);

[21] Appl. No.: **10,765**

FIG. 4 is an underplan view of the savings bank showing our new design;

[22] Filed: **Jul. 19, 1993**

[52] U.S. Cl. .... **D99/34**

FIG. 5 is a rear elevational view of the savings bank showing our new design;

[58] Field of Search ..... **D99/28, 35, 36, 34;**  
**446/4, 11, 12, 13, 8; 232/4 R, 4 D; 206/3, 83**

FIG. 6 is a perspective view from the front, above and one side of the savings bank with a coin receiving slide in a fully raised, coin receiving position, showing our new design, (other side corresponds);

## [56] References Cited

### U.S. PATENT DOCUMENTS

D. 262,749	1/1982	Taivalvuo	.....	D99/34
D. 288,499	2/1987	Wan	.....	D99/36
D. 296,029	5/1988	Knox	.....	D99/35
5,074,819	12/1991	Stadnyk	.....	446/9

FIG. 7 is a front elevational view of the savings bank with the coin receiving slide in a partly lowered, coin depositing position showing our new design;

*Primary Examiner*—Alan P. Douglas  
*Assistant Examiner*—Jeffrey H. Musgrove  
*Attorney, Agent, or Firm*—Robert W. J. Usher

FIG. 8 is a top plan view of a savings bank with the coin receiving slide fully raised and with a coin receiving tray thereof in a coin receiving position, showing our new design; and,

## [57] CLAIM

The ornamental design for a savings bank, as shown and described.

FIG. 9 is a rear elevational view of the savings bank with a lower portion of the base broken away and the coin receiving slide in a fully raised position and with a coin receiving tray thereof in a coin receiving position, showing our new design.

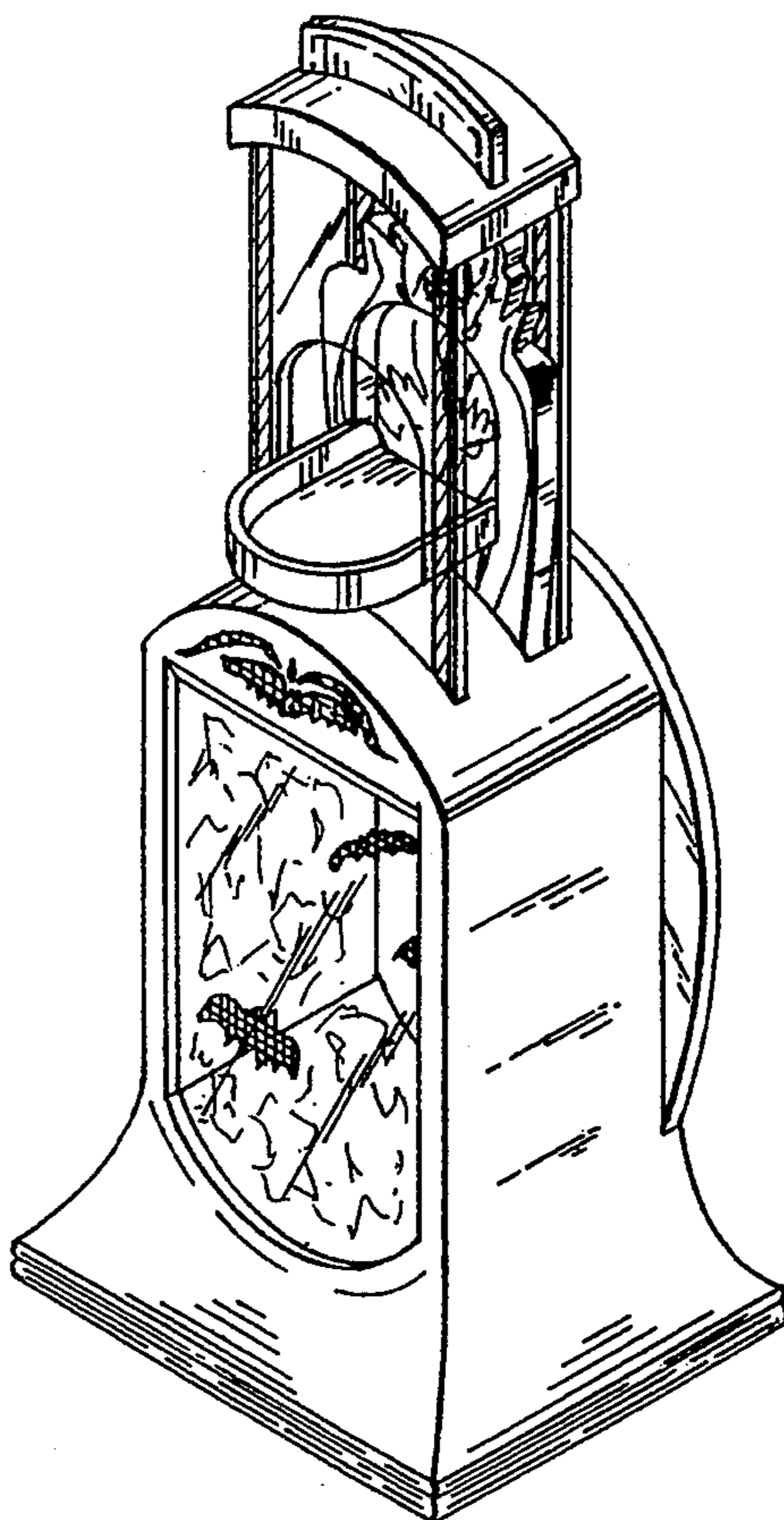

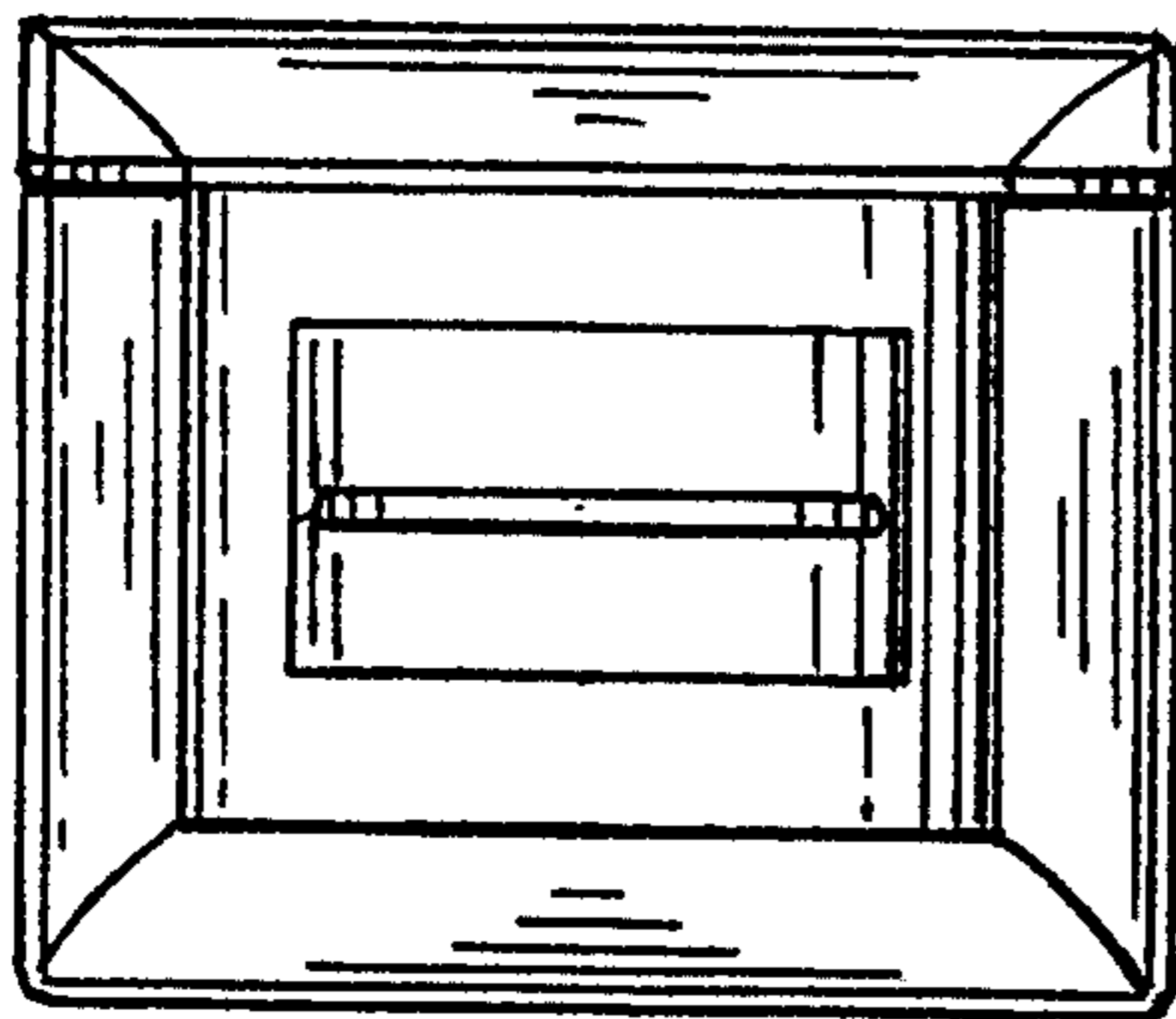

Fig. 1

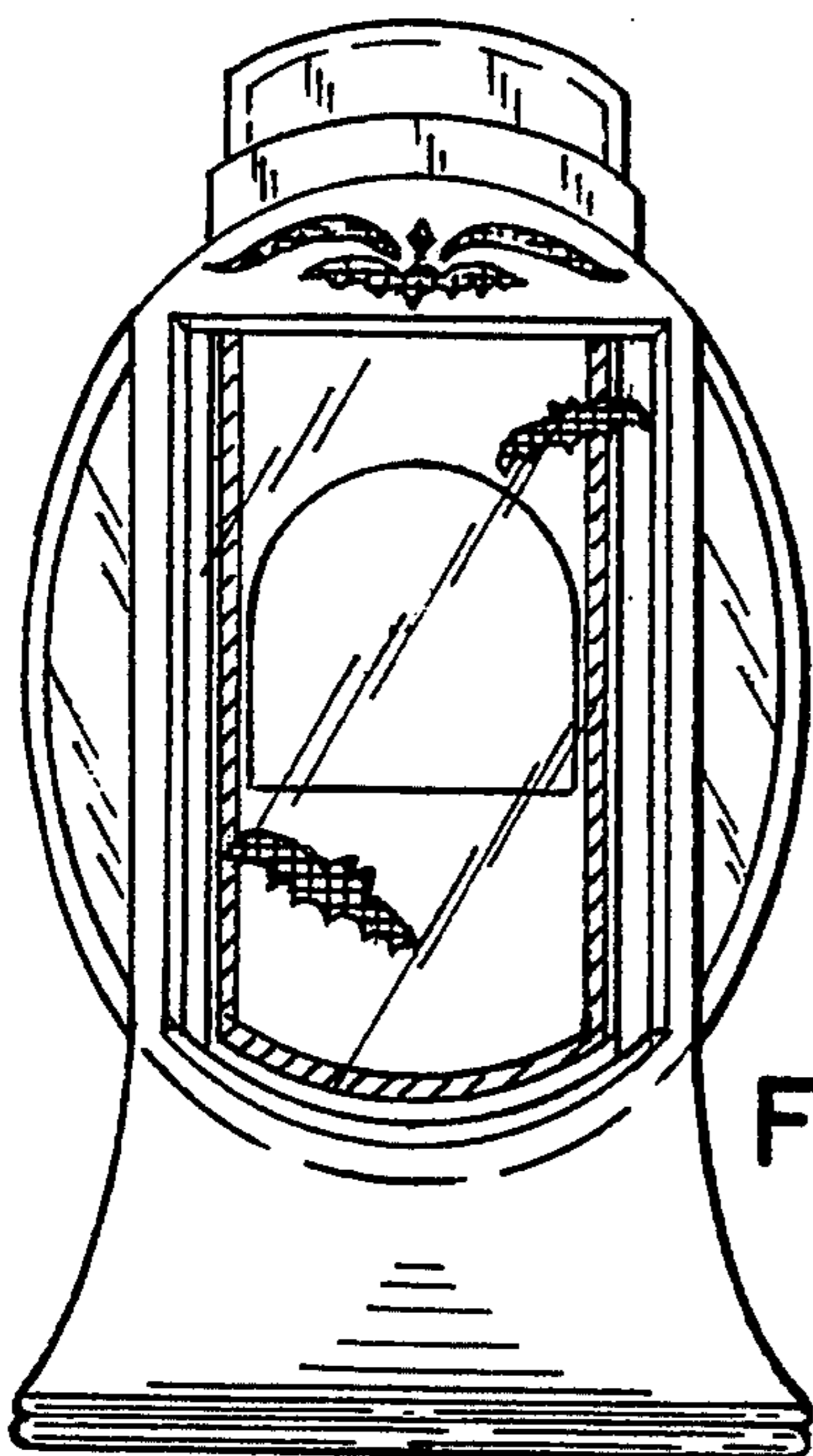

Fig. 2

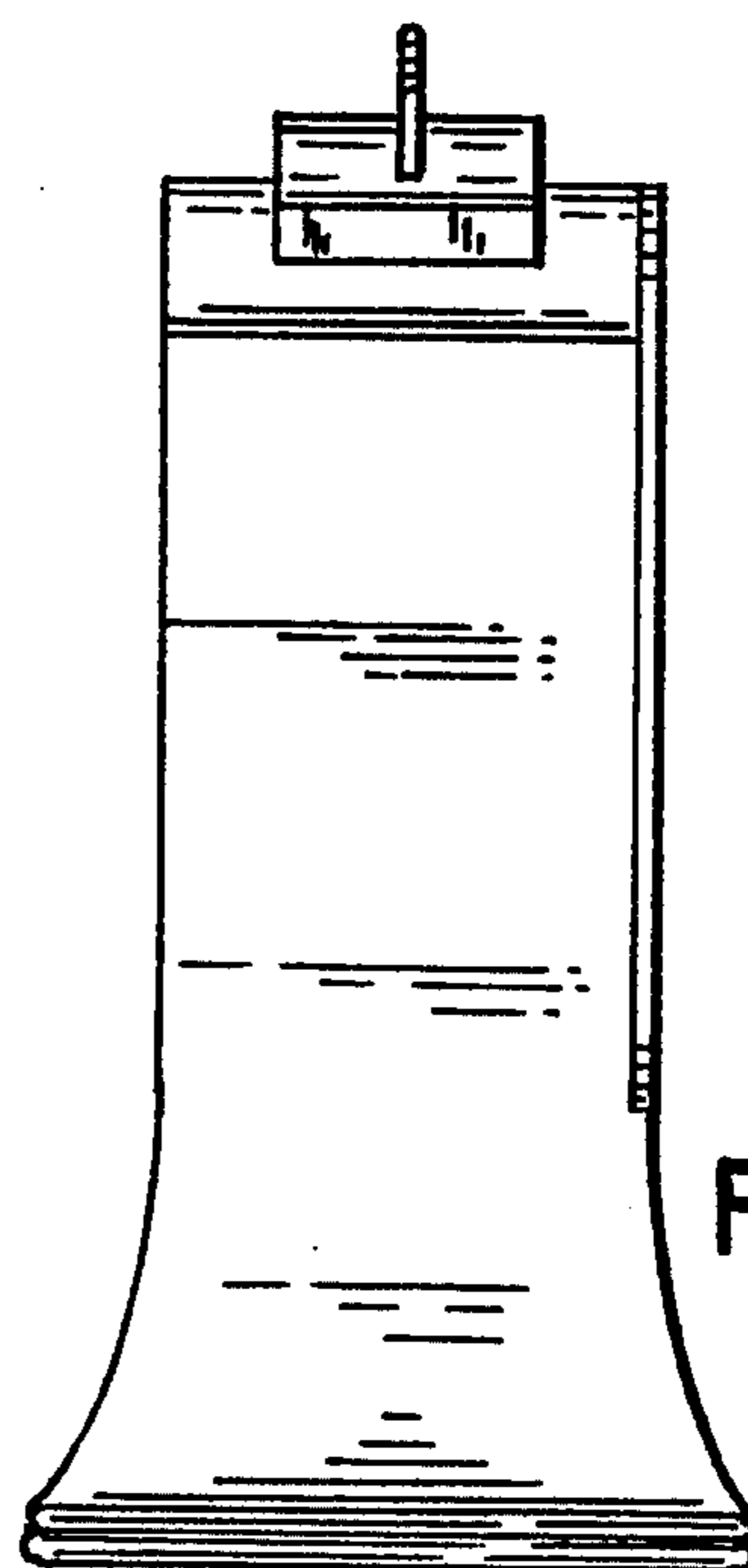

Fig. 3

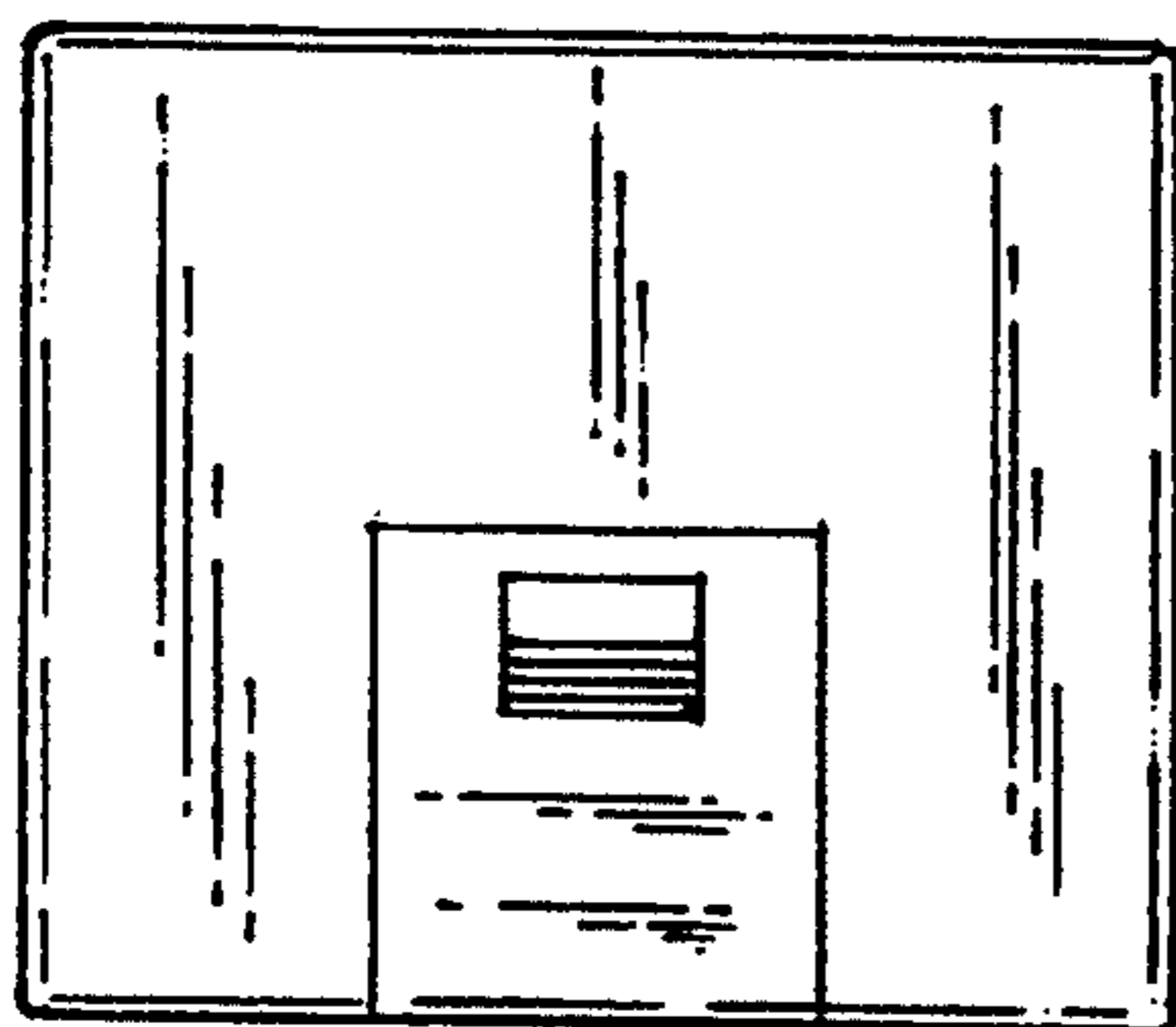

Fig. 4

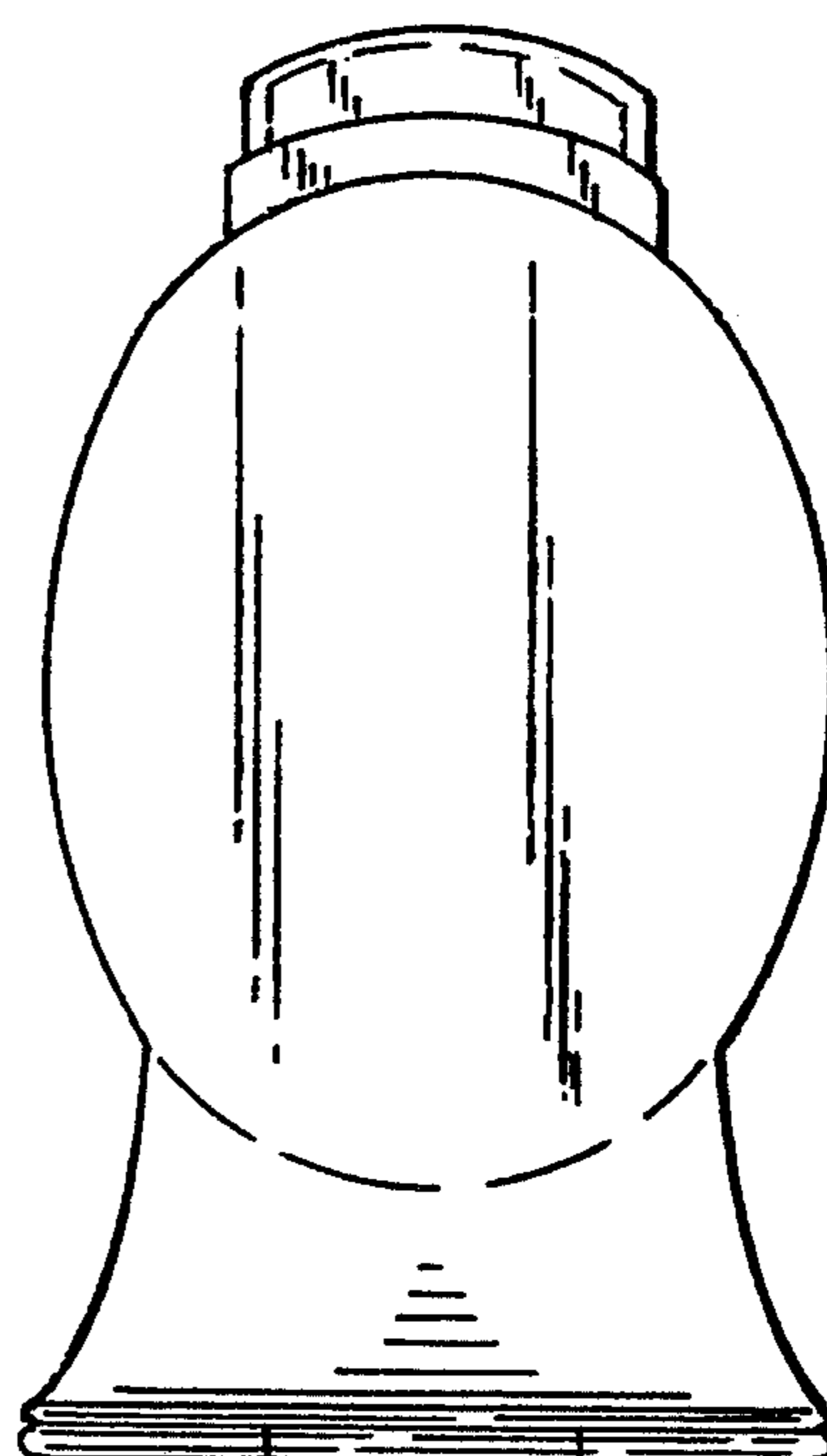

Fig. 5

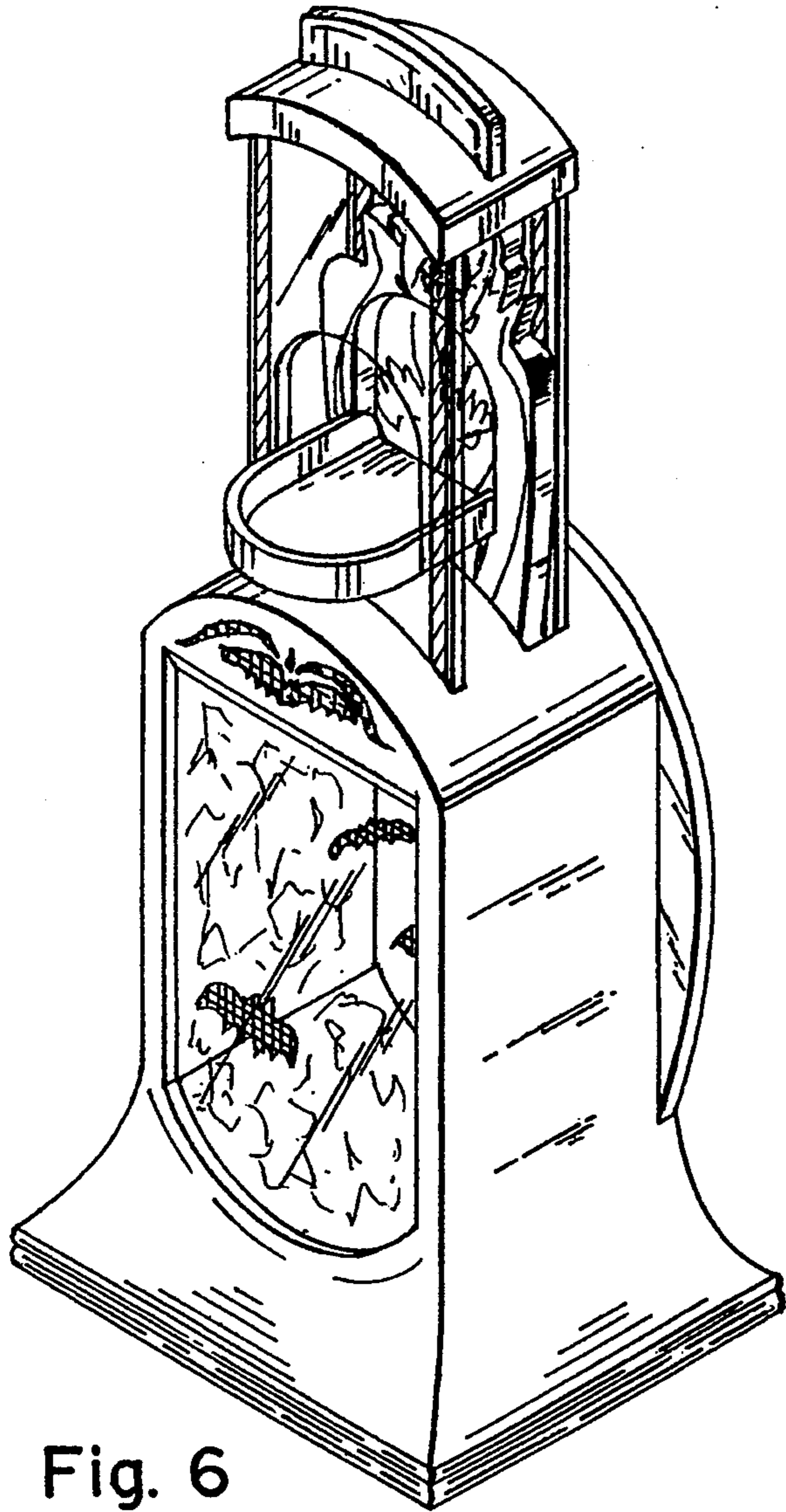

Fig. 6

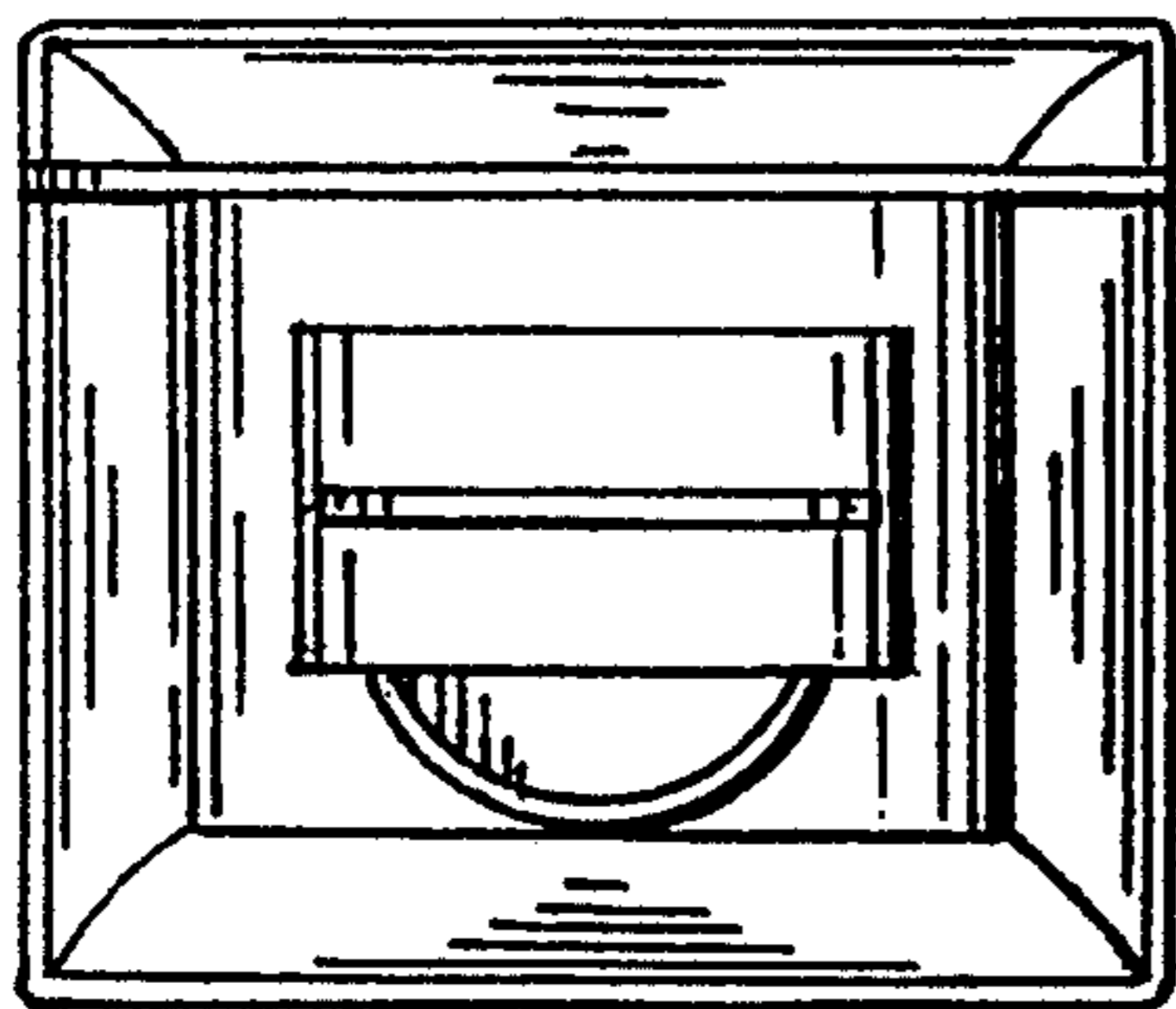

Fig. 8

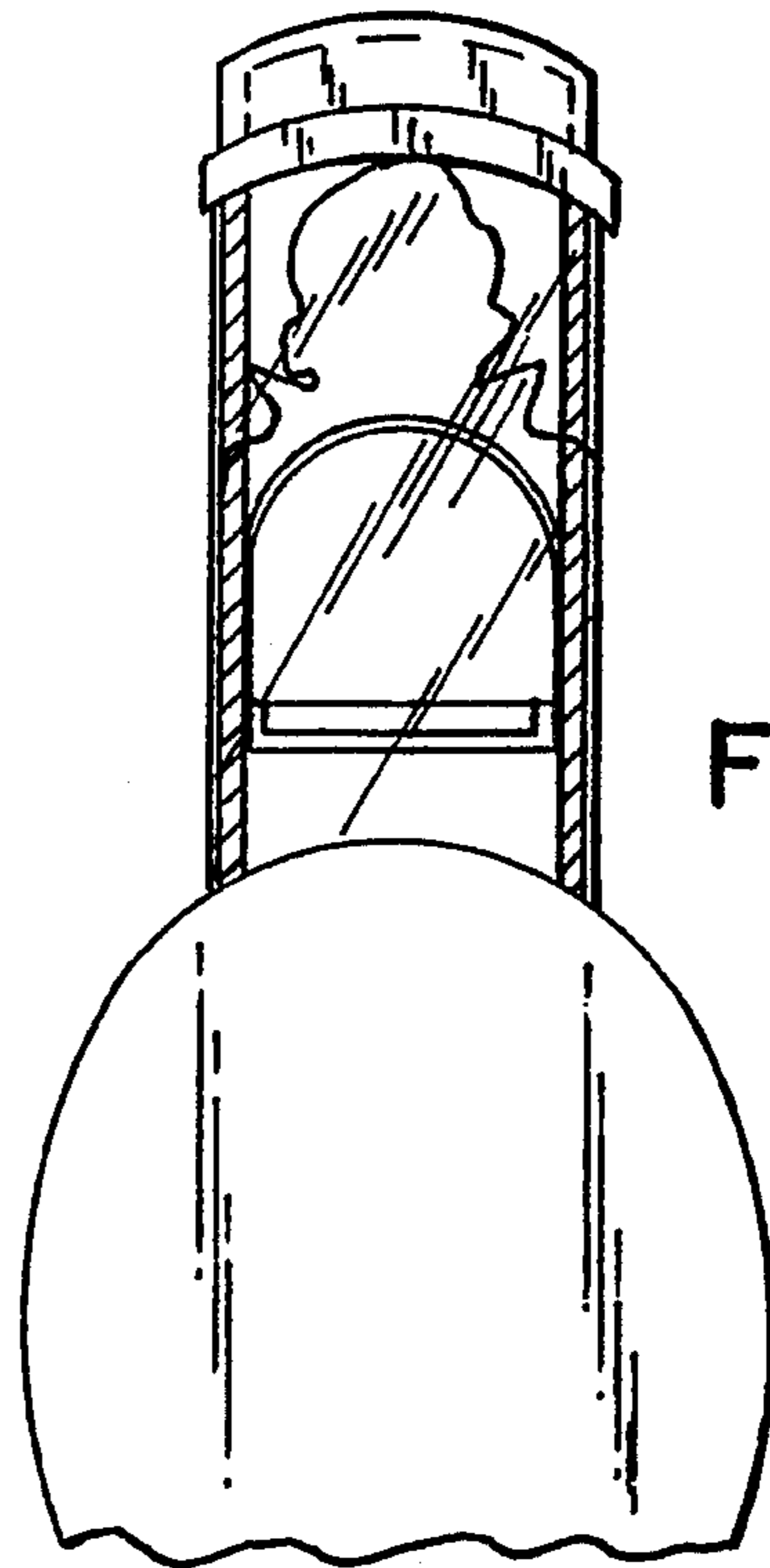

Fig. 9

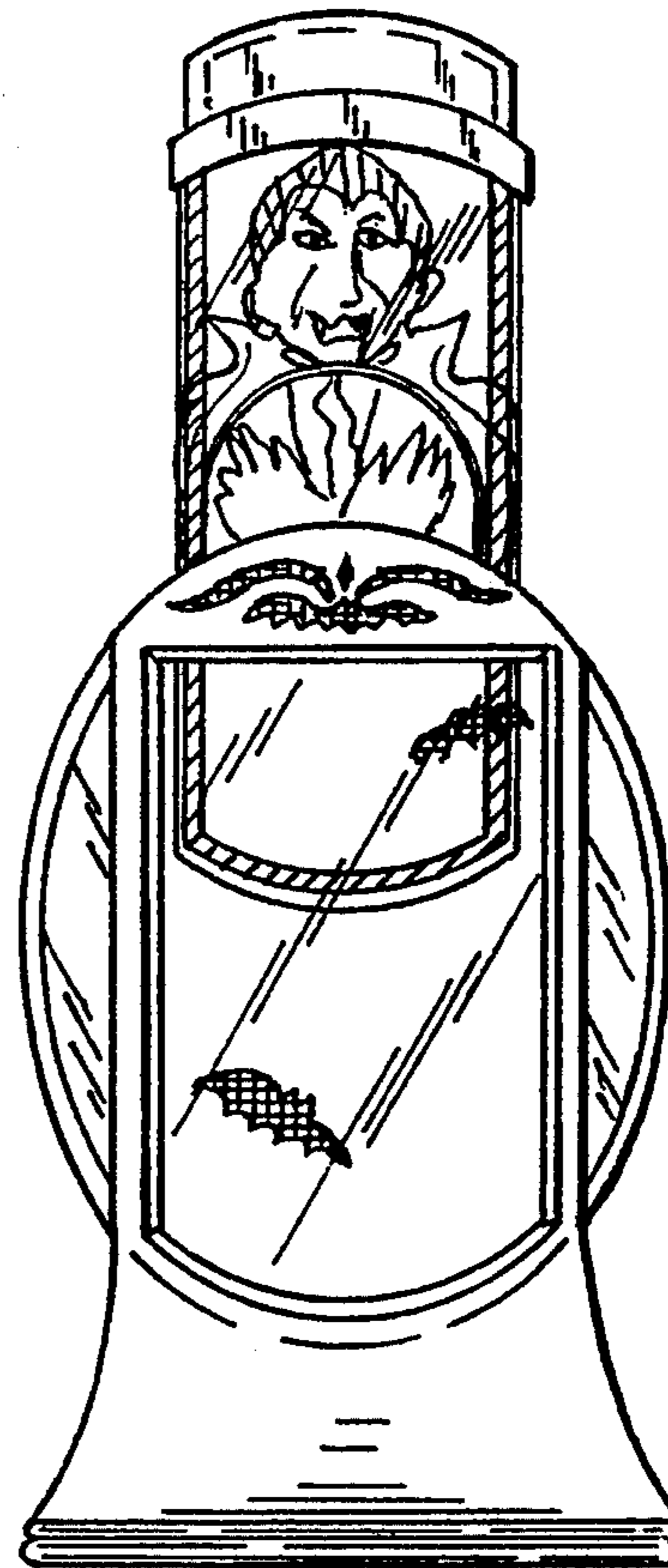

Fig. 7