



US00D354823S

United States Patent [19]

Tsai

[11] Patent Number: **Des. 354,823**

[45] Date of Patent: **** Jan. 24, 1995**

[54] **AUXILIARY AUTOMOBILE LAMP**

D. 270,190 8/1983 Ichikawa D26/28

[76] Inventor: **Wen-Tsung Tsai**, No. 58-3, Lane 410,
Wen Huah Rd., Sec. 2, Baan Chyau,
Taipei, Taiwan, Prov. of China

Primary Examiner—James M. Gandy
Assistant Examiner—Marcus Jackson
Attorney, Agent, or Firm—Beveridge, DeGrandi,
Weilacher & Young

[**] Term: **14 Years**

[57] **CLAIM**

[21] Appl. No.: **17,933**

The ornamental design for a auxiliary automobile lamp,
as shown and described.

[22] Filed: **Jan. 26, 1994**

[52] U.S. Cl. **D26/28**

DESCRIPTION

[58] Field of Search **D26/28-35;**
362/61, 62, 64, 80, 81, 82, 83

FIG. 1 is a body view of a auxiliary automobile lamp
according to present design;
FIG. 2 is a front elevation view of a auxiliary automo-
bile lamp showing my new design;
FIG. 3 is a rear elevation view thereof;
FIG. 4 is the left side elevation view thereof; the right
side elevation view is the same as the left one;
FIG. 5 is a top plan view thereof; and,
FIG. 6 is a bottom plan view thereof.

[56] **References Cited**

U.S. PATENT DOCUMENTS

- D. 237,648 11/1975 Cibie D26/28
- D. 259,814 7/1981 Yabata D26/28
- D. 266,599 10/1982 Suzuki D26/28
- D. 266,956 11/1982 Krity et al. D26/28

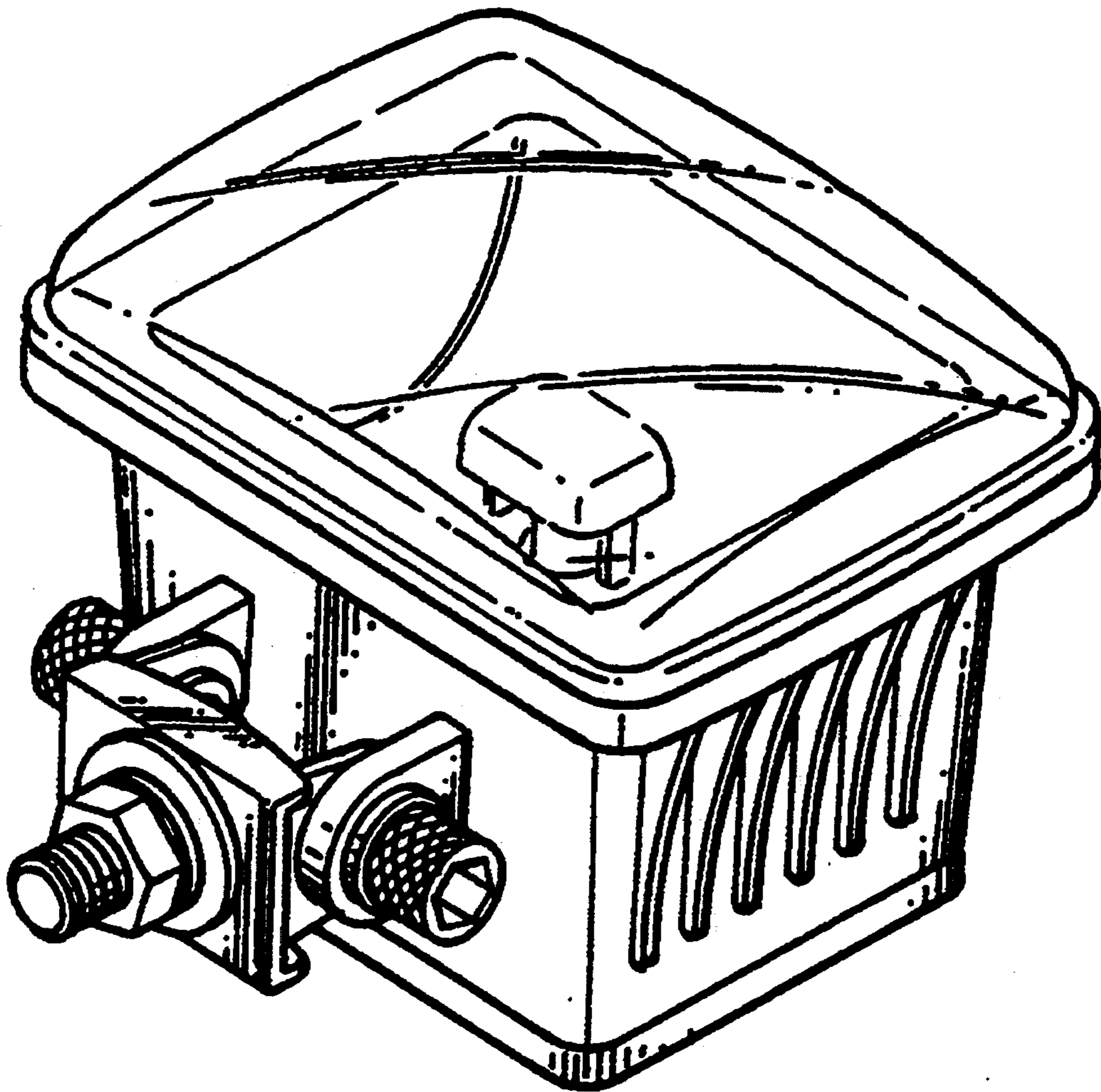

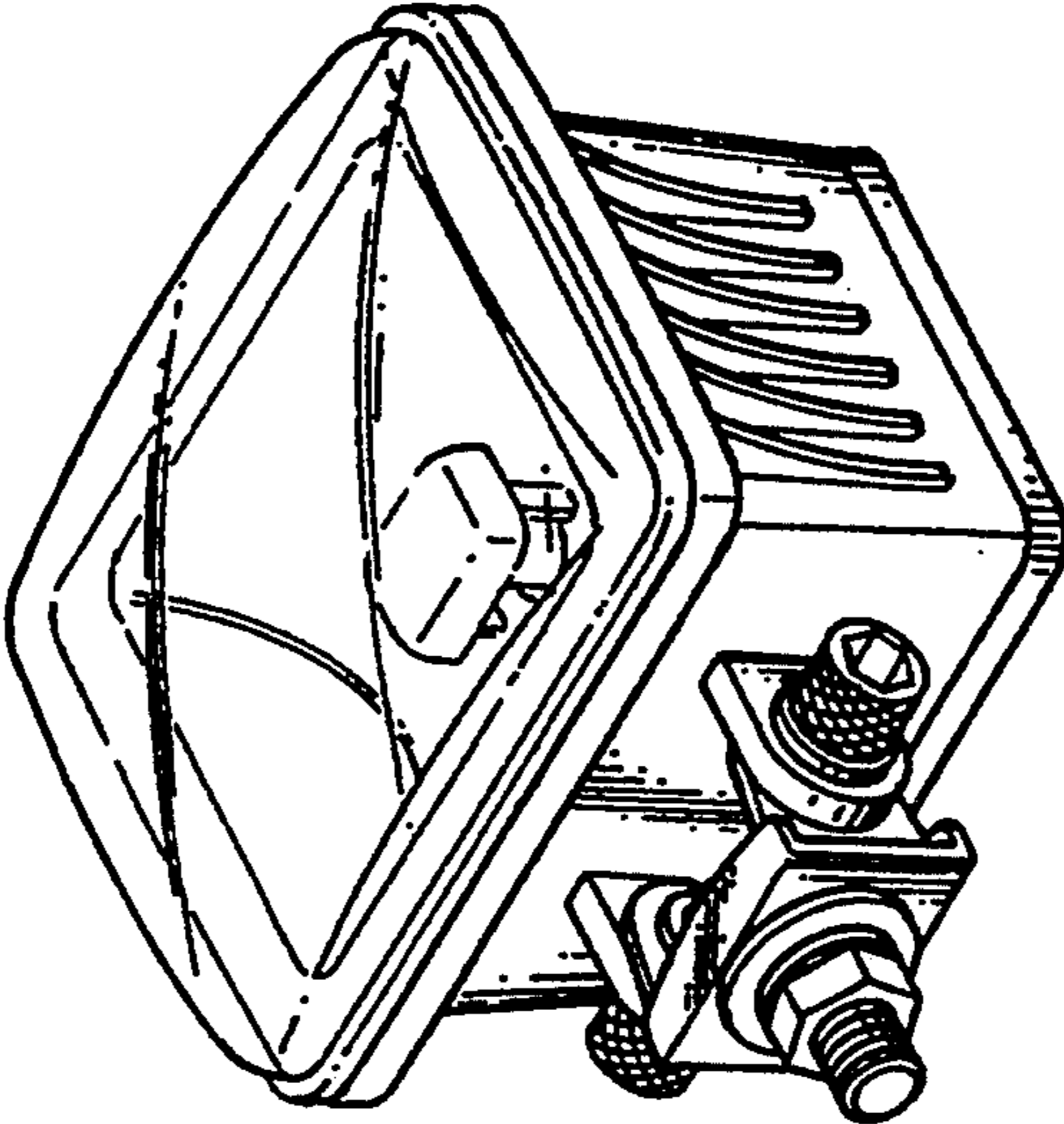

FIG.1

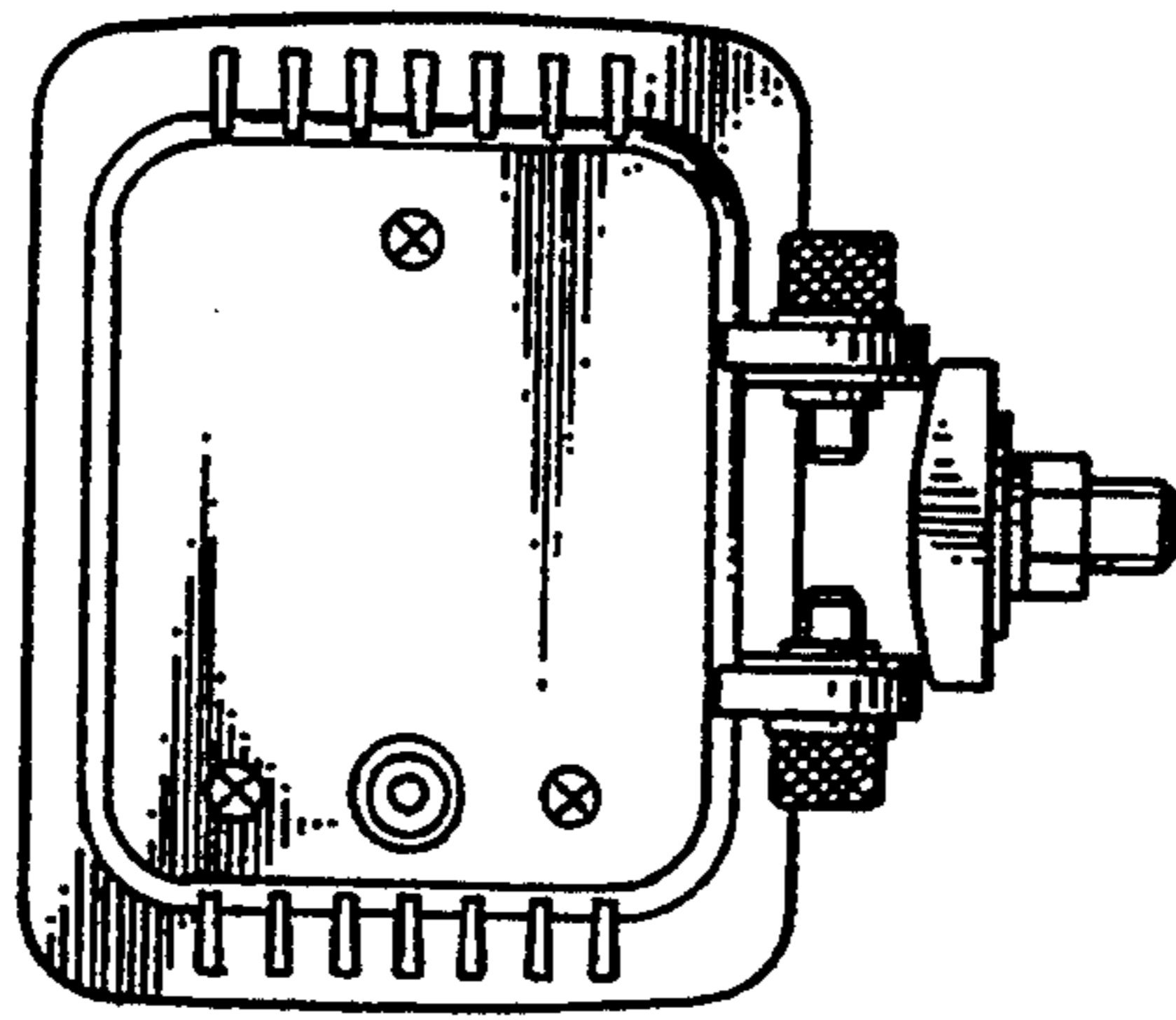

FIG.3

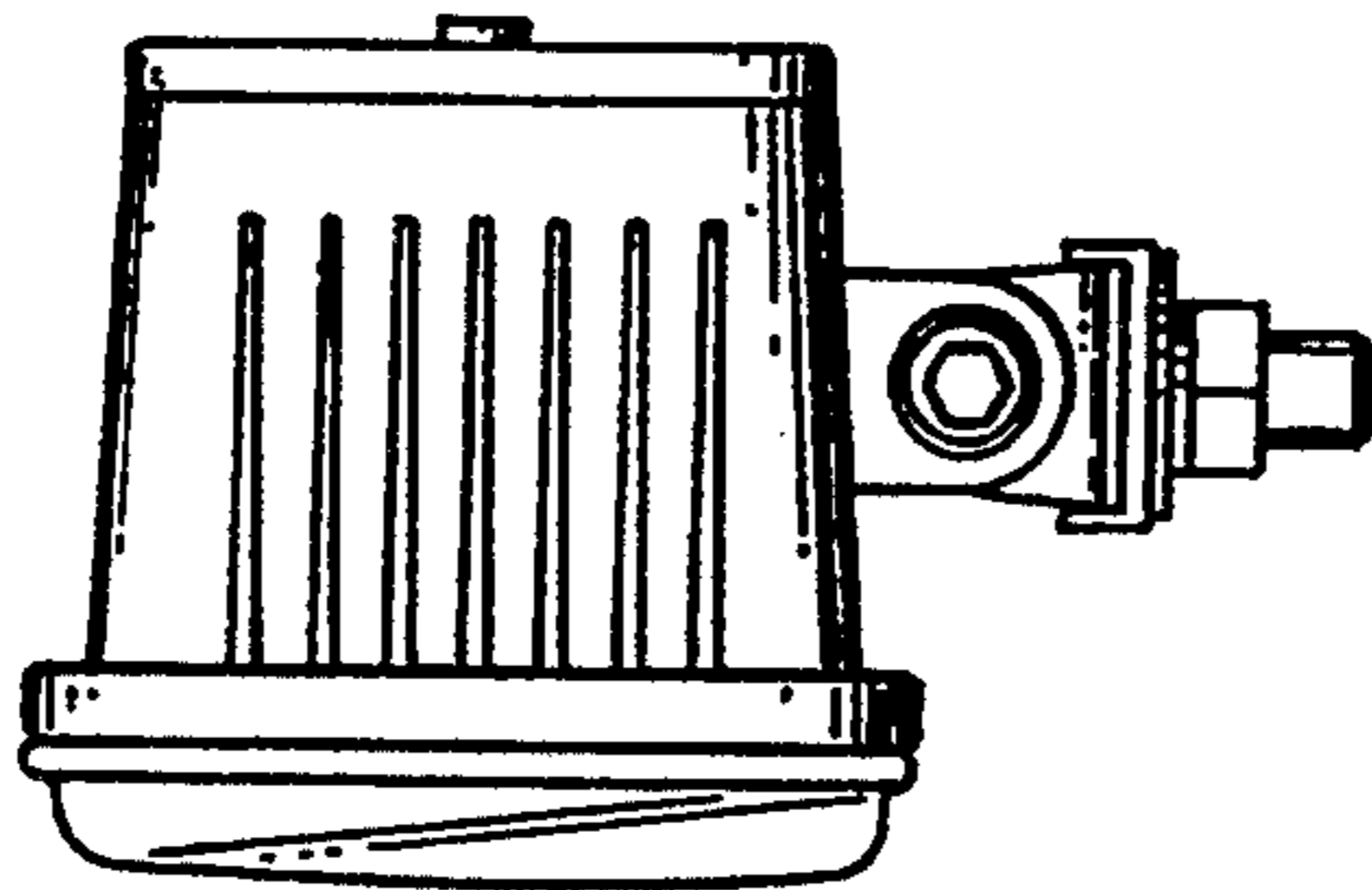

FIG.4

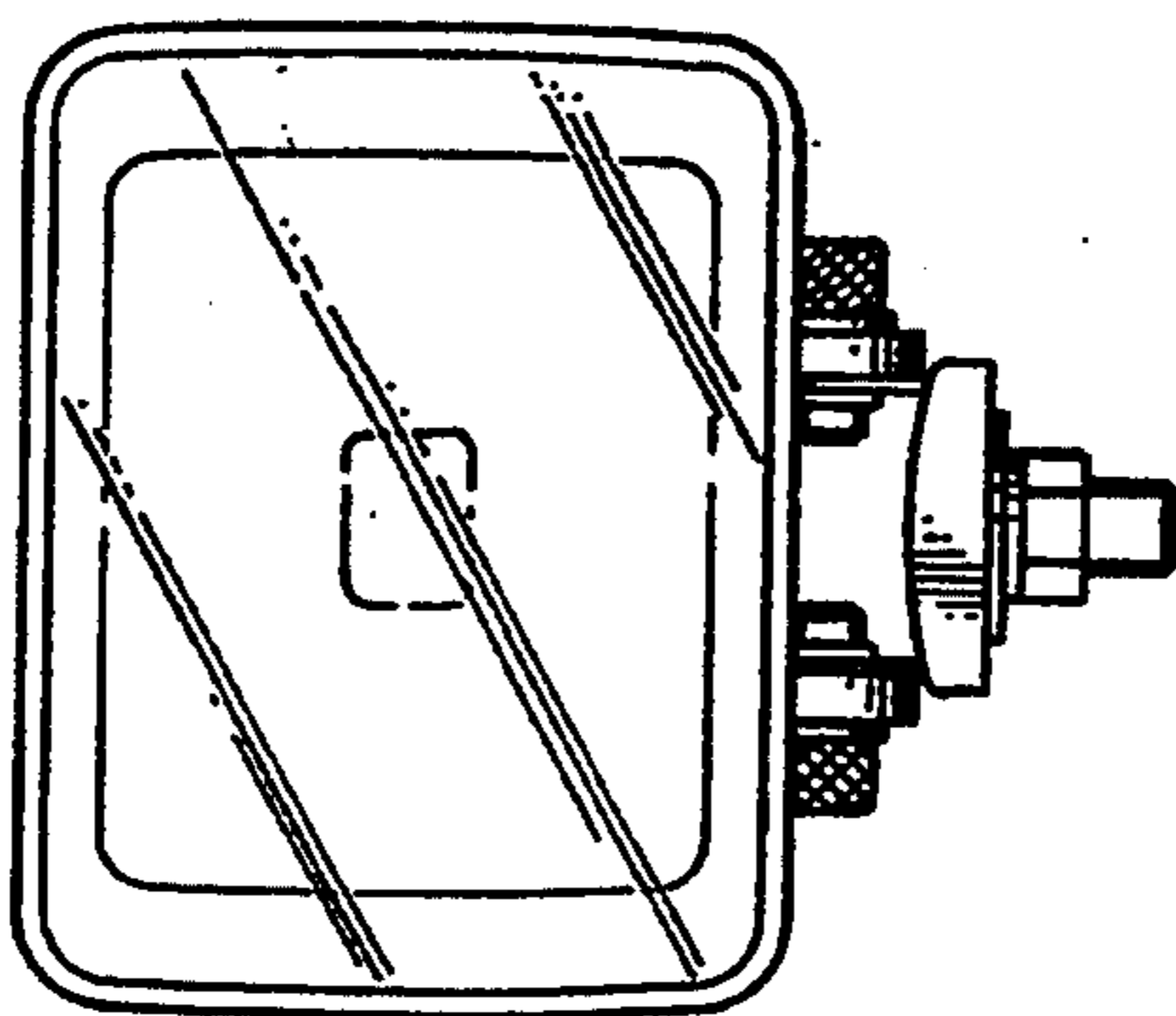

FIG.2

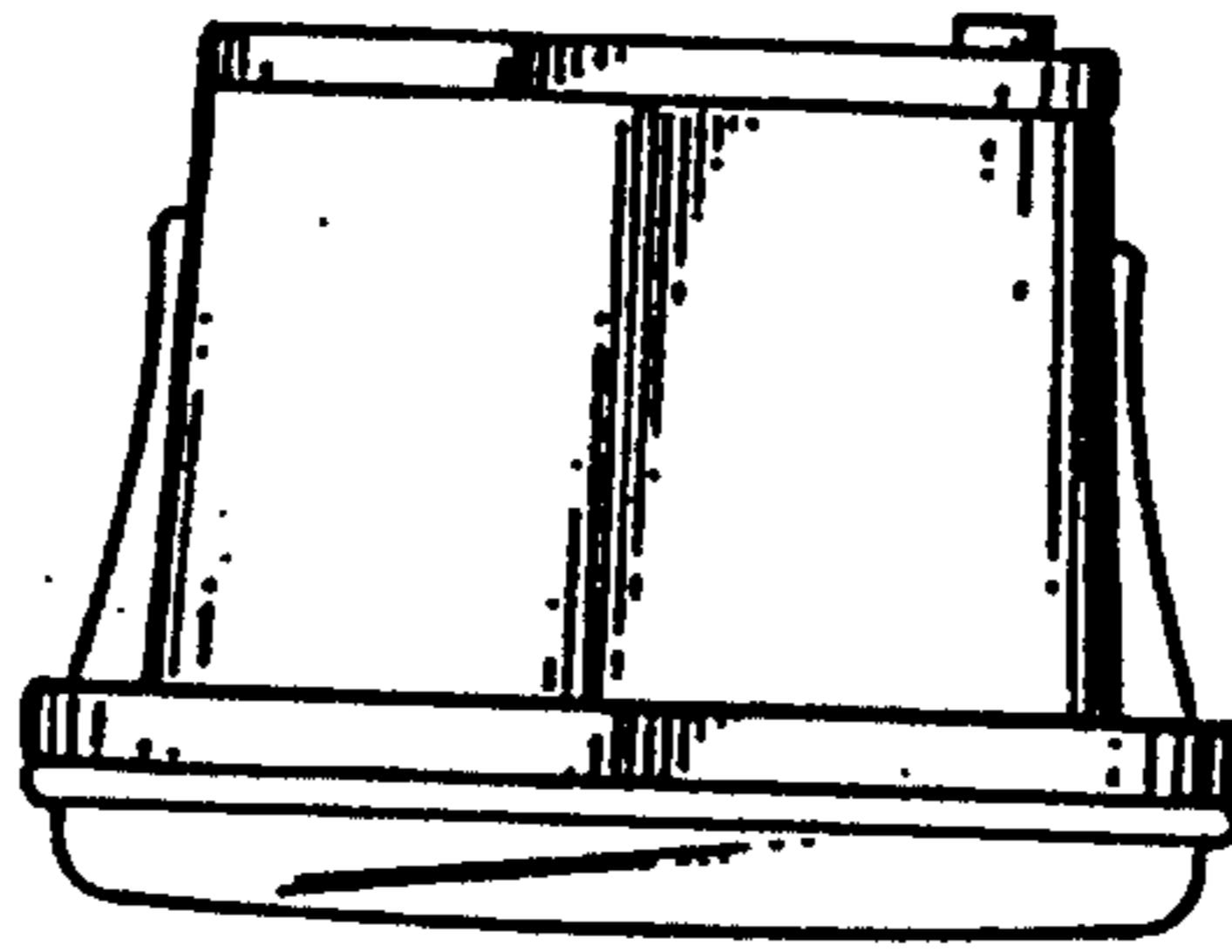

FIG. 5

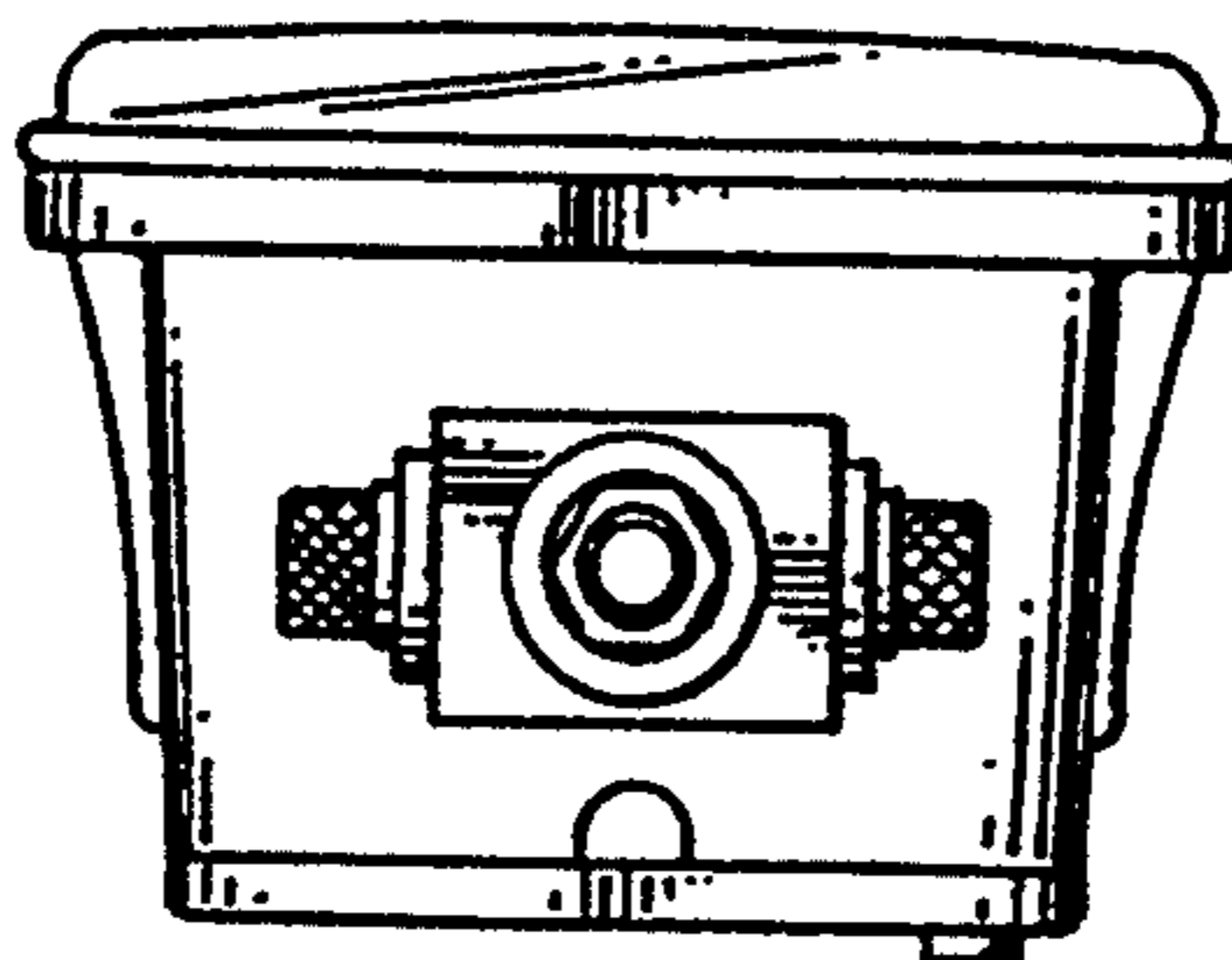

FIG. 6