



US00D354810S

United States Patent [19]

[11] Patent Number: **Des. 354,810**

Nazre

[45] Date of Patent: **** Jan. 24, 1995**

[54] **SURGICAL PARALLEL DRILL GUIDE**

[75] Inventor: **Aniruddha A. Nazre, Warsaw, Ind.**

[73] Assignee: **Zimmer, Inc., Warsaw, Ind.**

[**] Term: **14 Years**

[21] Appl. No.: **11,914**

[22] Filed: **Aug. 17, 1993**

[52] U.S. Cl. **D24/140; D10/65**

[58] Field of Search **D24/140; D10/65; D15/140; 606/96, 53, 98, 87, 88, 89, 102**

5,139,500	8/1992	Schwartz	606/96
5,141,513	8/1992	Fortune et al.	606/96
5,147,367	9/1992	Ellis	606/96
5,154,720	10/1992	Trott et al.	606/96
5,207,682	5/1993	Cripe	606/96
5,207,753	5/1993	Badrinath	606/96
5,234,434	8/1993	Goble et al.	606/96
5,312,409	5/1994	McLaughlin et al.	606/96

[56] **References Cited**

U.S. PATENT DOCUMENTS

D. 269,041	5/1983	Dohogne	D24/26
D. 289,436	4/1987	Odensten et al.	D24/140
D. 291,246	8/1987	Lower	D24/26
2,200,120	5/1940	Nauth	128/83
2,500,370	3/1950	McKibbin	128/92
2,725,053	11/1955	Bambara et al.	128/83
3,171,408	3/1965	Childs et al.	128/83
3,835,849	9/1974	McGuire	128/92 EB
4,360,012	11/1982	McHarrie et al.	128/92 EB
4,383,527	5/1983	Asnis et al.	128/92 EB
4,450,834	5/1984	Fischer	128/92 EB
4,450,835	5/1984	Asnis et al.	128/92 EB
4,502,475	3/1985	Weigle et al.	128/92 EB
4,522,201	6/1985	Tongue	128/92 EB
4,570,624	2/1986	Wu	128/92 EB
4,719,907	1/1988	Banko et al.	128/92 VD
4,788,970	12/1988	Kara et al.	128/92 ND
4,803,976	2/1989	Frigg et al.	128/92 VD
4,917,111	4/1990	Pennig et al.	606/97
4,985,032	1/1991	Goble	606/96
5,098,383	3/1992	Hemmy et al.	604/116
5,108,396	4/1992	Lackey et al.	606/87 X

OTHER PUBLICATIONS

Synthes literature—Instruments for Percutaneous Insertion of AO/ASIF Large Cannulated Screws—1991. Zimmer, Inc.—Catalog pp. C49, C50, C51, C52—Various Drill Guides—1987.

Primary Examiner—A. Hugo Word

Assistant Examiner—I. Simmons

Attorney, Agent, or Firm—Margaret L. Geringer

[57] **CLAIM**

The ornamental design for a surgical parallel drill guide, as shown and described.

DESCRIPTION

FIG. 1 is a perspective view of a surgical parallel drill guide;
FIG. 2 is a side elevational view thereof;
FIG. 3 is a top plan view thereof;
FIG. 4 is an end elevational view thereof;
FIG. 5 is a side elevational view thereof of the side opposite the side shown in FIG. 2;
FIG. 6 is an end elevational view thereof of the end opposite the end shown in FIG. 4; and,
FIG. 7 is a bottom plan view thereof.
The broken line showing of the sleeve member in FIG. 1 is for illustrative purposes only and forms no part of the claimed design.

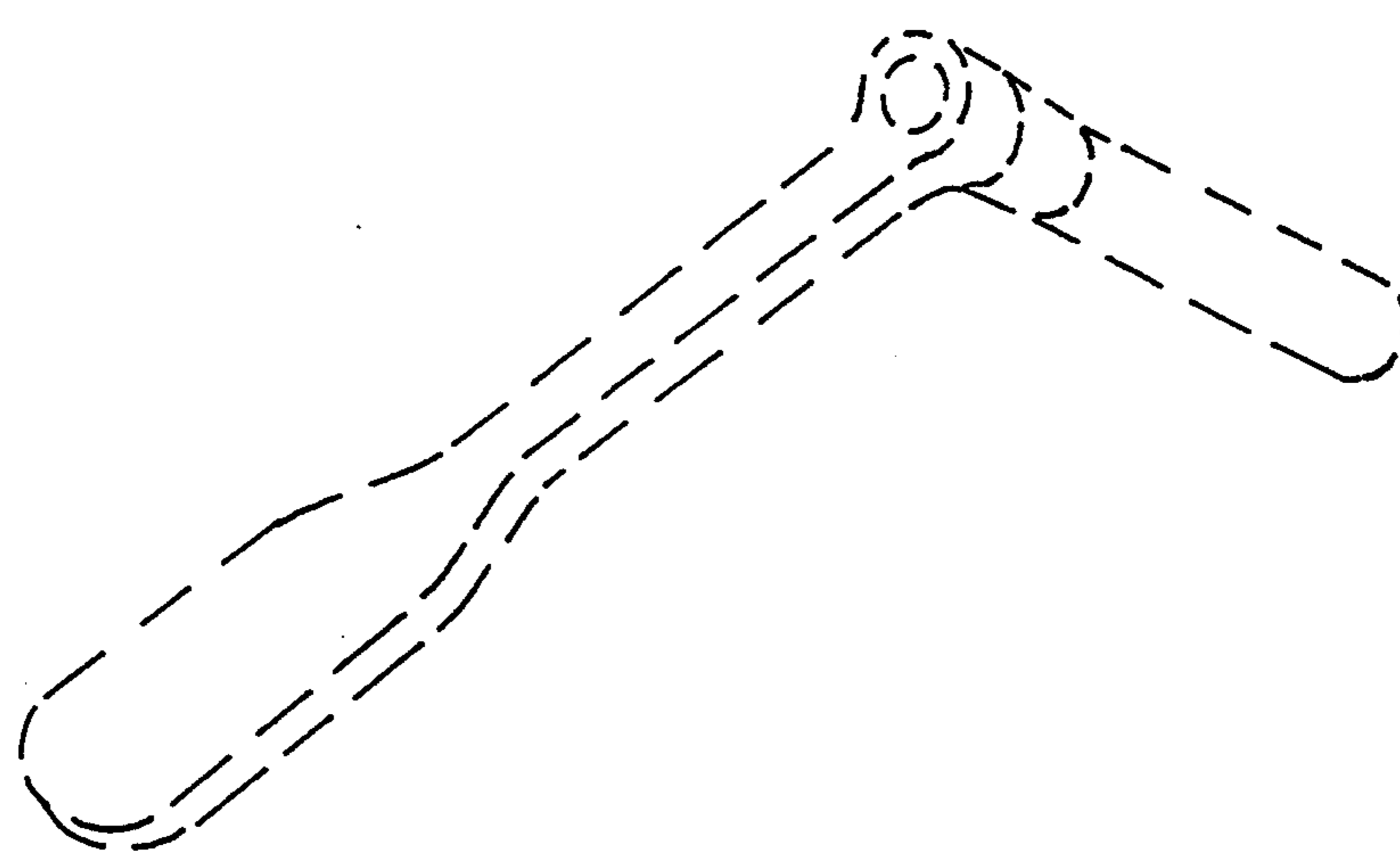

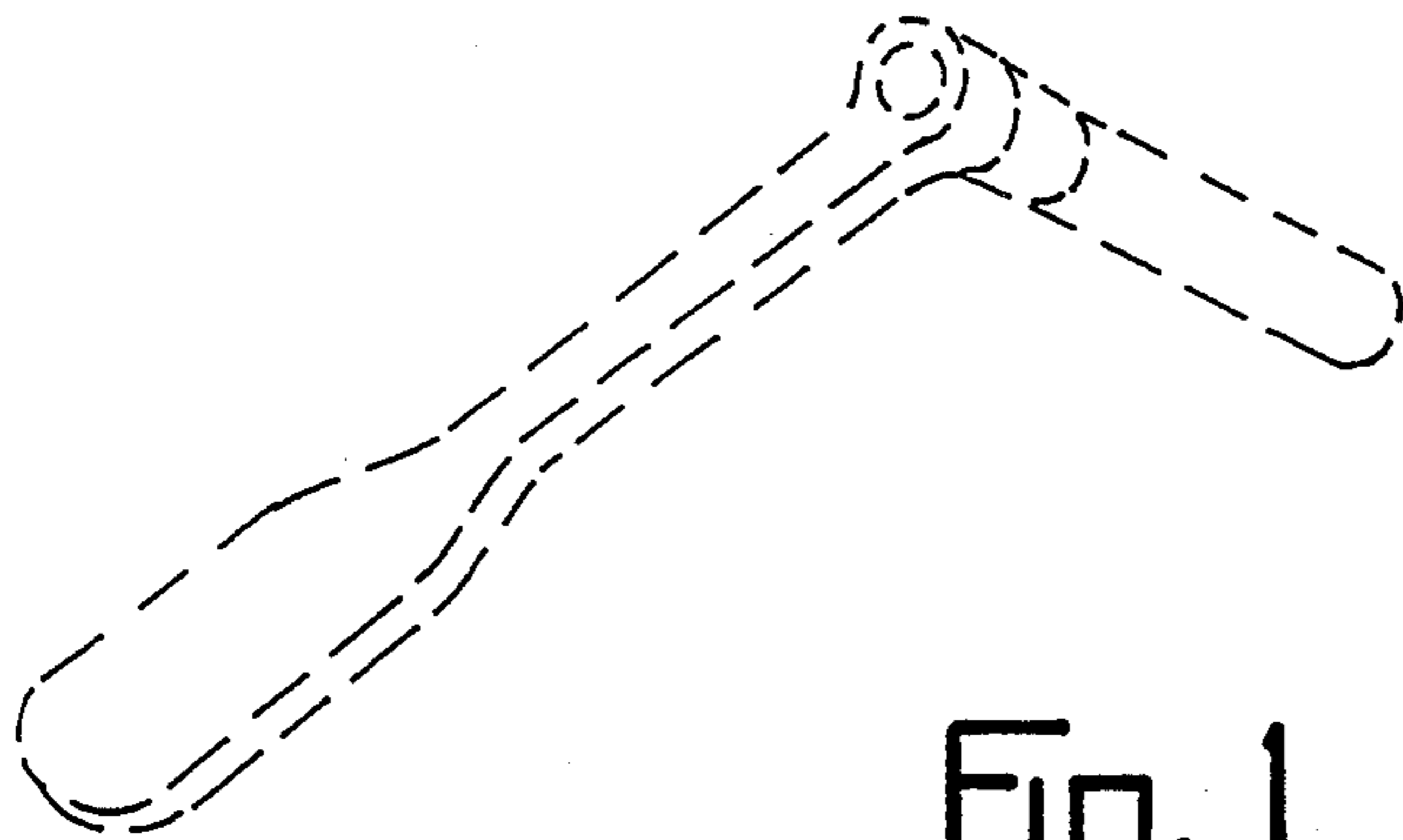

Fig. 1

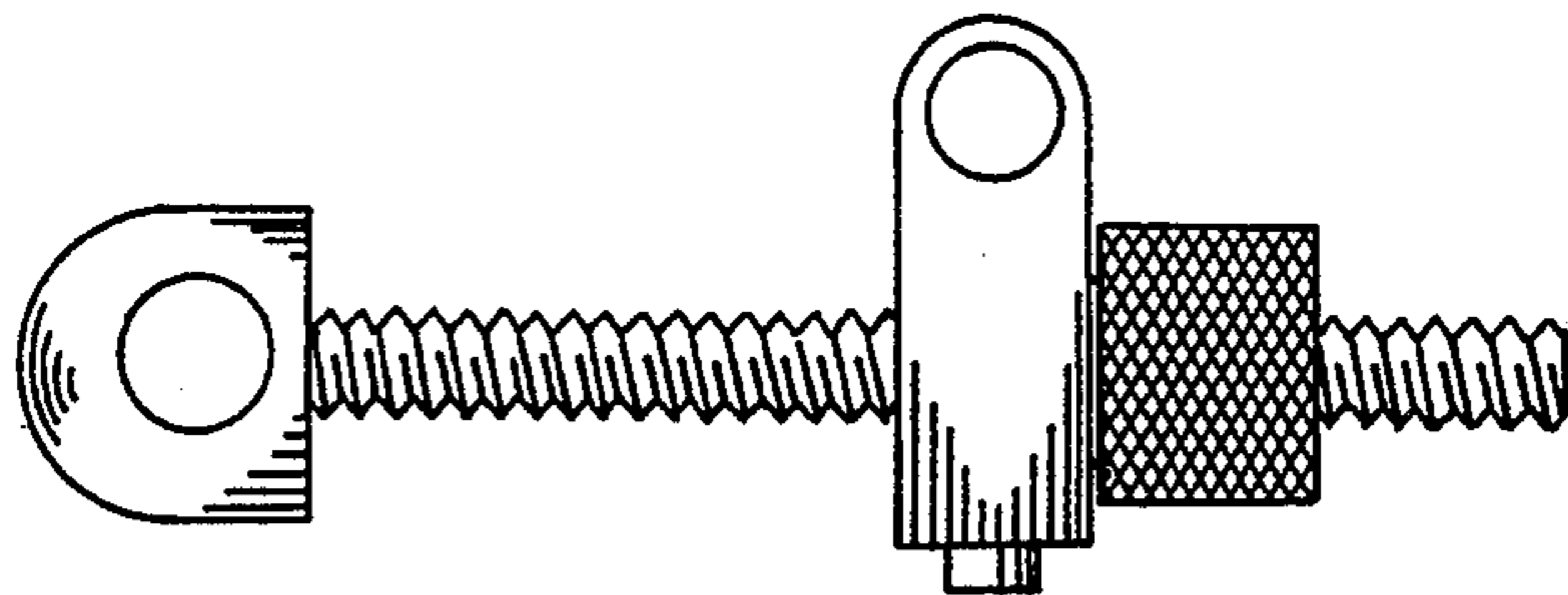
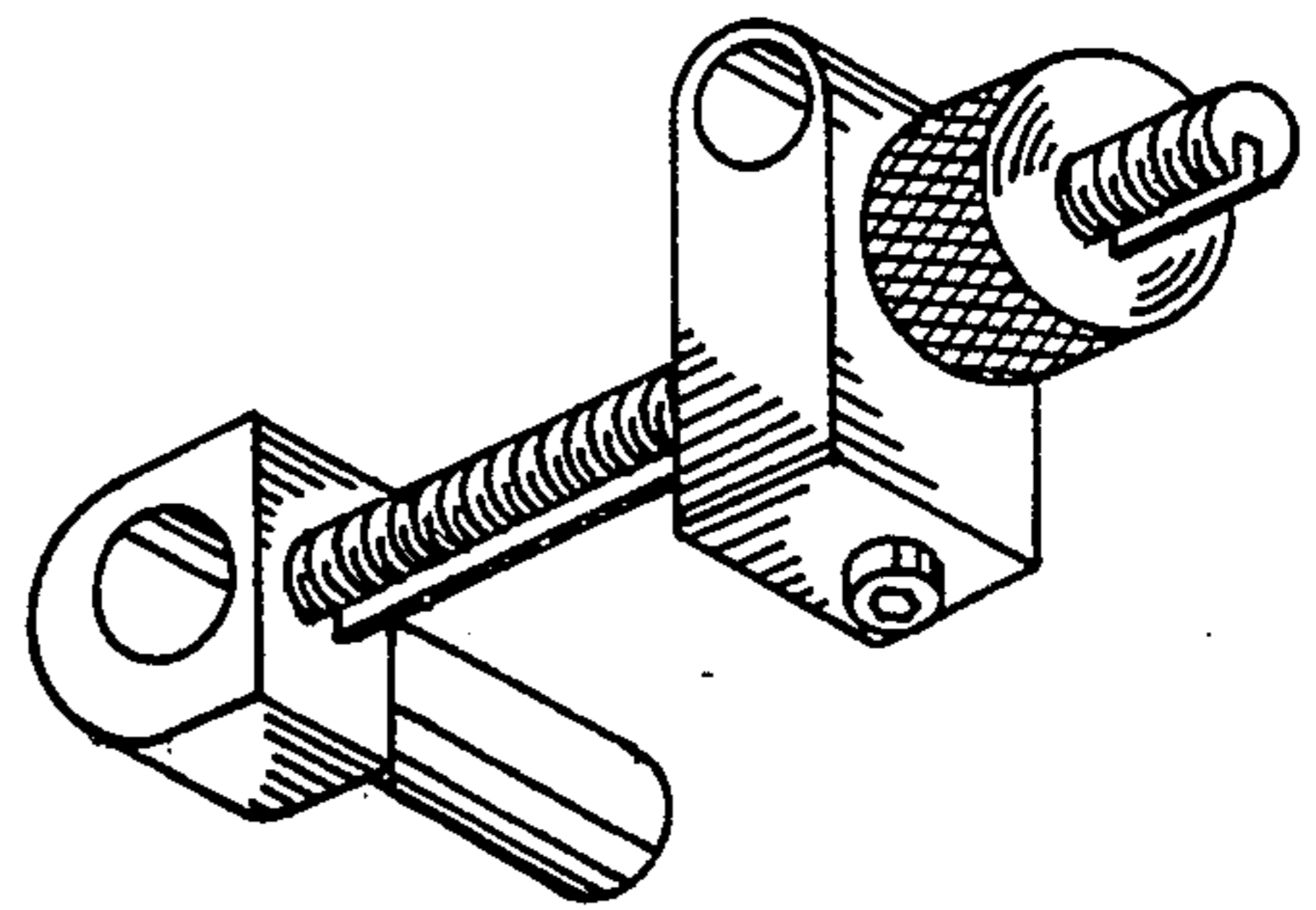

Fig. 3

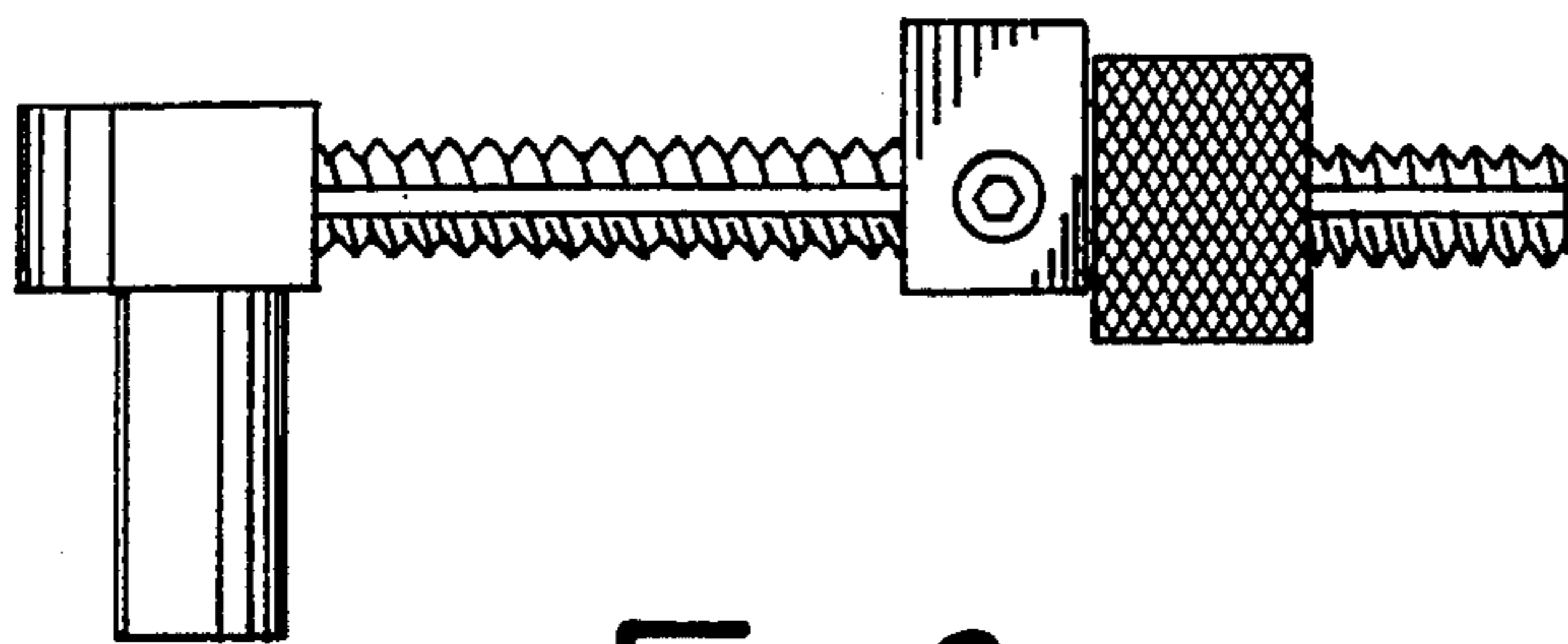

Fig. 2

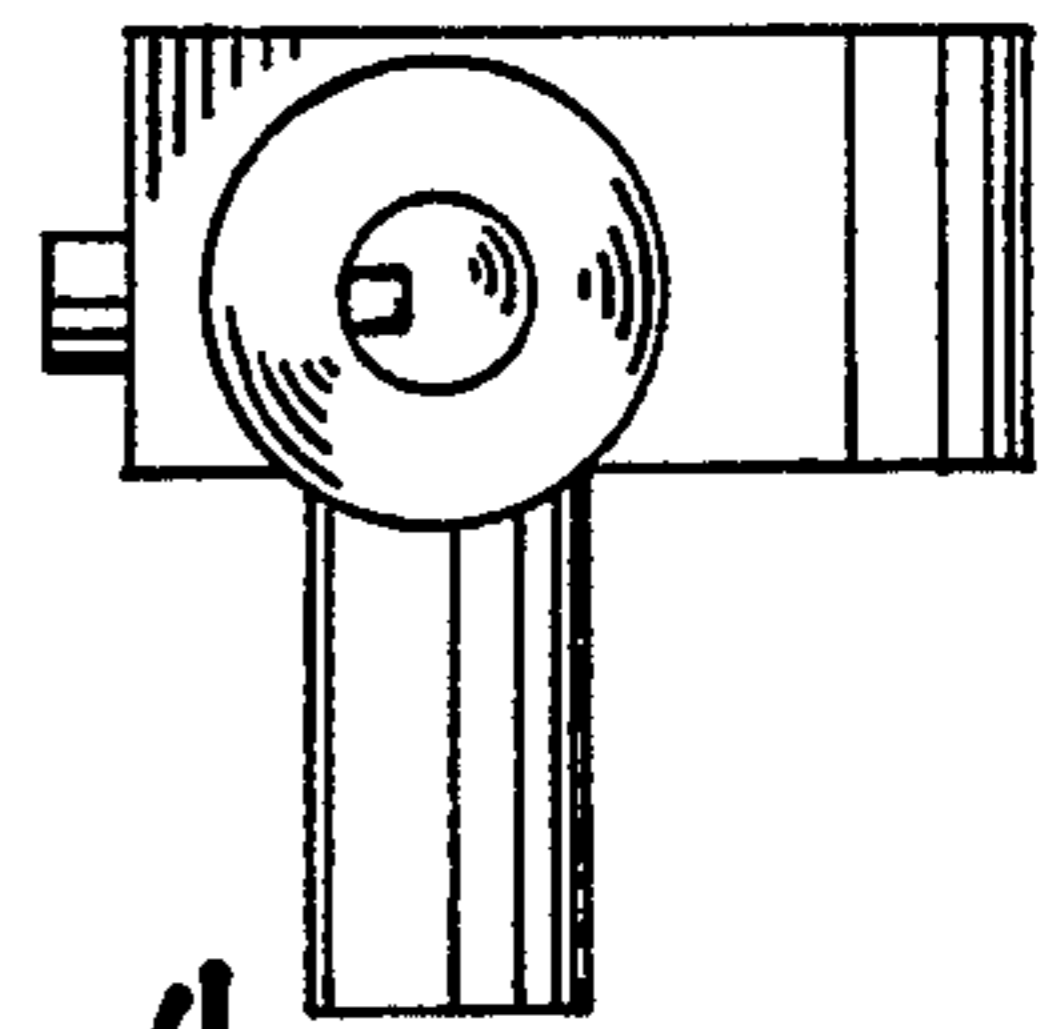

Fig. 4

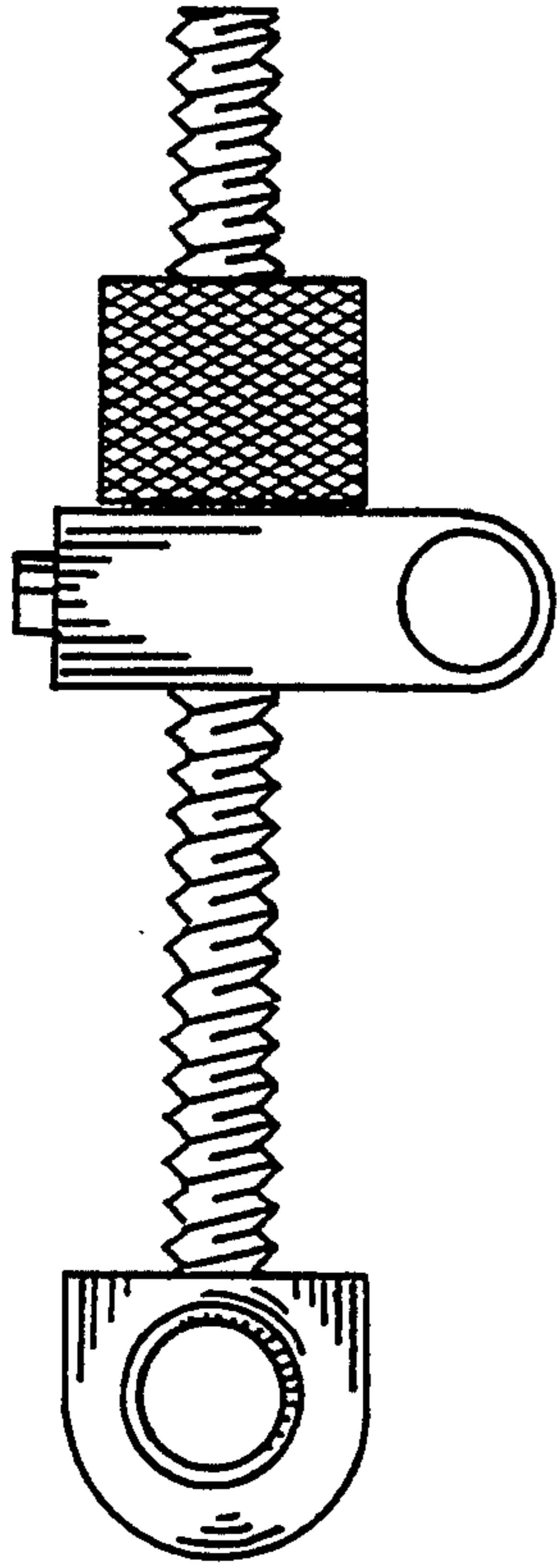

FIG. 7

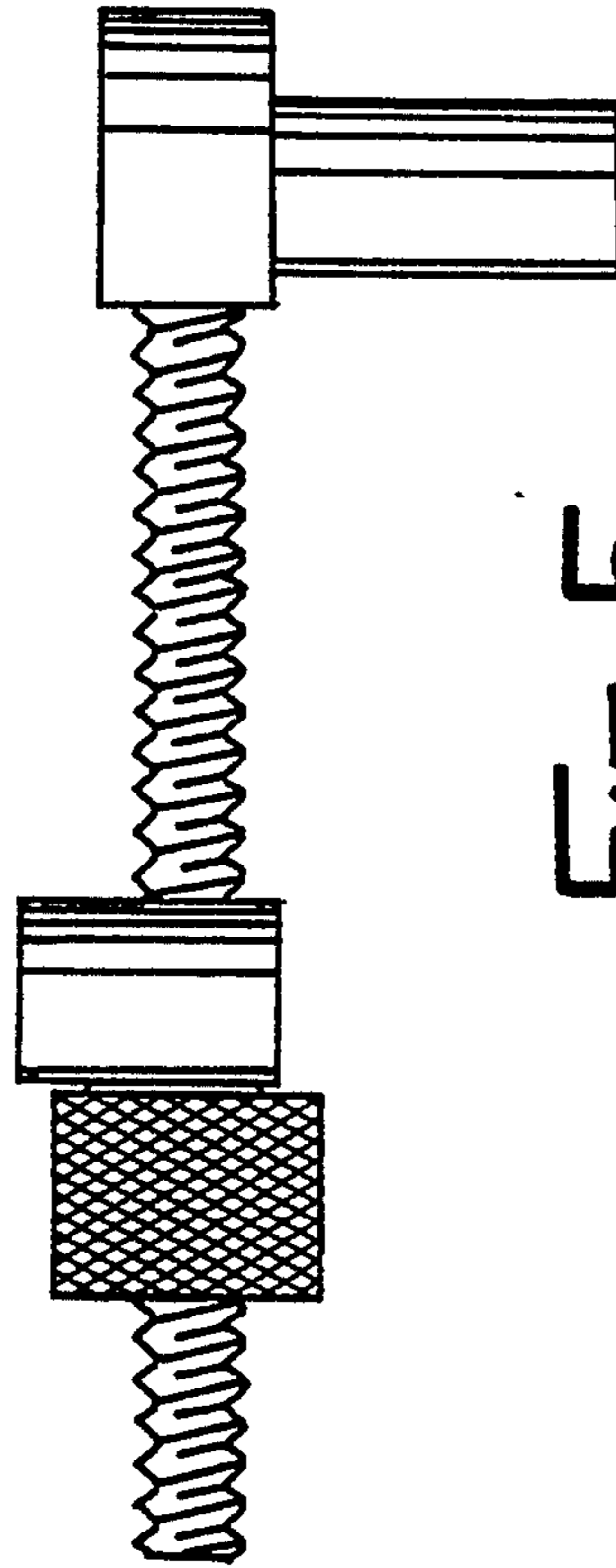

FIG. 5

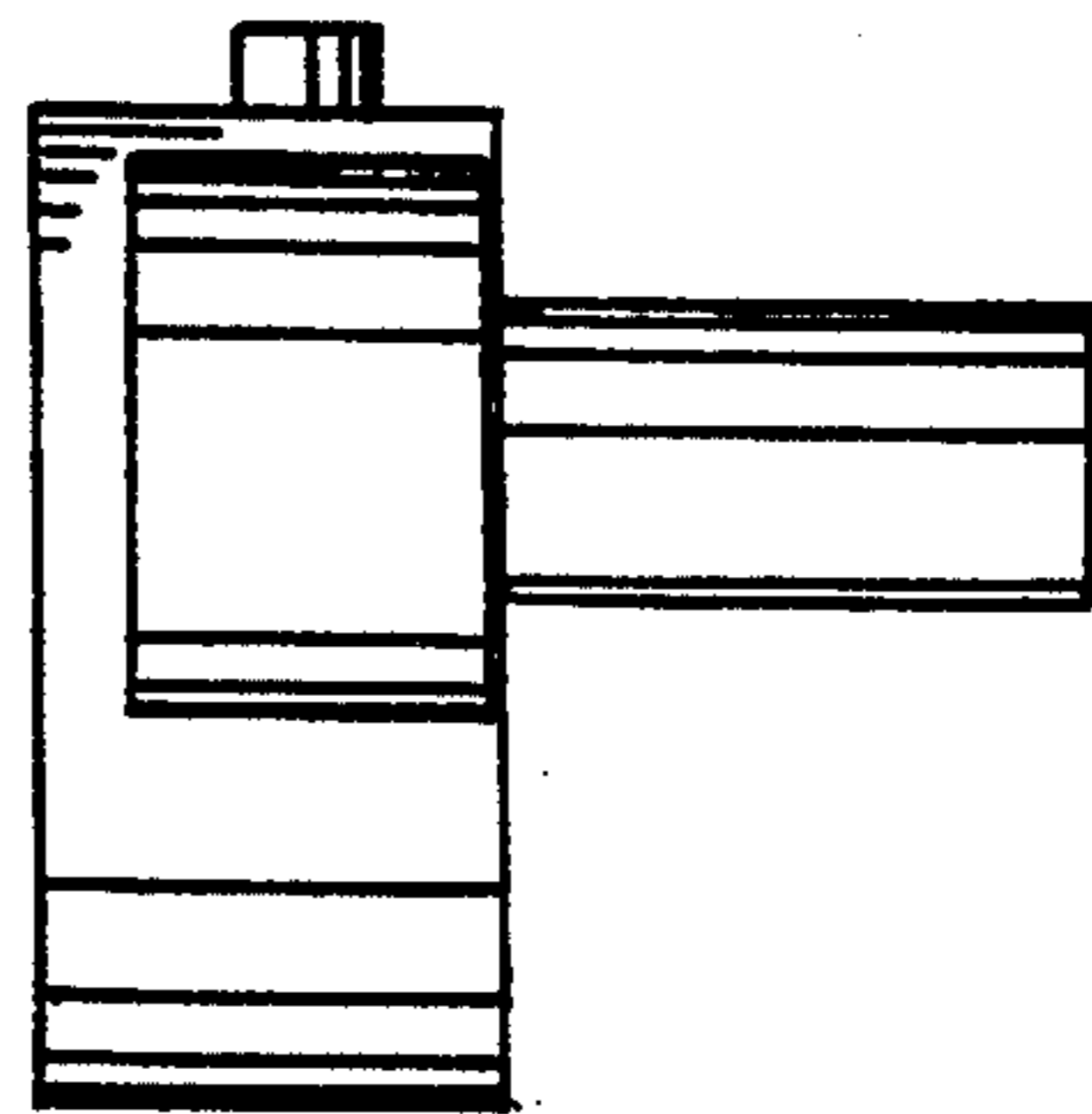

FIG. 6