



US00D354605S

# United States Patent [19]

[11] Patent Number: **Des. 354,605**

Lucky, Sr.

[45] Date of Patent: **\*\* Jan. 17, 1995**

[54] **GRAPPLER**

Primary Examiner—Kay H. Chin

[76] Inventor: **Bobby D. Lucky, Sr.**, Rte. 1 Box 160,  
Bain Rd. N.W., Athens, Ala. 35611

[57] **CLAIM**

The ornamental design for a grappler, as shown and described.

[\*\*] Term: **14 Years**

[21] Appl. No.: **896,356**

### DESCRIPTION

[22] Filed: **Jun. 12, 1992**

[52] U.S. Cl. .... **D34/35**

[58] Field of Search ..... **D34/28, 33, 34, 35;**  
**414/729, 739, 738; 294/88**

FIG. 1 is a top and front perspective view of a grappler showing my new design;

FIG. 2 is a fragmentary sectional view taken along line 2—2 of FIG. 1, of one side of a tine of the grappler;

FIG. 3 is a fragmentary bottom plan view thereof with the stopping plate attached;

FIG. 4 is an enlarged perspective view of the interior walls of the grappler;

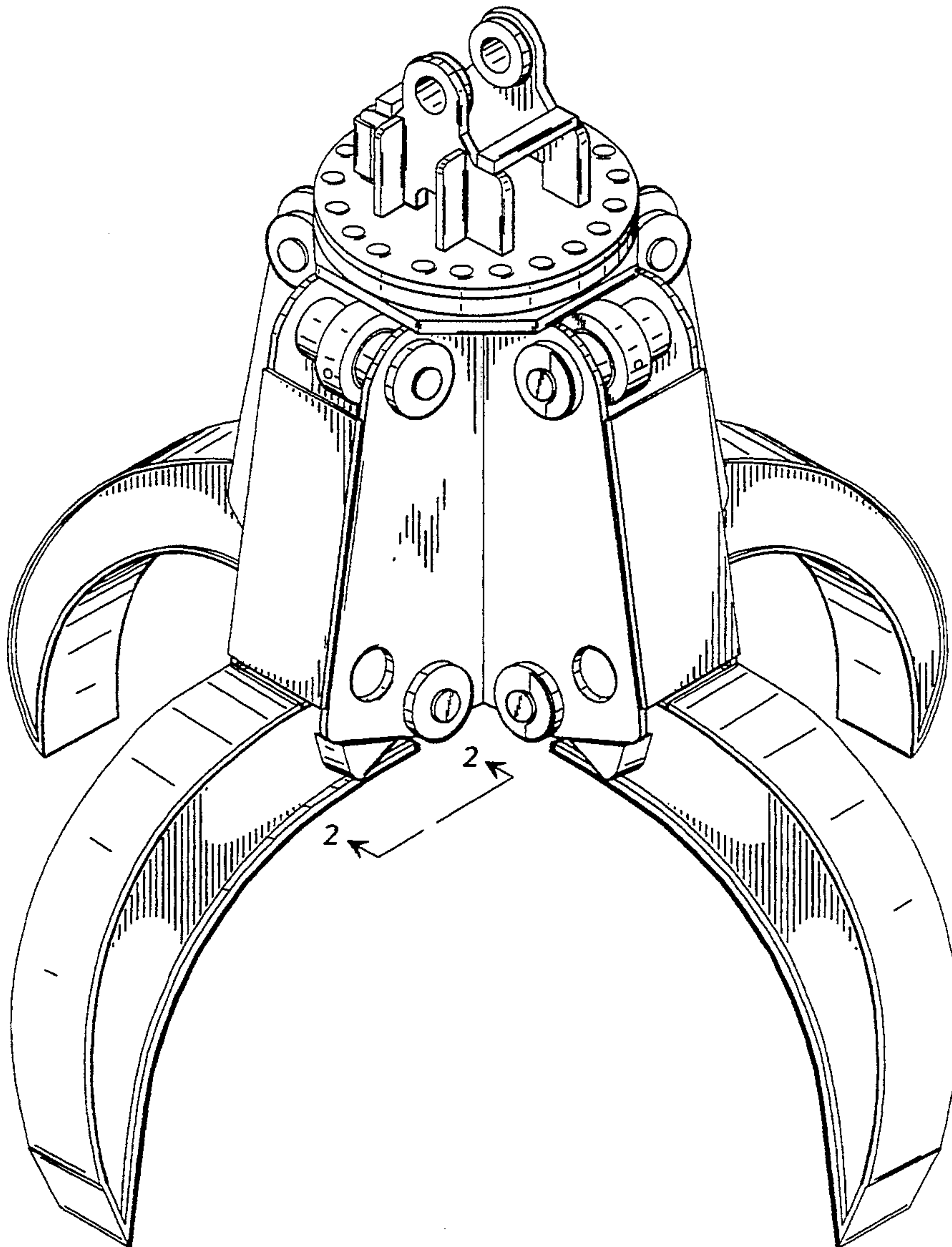
FIG. 5 is a bottom plan view thereof without stopping plate attached; and,

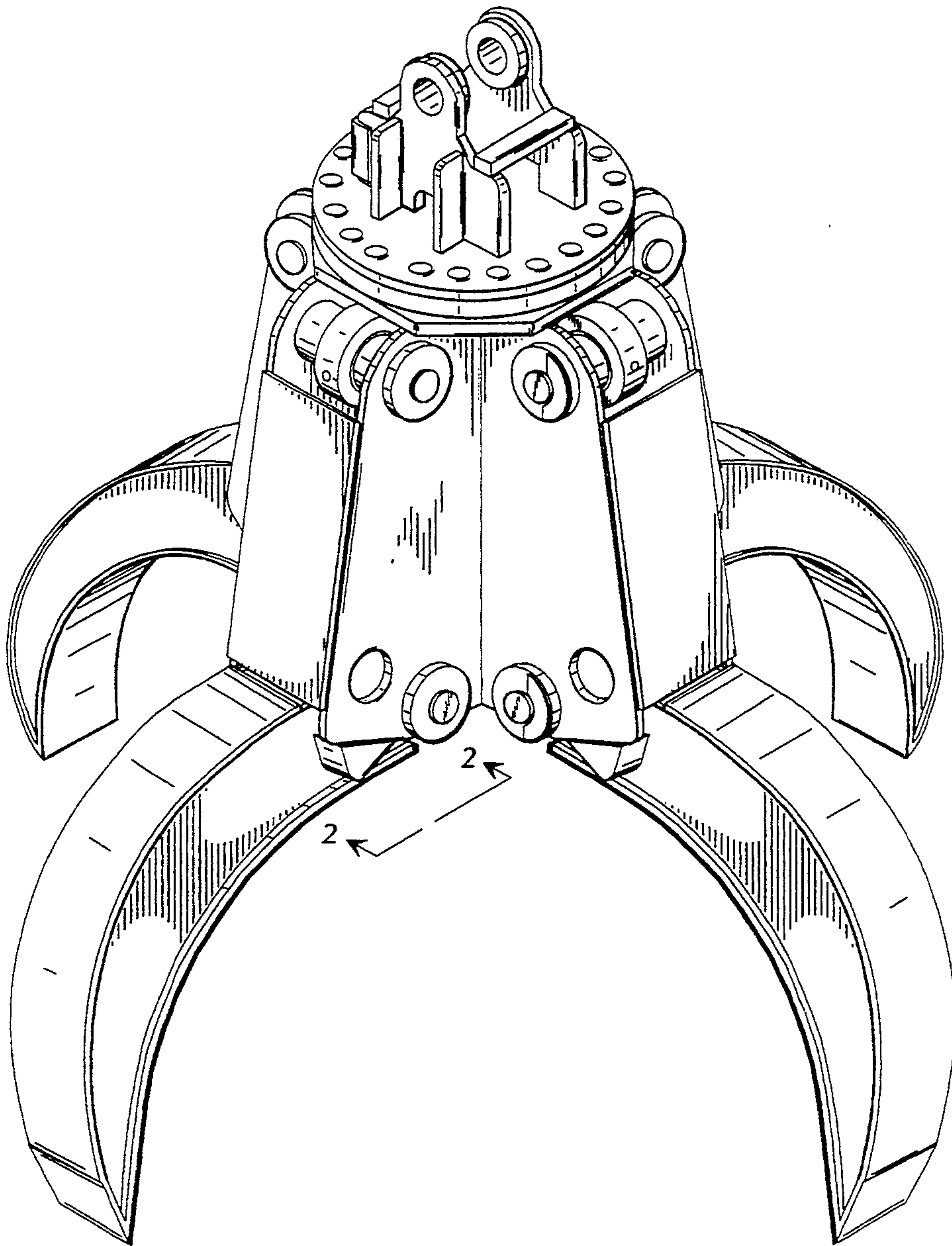
FIG. 6 is a top and rear perspective view thereof.

### [56] References Cited

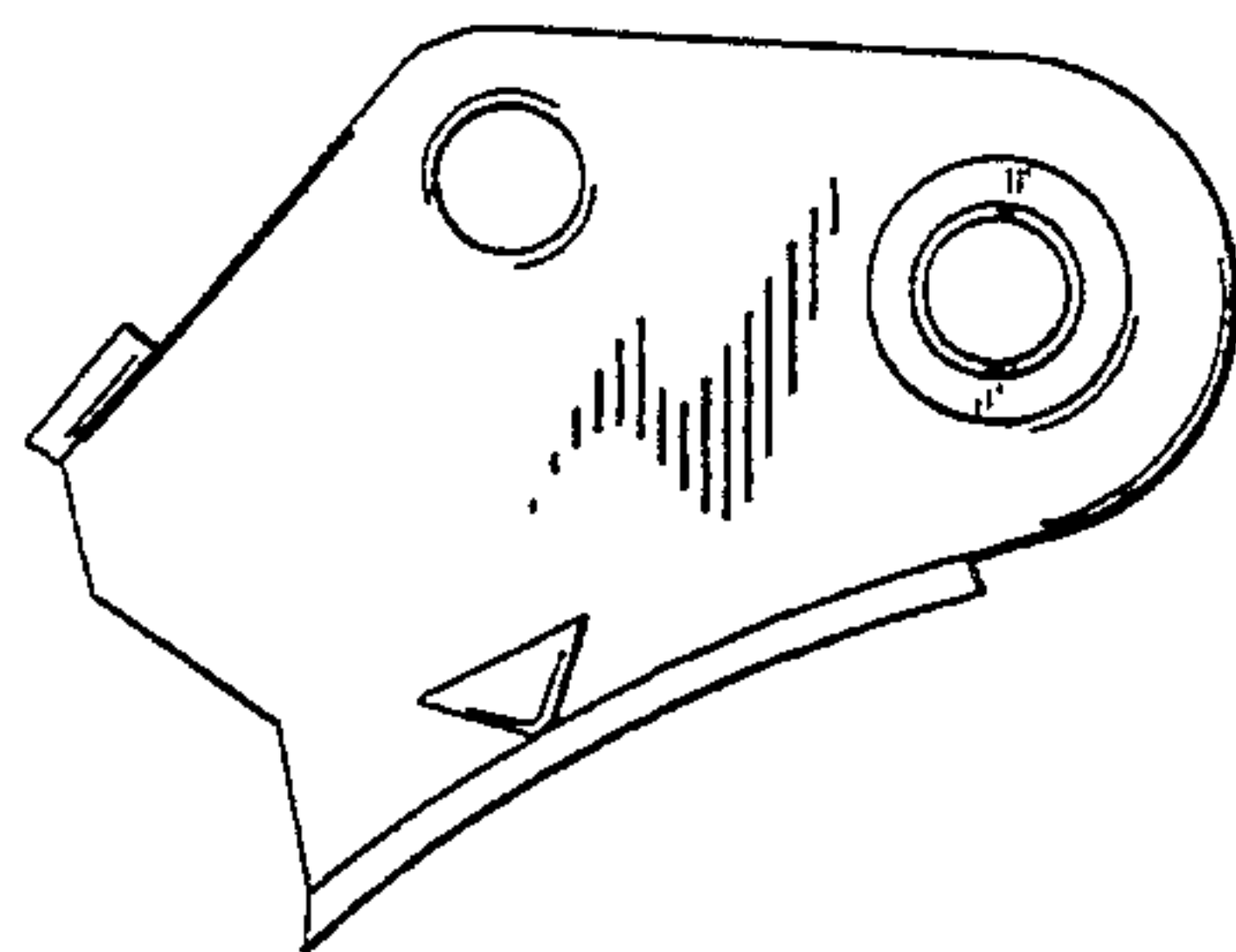
#### U.S. PATENT DOCUMENTS

|            |         |           |       |         |
|------------|---------|-----------|-------|---------|
| D. 189,049 | 10/1960 | McElderry | ..... | D34/35  |
| 4,005,894  | 2/1977  | Tucek     | ..... | 414/739 |
| 4,023,848  | 5/1977  | Bennett   | ..... | 414/739 |
| 4,897,014  | 1/1990  | Tietze    | ..... | 414/729 |

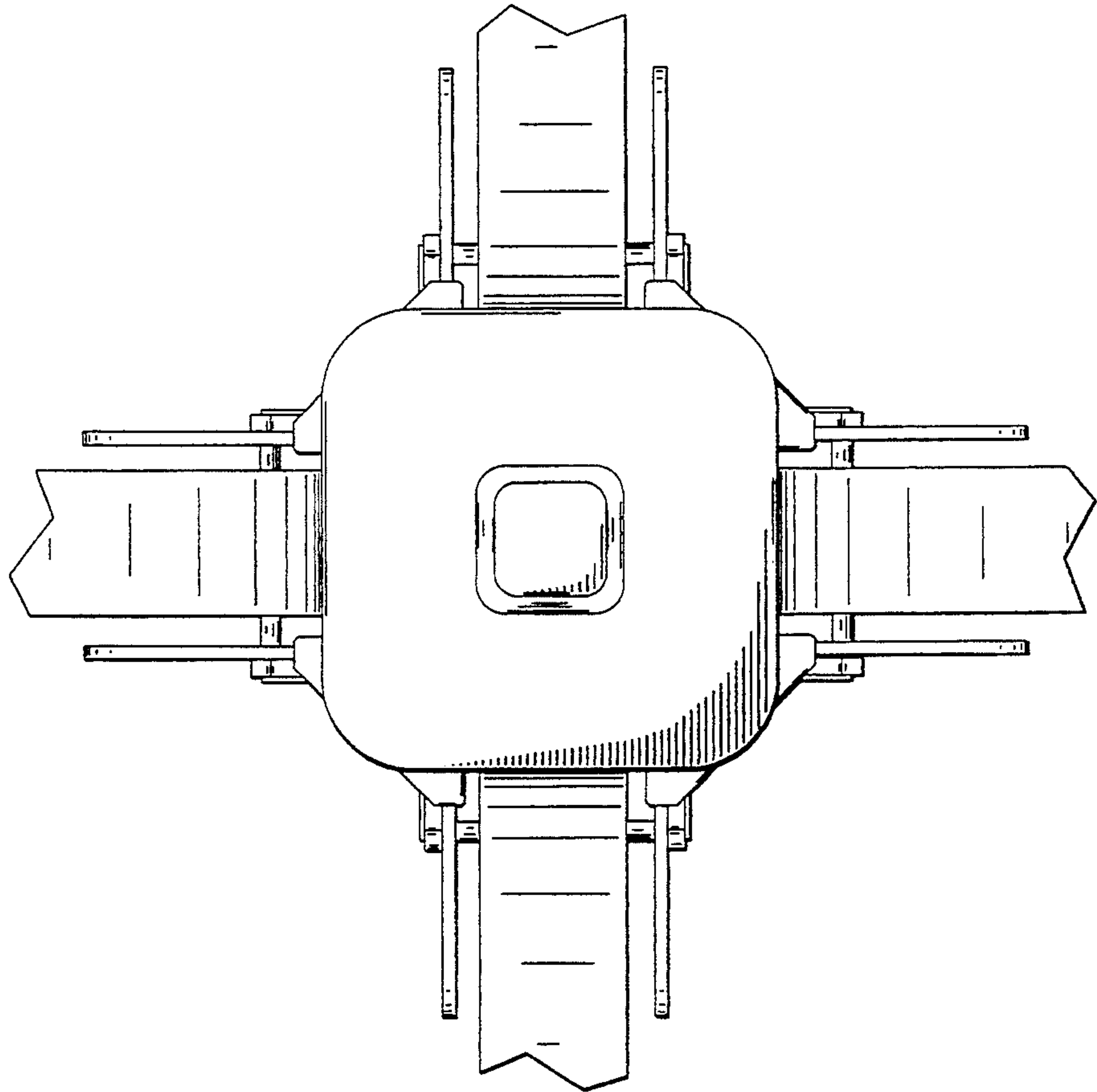




**FIG. 1**

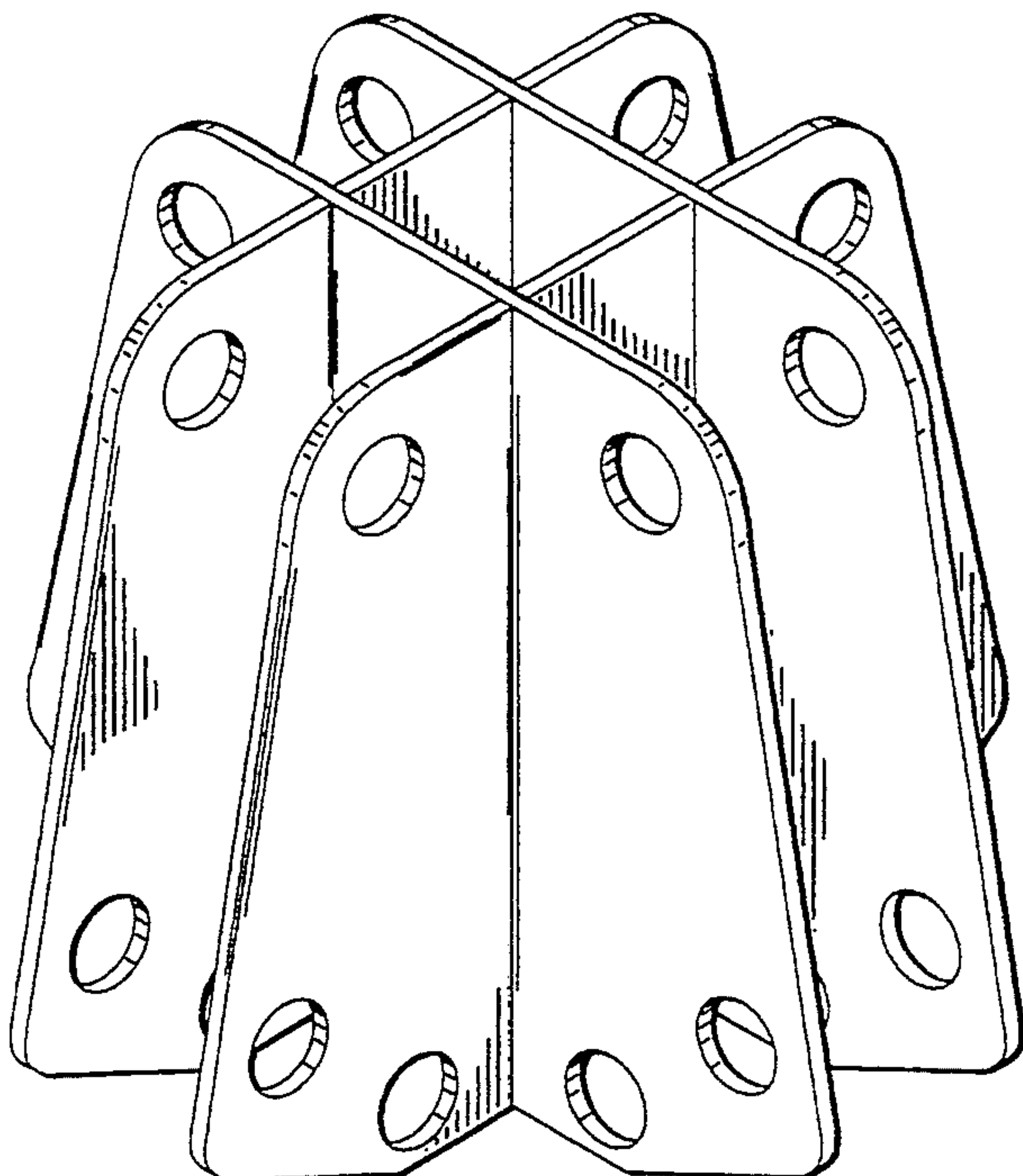


**FIG. 2**

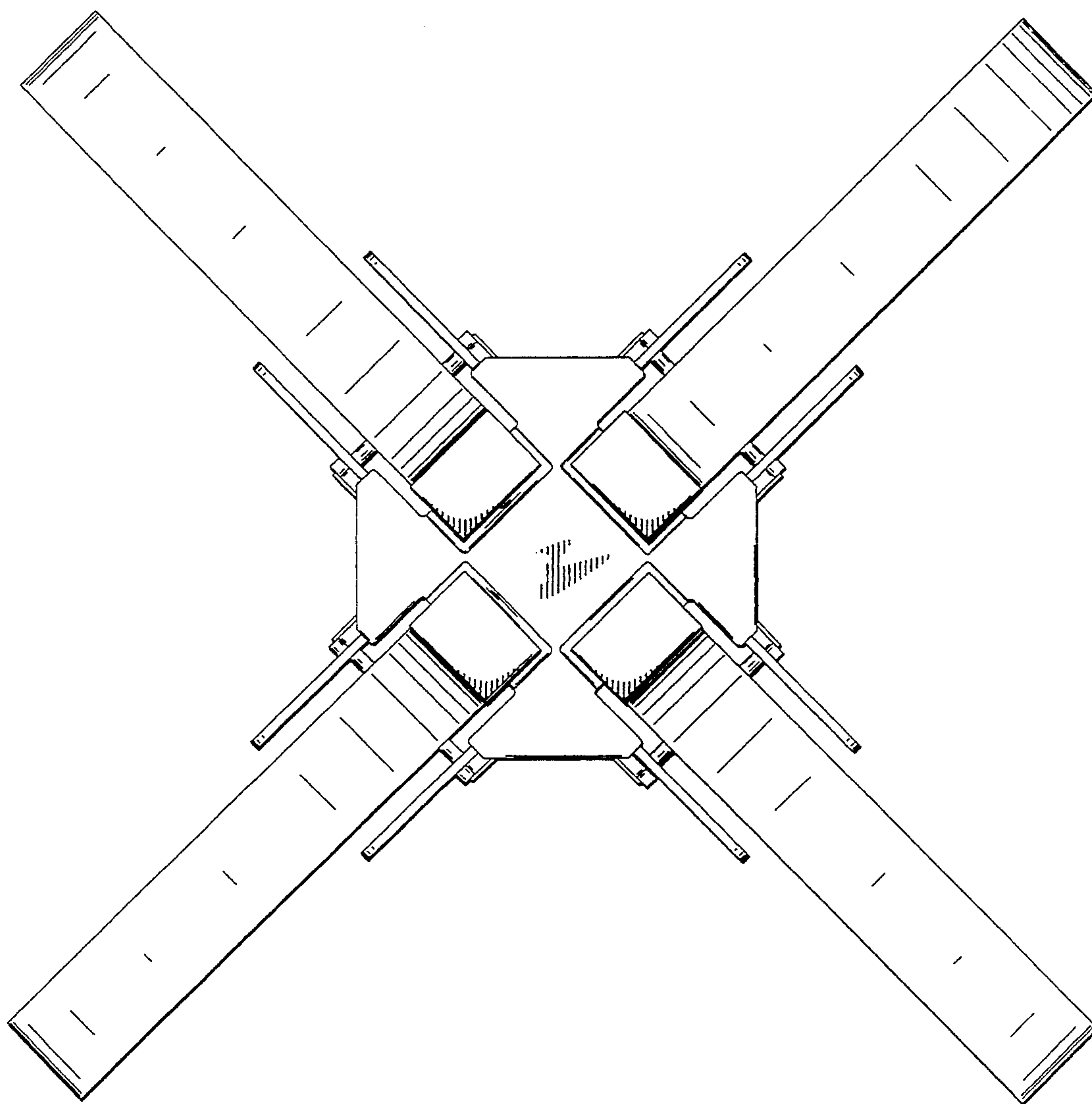


**FIG. 3**

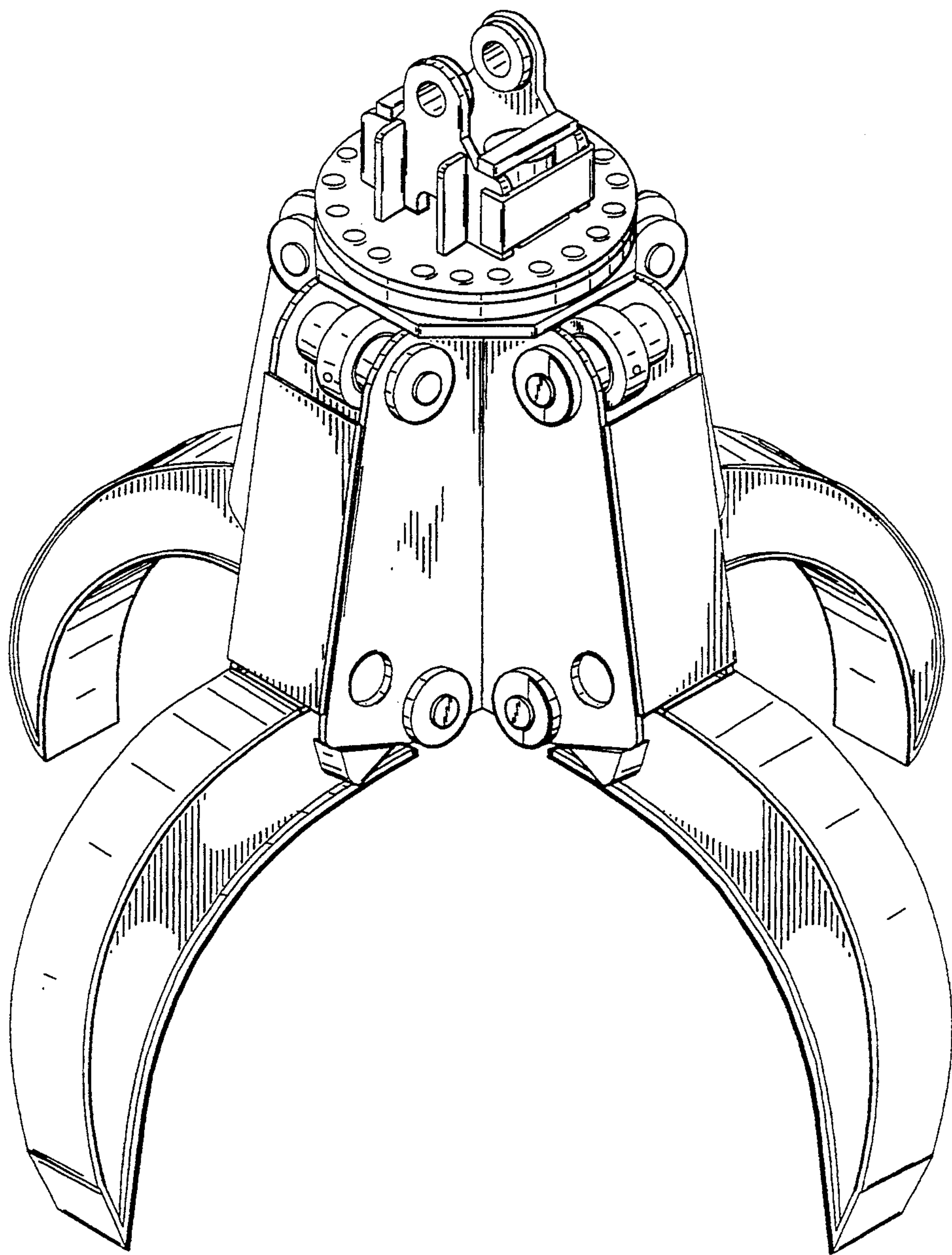
**FIG. 4**







**FIG. 5**



**FIG. 6**