



US00D354555S

United States Patent [19]

[11] Patent Number: **Des. 354,555**

Salach et al.

[45] Date of Patent: **** Jan. 17, 1995**

[54] **BATHTUB**

[75] Inventors: **Kenneth Salach, Granger, Ind.;**
Gregory Salach, Western Springs, Ill.

[73] Assignee: **G.K.L. Corporation, Romeoville, Ill.**

[**] Term: **14 Years**

[21] Appl. No.: **6,356**

[22] Filed: **Mar. 26, 1993**

[52] U.S. Cl. **D23/277**

[58] Field of Search **D23/270, 275, 277-283;**
D24/203-205; 4/538, 571.1, 572.1, 578.1, 579,
584, 586, 589, 590, 611

2,813,276	11/1957	Lanza	4/579
3,359,574	12/1967	Stoneburner .	
3,740,908	6/1973	Moore .	
4,299,064	10/1981	Daniels .	
4,423,528	1/1984	Wiedmeier .	
4,578,832	4/1986	Primucci .	
4,671,026	6/1987	Wissinger .	
4,825,480	5/1989	Moore .	
4,897,889	2/1990	Baus .	
4,901,380	2/1990	Smith .	
4,981,164	1/1991	Reichel .	

Primary Examiner—James R. Largen
Attorney, Agent, or Firm—Patula & Associates

[57] CLAIM

The ornamental design for a bathtub, as shown and described.

[56] References Cited

U.S. PATENT DOCUMENTS

D. 93,716	10/1934	Hesler	D23/281
D. 241,643	9/1976	Bonsack	D23/281
D. 255,262	6/1980	Beddome et al.	D23/281
D. 266,692	10/1982	Harrison	D23/281
D. 275,782	10/1984	Burgess et al.	D23/282
D. 295,665	5/1988	Salach	D23/277
D. 300,556	4/1989	Delepine	D23/281
D. 318,323	7/1991	Stairs, Jr.	D23/277
D. 319,490	8/1991	Stairs, Jr.	D23/277
1,739,163	12/1929	Mitchell	D23/275 X
2,143,034	1/1939	Sakier .	
2,236,927	4/1941	Thomas	4/579
2,396,845	3/1946	Gruen .	

DESCRIPTION

FIG. 1 is an exploded perspective view taken from the top and front of a bathtub showing our new design; FIG. 2 is a perspective view taken from the top and front thereof, showing the seat in position; FIG. 3 is a front elevational view thereof; FIG. 4 is a rear elevational view thereof; FIG. 5 is a right side elevational view thereof; FIG. 6 is a left side elevational view thereof; FIG. 7 is a bottom plan view thereof; FIG. 8 is a top plan view of FIG. 2; and, FIG. 9 is another top plan view thereof with the seat removed for convenience of illustration.

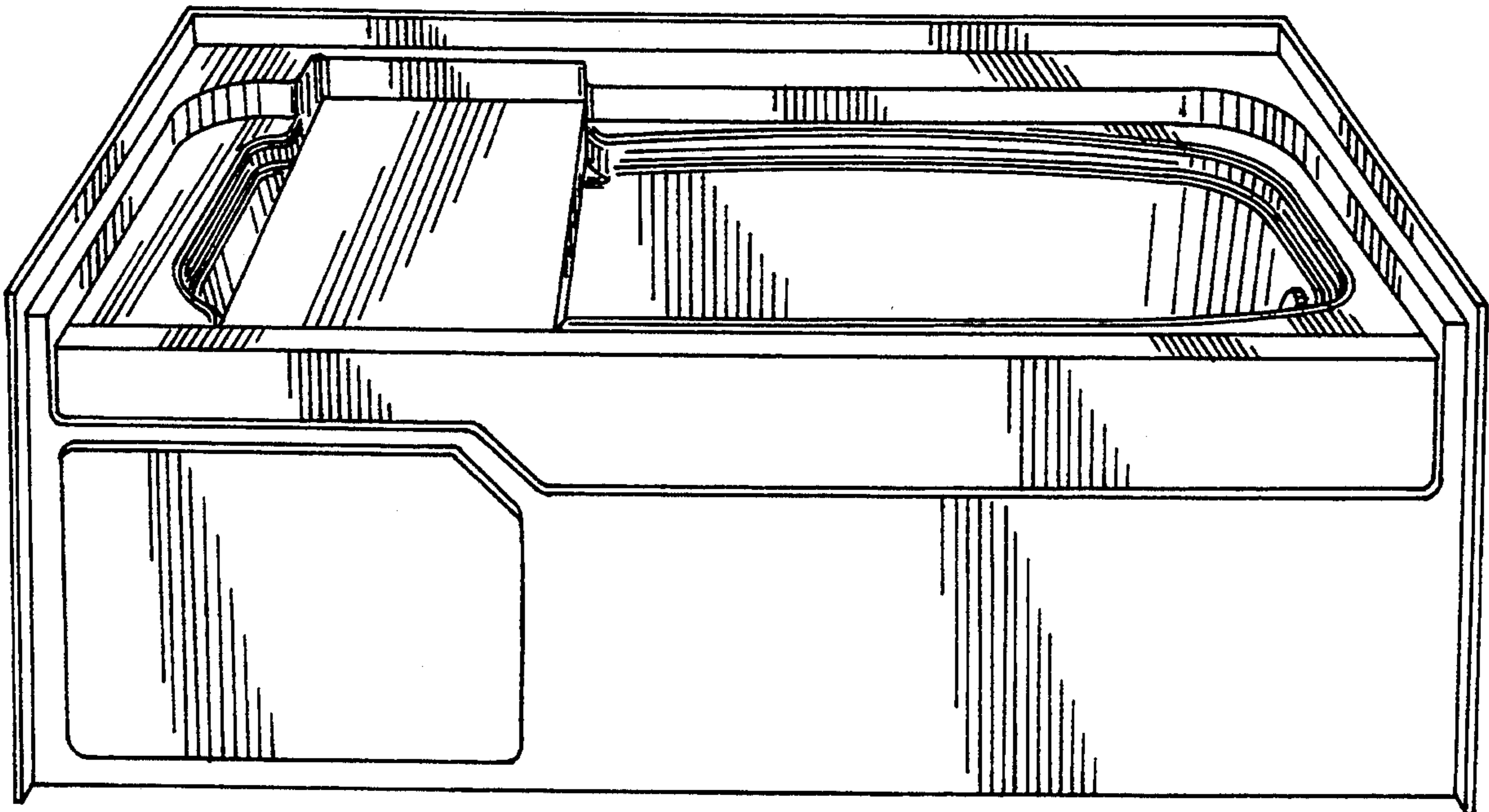

FIG. 1

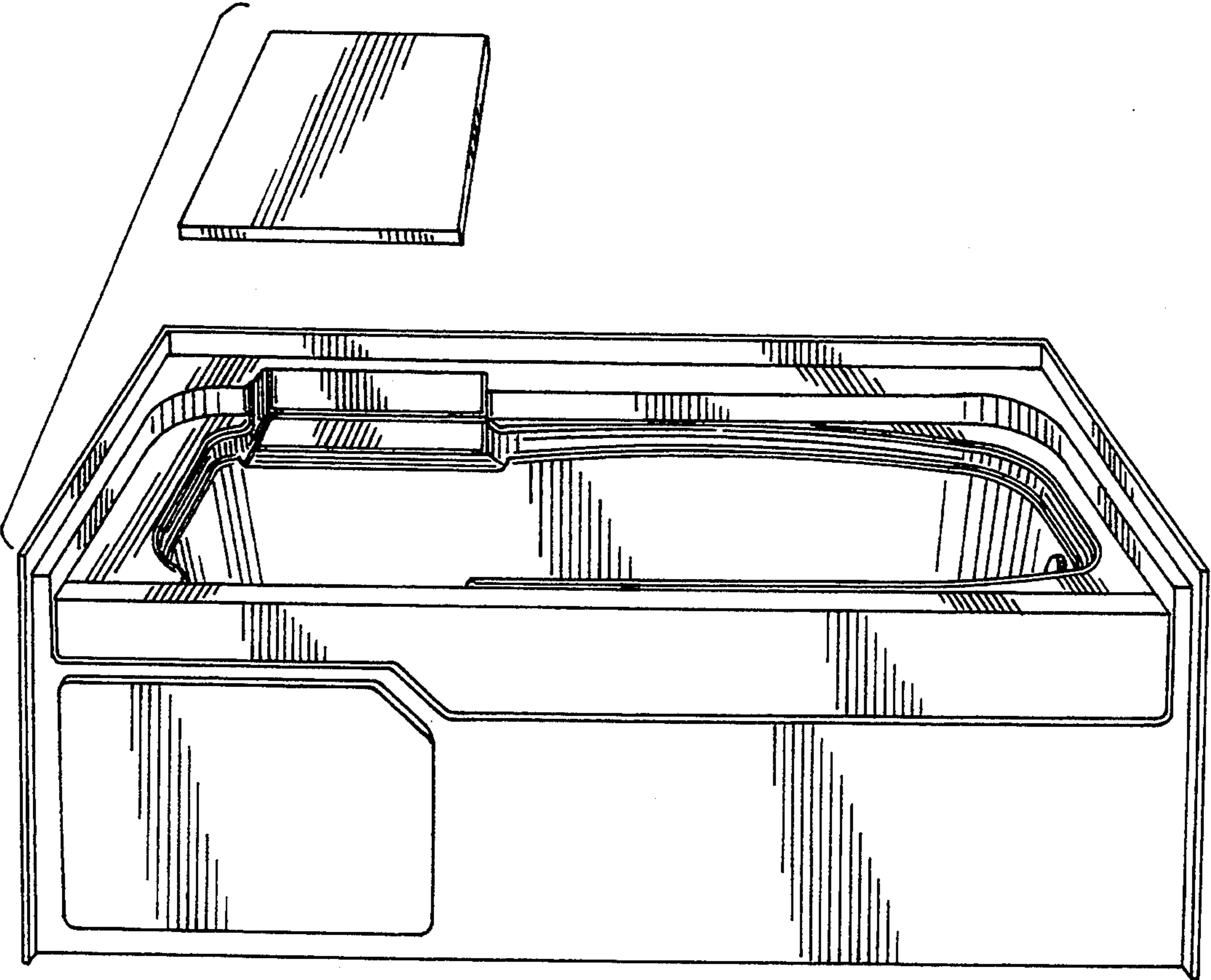

FIG. 2

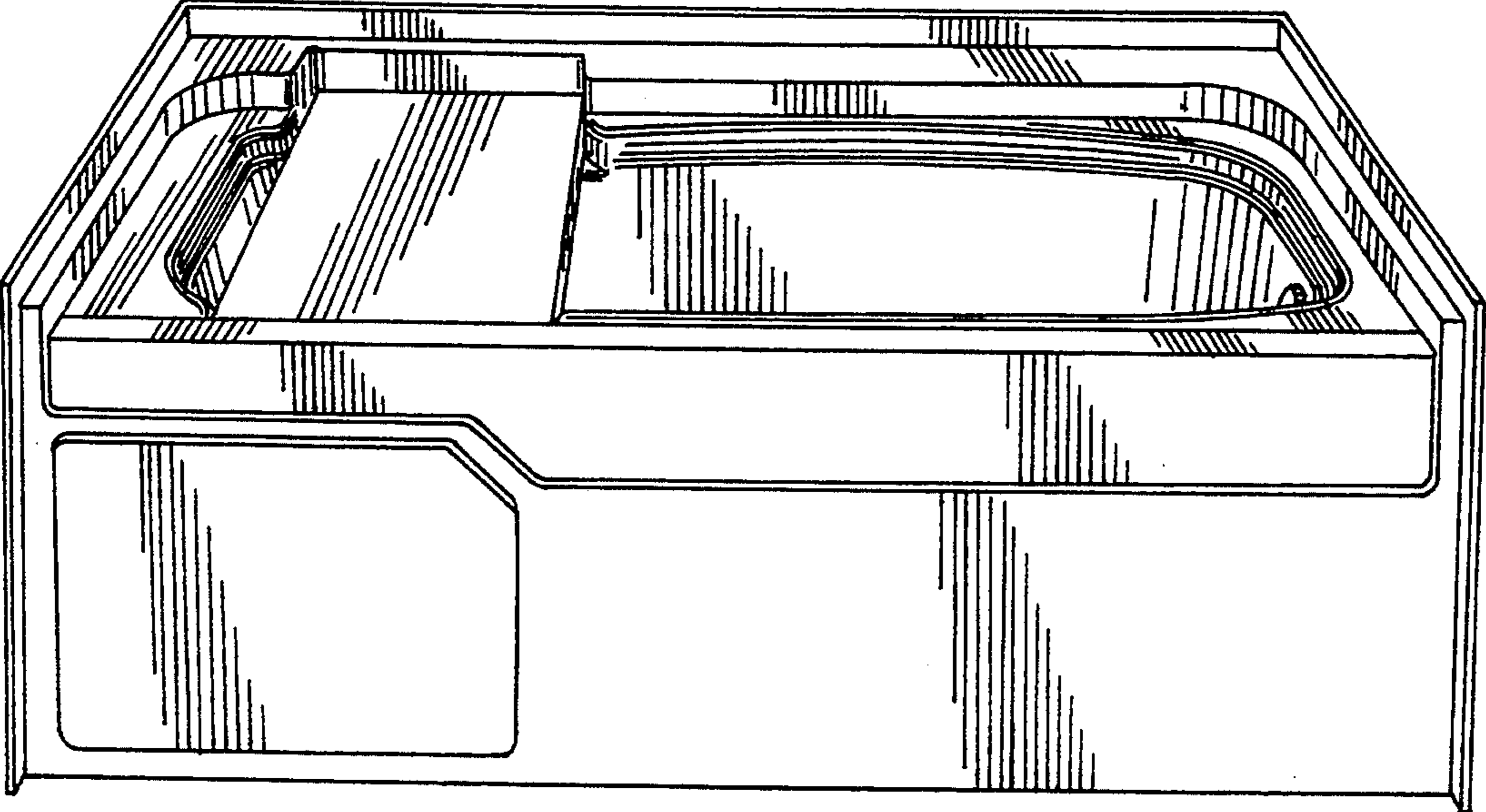

FIG.3

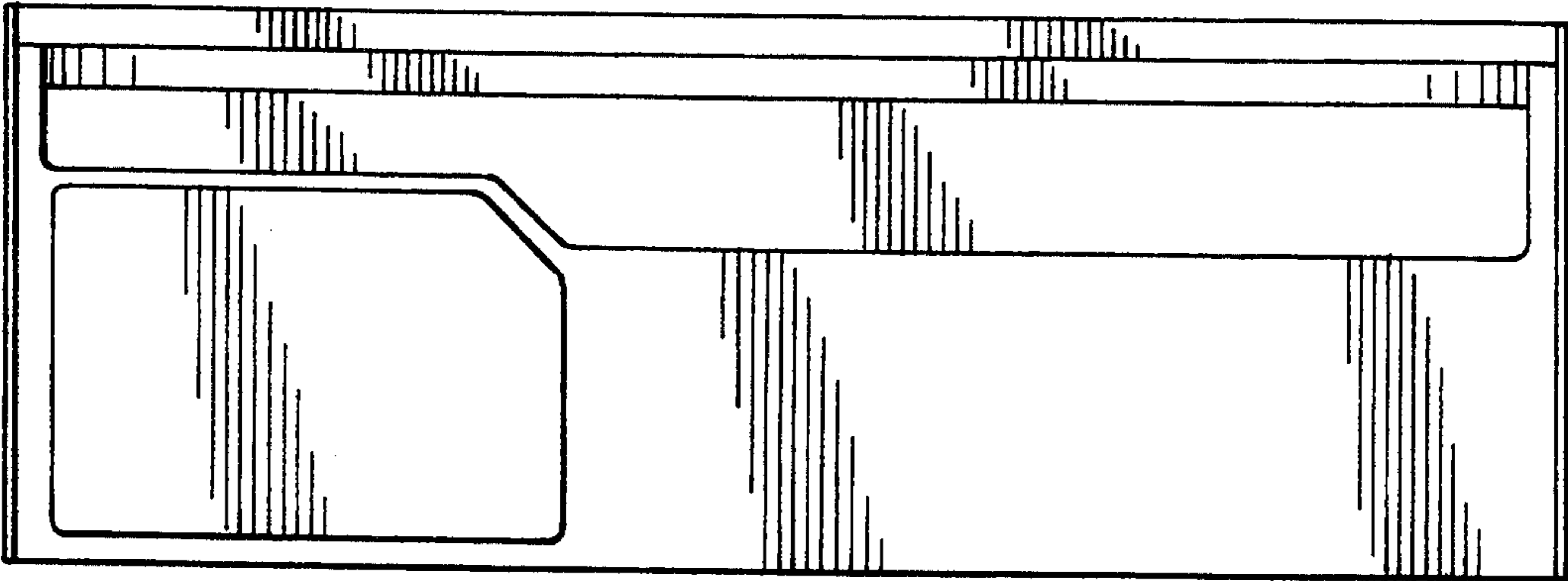

FIG.4

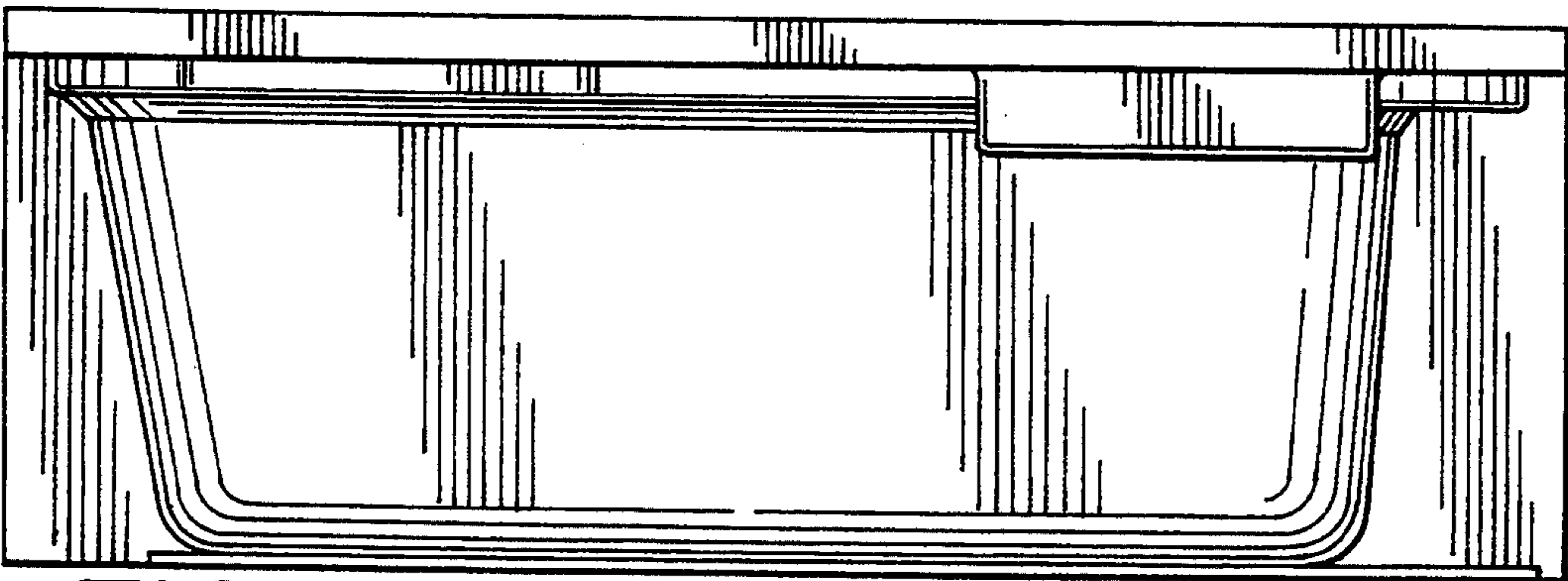

FIG.5

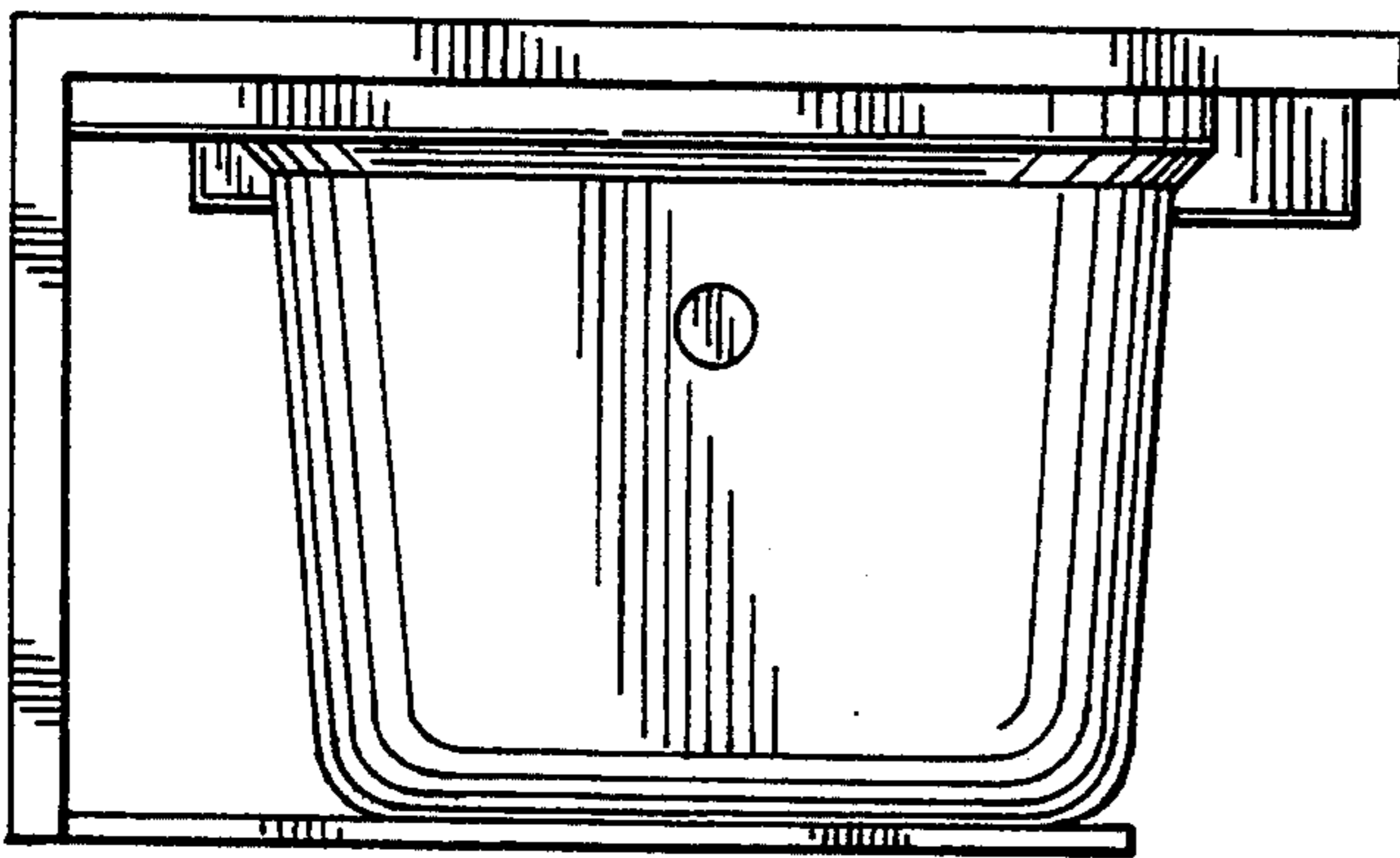

FIG.6

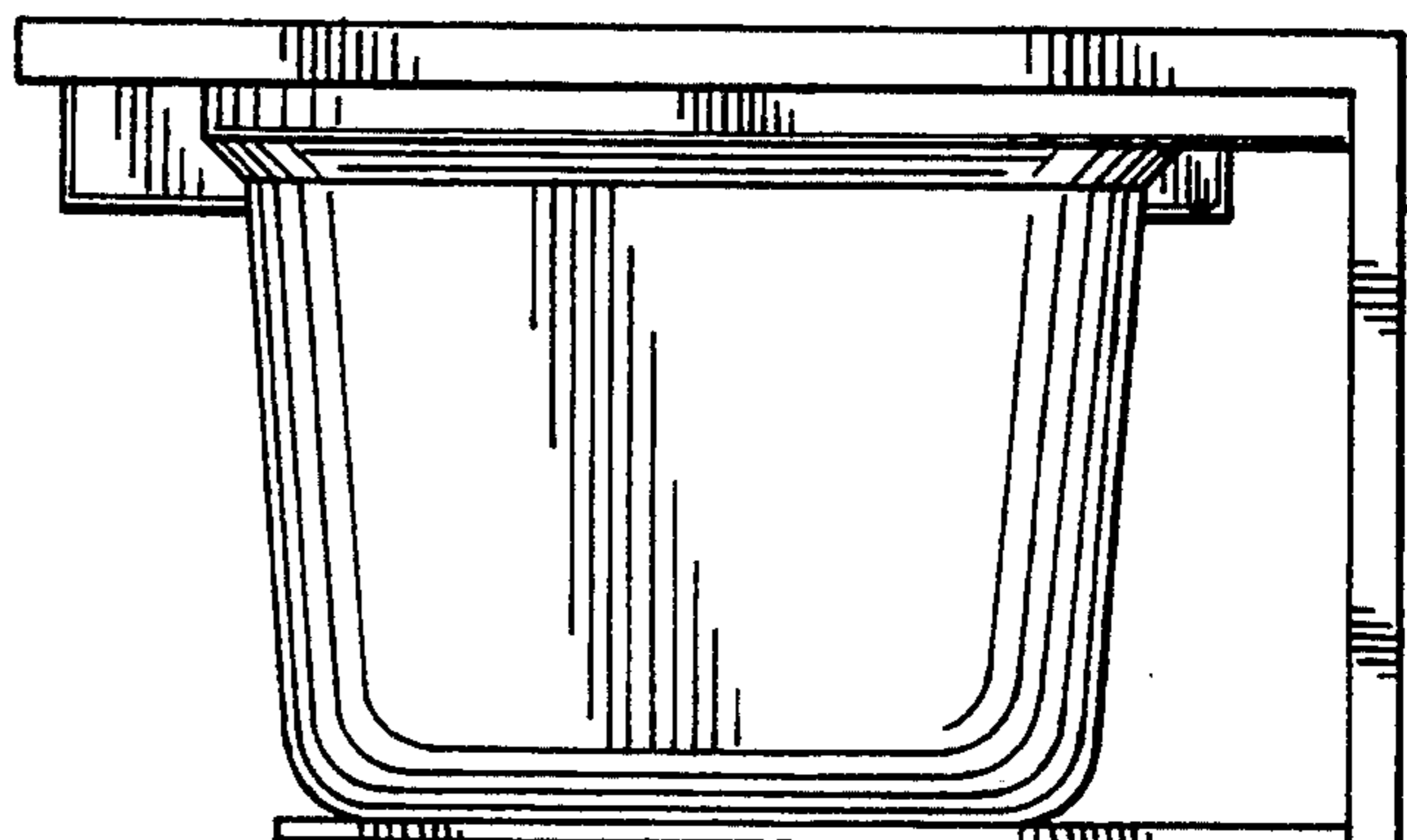

FIG. 7

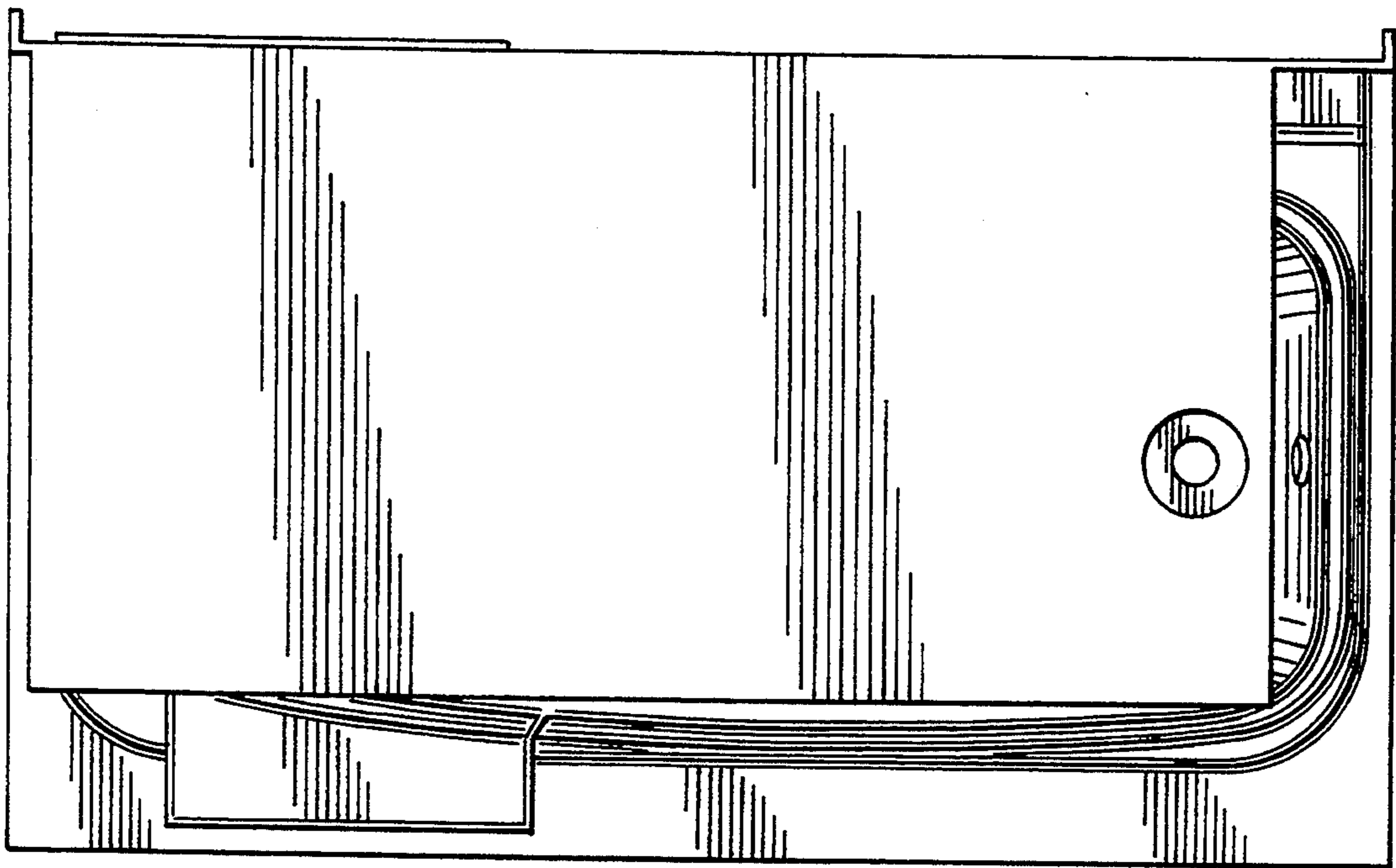

FIG. 8

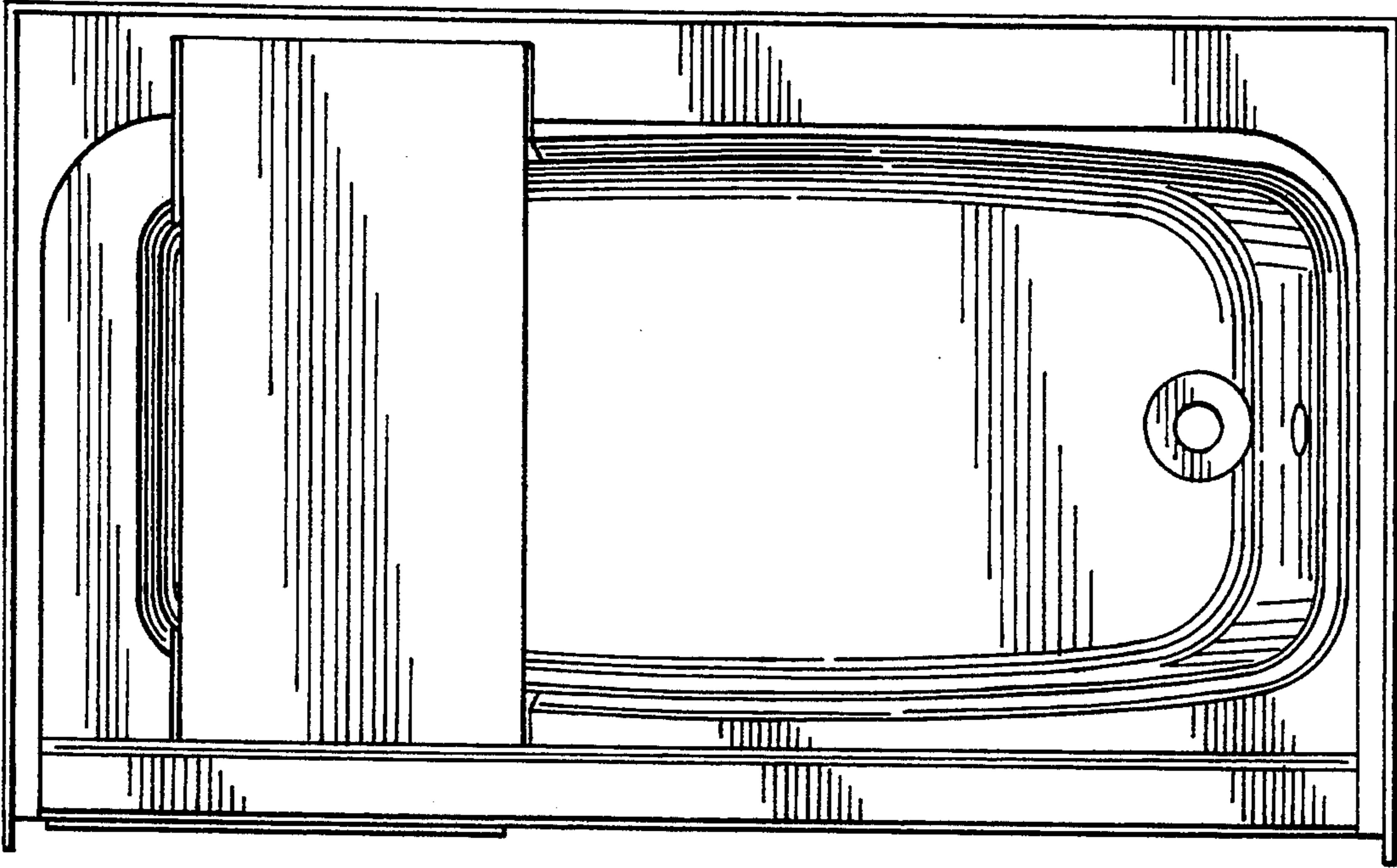

FIG. 9

