



US00D354469S

# United States Patent [19]

[11] Patent Number: **Des. 354,469**

**Powers**

[45] Date of Patent: **\*\* Jan. 17, 1995**

[54] **DISK BRAKE CALIPER HOUSING**

4,270,631	6/1981	Kobelt .....	188/71.1
5,181,588	1/1993	Emmons .....	188/71.1
5,259,483	11/1993	Pehfrey .....	188/71.1

[75] Inventor: **Ronald H. Powers**, Costa Mesa, Calif.

[73] Assignee: **Powers Design International**, Newport Beach, Calif.

*Primary Examiner*—Wallace R. Burke  
*Assistant Examiner*—M. Brown  
*Attorney, Agent, or Firm*—Lynn & Lynn

[\*\*] Term: **14 Years**

[57] **CLAIM**

[21] Appl. No.: **11,642**

The ornamental design for a disk brake caliper housing, as shown.

[22] Filed: **Aug. 9, 1993**

[52] U.S. Cl. .... **D12/180**

[58] Field of Search ..... **D12/180; 180/71.1**

**DESCRIPTION**

[56] **References Cited**

**U.S. PATENT DOCUMENTS**

D. 255,675	7/1980	Weiser et al. ....	D12/180
D. 260,014	7/1981	Sheill .....	D12/180
4,068,743	1/1978	Karasudani et al. ....	188/71.1

FIG. 1 is a top plan view showing my new design; FIG. 2 is a front perspective view elevation of my new design; FIG. 3 is a left side elevation view of my new design; FIG. 4 is a front elevation view of my new design; FIG. 5 is a bottom plan view of my new design; and, FIG. 6 is a rear perspective view of my new design.

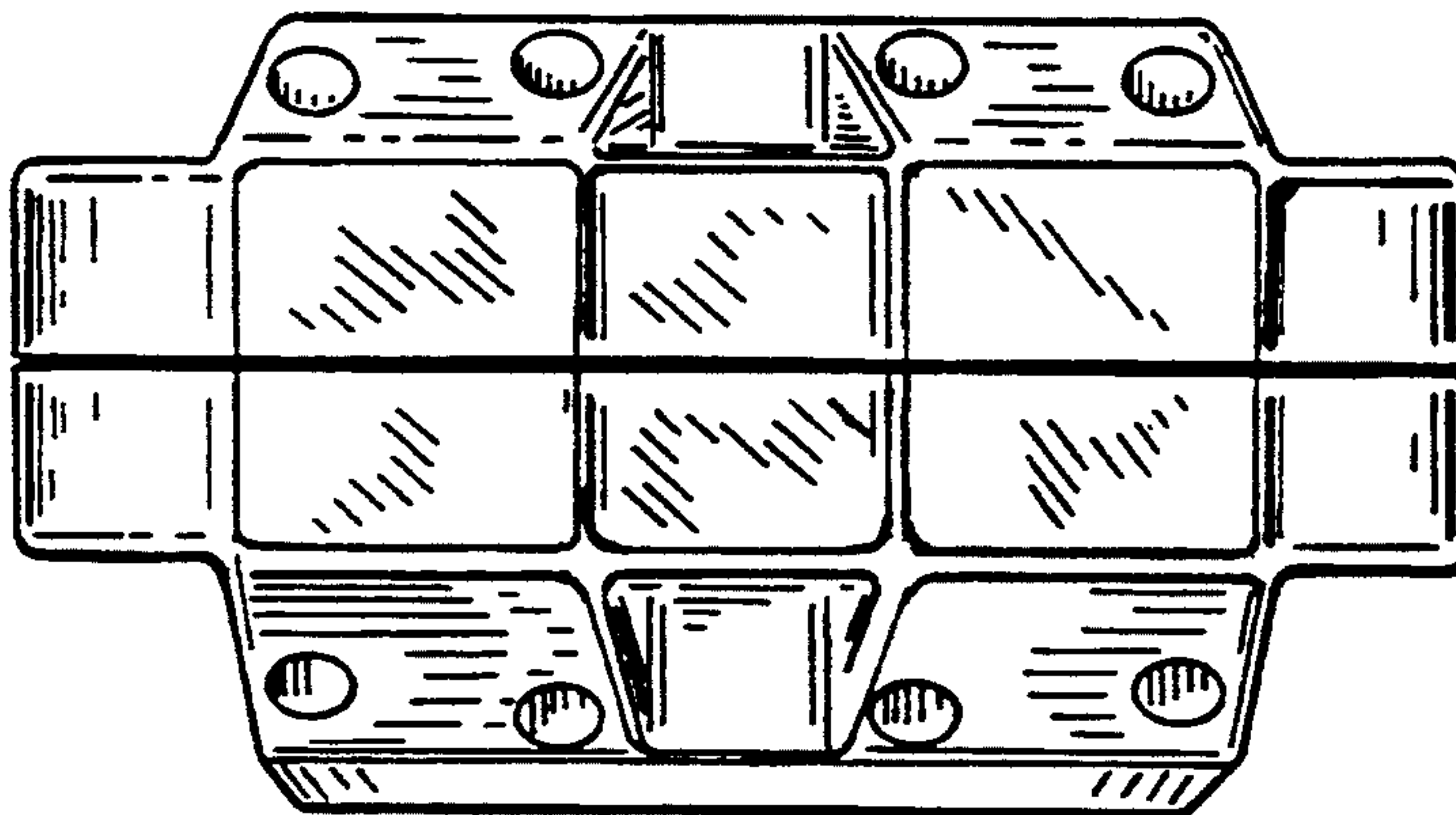

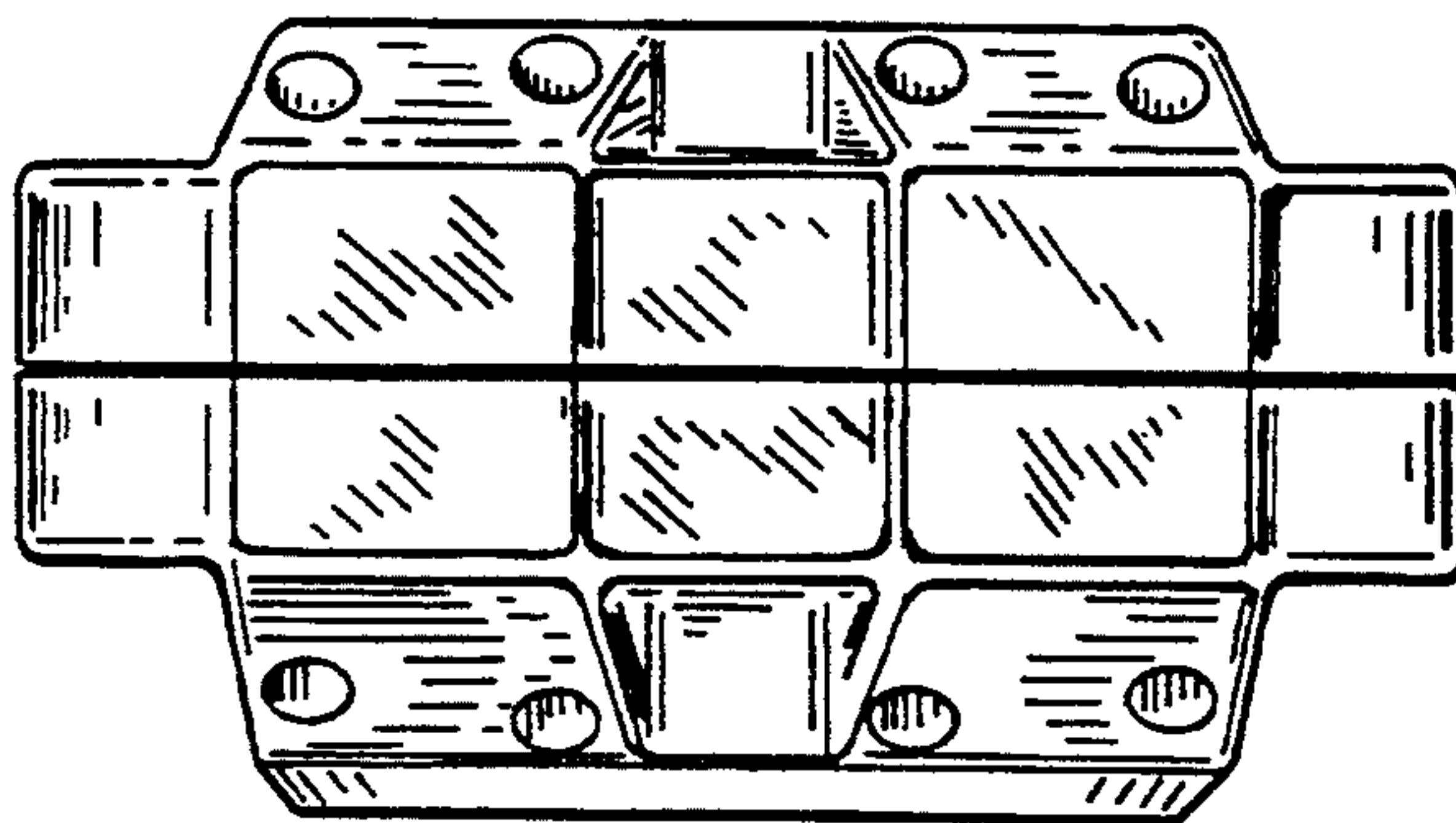

FIG. 1

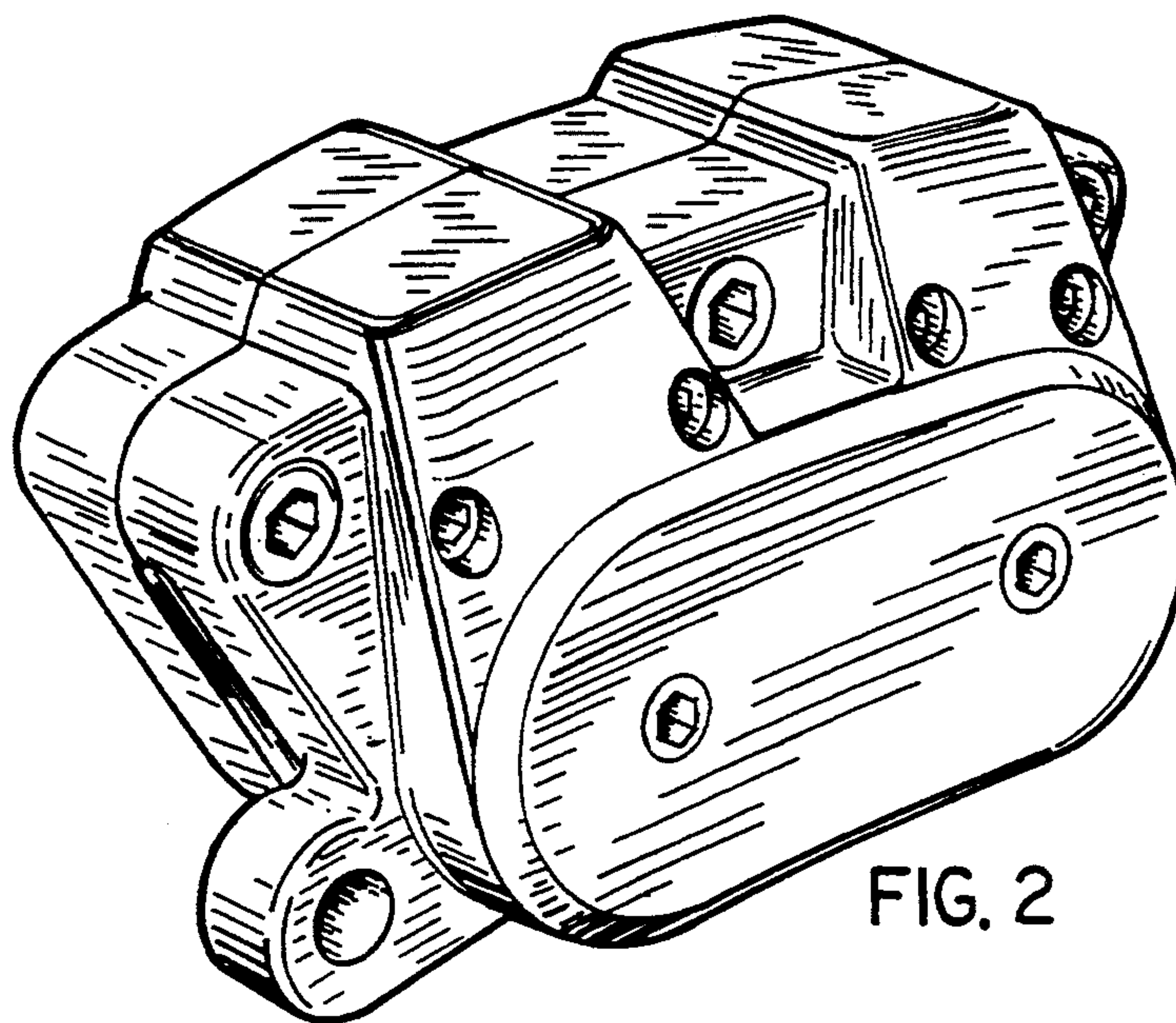

FIG. 2

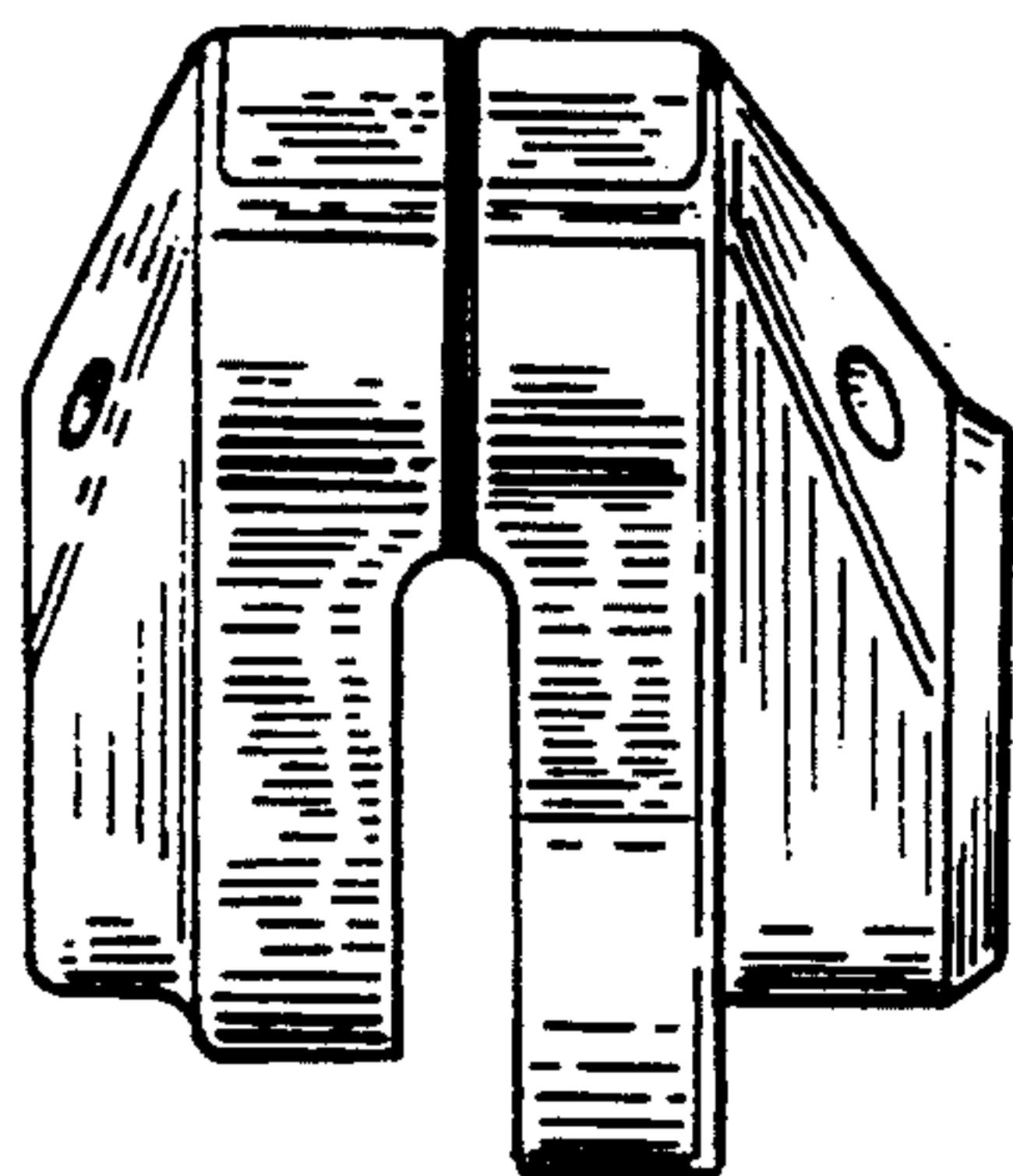

FIG. 3

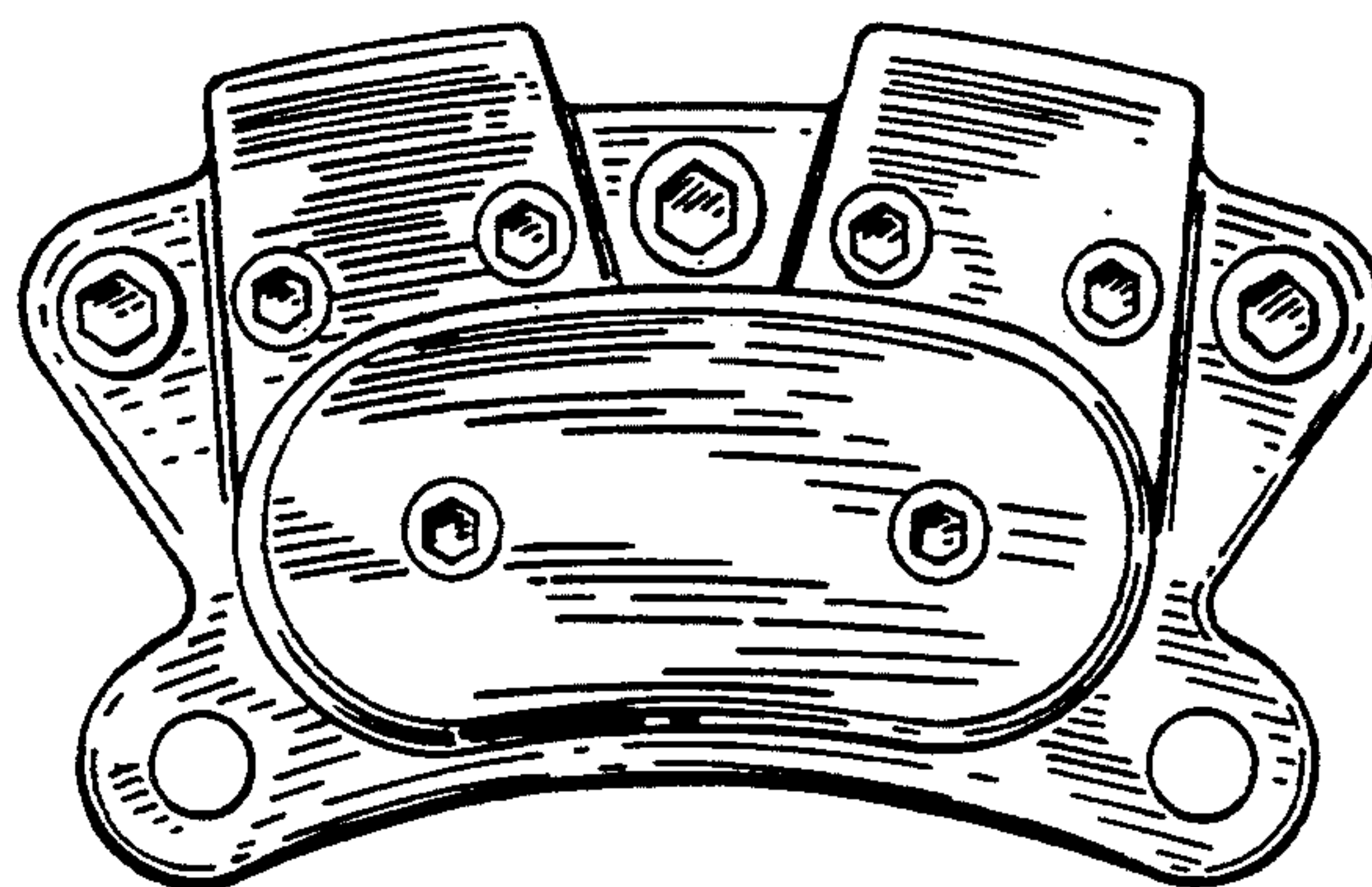

FIG. 4

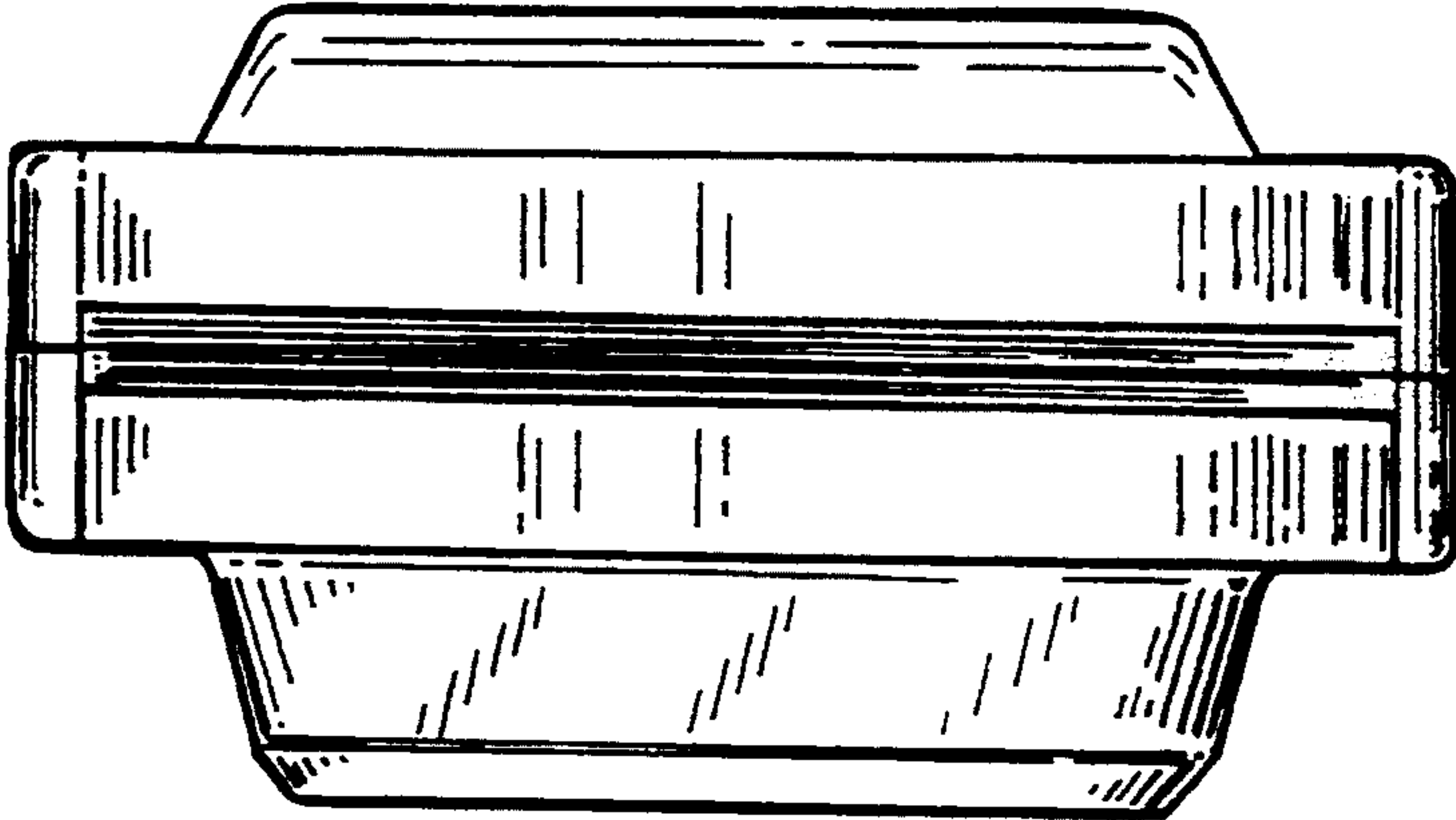

FIG. 5

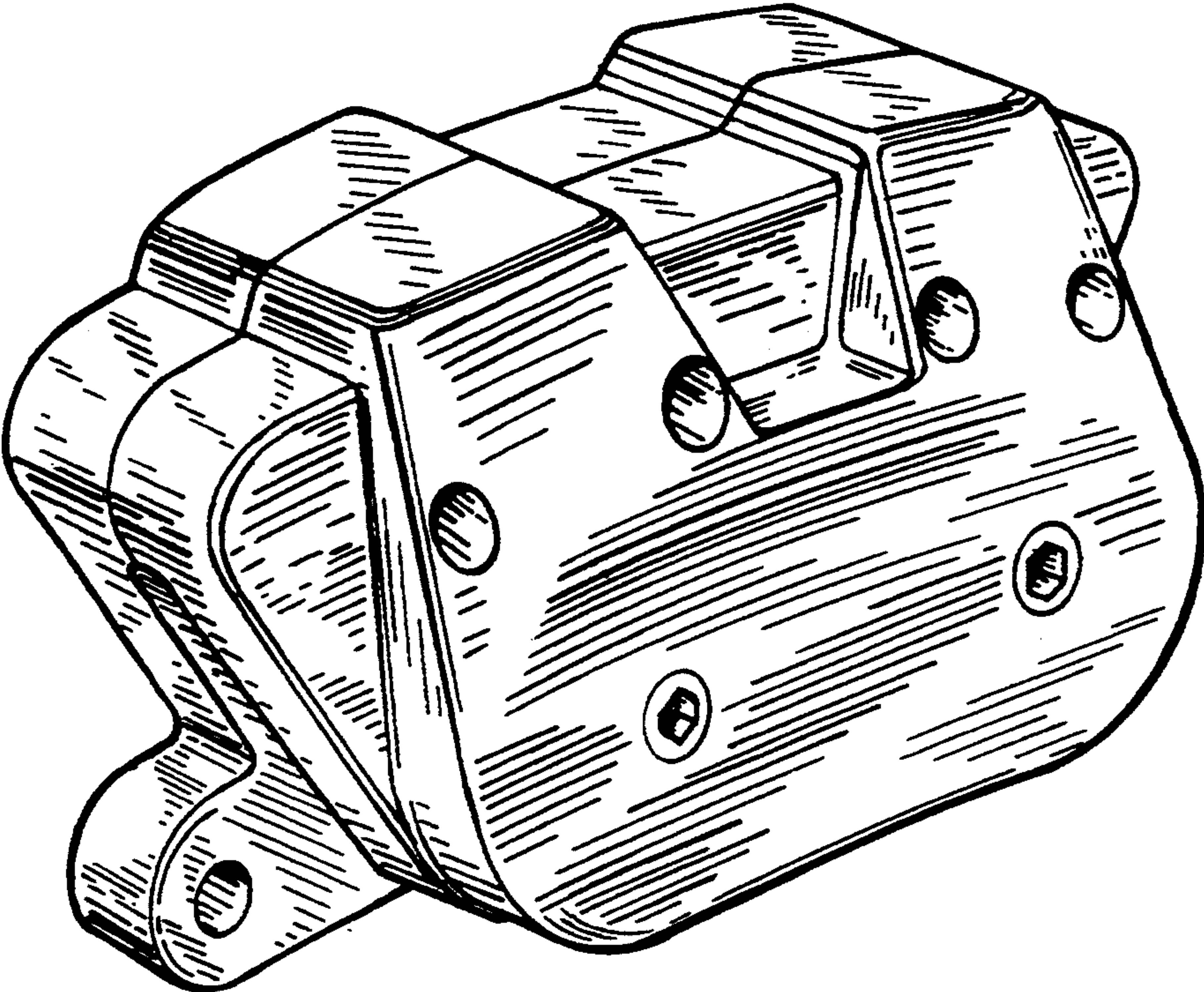

FIG. 6