



US00D354456S

United States Patent [19]

[11] Patent Number: Des. 354,456

St. Clair

[45] Date of Patent: ** Jan. 17, 1995

[54] QUICK RELEASE STRAP

DESCRIPTION

[76] Inventor: **Chris St. Clair**, 1341 F N. McDowell Blvd., Petaluma, Calif. 94954

FIG. 1 is a perspective view of the quick release strap showing my new design;

[**] Term: **14 Years**

FIG. 2 is an unbuckled exploded perspective view thereof;

[21] Appl. No.: **15,016**

FIG. 3 is a top plan view thereof, the bottom view being identical;

[22] Filed: **Nov. 5, 1993**

FIG. 4 is a left side elevational view thereof, the right side being a mirror image;

[52] U.S. Cl. **D11/215**

FIG. 5 is a front elevational view thereof;

[58] Field of Search D11/200, 201, 215-220; 24/307, 616, 609, 660, 633, 200, 196, 171, 169, 625, 68 A, 579; 2/DIG. 6

FIG. 6 is a rear elevational view thereof;

FIG. 7 is a top plan view of the female component, the bottom view being identical;

[56] References Cited

U.S. PATENT DOCUMENTS

D. 252,956	9/1979	Frost	D11/200
D. 300,614	4/1989	Geldwerth	D11/216
5,084,946	2/1992	Lee	24/625
5,144,725	9/1992	Krauss	24/625
5,148,582	9/1992	Dennis, Jr.	24/625

FIG. 8 is a left side view of the female component, the right side being a mirror image thereof;

FIG. 9 is a front elevational view of the female component;

FIG. 10 is a rear elevational view of the female component;

FIG. 11 is a top plan view of the male component, the bottom view being identical;

Primary Examiner—Ralf T. Seifert

Attorney, Agent, or Firm—Larry D. Johnson

FIG. 12 is a right side view of the male component, the left side being a mirror image thereof;

FIG. 13 is a front elevational view of the male component; and,

FIG. 14 is a rear elevational view of the male component.

[57] CLAIM

The ornamental design for a quick release strap, as shown and described.

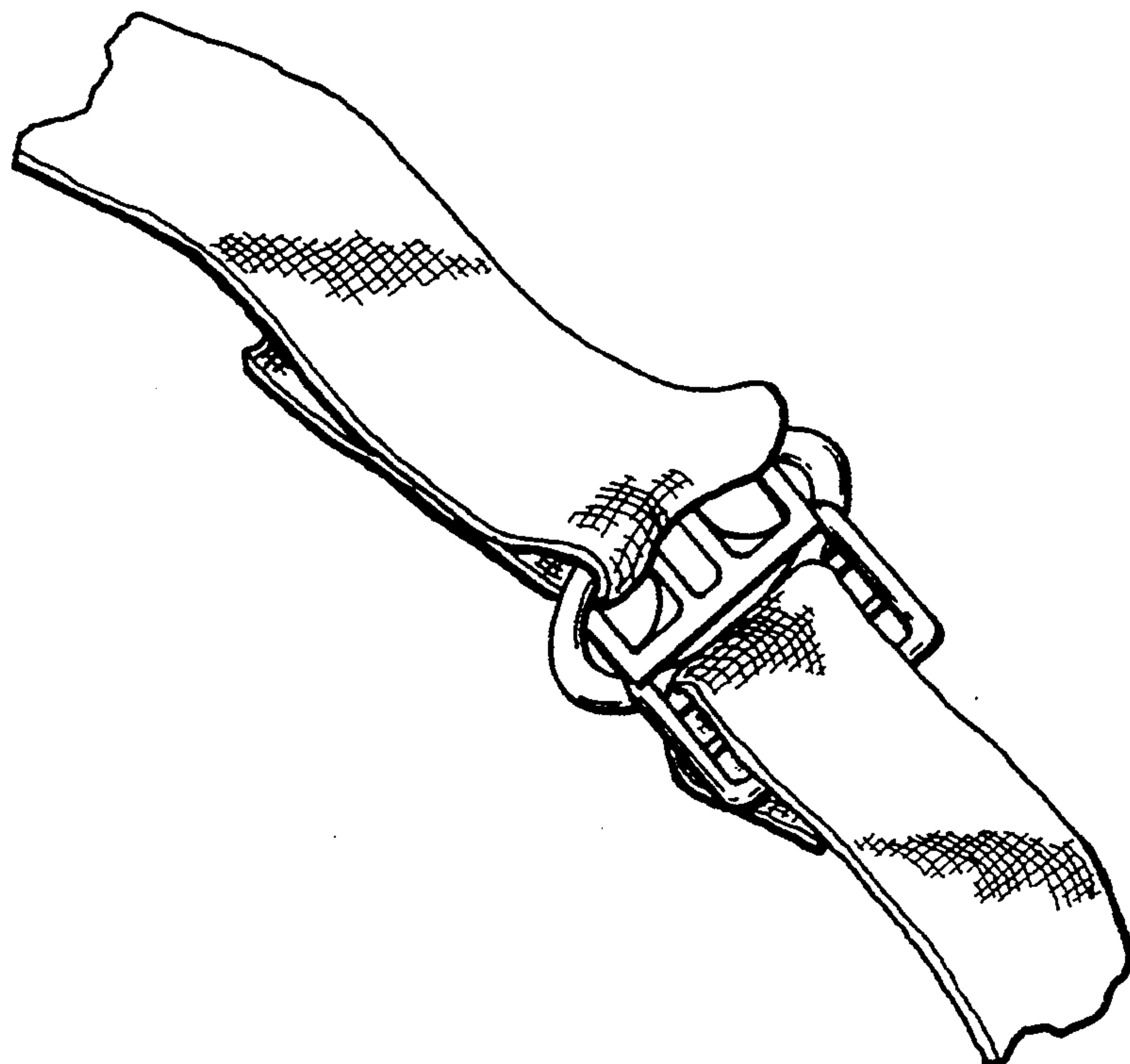

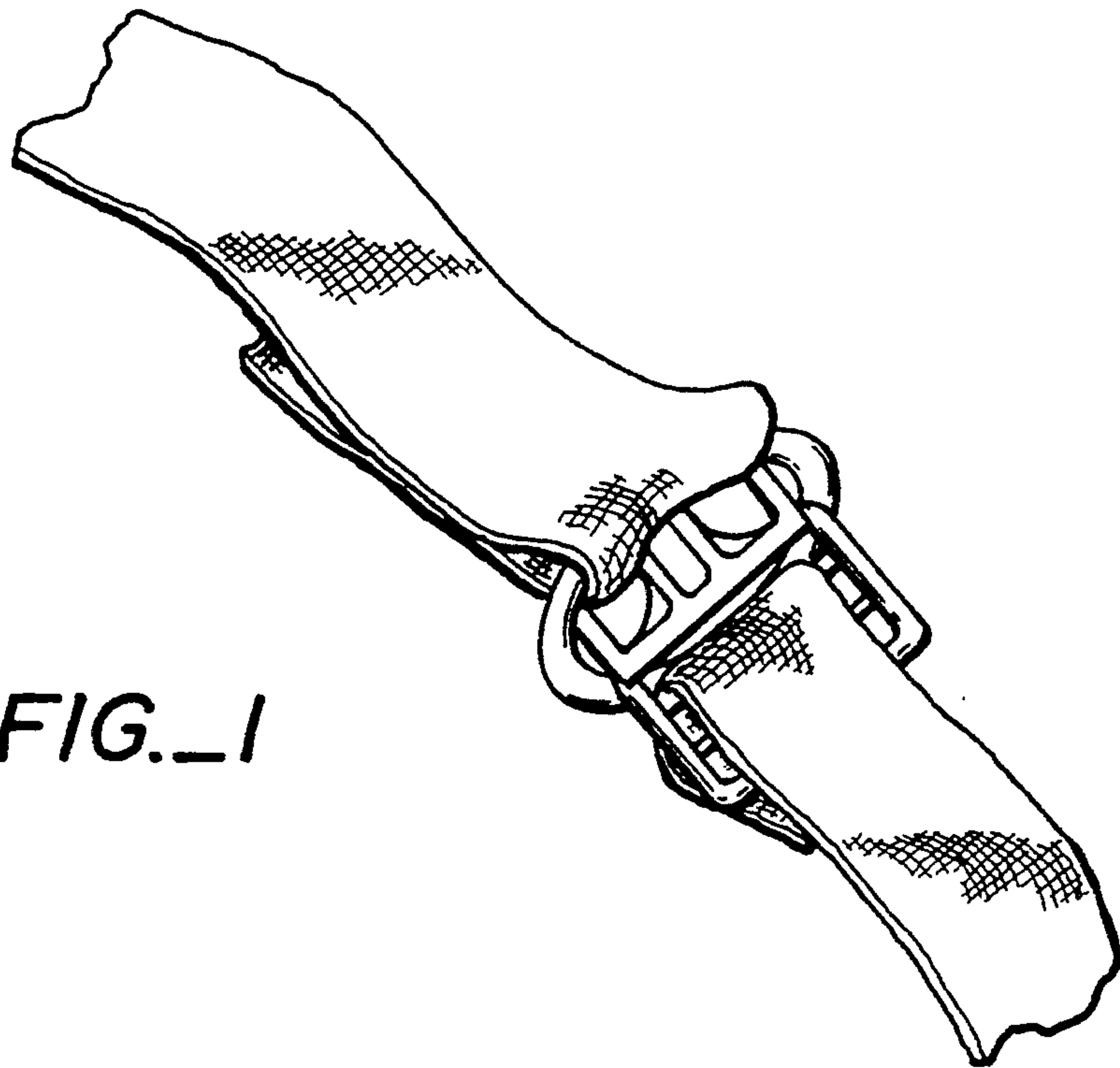

FIG. 1

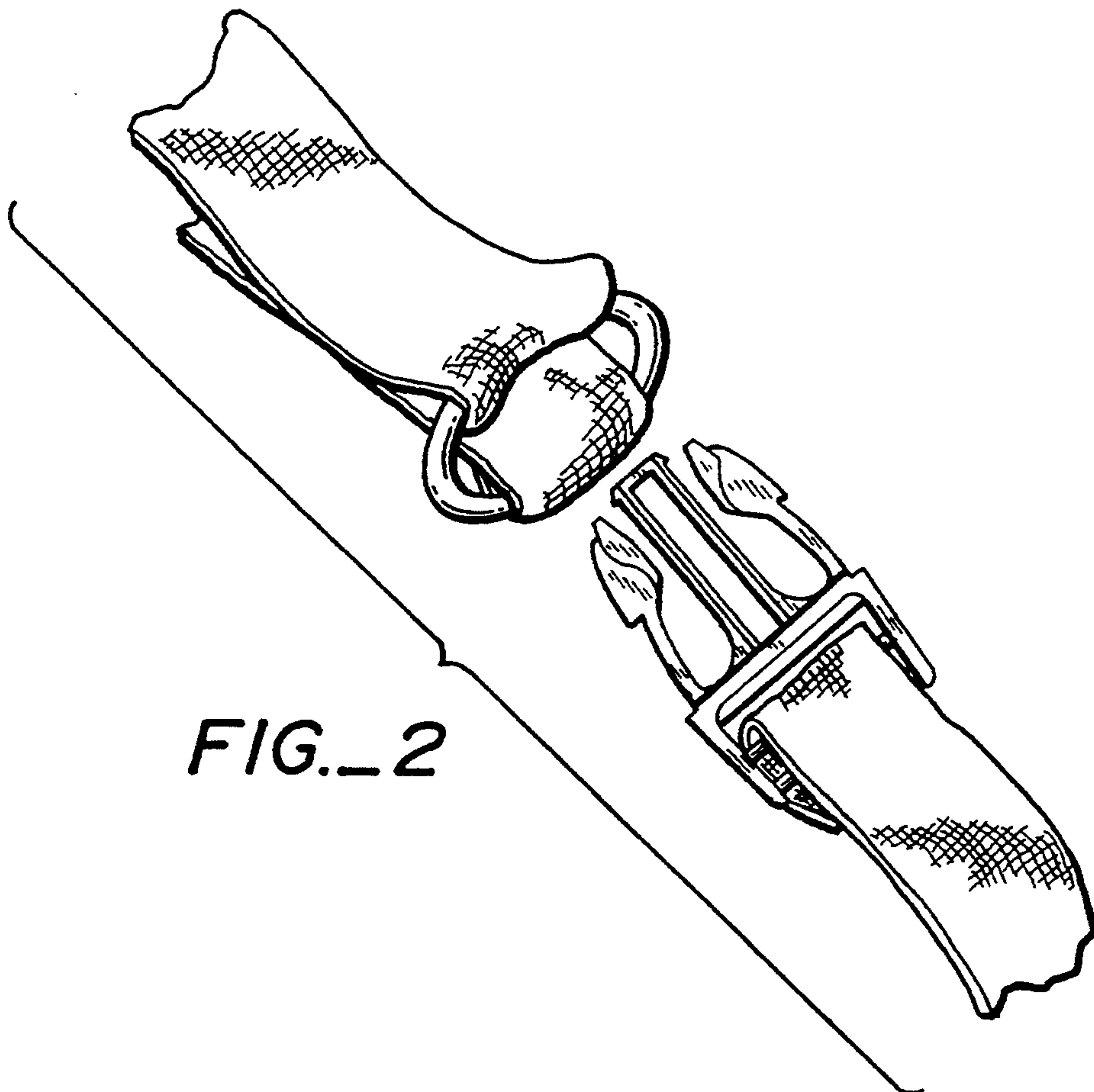

FIG. 2

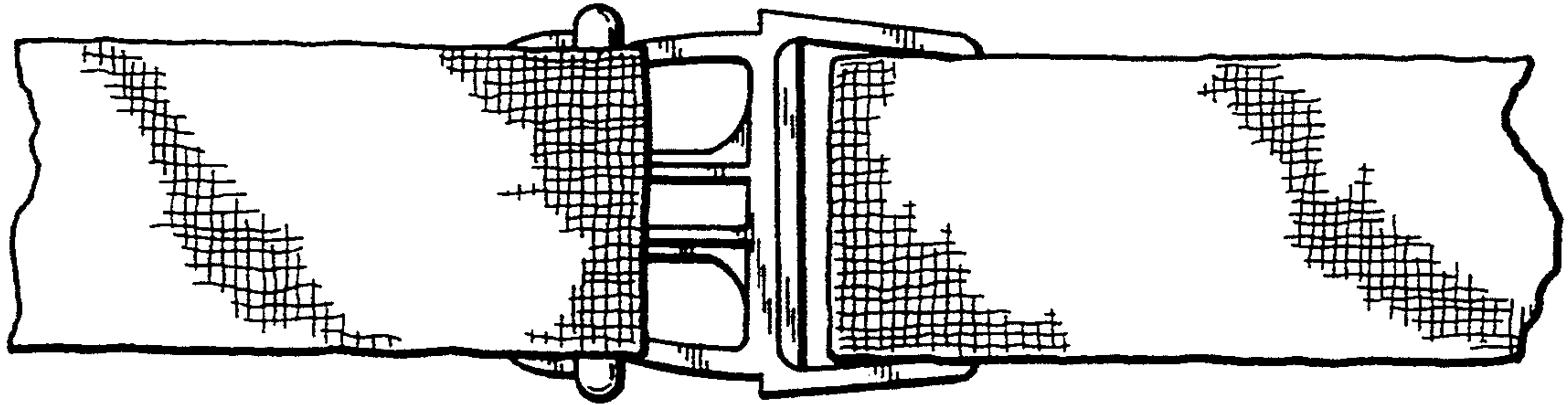

FIG._3

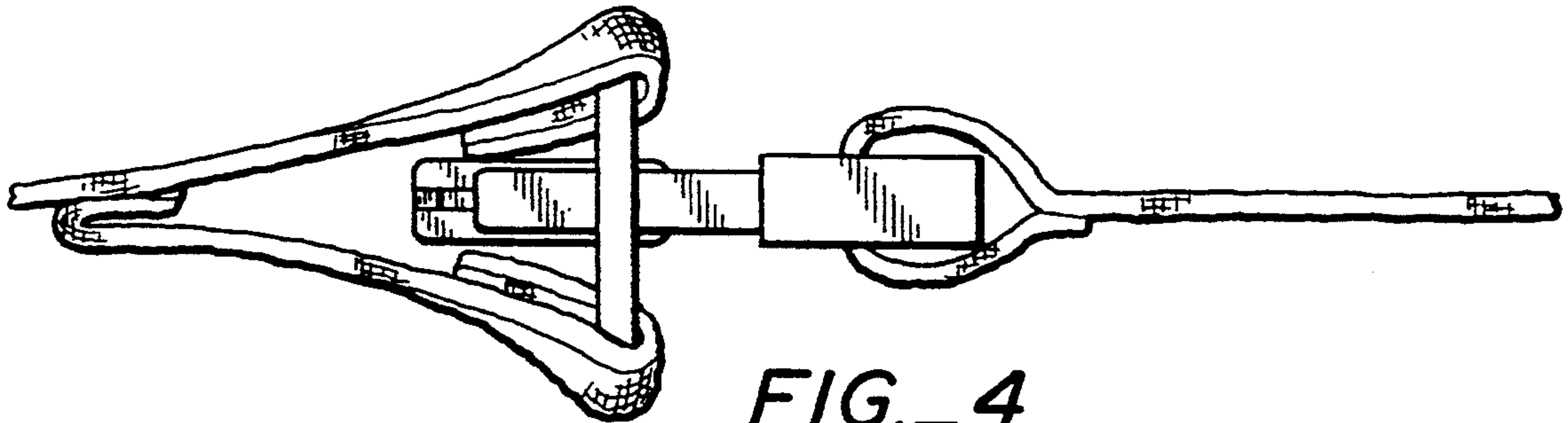

FIG._4

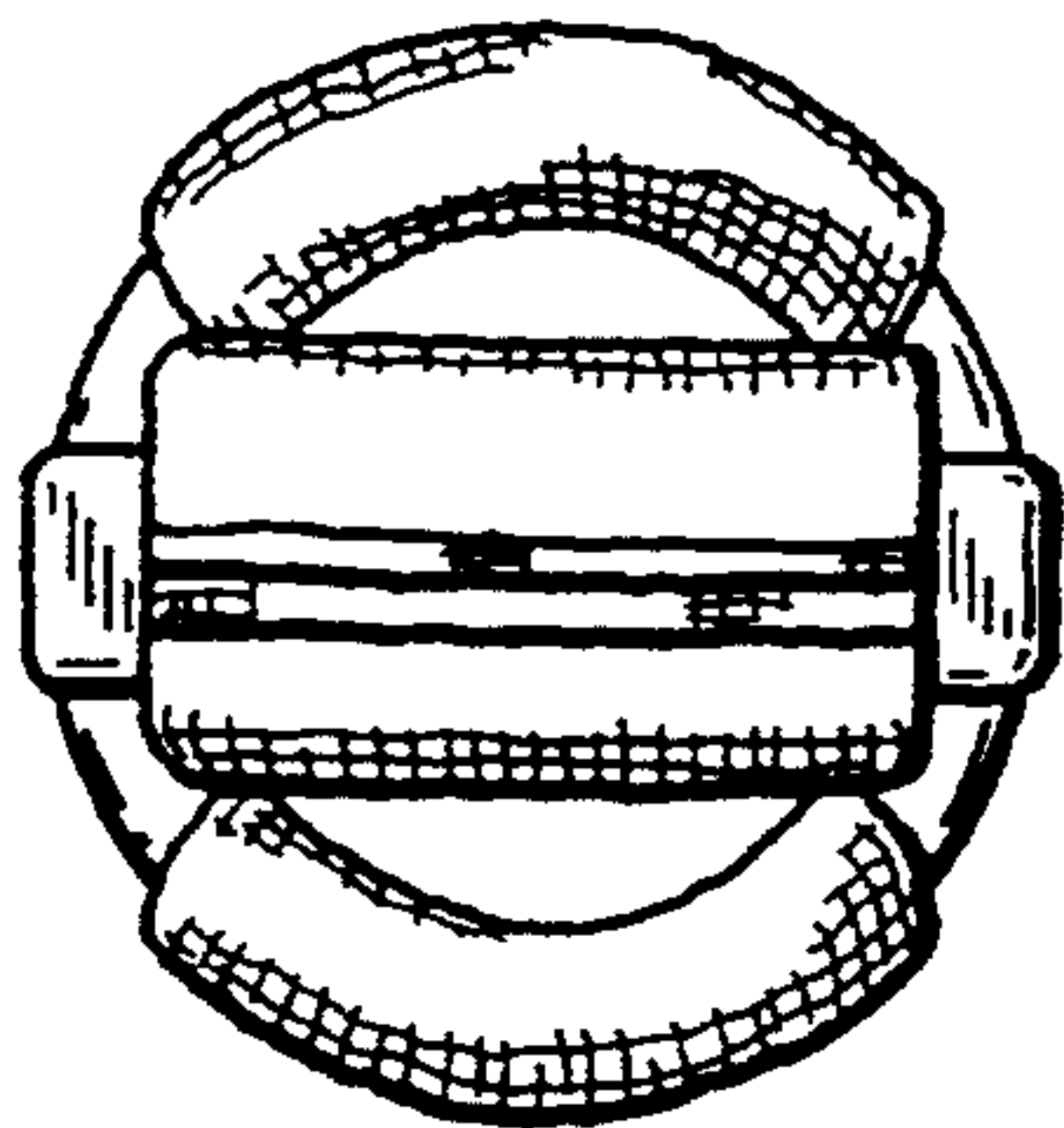

FIG._5

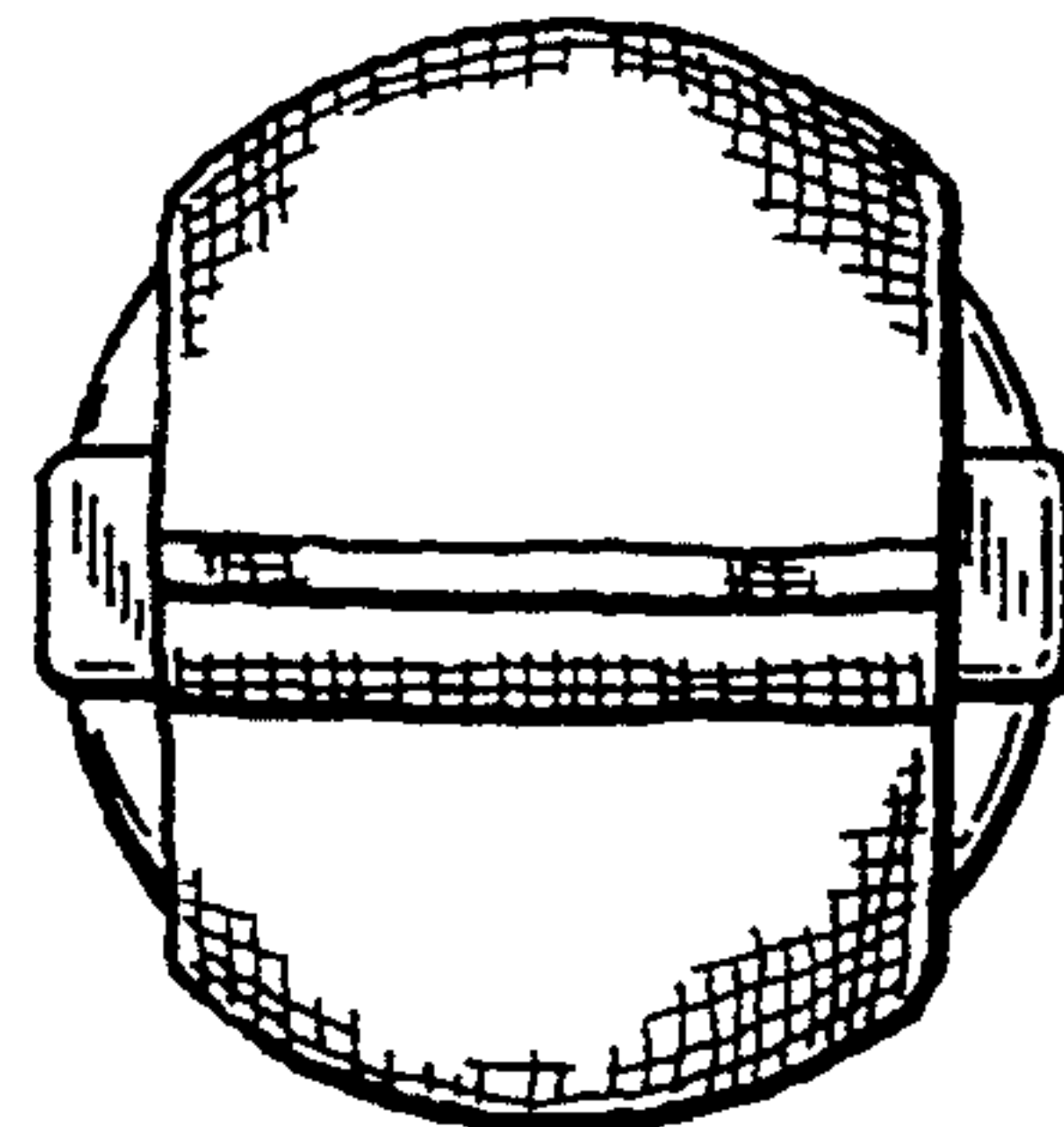

FIG._6

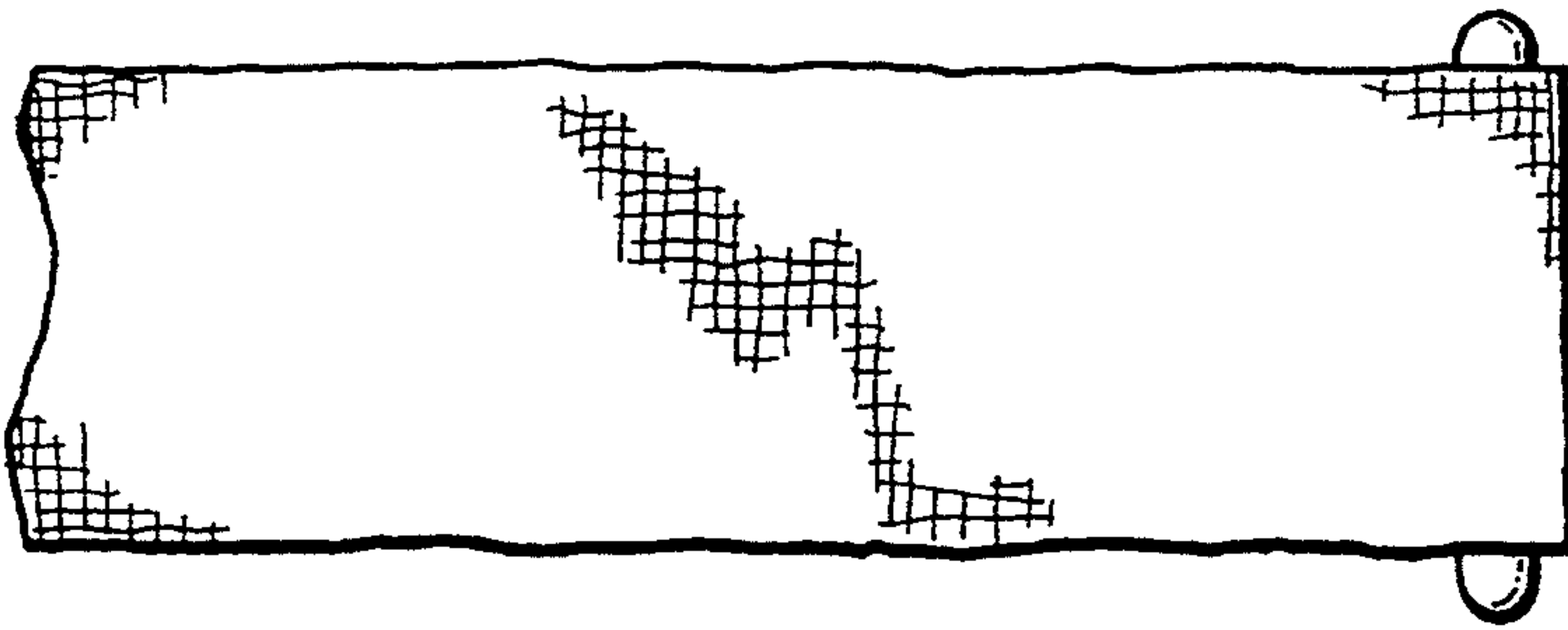

FIG._7

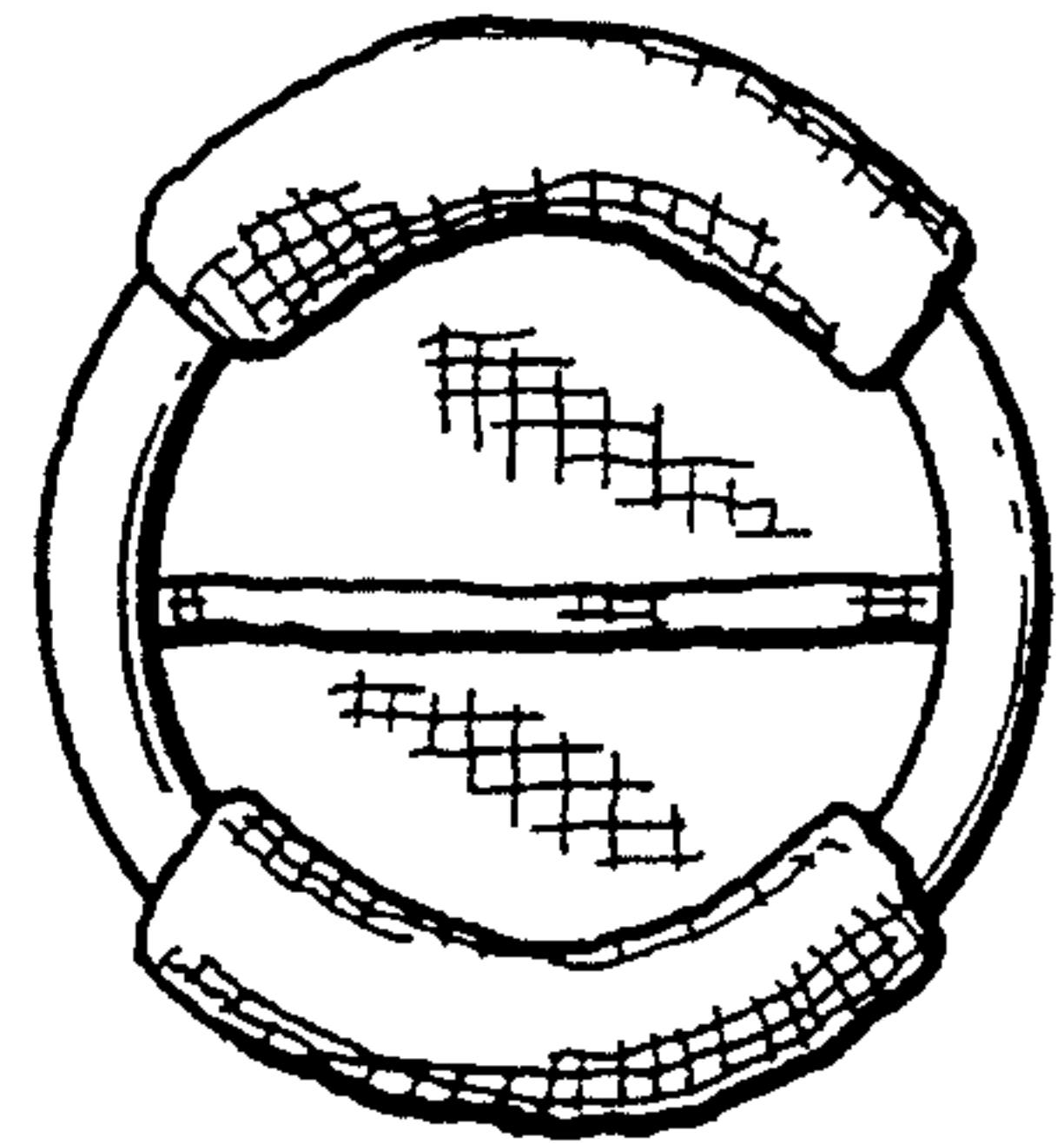

FIG._9

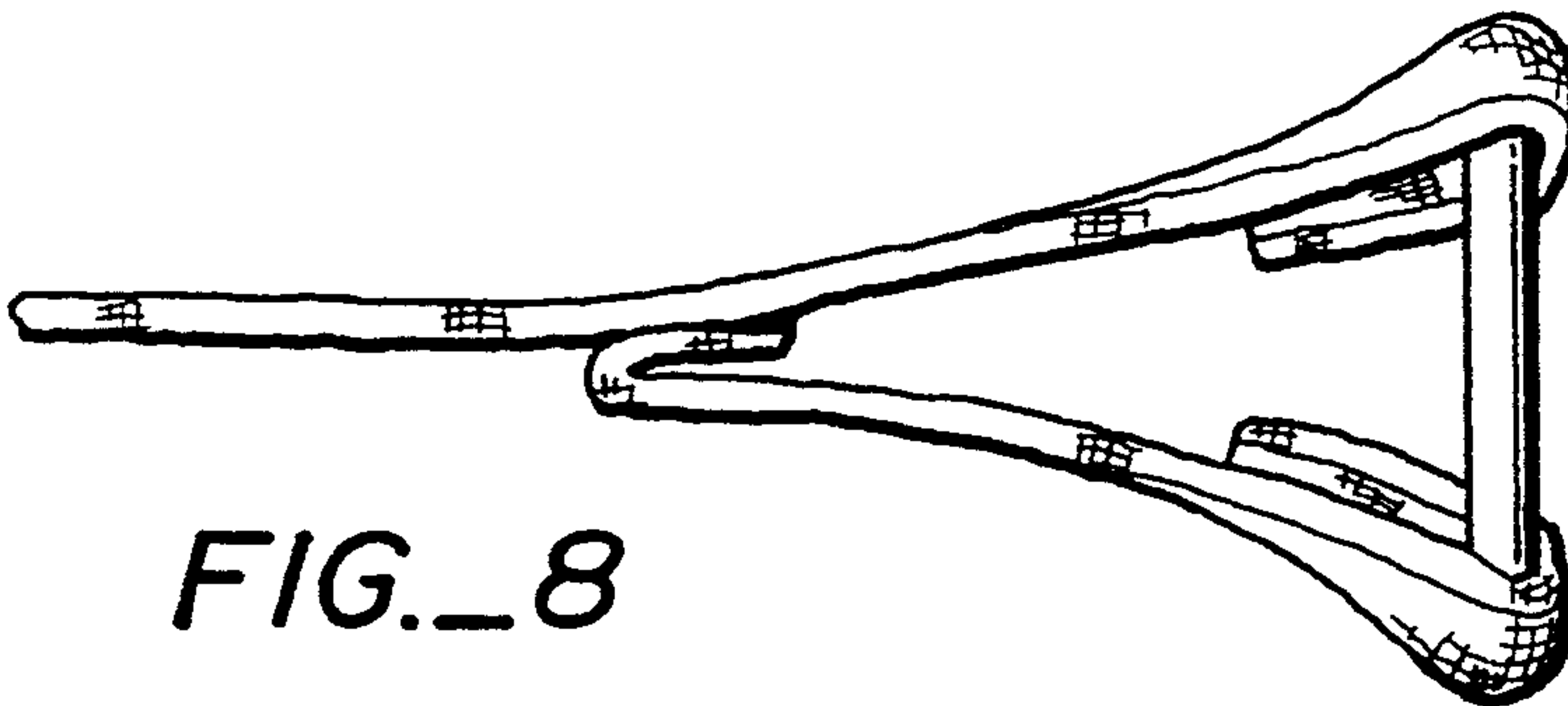

FIG._8

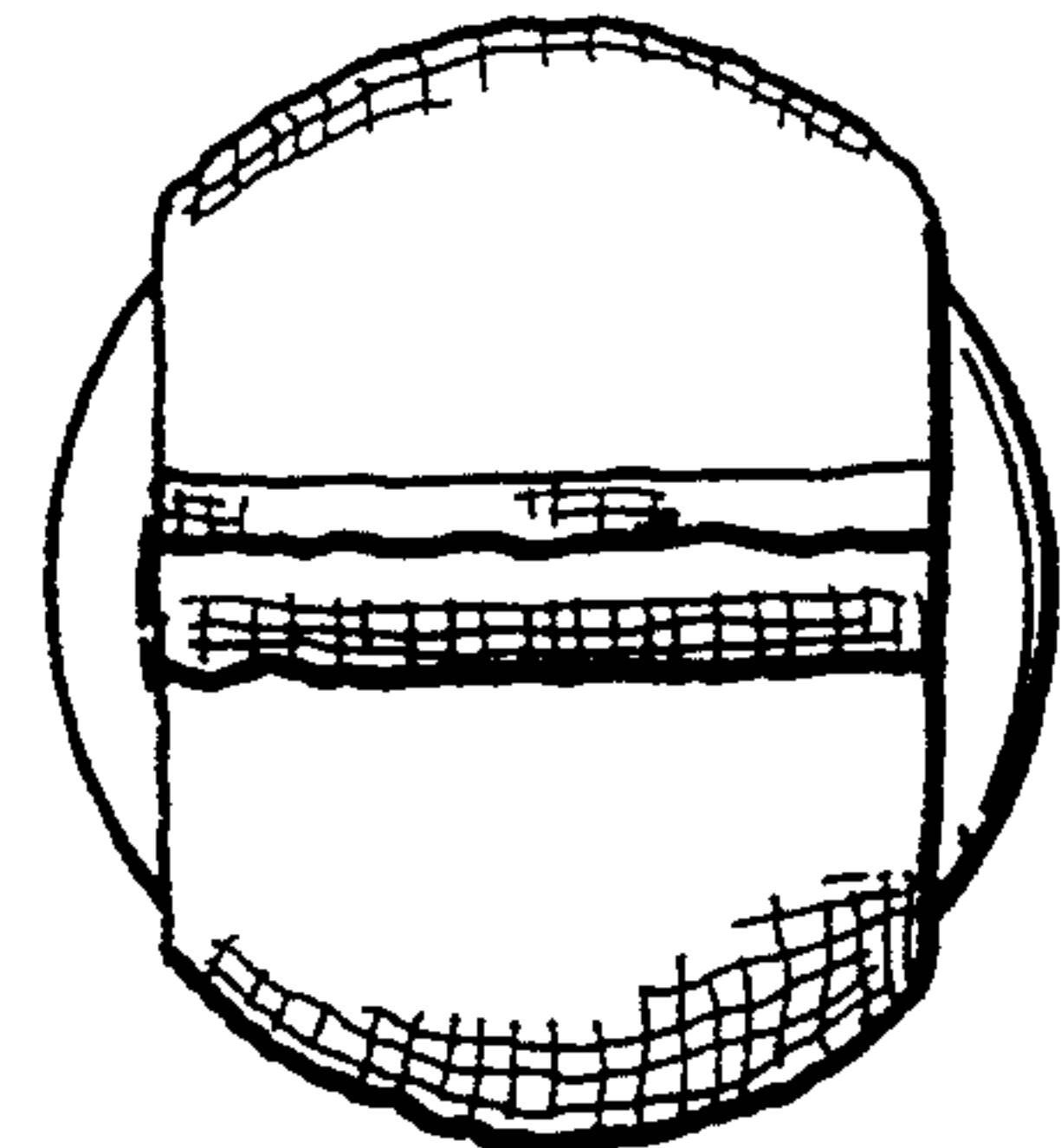

FIG._10

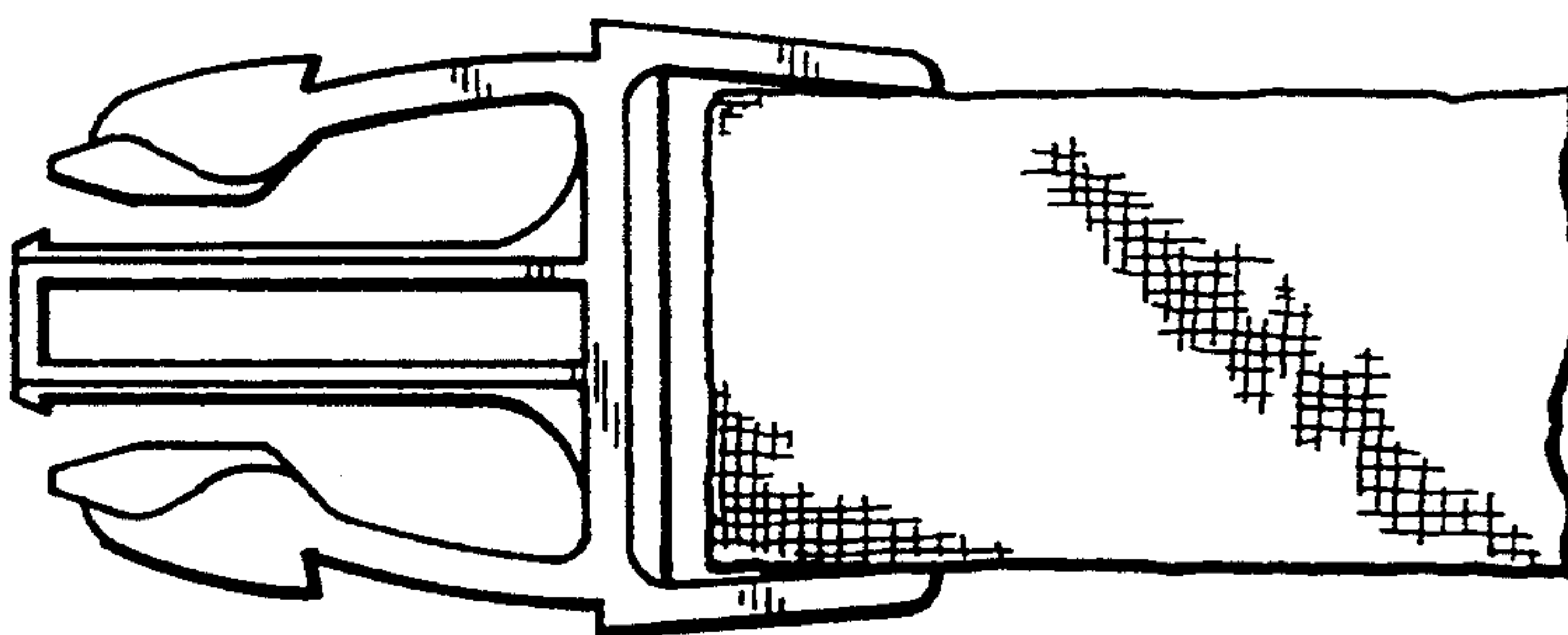

FIG._11

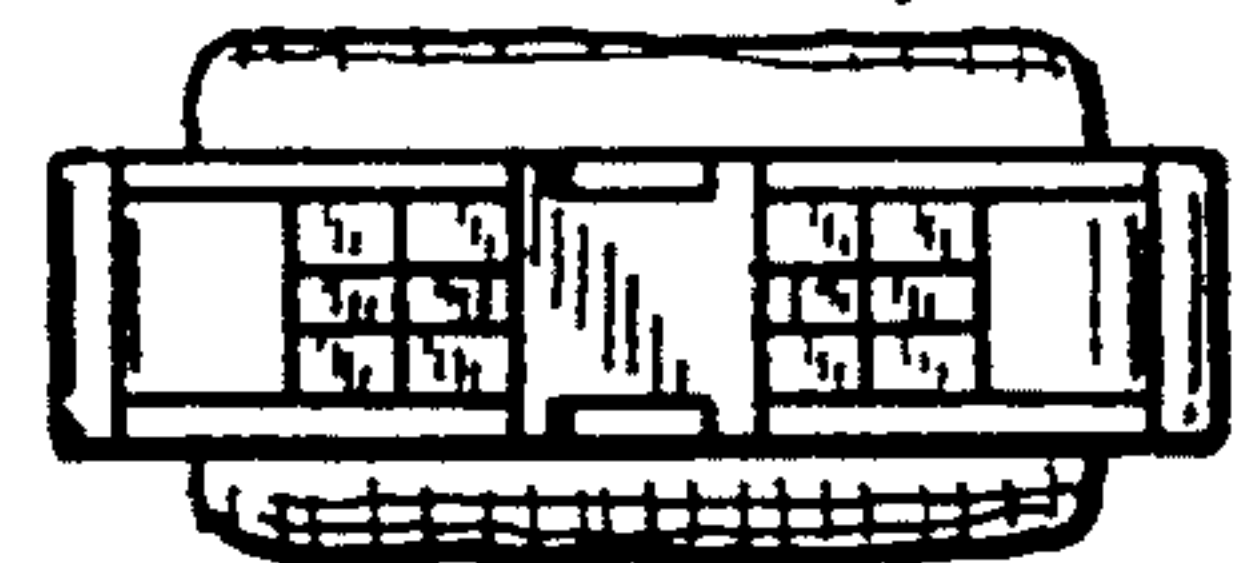

FIG._13

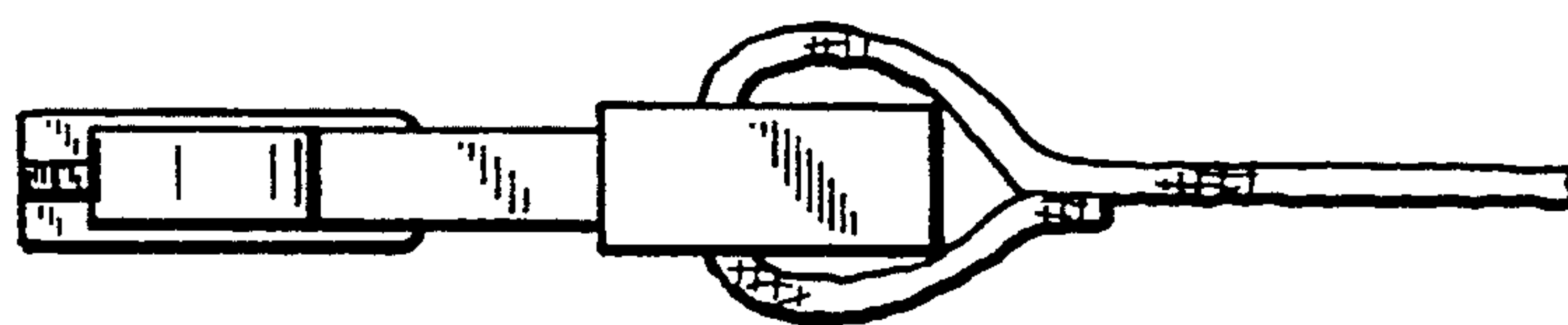

FIG._12

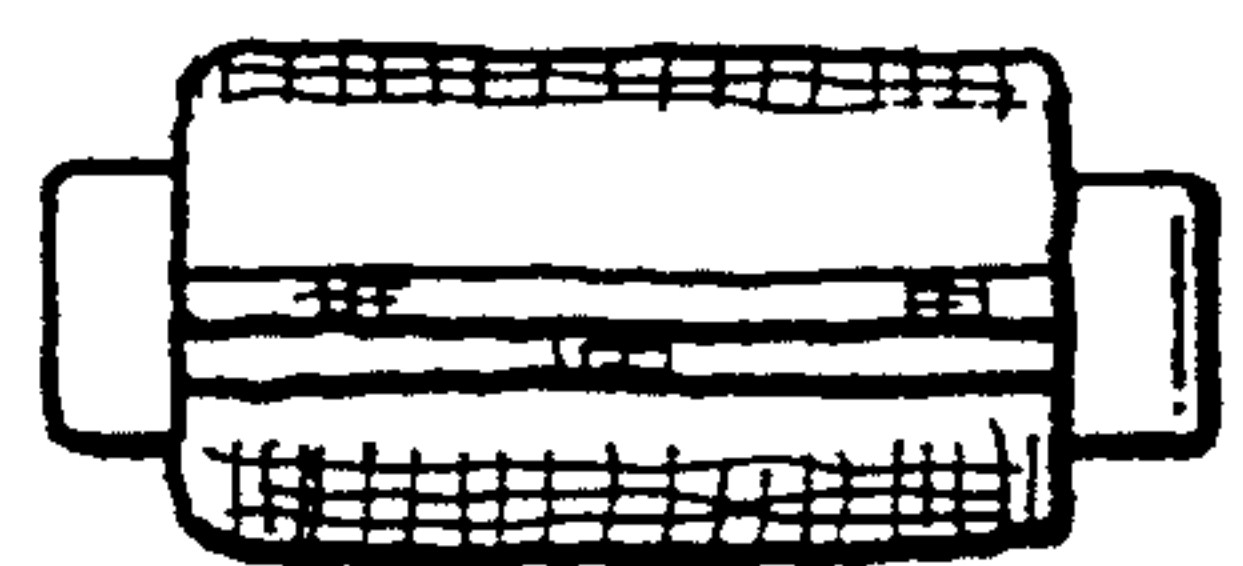

FIG._14