



US00D354314S

United States Patent [19]
Steininger

[11] **Patent Number: Des. 354,314**
[45] **Date of Patent: ** Jan. 10, 1995**

[54] **DART BOWLING GAME**
[76] **Inventor: George A. Steininger, 474 W. Oakwood Ave., Orange City, Fla. 32763**
[**] **Term: 14 Years**
[21] **Appl. No.: 3,746**
[22] **Filed: Jan. 19, 1993**
[52] **U.S. Cl. D21/6**
[58] **Field of Search D21/5, 6, 14-36; 273/236-286, 347, 348, 408**

D. 296,708 7/1988 Garrett D21/6

OTHER PUBLICATIONS

Playthings Sep. 1942 p. 17 Wilson Dart-Bowl.

Primary Examiner—Bernard Ansher
Assistant Examiner—Sandra Morris
Attorney, Agent, or Firm—Terry M. Gernstein

[57] **CLAIM**

The ornamental design for a dart bowling game, as shown and described.

DESCRIPTION

FIG. 1 is a front, top and side perspective view of the dart bowling game showing my new design; FIG. 2 is a front elevational view thereof; FIG. 3 is a rear elevational view thereof; FIG. 4 is a side elevational view thereof; FIG. 5 is a side elevational view thereof; FIG. 6 is a top plan view thereof; and, FIG. 7 is a bottom plan view thereof.

[56] **References Cited**
U.S. PATENT DOCUMENTS
D. 127,692 6/1941 Gatrell D21/6
D. 127,974 7/1941 Sargeant D21/6
D. 128,368 7/1941 Gatrell et al. D21/6
D. 132,997 7/1942 Pease D21/6
D. 160,850 11/1950 Francis D21/22
D. 241,665 9/1976 Reed D21/6

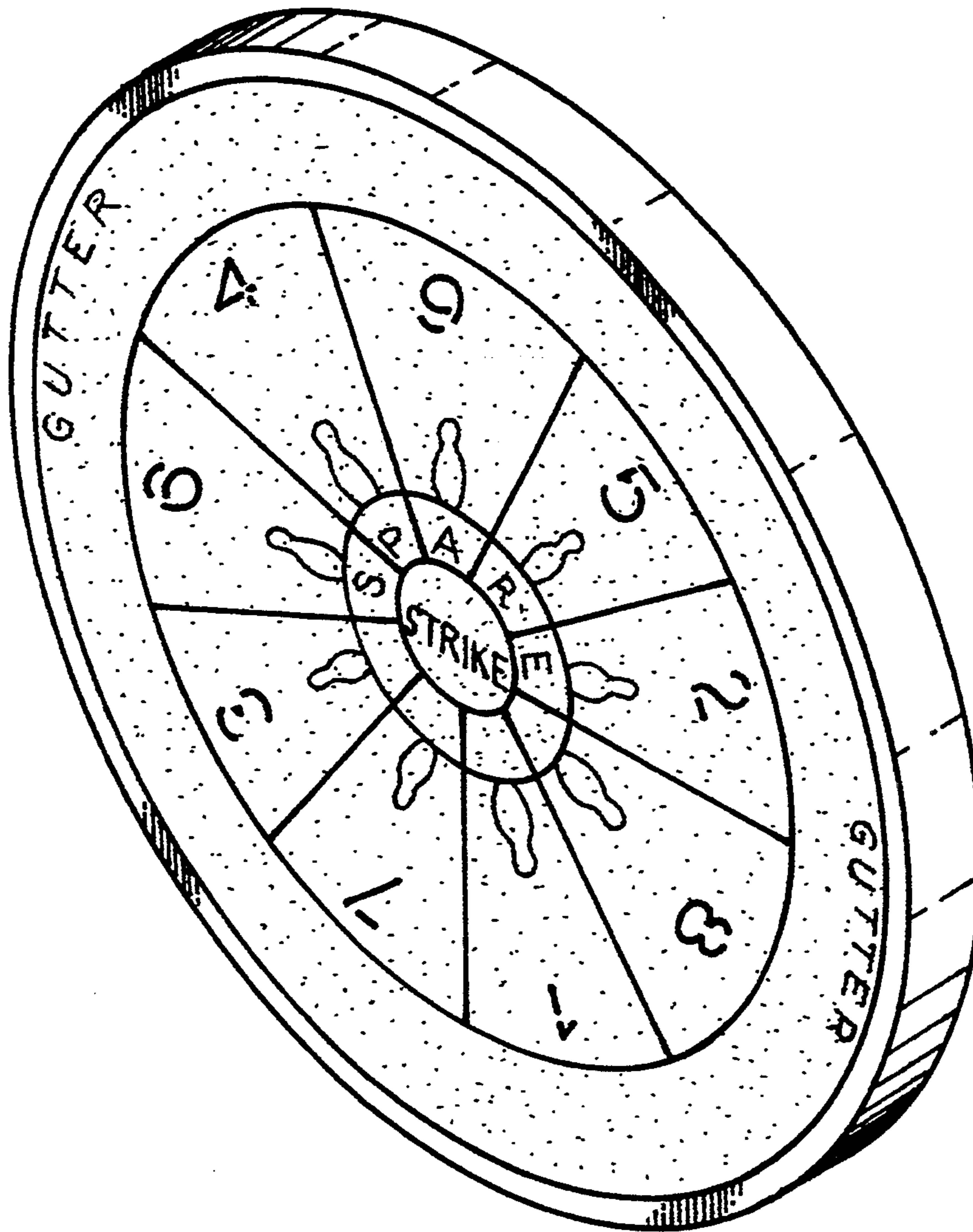

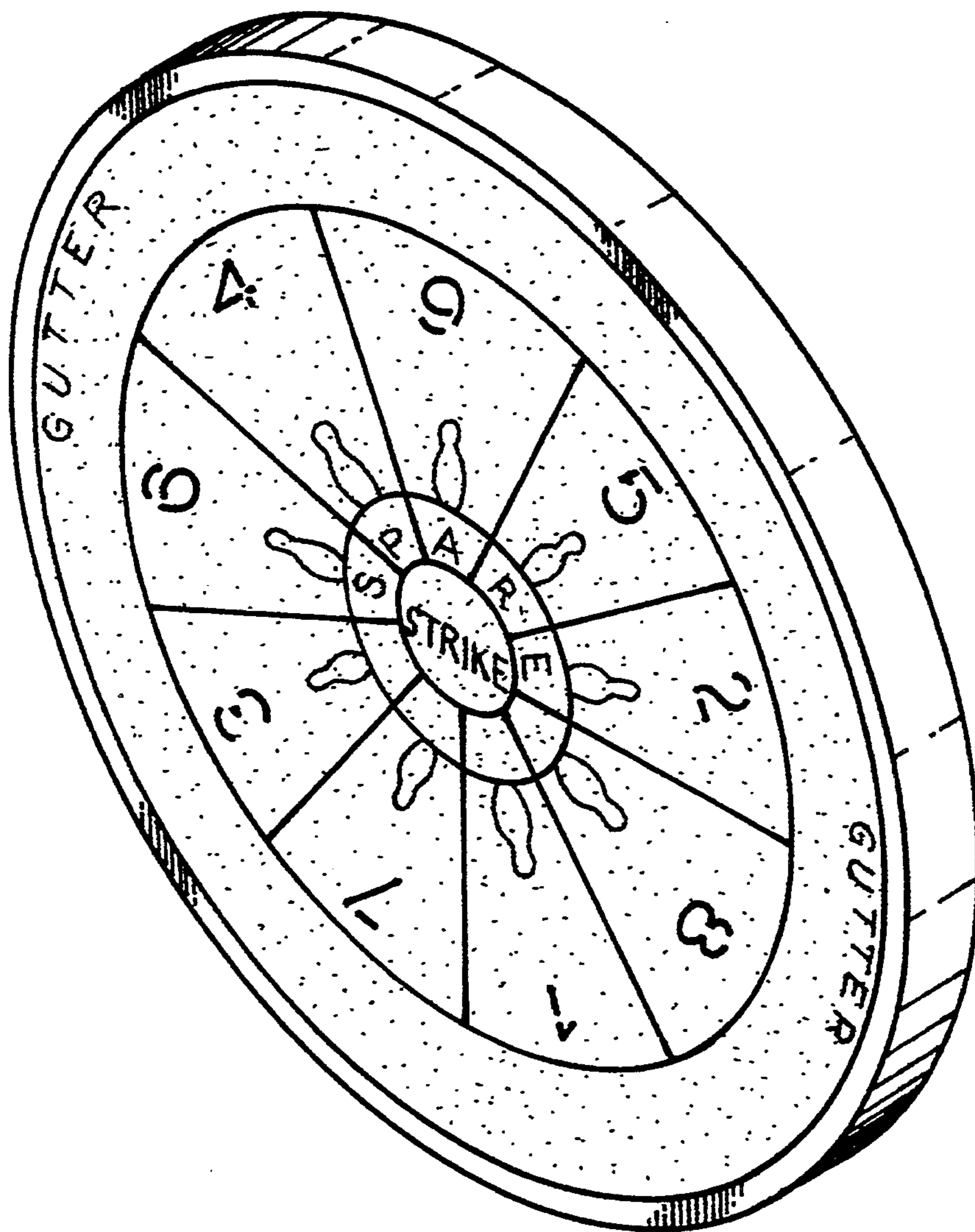

FIG. 1

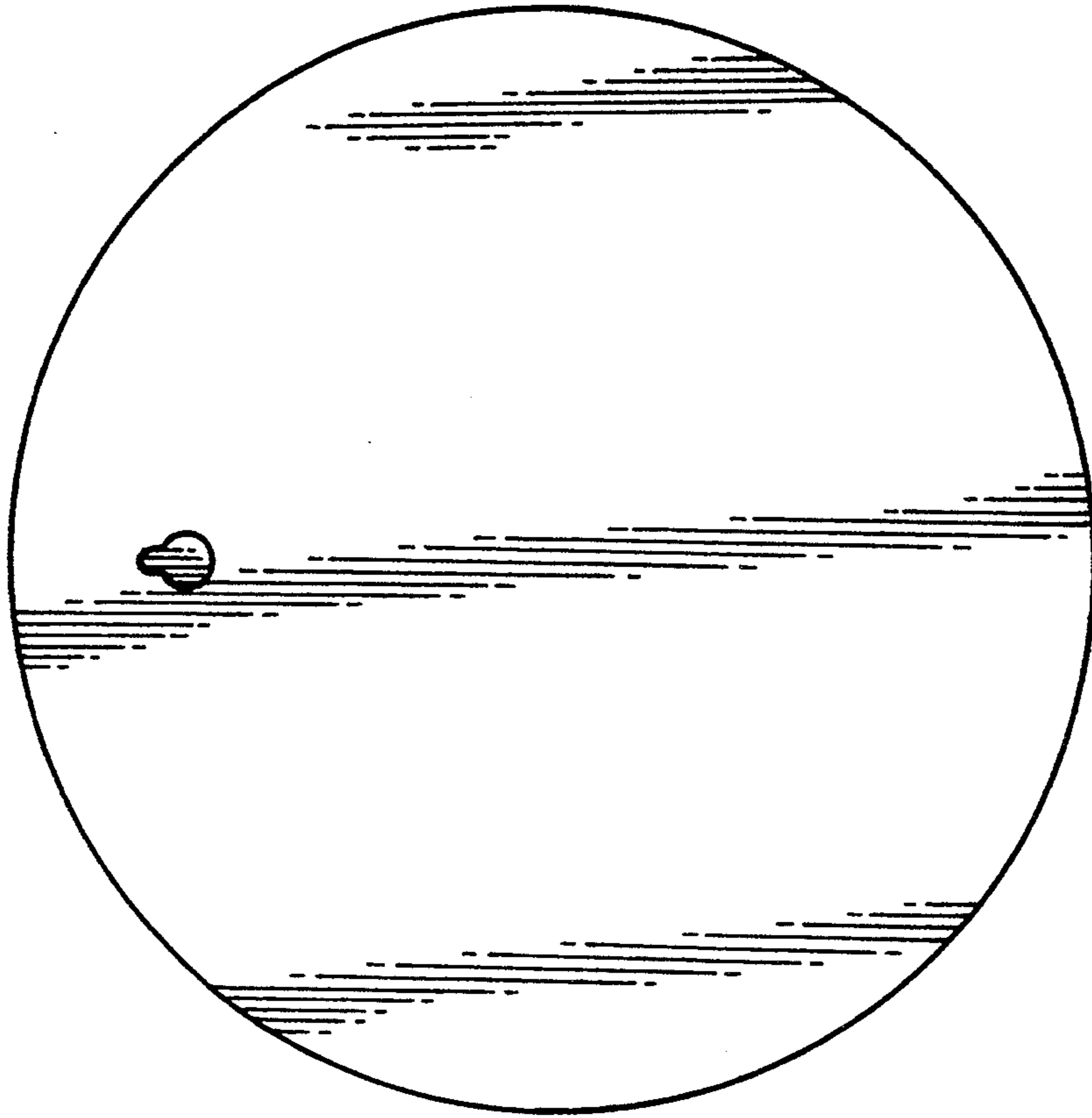

FIG. 3

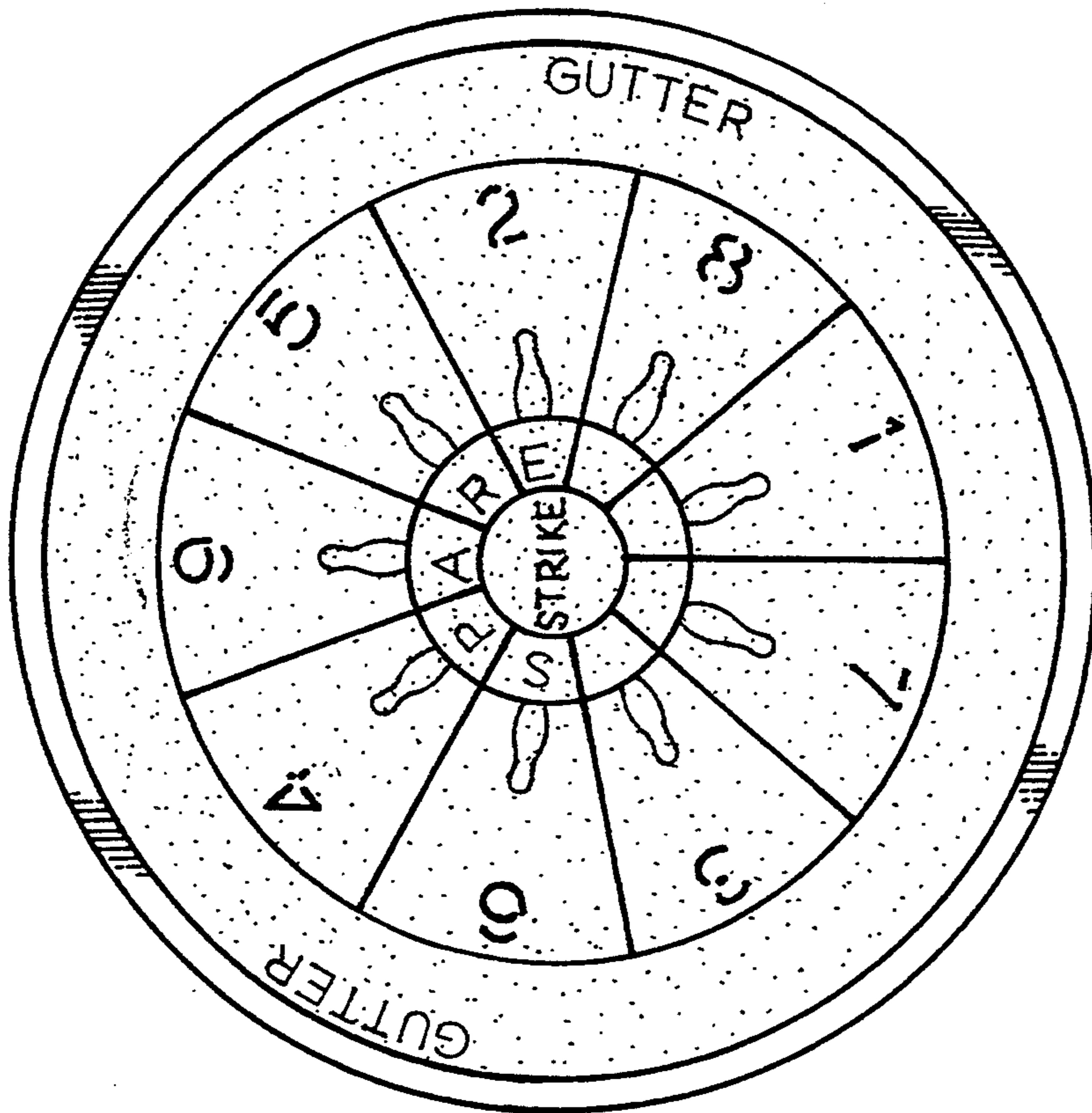

FIG. 2

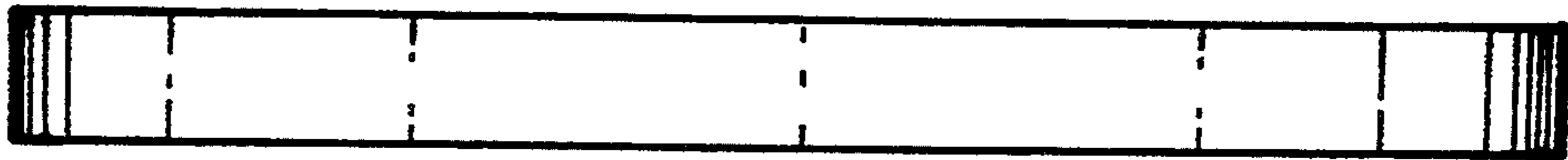
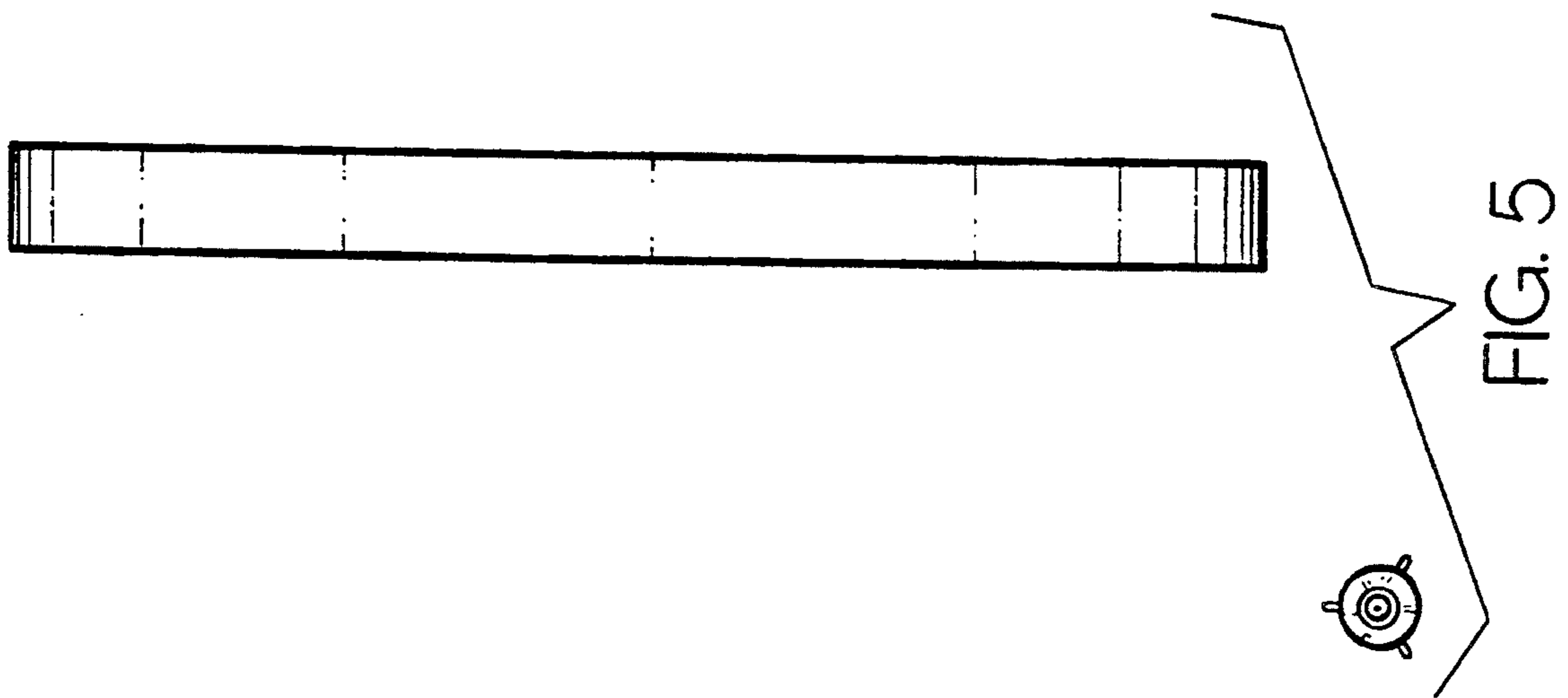

FIG. 4



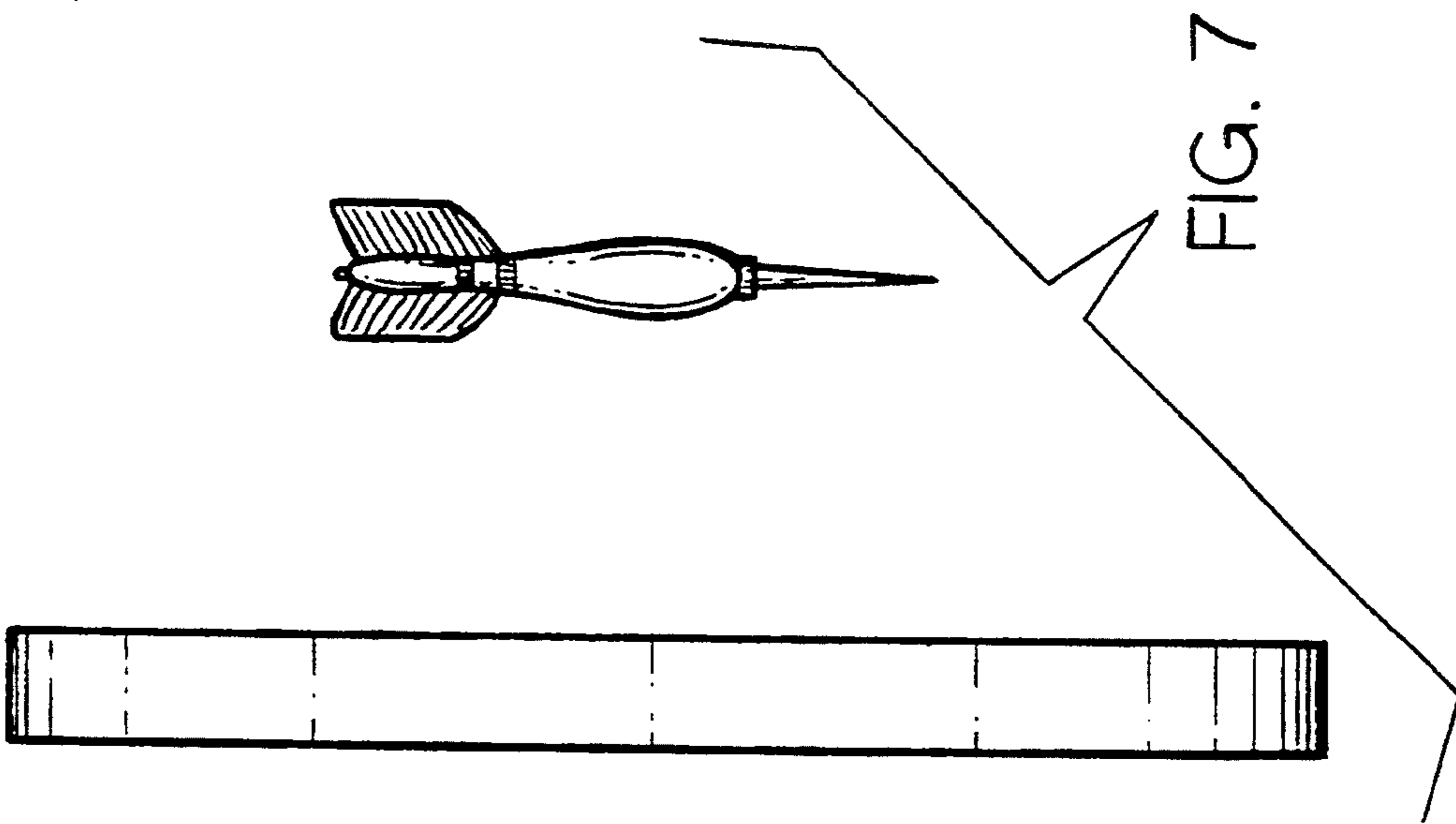

FIG. 7

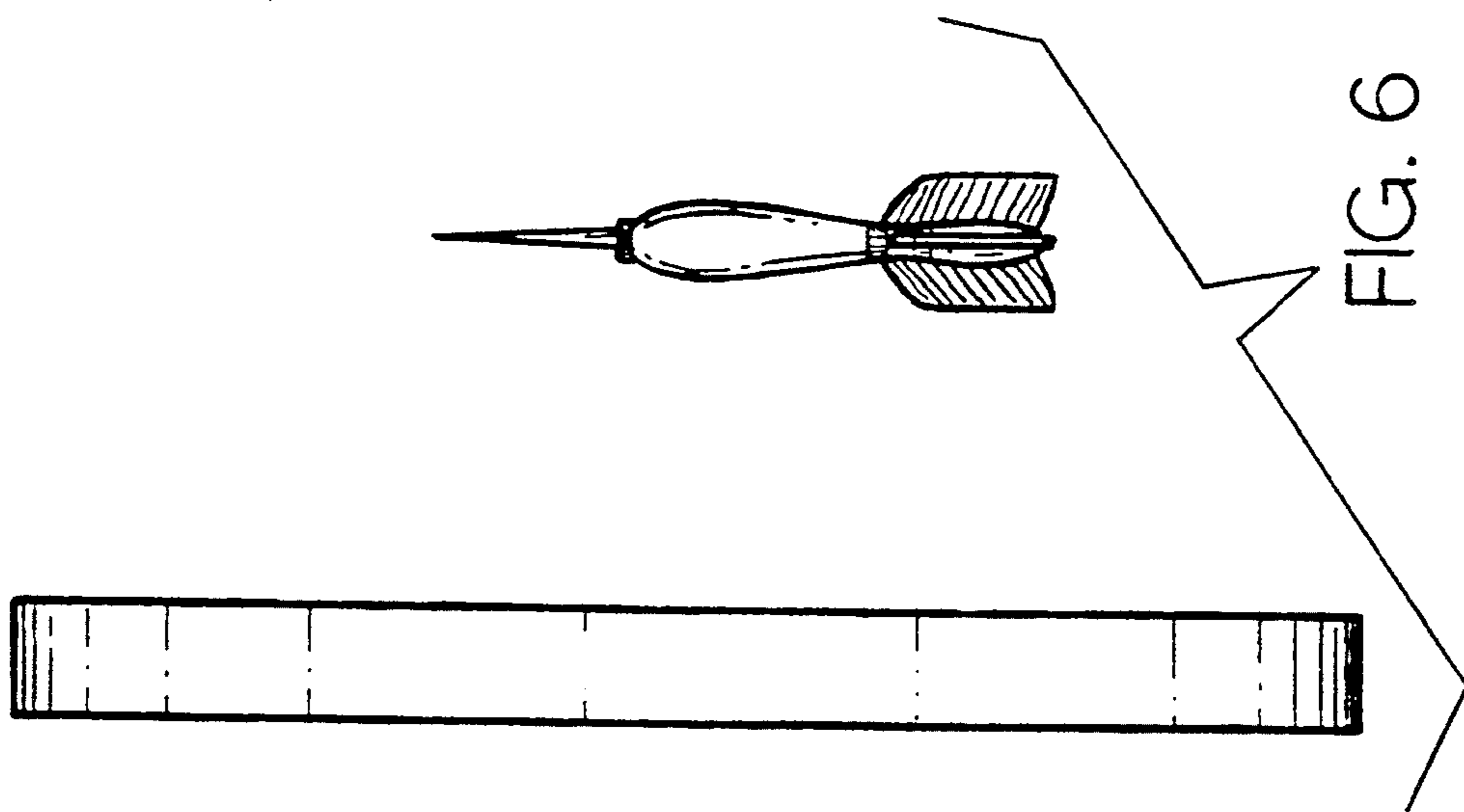

FIG. 6