



US00D354074S

United States Patent [19]

Ono et al.

[11] Patent Number: **Des. 354,074**

[45] Date of Patent: **** Jan. 3, 1995**

- [54] **ELECTRONIC CASH REGISTER**
- [75] Inventors: **Junichi Ono; Atsushi Shigemura,**
both of Tokyo, Japan
- [73] Assignee: **Casio Computer Co., Ltd., Tokyo,**
Japan
- [**] Term: **14 Years**
- [21] Appl. No.: **2,560**
- [22] Filed: **Dec. 15, 1992**
- [52] U.S. Cl. **D18/4**
- [58] Field of Search **D18/1, 2, 4, 3;**
D14/100, 105, 106, 113; 235/1 D, 1 E, 2, 4, 7 R,
10, 375, 379, 380, 418, 145; 364/404, 405

- [56] **References Cited**
- U.S. PATENT DOCUMENTS**
- D. 304,444 11/1989 Ikeya **D14/105**
- D. 338,877 8/1993 Savio **D18/4 X**
- 4,841,412 6/1989 Heys, Jr. et al. **235/145 R X**

Primary Examiner—Nelson C. Holtje
Assistant Examiner—Caron D. Veynar

Attorney, Agent, or Firm—Frishauf, Holtz, Goodman & Woodward

[57] CLAIM

The ornamental design for an electronic cash register, as shown and described.

DESCRIPTION

FIG. 1 is a front elevational view of an electronic cash register showing our new design;
 FIG. 2 is a right side elevational view thereof;
 FIG. 3 is a left side elevational view thereof;
 FIG. 4 is a top plan view thereof;
 FIG. 5 is a bottom plan view thereof;
 FIG. 6 is a rear elevational view thereof;
 FIG. 7 is a perspective view thereof;
 FIG. 8 is a perspective view of a second embodiment of our new design of FIGS. 1-7;
 FIG. 9 is a top plan view thereof, the bottom plan view being the same as FIG. 5;
 FIG. 10 is a front elevational view thereof;
 FIG. 11 is a rear elevational view thereof;
 FIG. 12 is a left side elevational view thereof; and,
 FIG. 13 is a right side elevational view thereof.

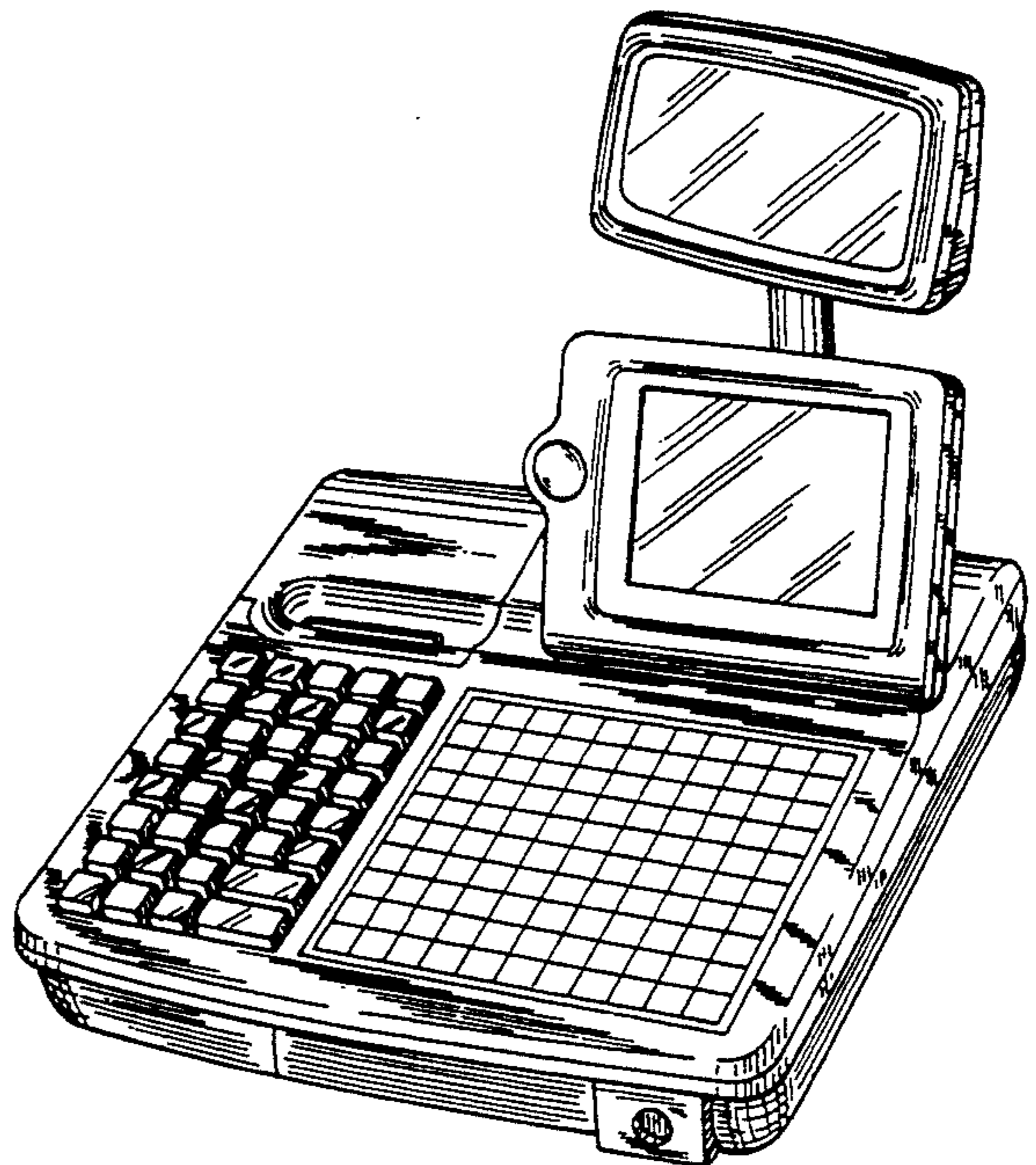
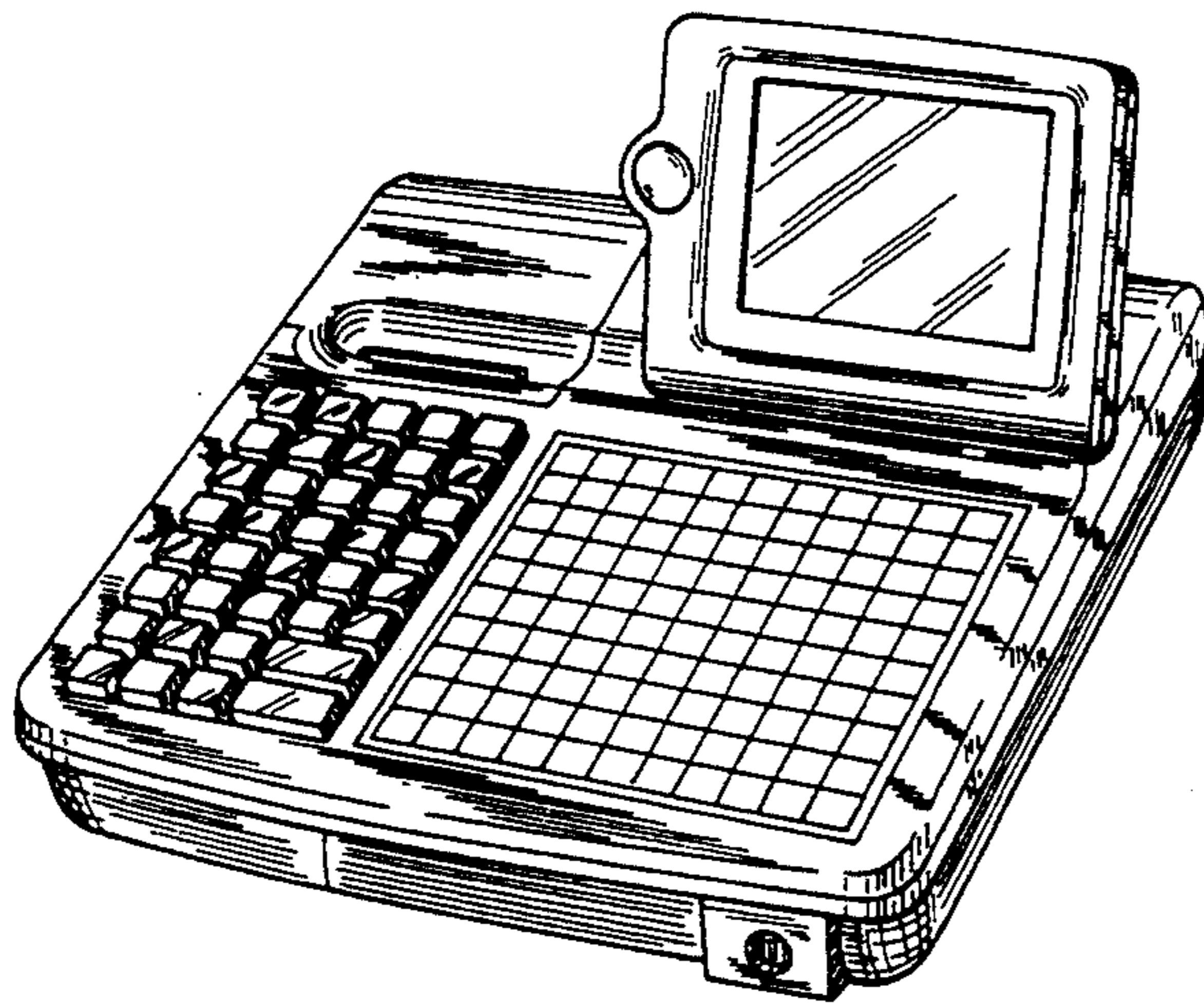

FIG.1

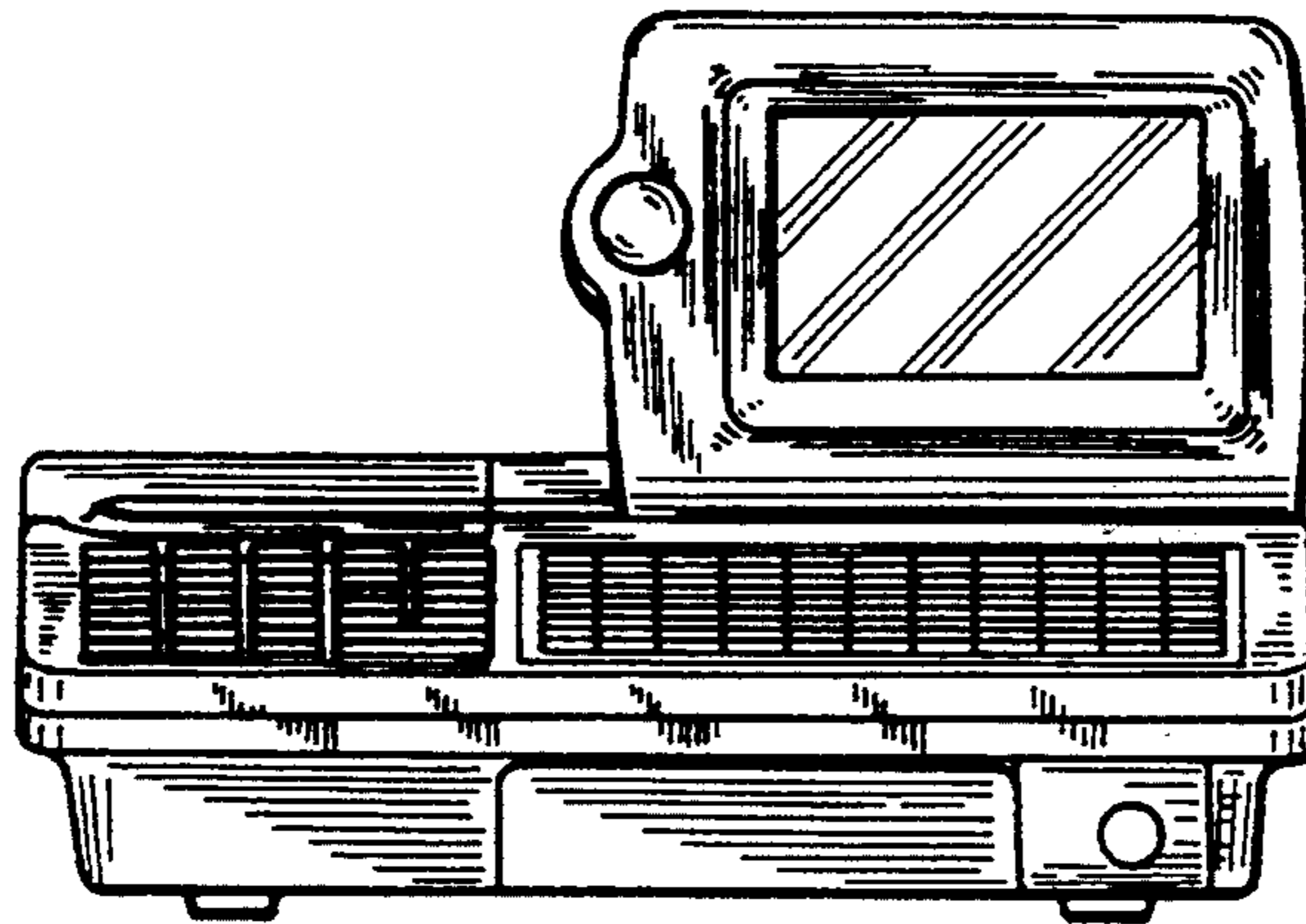

FIG.4

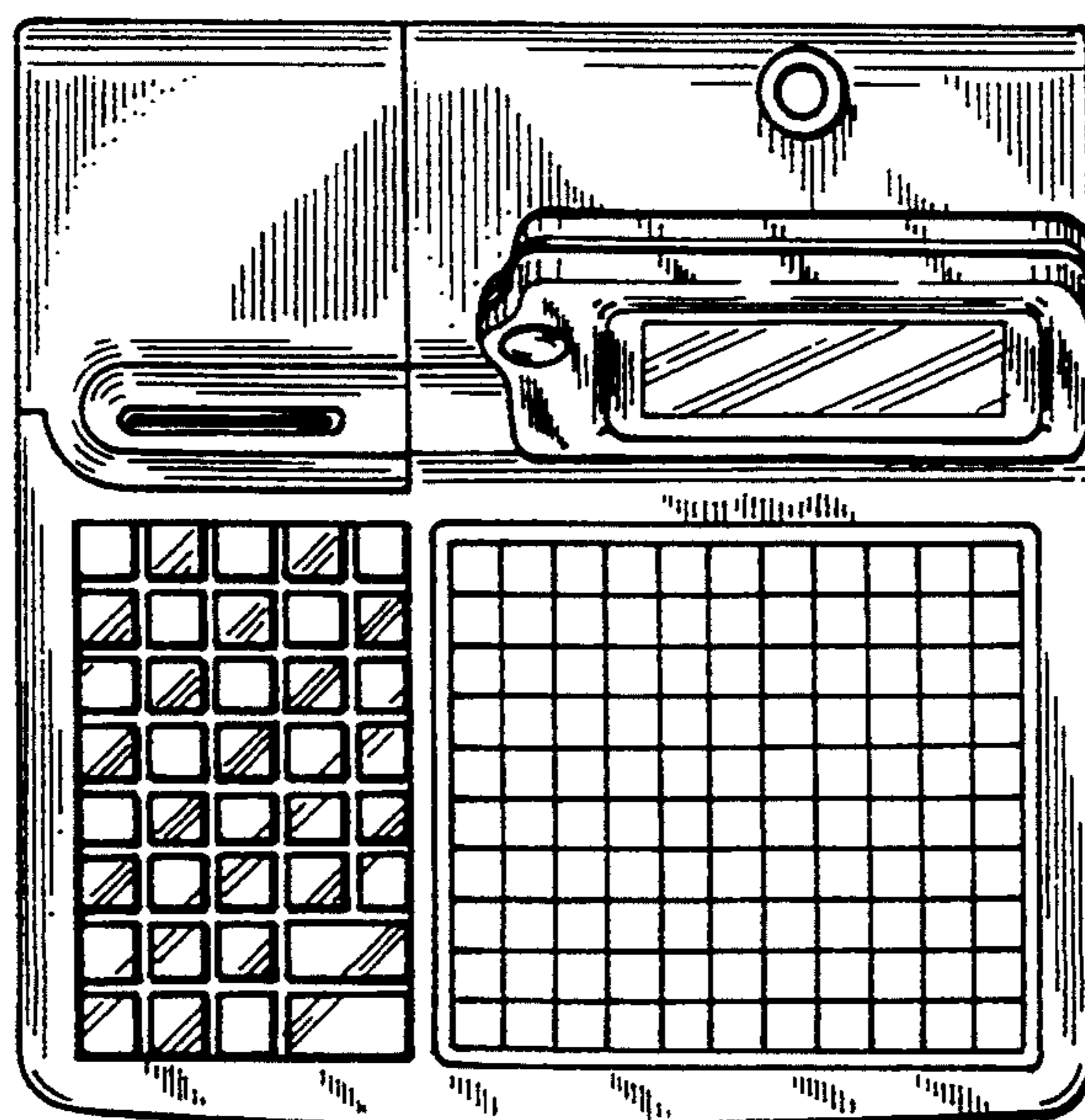

FIG.3

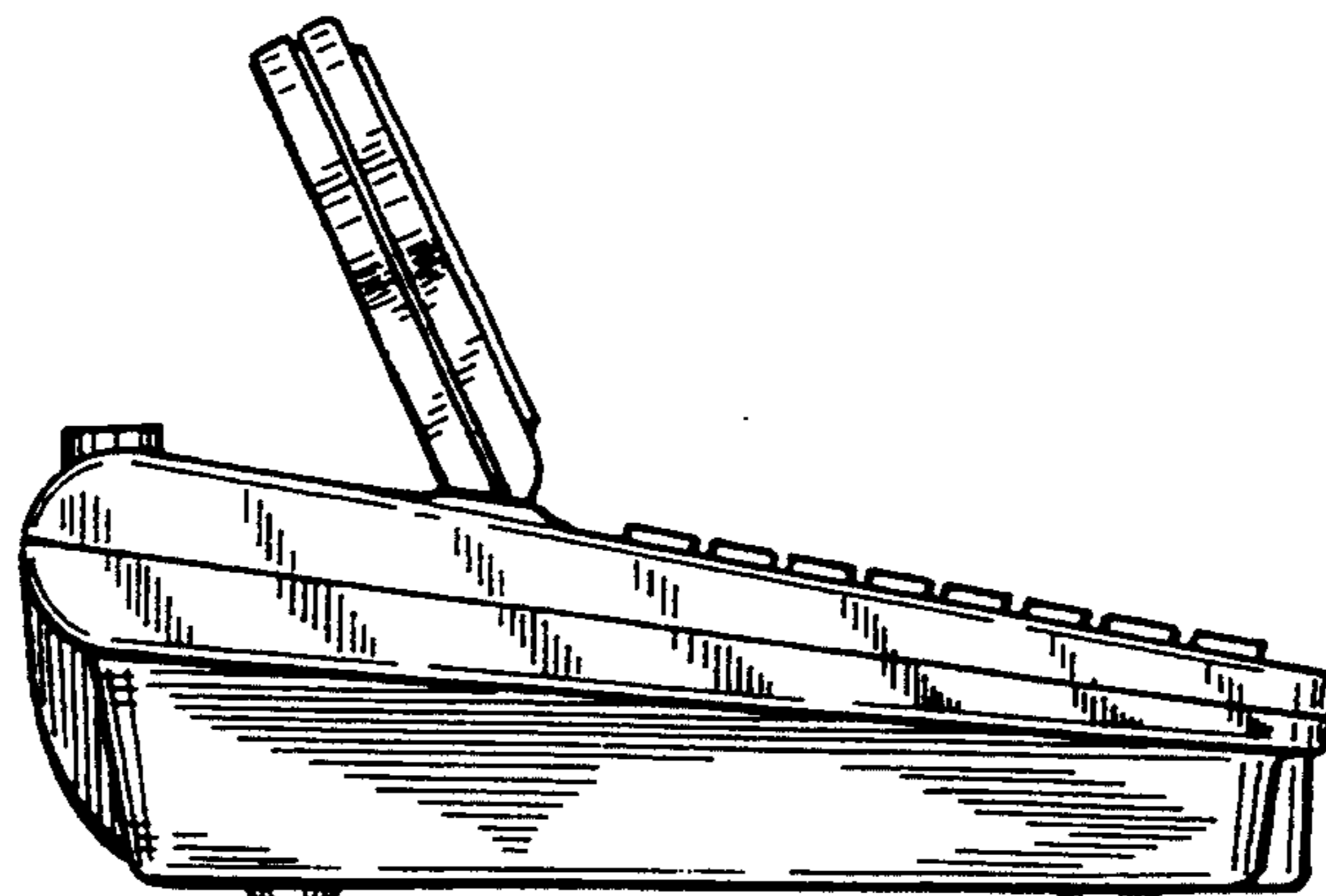

FIG.2

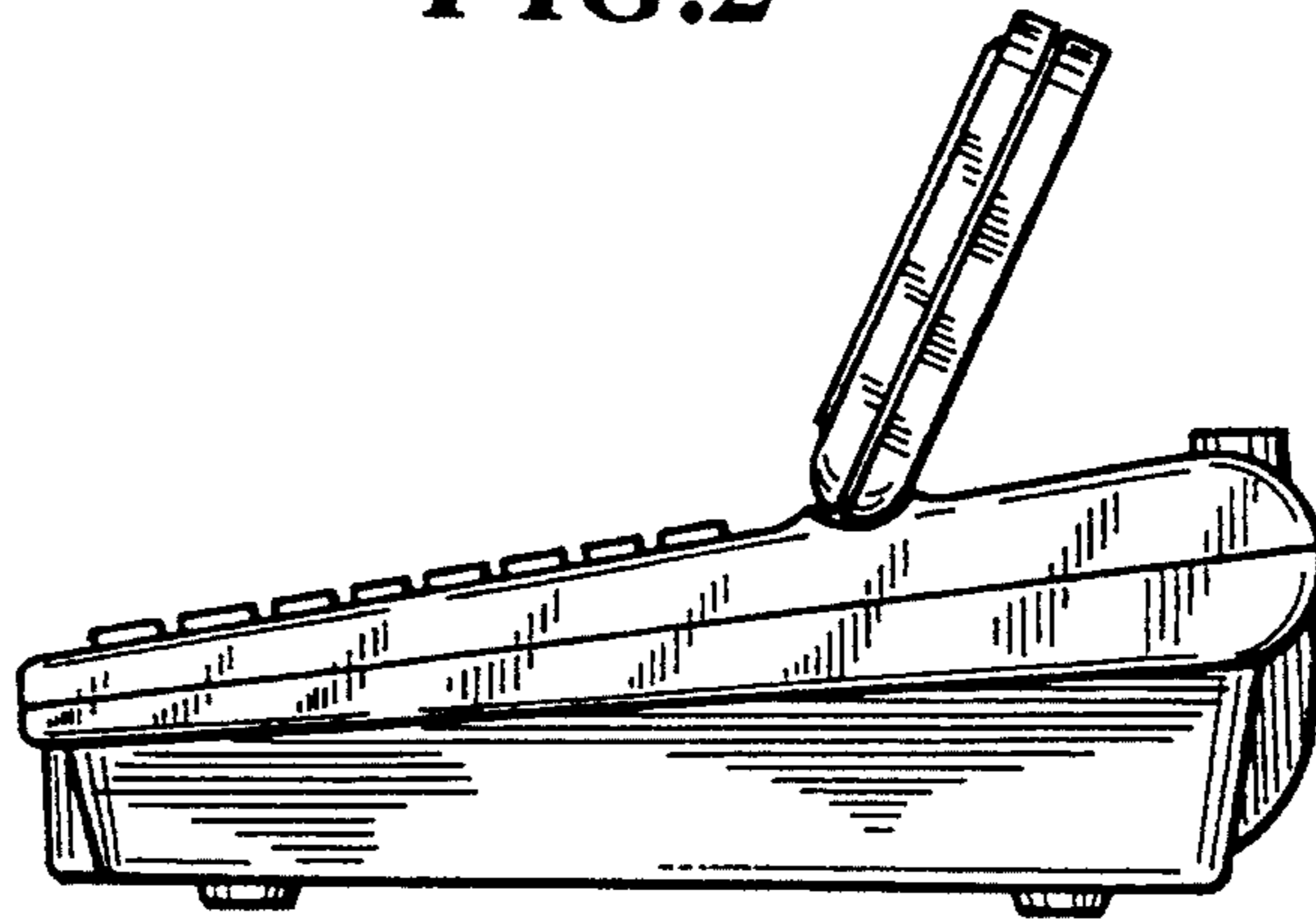

FIG.5

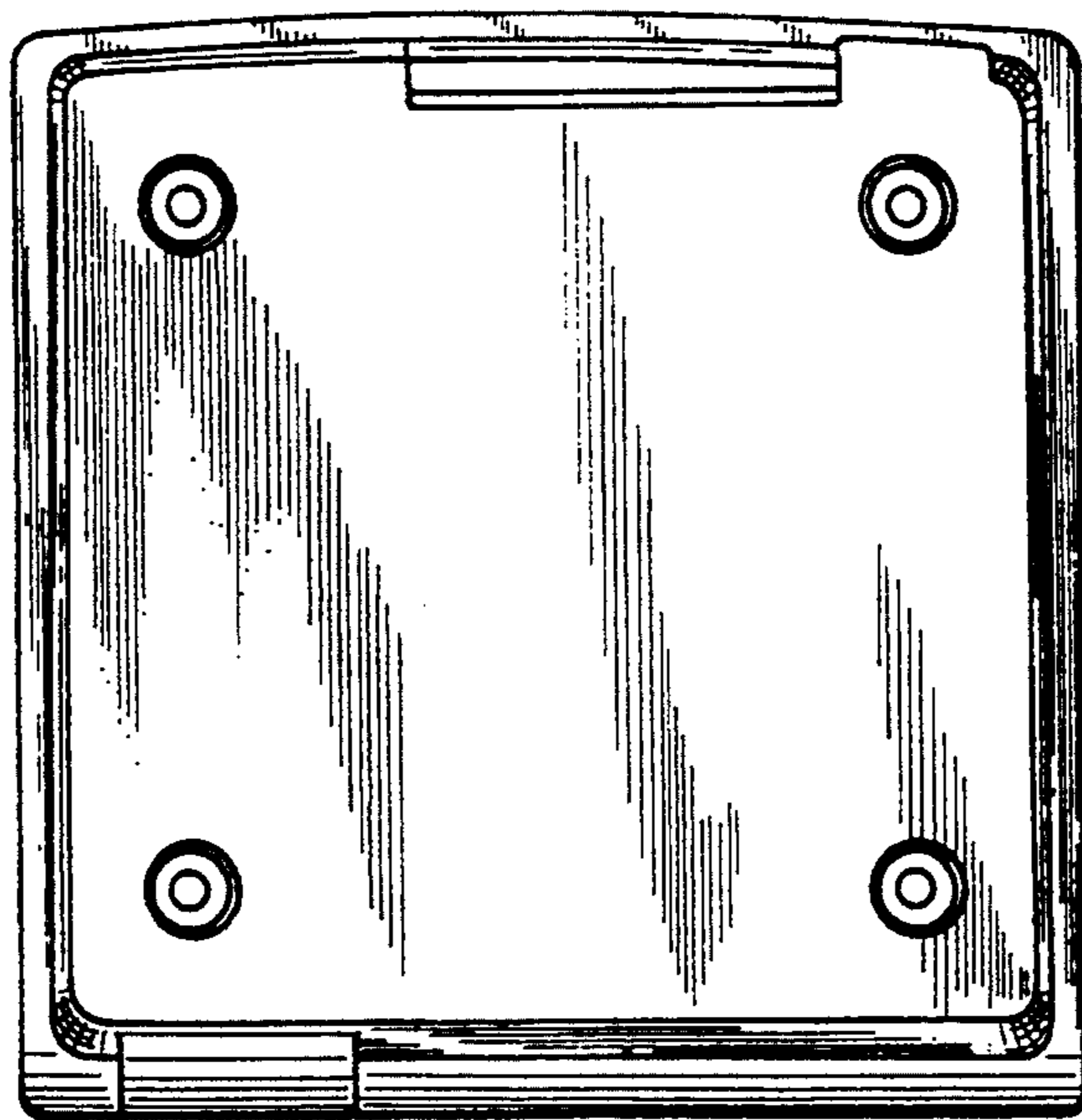

FIG.6

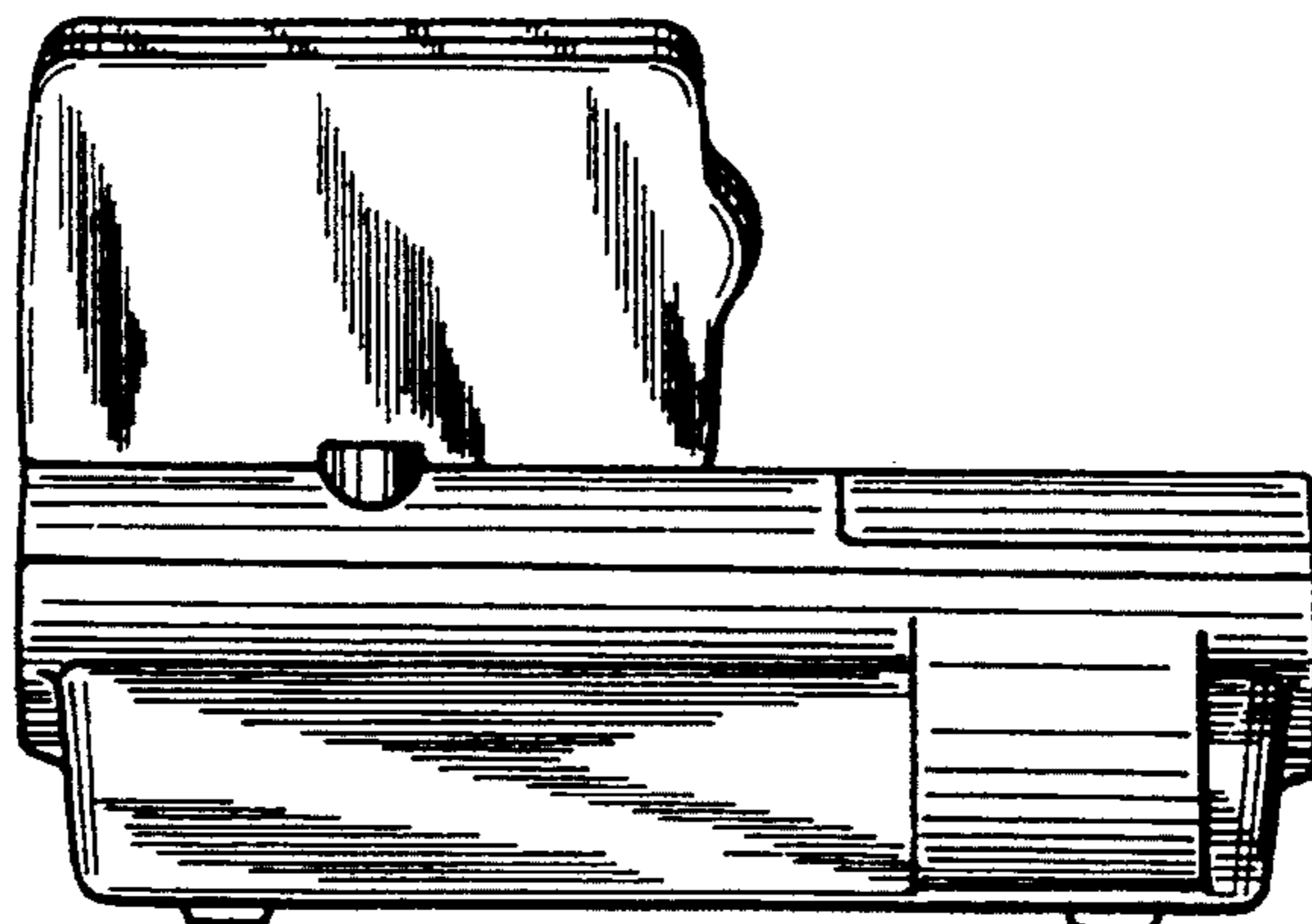

FIG.7

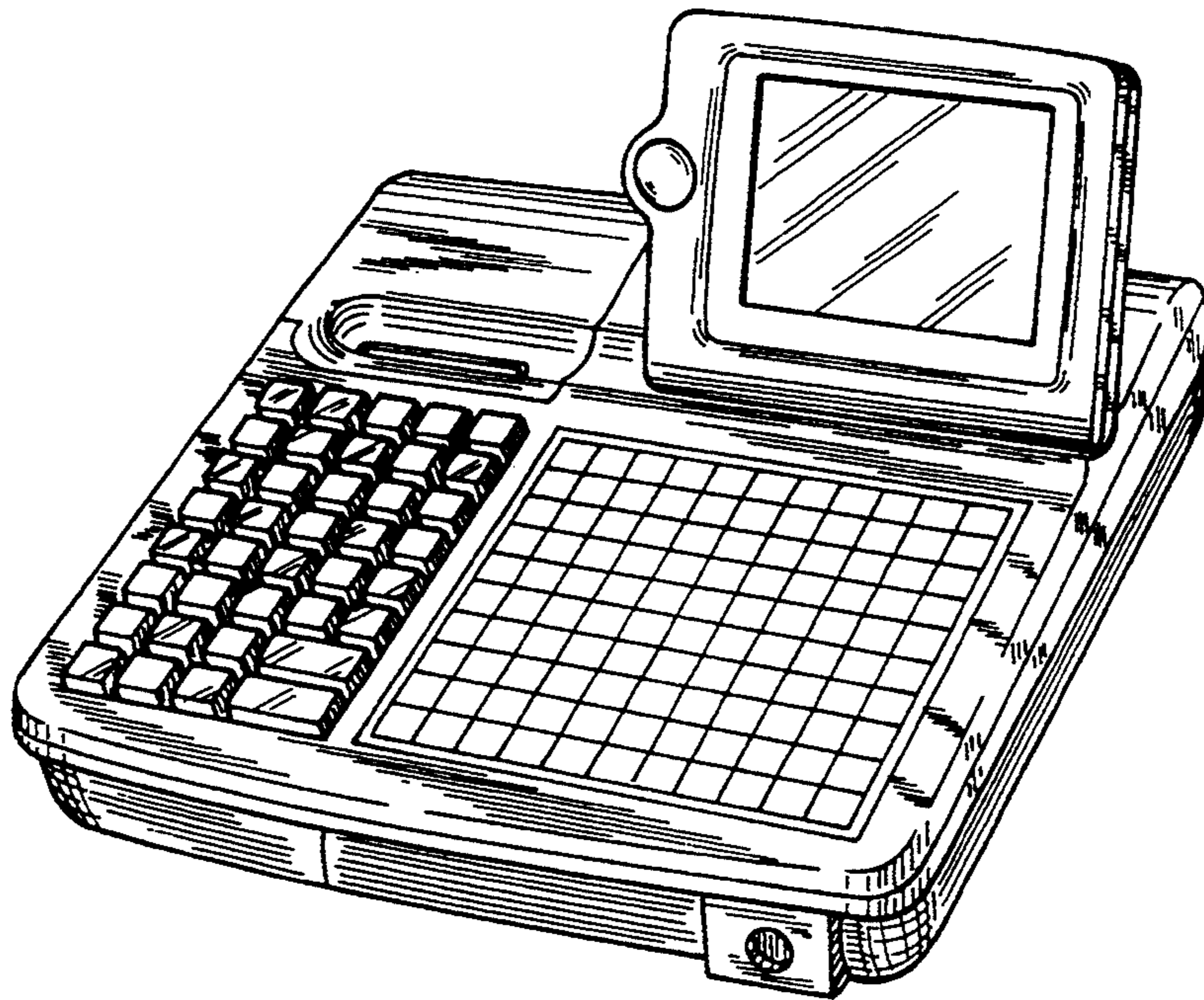

FIG. 8

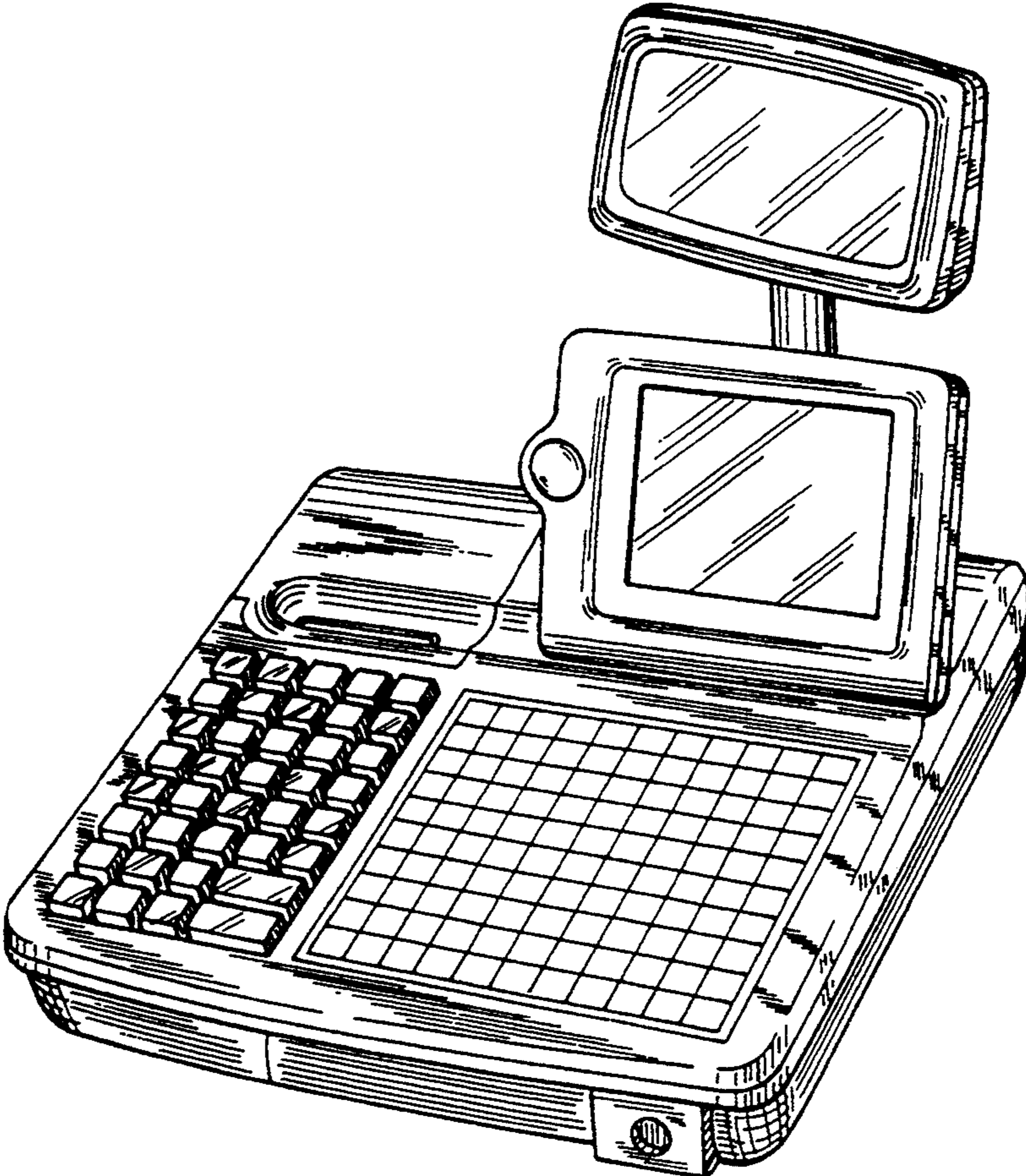

FIG. 9

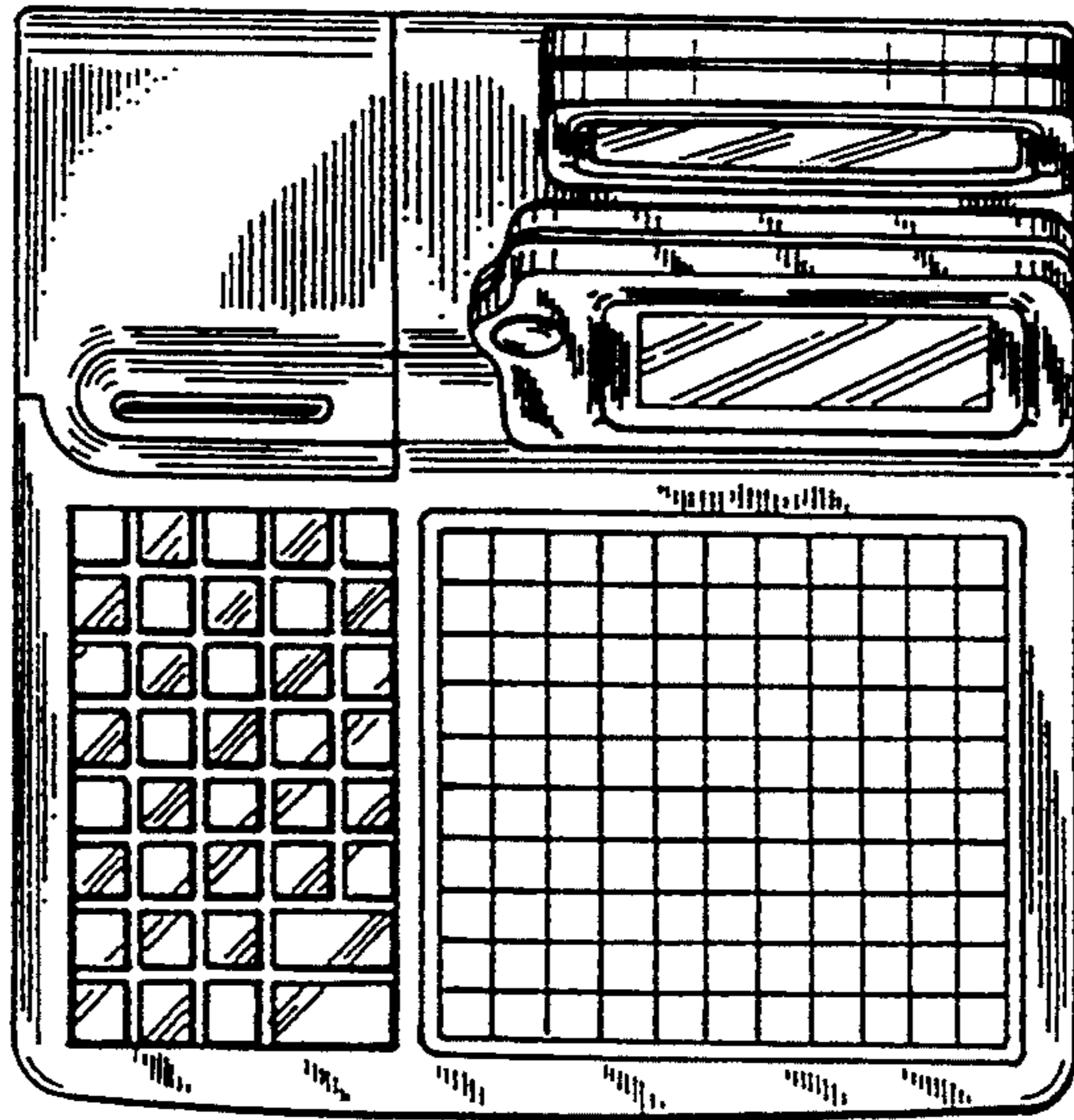

FIG. 10

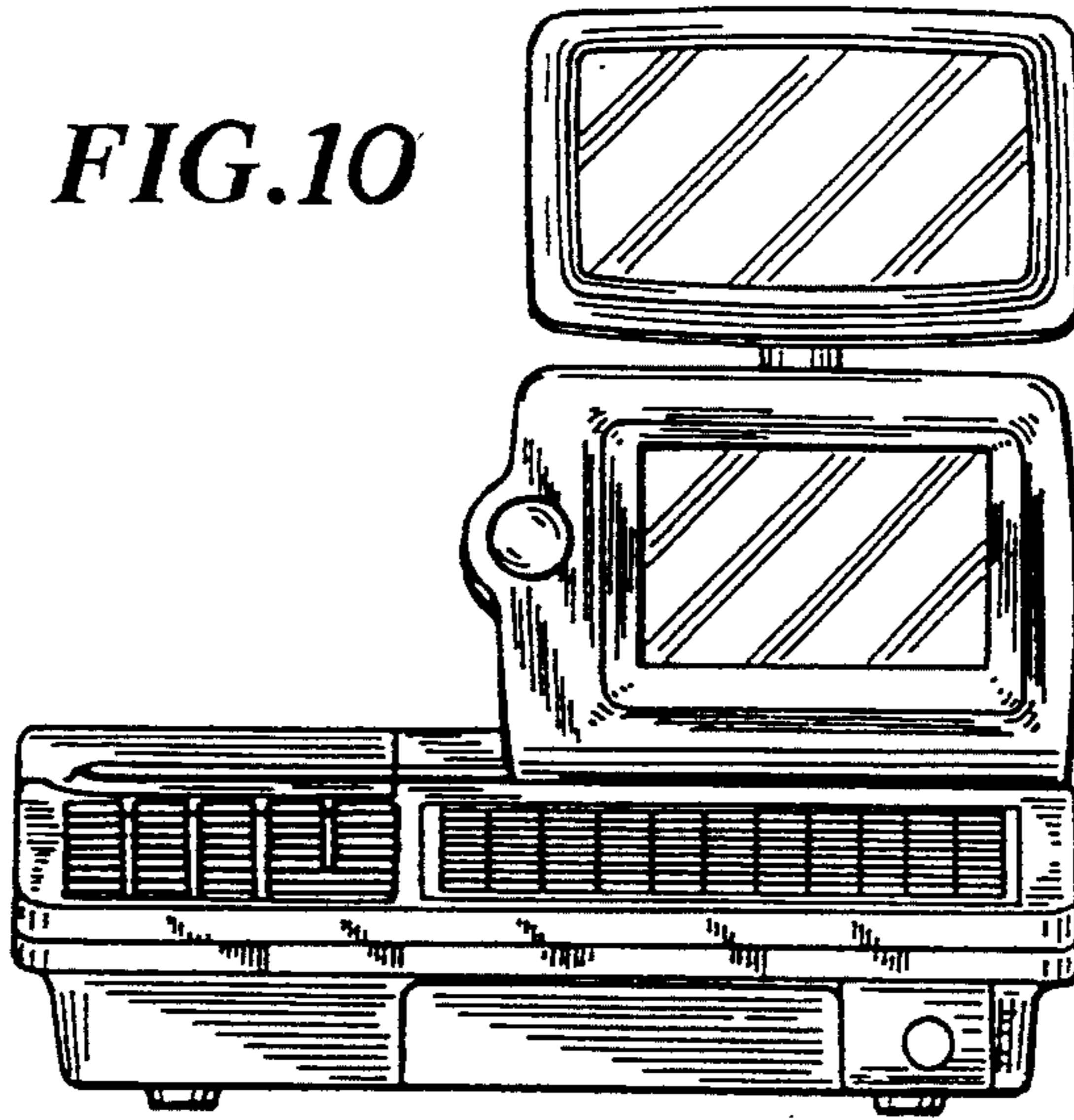

FIG. 11

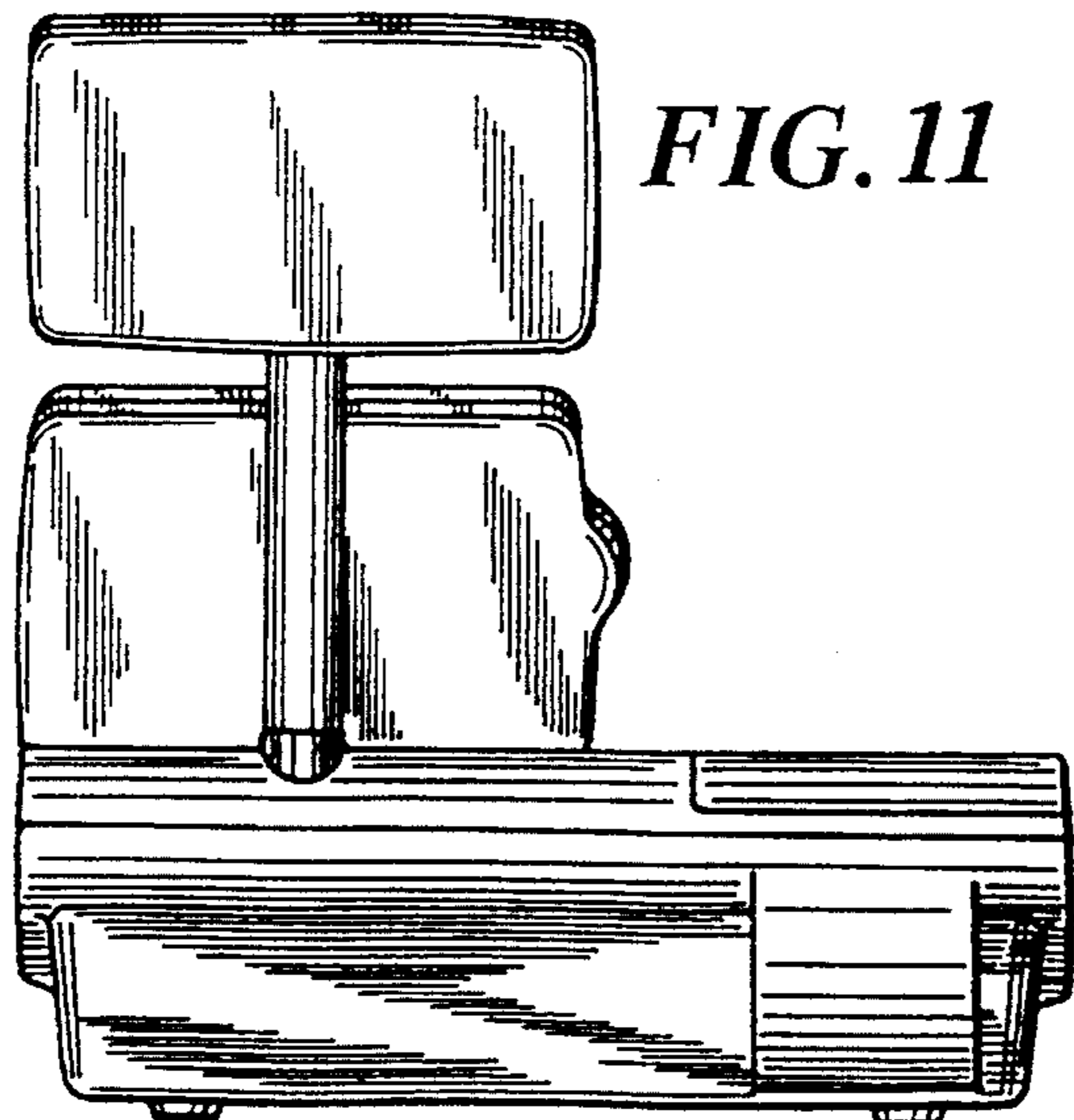

FIG. 12

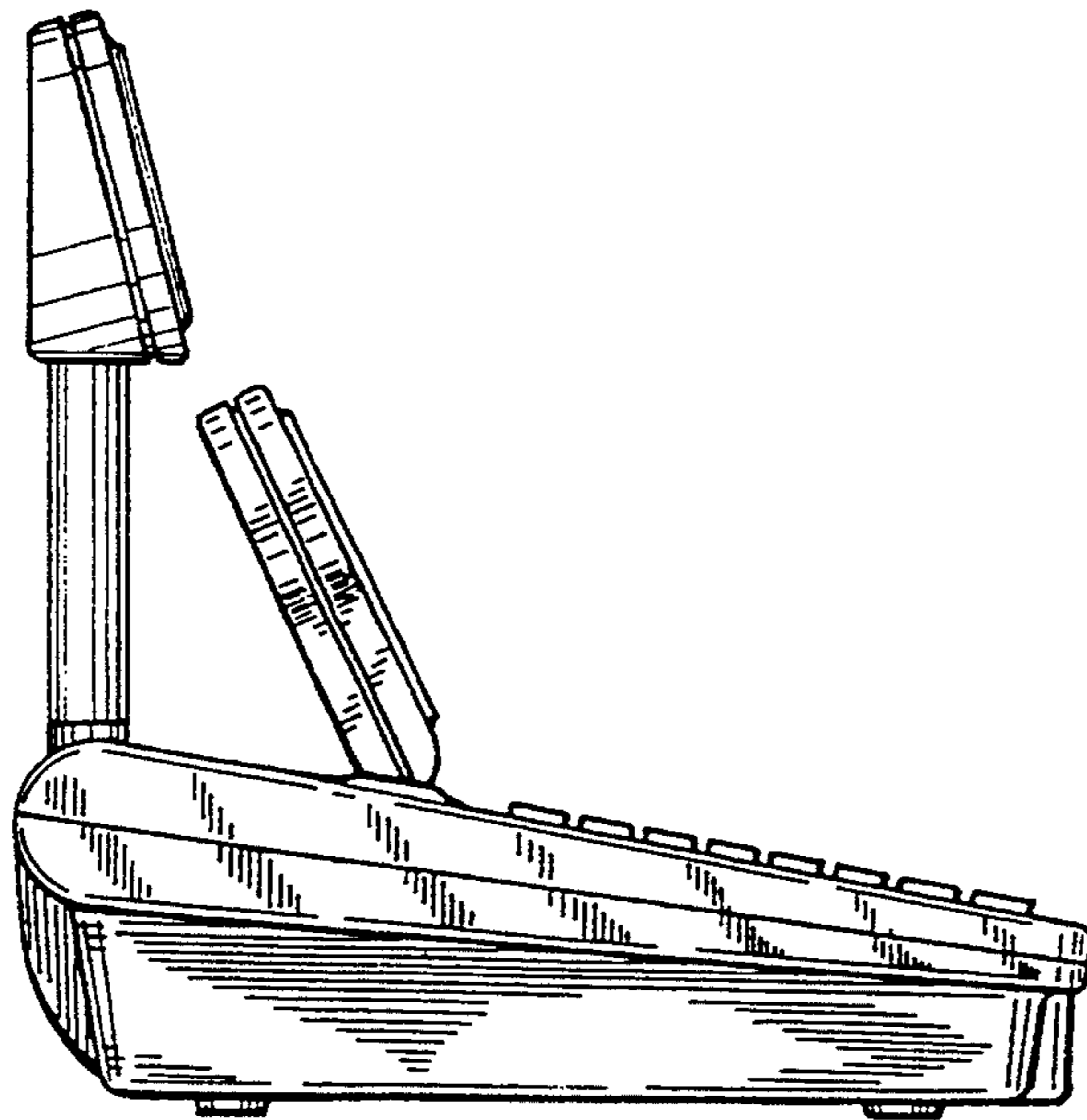

FIG. 13

