



US00D354048S

United States Patent [19]

Kimura et al.

[11] Patent Number: **Des. 354,048**

[45] Date of Patent: **** Jan. 3, 1995**

[54] **NOTEBOOK PERSONAL COMPUTER**

[75] Inventors: **Koji Kimura; Yoshihiro Ueda; Takeshi Ichimaru; Yukihiko Oashi,** all of Kawasaki, Japan

[73] Assignee: **Fujitsu Limited, Kawasaki, Japan**

[**] Term: **14 Years**

[21] Appl. No.: **6,883**

[22] Filed: **Apr. 12, 1993**

[30] **Foreign Application Priority Data**

Nov. 19, 1992 [JP] Japan 4-34154

[52] U.S. Cl. **D14/106**

[58] Field of Search D14/100, 101, 106, 113, D14/115, 124-127; D18/1, 7, 11, 12; 235/145 A, 145 R; 341/22, 23; 345/104, 156, 168, 173, 901, 905; 361/679-686; 364/708.1, 709.04, 709.12; 400/486, 489

[56] **References Cited**

U.S. PATENT DOCUMENTS

D. 345,149	3/1994	Toedter et al.	D14/106
D. 345,550	3/1994	Iino	D14/106
D. 346,795	5/1994	Kaneko	D14/106
D. 347,214	5/1994	You-Chi	D14/106

Primary Examiner—Freda S. Nunn
Attorney, Agent, or Firm—Staas & Halsey

[57] **CLAIM**

The ornamental design for a notebook personal computer, as shown and described.

DESCRIPTION

FIG. 1 is a front elevational view of our notebook personal computer design;
FIG. 2 is a rear elevational view thereof;
FIG. 3 is a left side elevational view thereof;
FIG. 4 is a right side elevational view thereof;
FIG. 5 is a top plan view thereof;
FIG. 6 is a bottom plan view thereof; and,
FIG. 7 is a slightly reduced perspective view thereof with the cover closed.

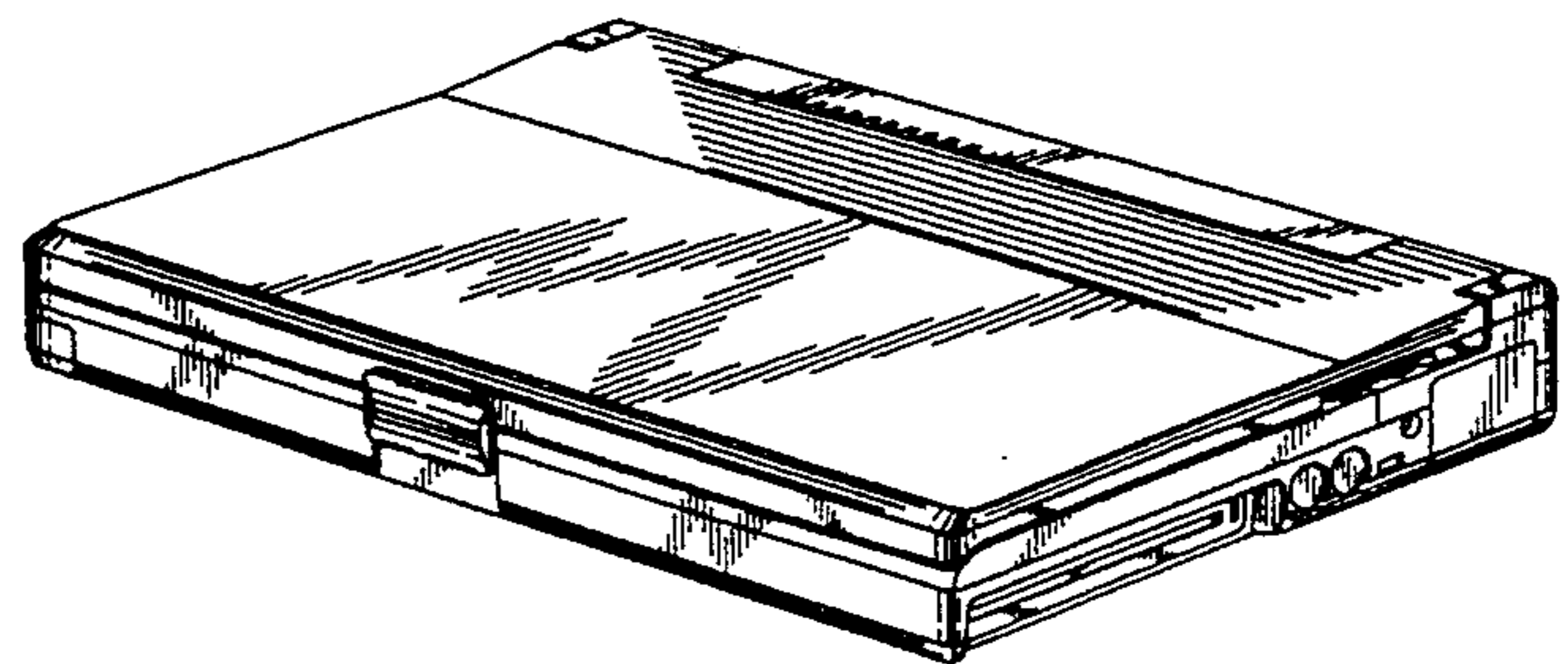
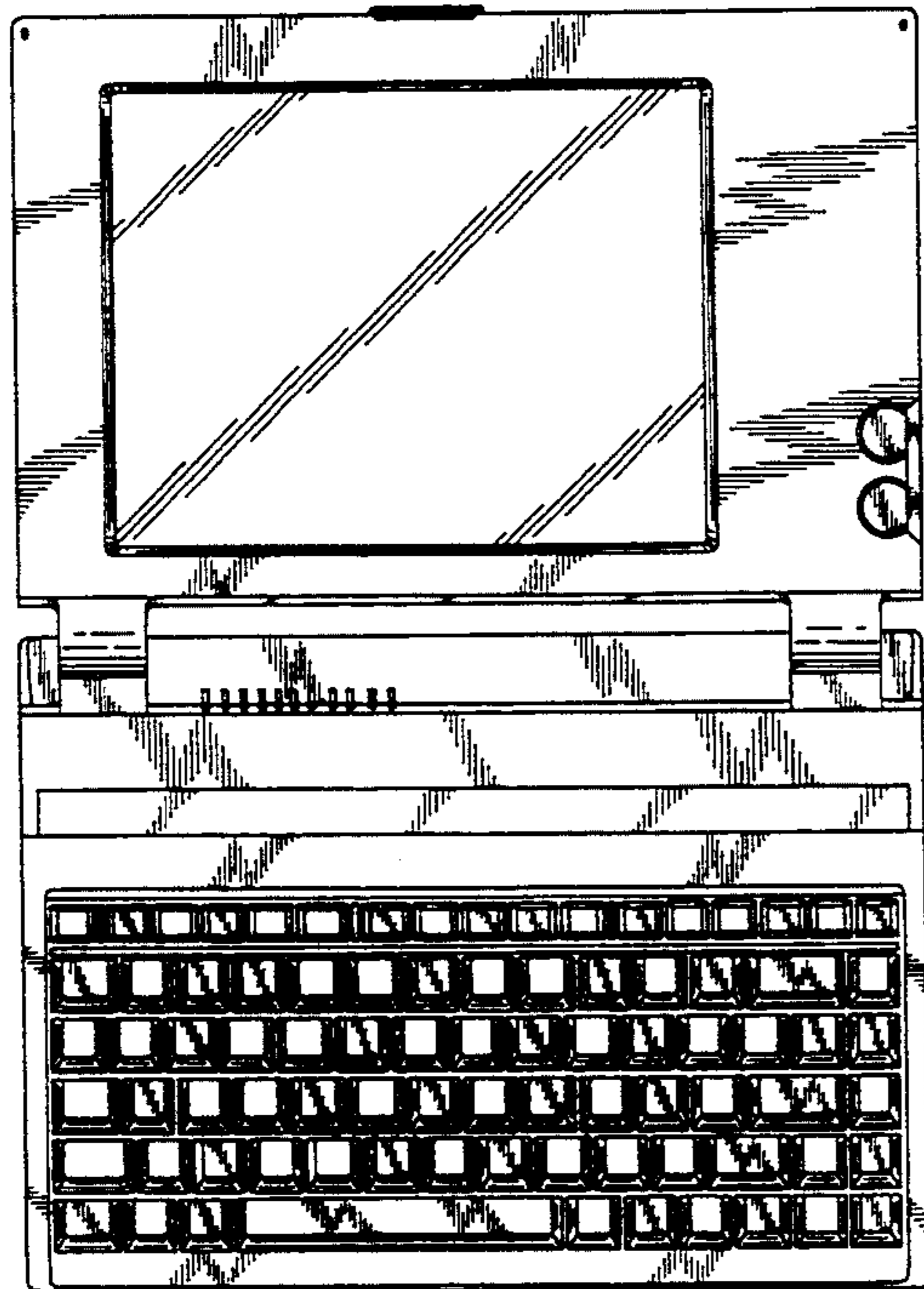

FIG. 1

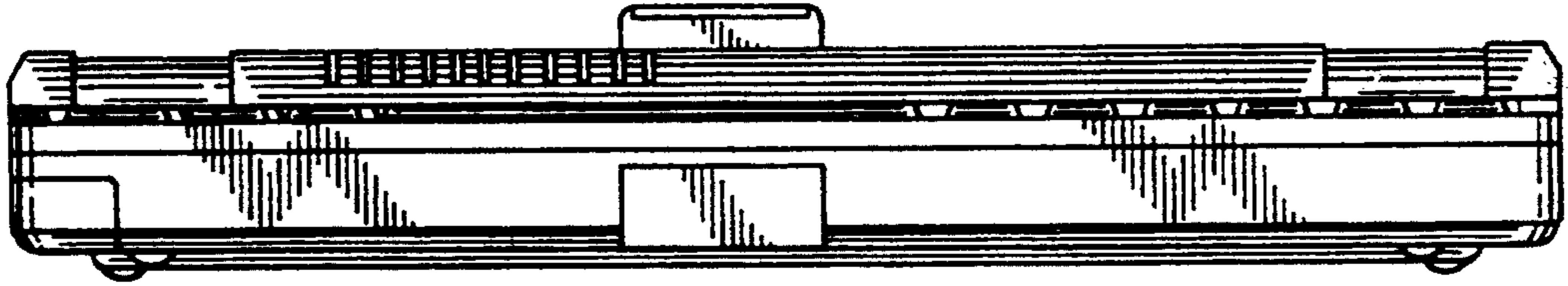

FIG. 2

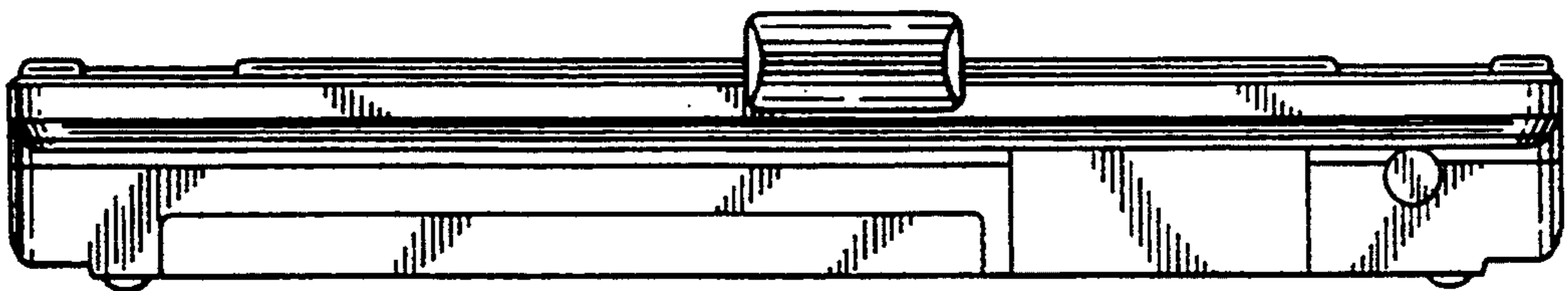

FIG. 3

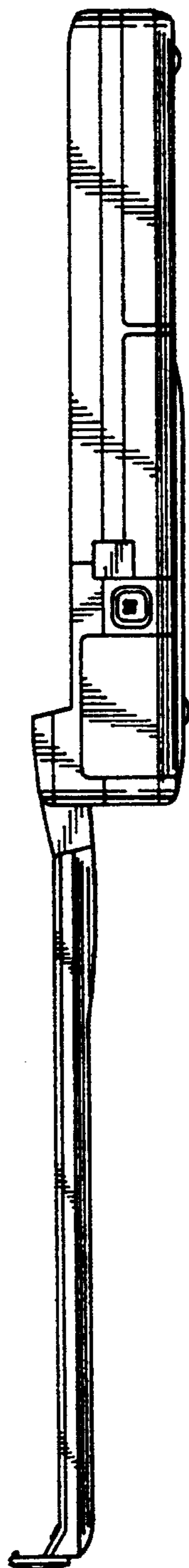

FIG. 4

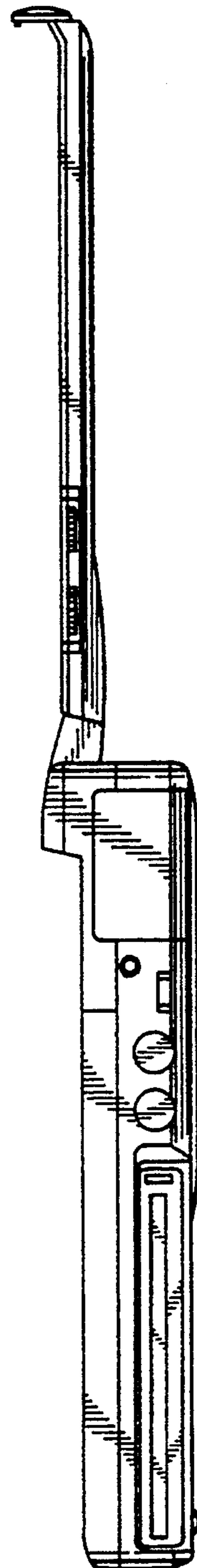

FIG. 5

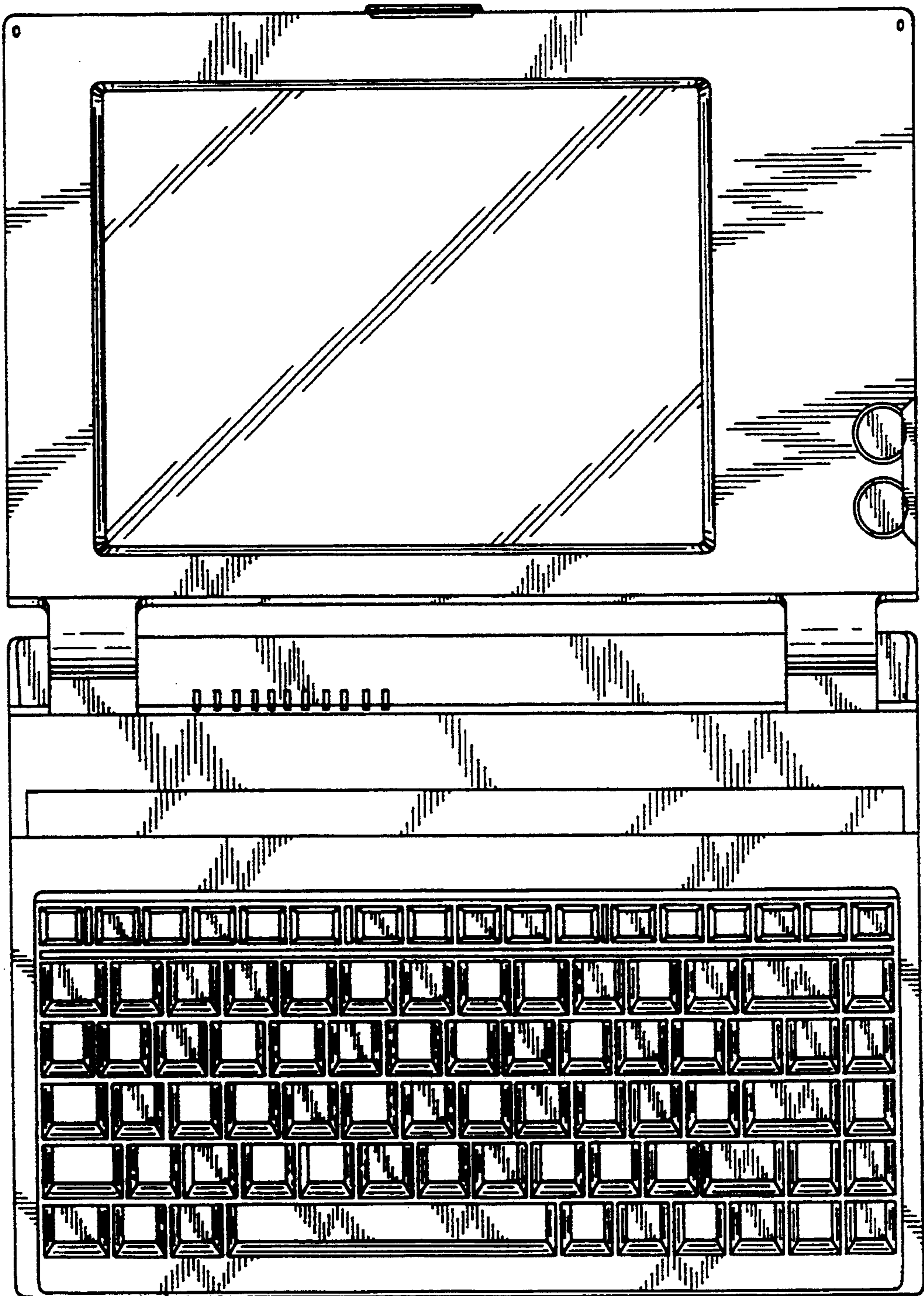

FIG. 6

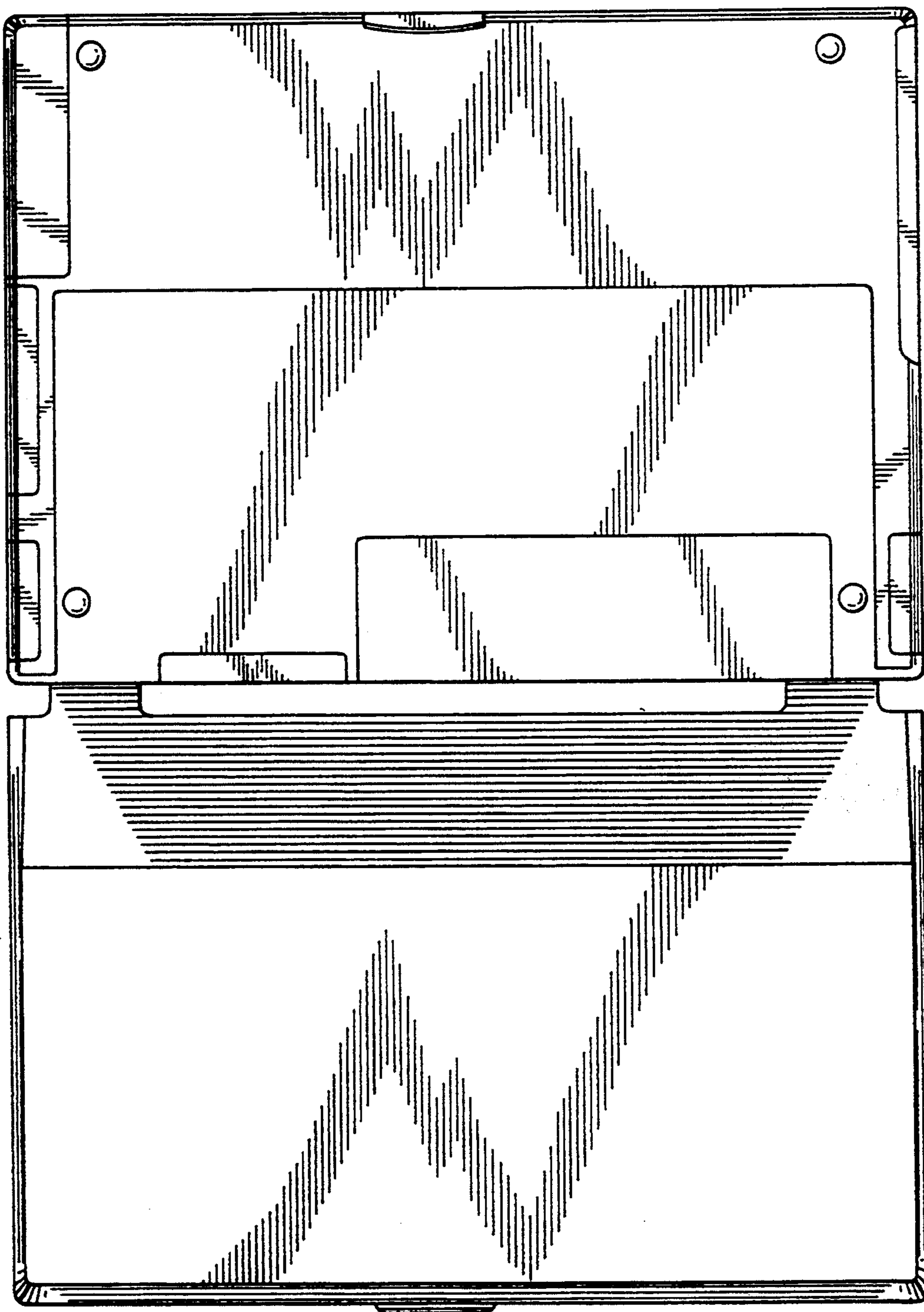

FIG. 7

