



US00D353992S

# United States Patent [19]

[11] Patent Number: **Des. 353,992**

Dombrowski et al.

[45] Date of Patent: **\*\* Jan. 3, 1995**

[54] **DOOR MOUNTED SEASONAL DECORATION HANGER**

3,981,471 9/1976 Currier ..... 248/317  
4,667,913 5/1987 Peelle et al. .... 248/317 X

[75] Inventors: **Walter Dombrowski; Thomas Herrick**, both of Alpharetta, Ga.

*Primary Examiner*—Wallace R. Burke  
*Assistant Examiner*—H. Baynham  
*Attorney, Agent, or Firm*—James A. Hinkle

[73] Assignee: **H & D Designs, Inc.**, Alpharetta, Ga.

[\*\*] Term: **14 Years**

[57] **CLAIM**

[21] Appl. No.: **11,019**

The ornamental design for a door mounted seasonal decoration hanger, as shown.

[22] Filed: **Jul. 23, 1993**

**DESCRIPTION**

[52] U.S. Cl. .... **D8/373**

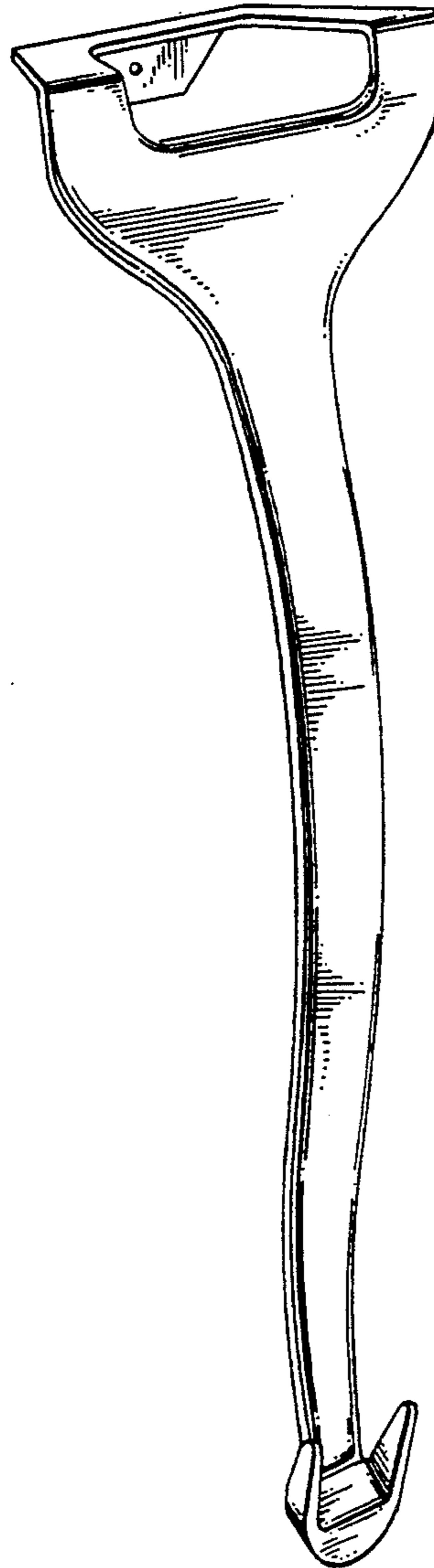
[58] Field of Search ..... **D8/373; 248/205.3, 317; D11/210**

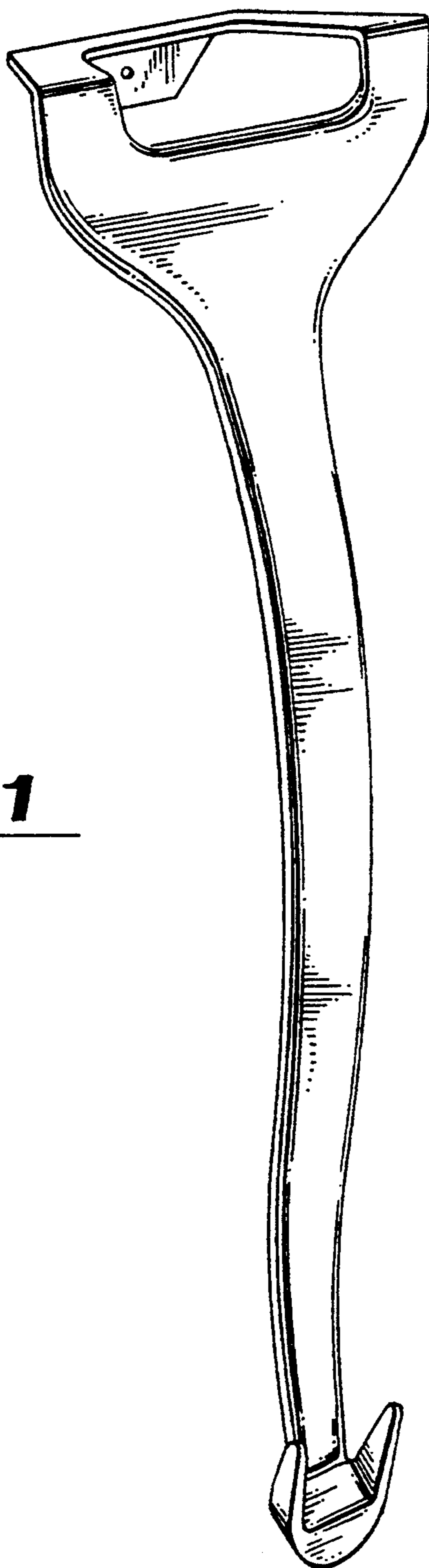
FIG. 1 is a perspective view of a door mounted seasonal decoration hanger showing our new design; FIG. 2 is a top plan view thereof; FIG. 3 is a front elevation view thereof; FIG. 4 is a left side elevation view thereof; FIG. 5 is a rear elevation view thereof; FIG. 6 is a bottom plan view thereof; and, FIG. 7 is a right side elevation view thereof.

[56] **References Cited**

**U.S. PATENT DOCUMENTS**

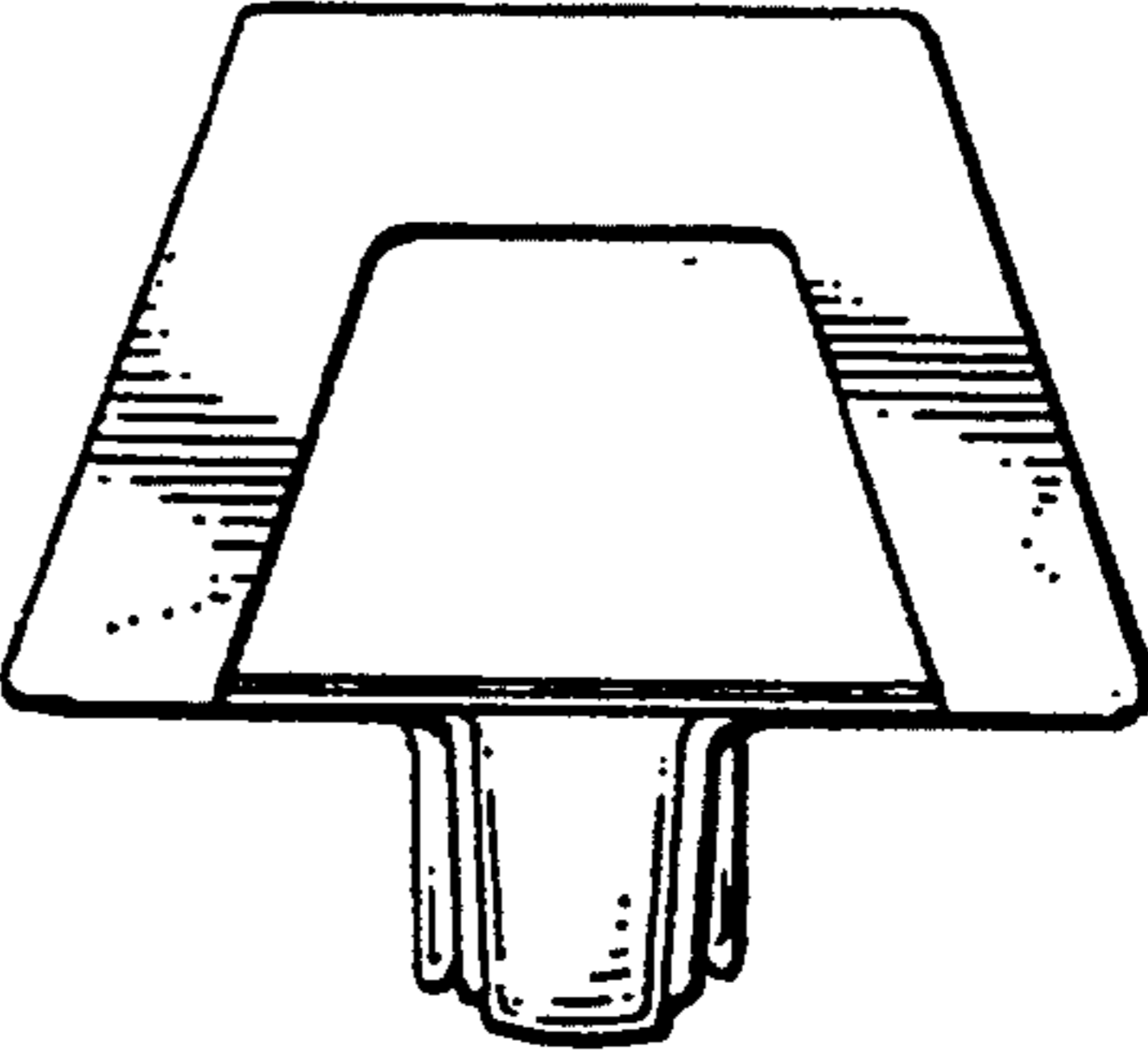
3,161,929 12/1964 Swett ..... 248/317  
3,484,070 12/1969 Horodko et al. .... 248/317



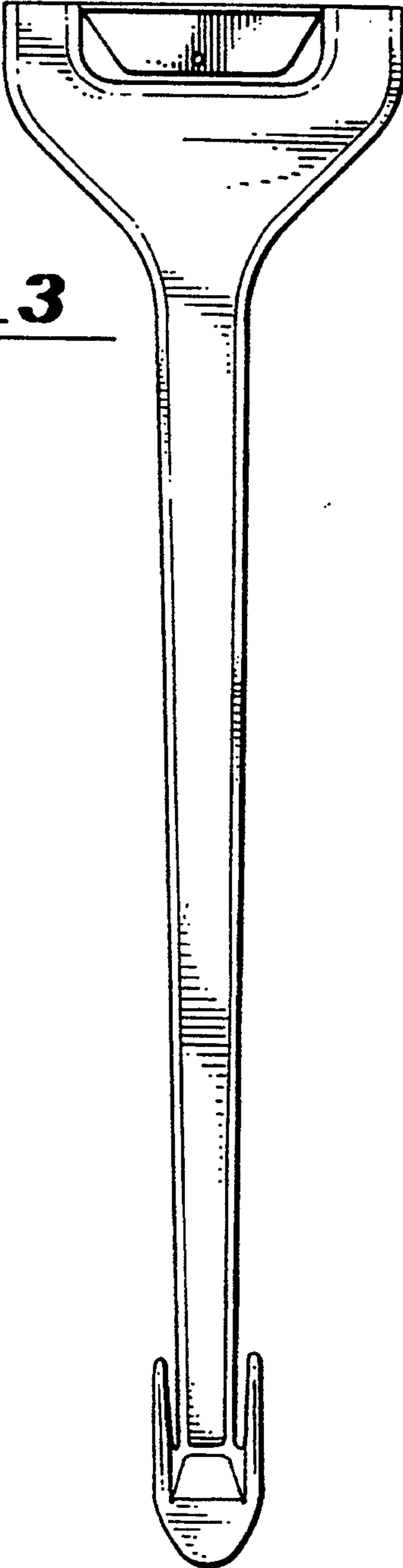


**Fig. 1**

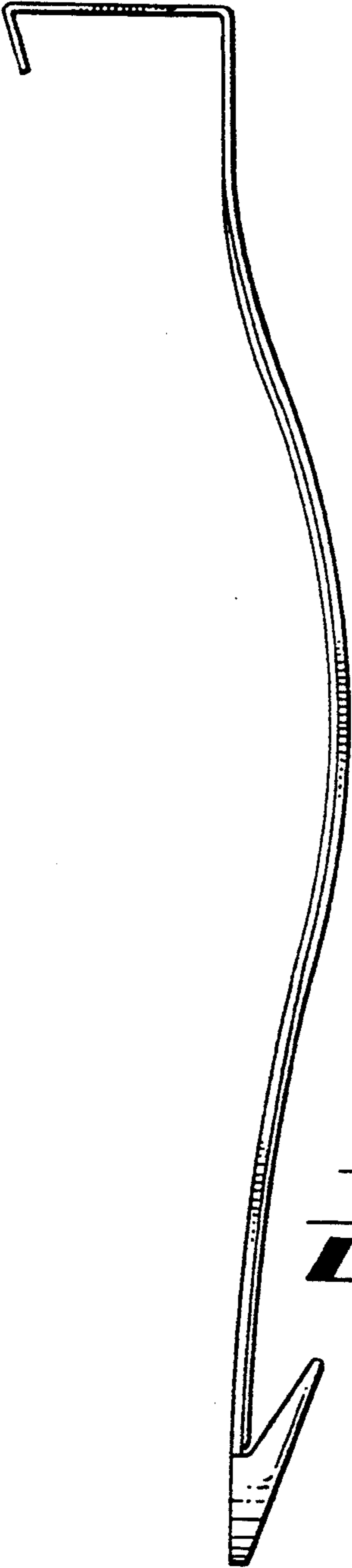
**Fig. 2**

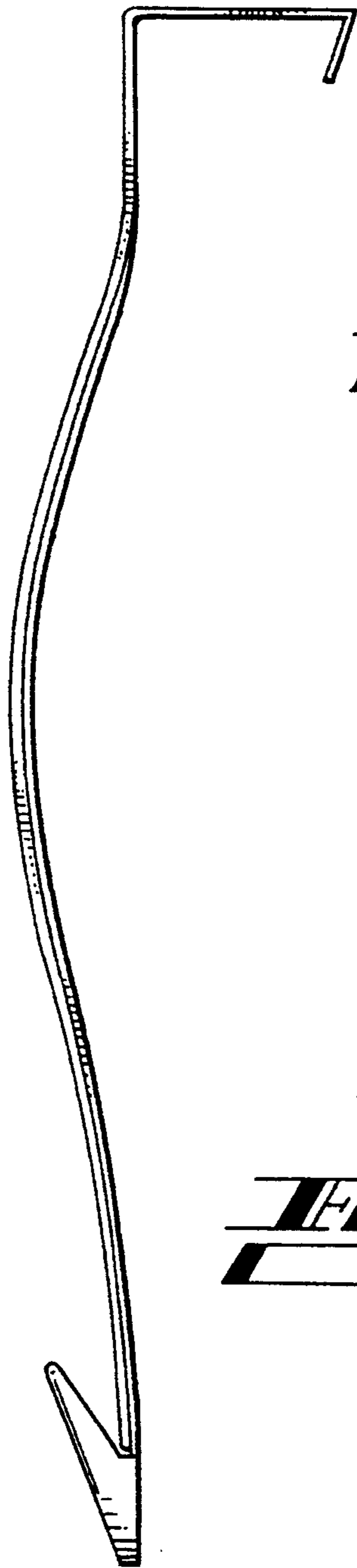


**Fig. 3**

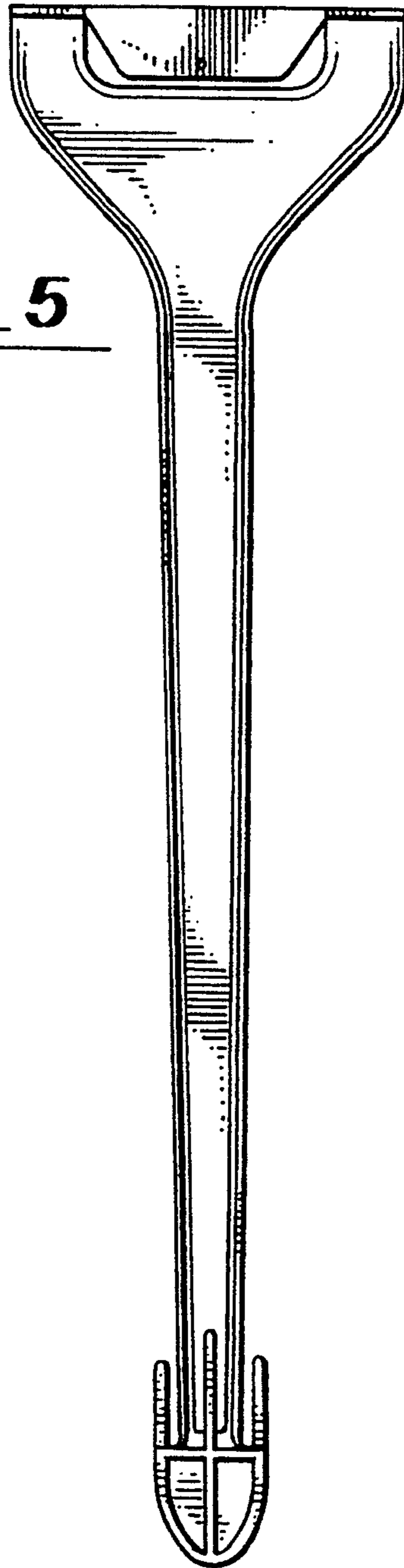


**Fig. 4**





**Fig. 7**



**Fig. 5**

**Fig. 6**

