



US00D353943S

United States Patent [19]

[11] Patent Number: **Des. 353,943**

Varin

[45] Date of Patent: **** Jan. 3, 1995**

[54] TIE RACK

4,723,665 2/1988 Benedict et al. D6/315
4,869,379 9/1989 Hawkrige 211/94

[76] Inventor: **Robert D. Varin**, 6135 Verner Ave.,
Sacramento, Calif. 95841

Primary Examiner—B. J. Bullock

[**] Term: **14 Years**

[57] **CLAIM**

[21] Appl. No.: **3,722**

The ornamental design for a tie rack, as shown and described.

[22] Filed: **Jan. 15, 1993**

DESCRIPTION

[52] U.S. Cl. **D6/317; D6/324**

FIG. 1 is a left side elevational view of the tie rack showing my new design;

[58] Field of Search **D6/315, 317, 320, 322, D6/324; 211/94, 95, 113, 115, 106, 1.3**

FIG. 2 is a right side elevational view thereof;

FIG. 3 is a rear elevational view thereof;

FIG. 4 is a front elevational view thereof;

FIG. 5 is a top plan view thereof;

FIG. 6 is a bottom plan view thereof; and,

FIG. 7 is a perspective view thereof, in its opened condition.

[56] **References Cited**

U.S. PATENT DOCUMENTS

D. 334,291 3/1993 Rooke D6/317
3,124,253 3/1964 Petrich 211/94
3,794,182 2/1974 Royeton 211/94

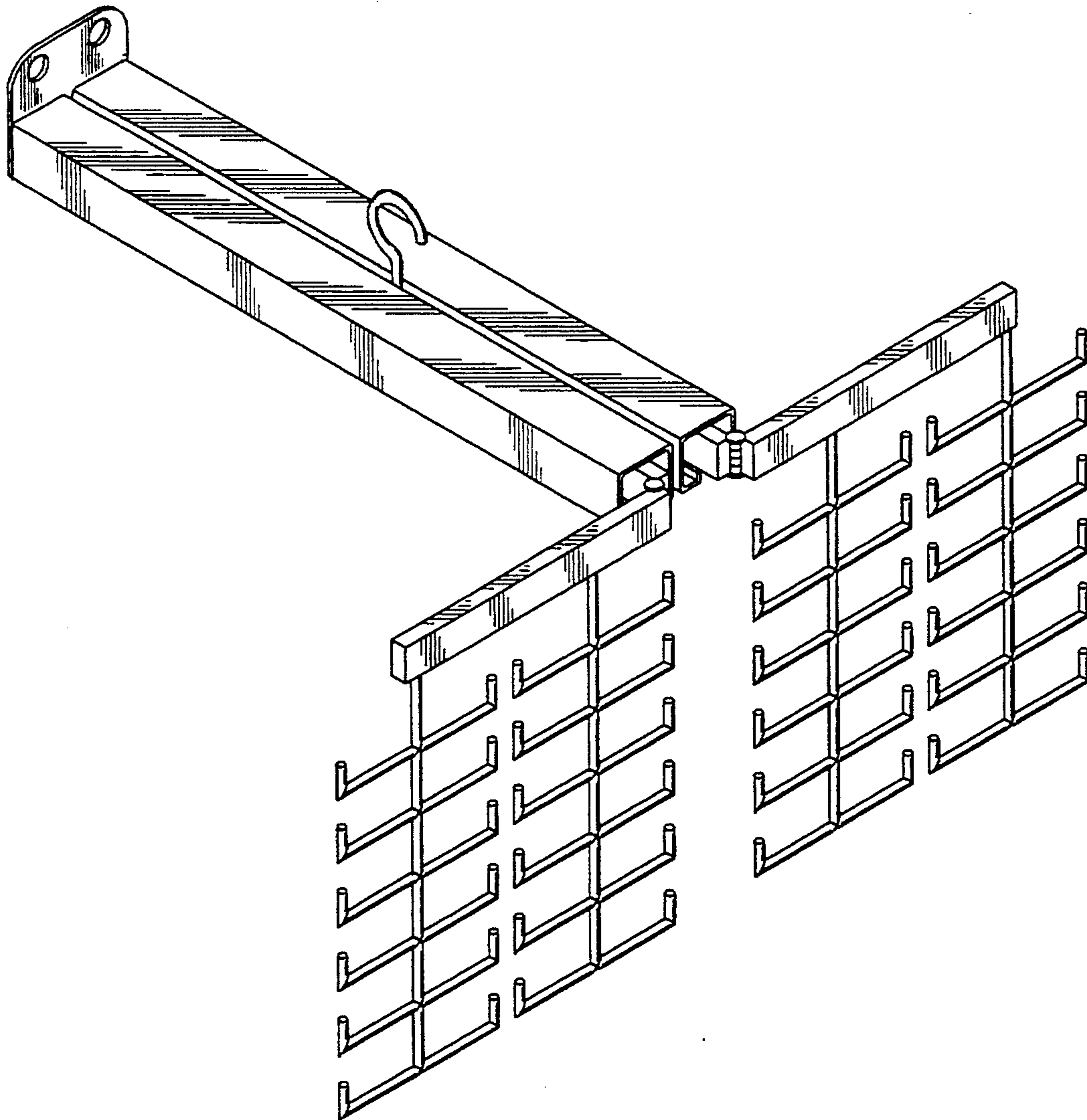

FIG. 1

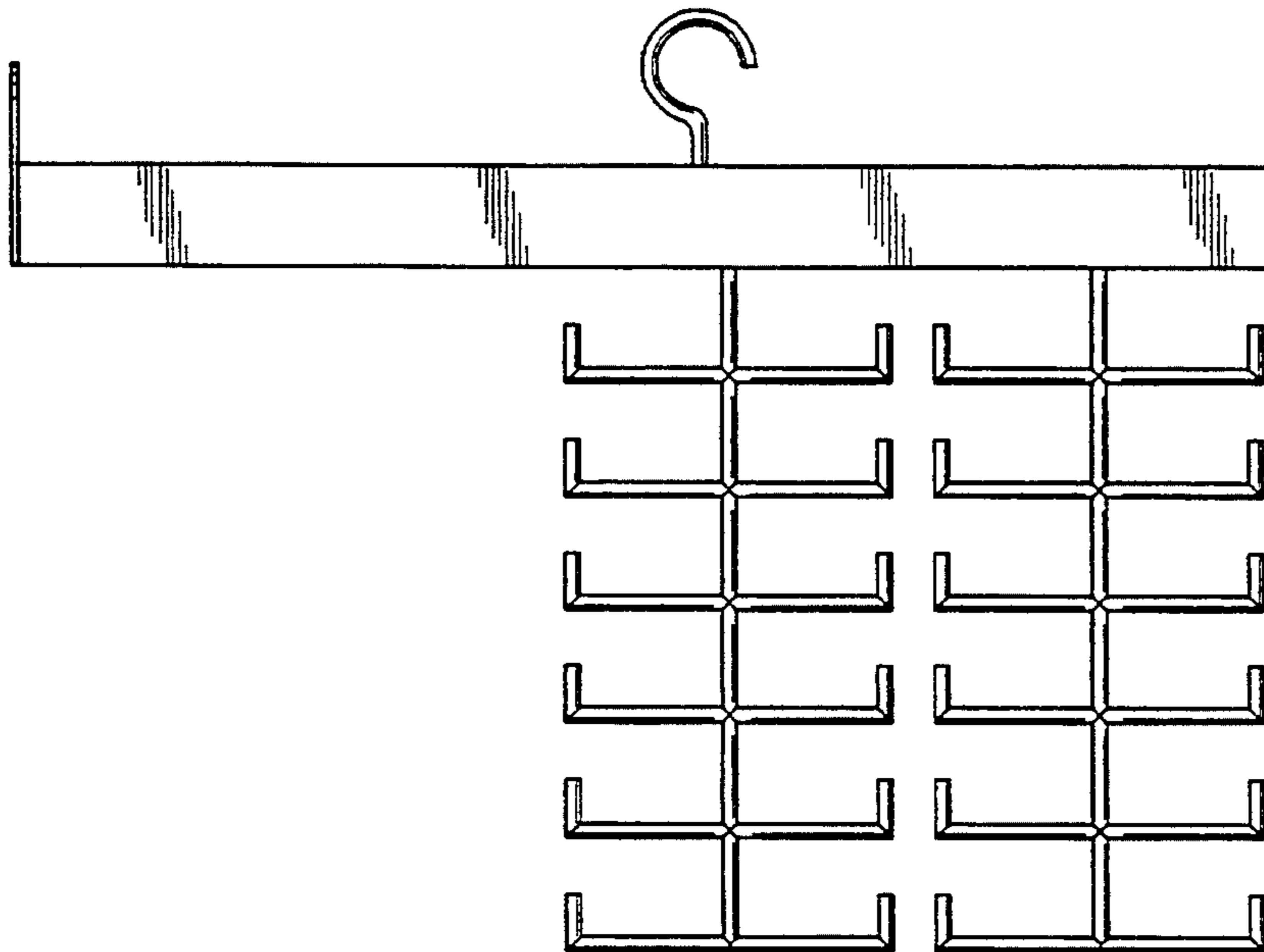

FIG. 2

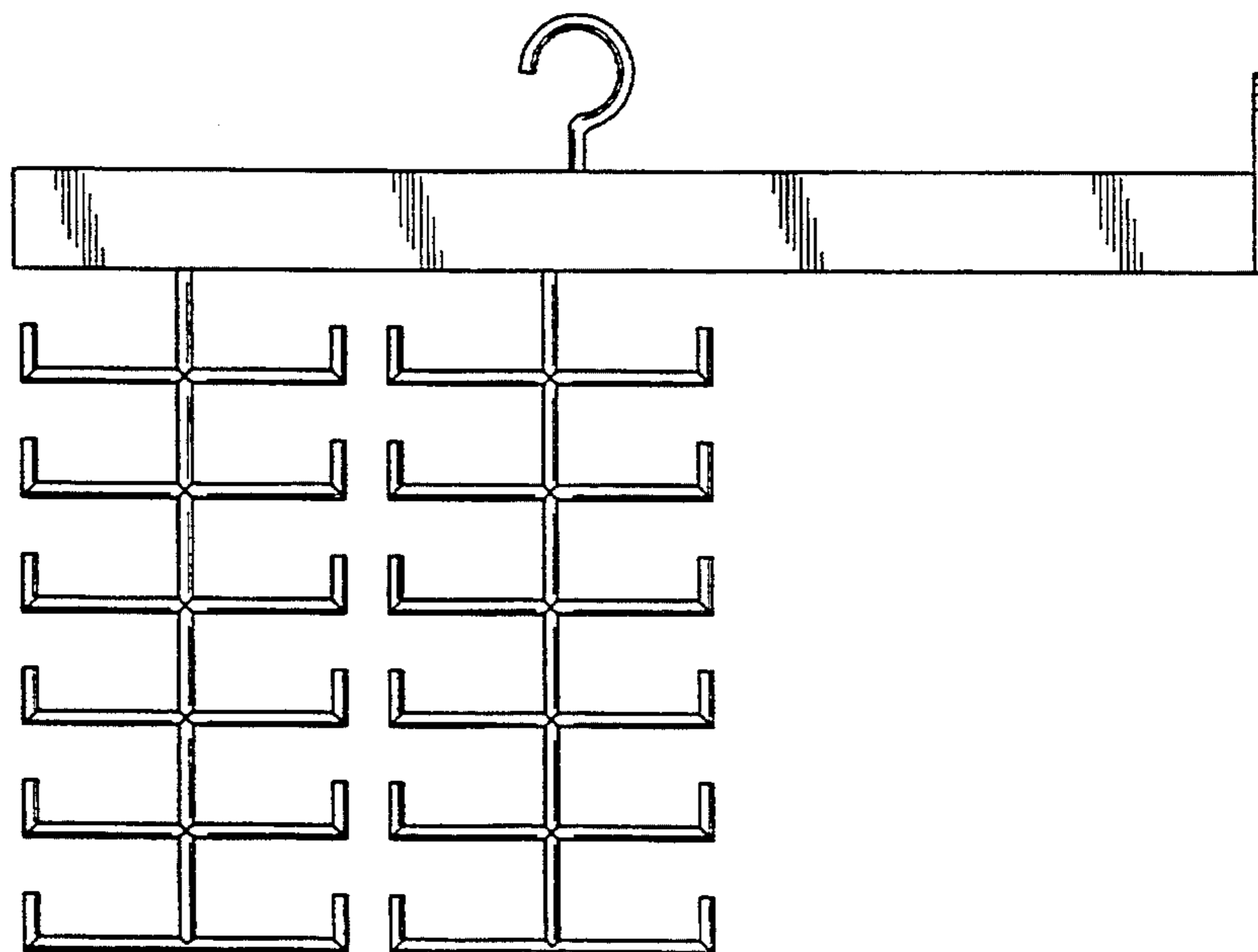

FIG. 3

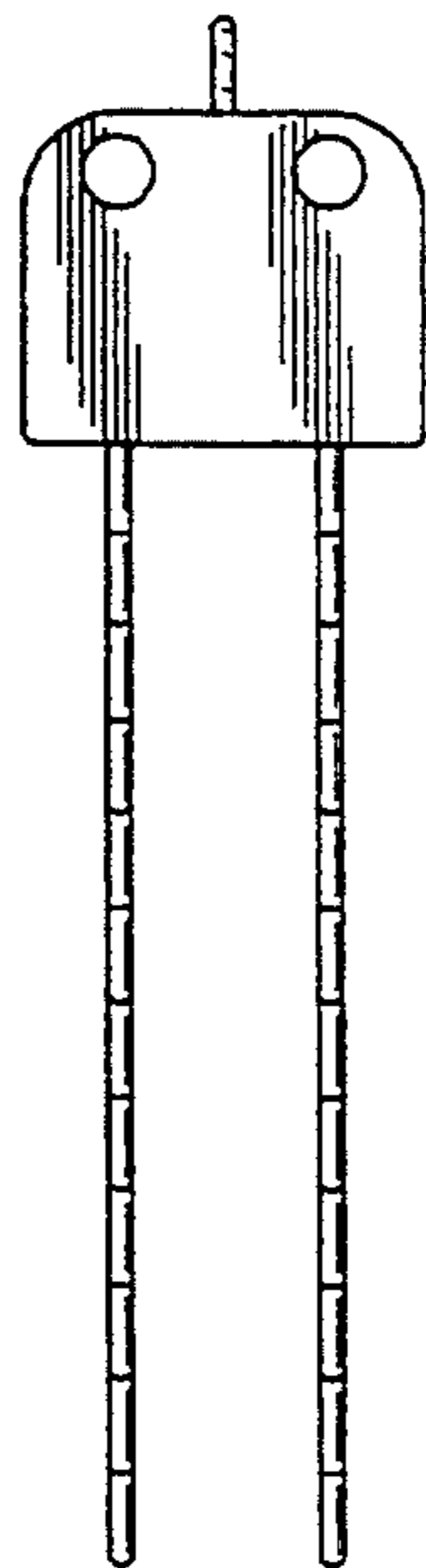

FIG. 4

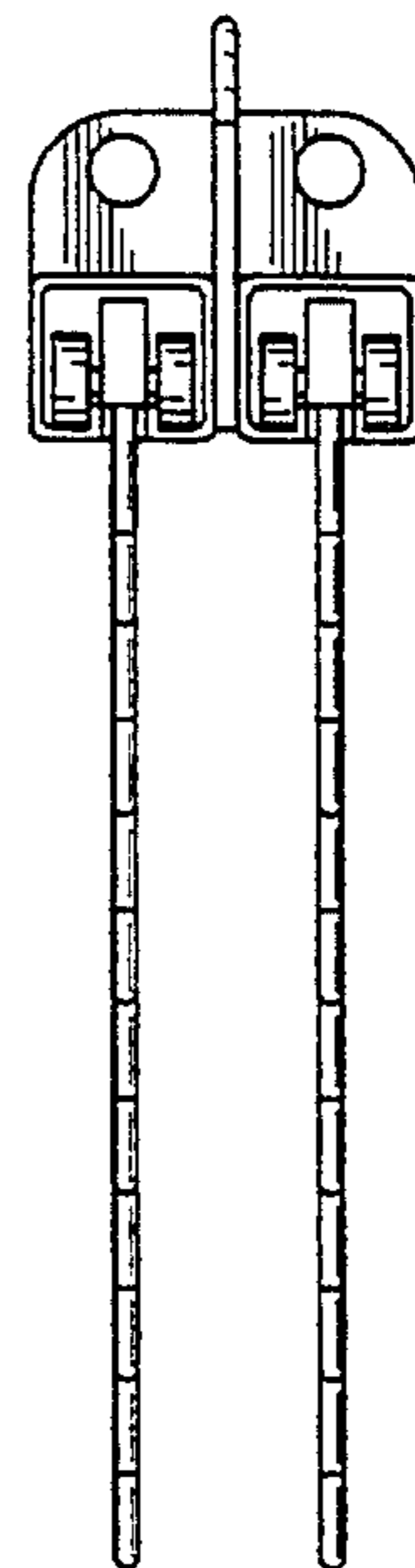

FIG. 5

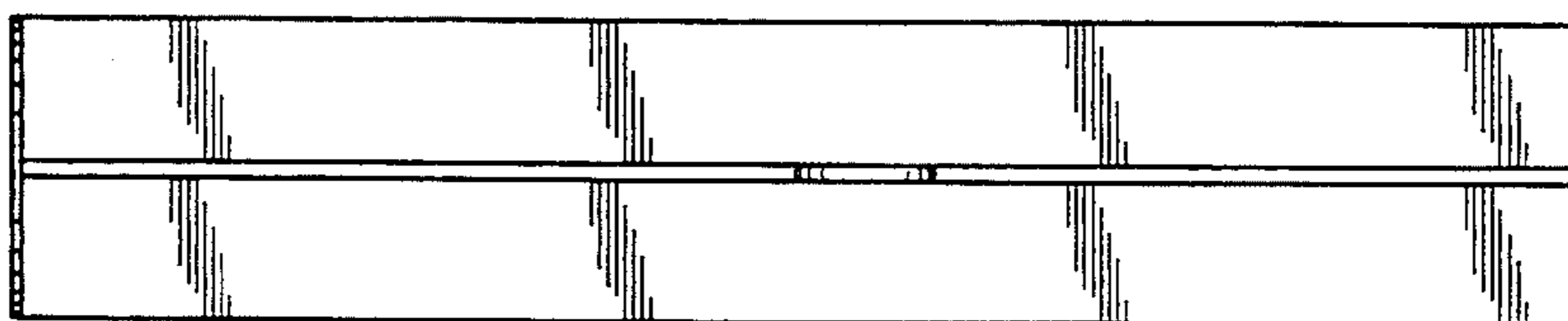

FIG. 6

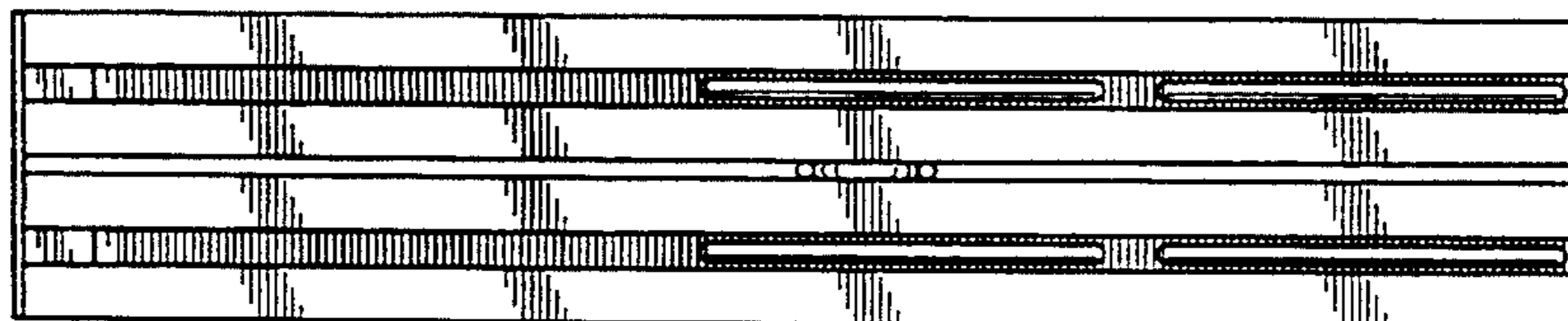

FIG. 7

