



US00D353830S

United States Patent [19]

[11] Patent Number: Des. 353,830

Peck

[45] Date of Patent: ** Dec. 27, 1994

[54] COPY MACHINE BOOK SUPPORT

[75] Inventor: Walter D. Peck, Portland, Oreg.

[73] Assignee: Book Support Systems, Inc.,
Portland, Oreg.

[**] Term: 14 Years

[21] Appl. No.: 911,958

[22] Filed: Jul. 10, 1992

[52] U.S. Cl. D18/40

[58] Field of Search D18/40, 45; 248/452,
248/441.1, 442.2, 445, 447, 453, 447.1;
281/45-47, 49, 50, 51; 355/72, 230, 231

[56] References Cited

U.S. PATENT DOCUMENTS

284,228	9/1883	Pickering	248/453
1,807,517	5/1931	Erlendson et al.	248/447.1 X
3,589,808	6/1971	Del Vecchio	355/72 X
3,603,554	9/1971	Dickinson	248/453
4,796,847	1/1989	Kayner	248/452 X
5,053,819	10/1991	Malyon et al.	355/230

Primary Examiner—Alan P. Douglas

Assistant Examiner—Caron D. Veynar
Attorney, Agent, or Firm—Salter & Michaelson

[57] CLAIM

The ornamental design for a copy machine book support, as shown.

DESCRIPTION

FIG. 1 is a perspective view of a copy machine book support showing my new design;
 FIG. 2 is a top plan view thereof;
 FIG. 3 is a front elevational view thereof;
 FIG. 4 is a bottom plan view thereof;
 FIG. 5 is a rear elevational view thereof;
 FIG. 6 is a left-side elevational view thereof;
 FIG. 7 is a right-side elevational view thereof;
 FIG. 8 is a perspective view of a second embodiment of my new design of FIGS. 1-7;
 FIG. 9 is a top plan view thereof;
 FIG. 10 is a front elevational view thereof;
 FIG. 11 is a bottom plan view thereof;
 FIG. 12 is a rear elevational view thereof;
 FIG. 13 is a left-side elevational view thereof; and,
 FIG. 14 is a right-side elevational view thereof.

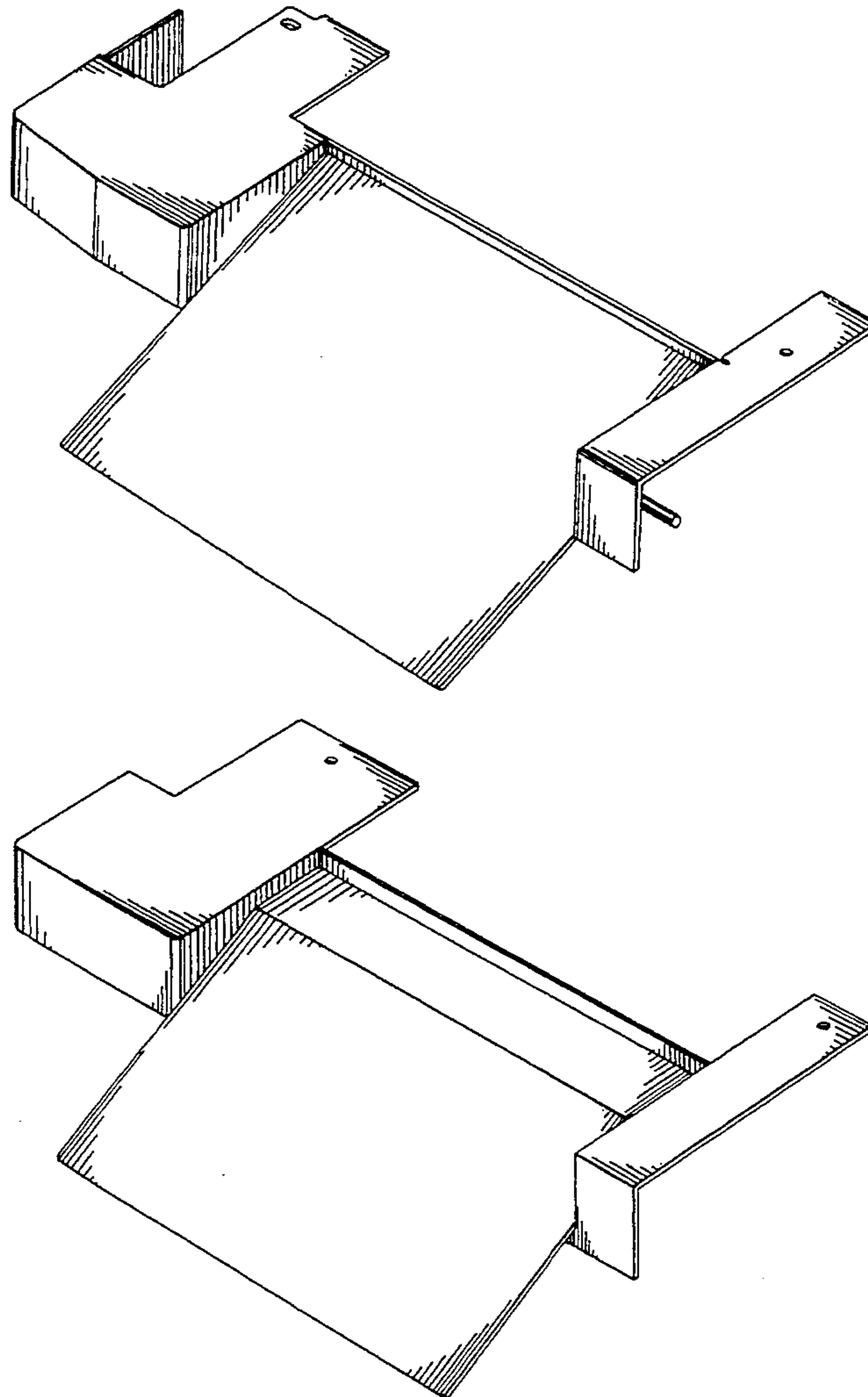

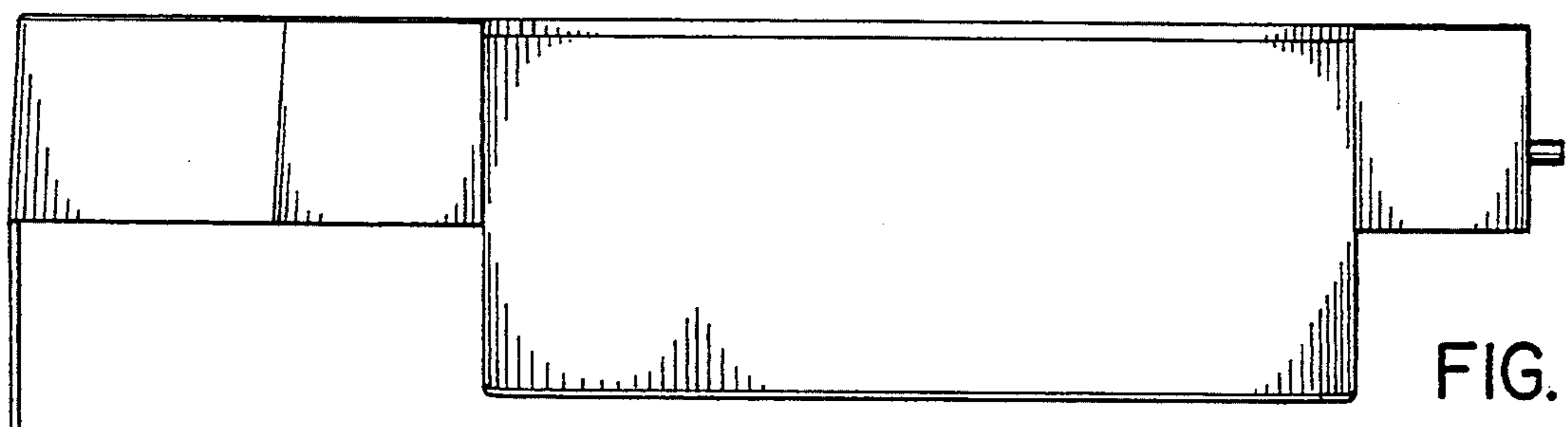
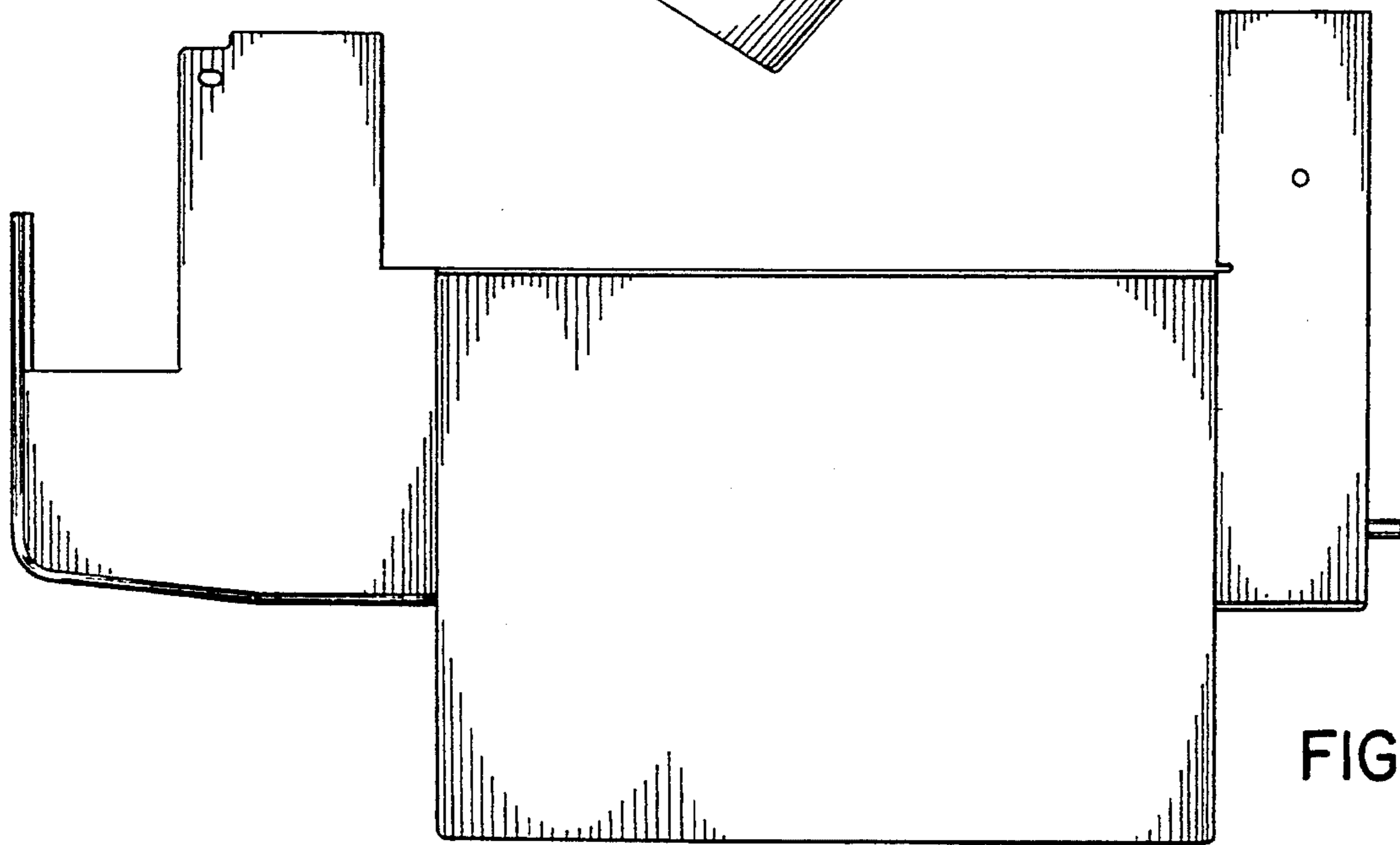
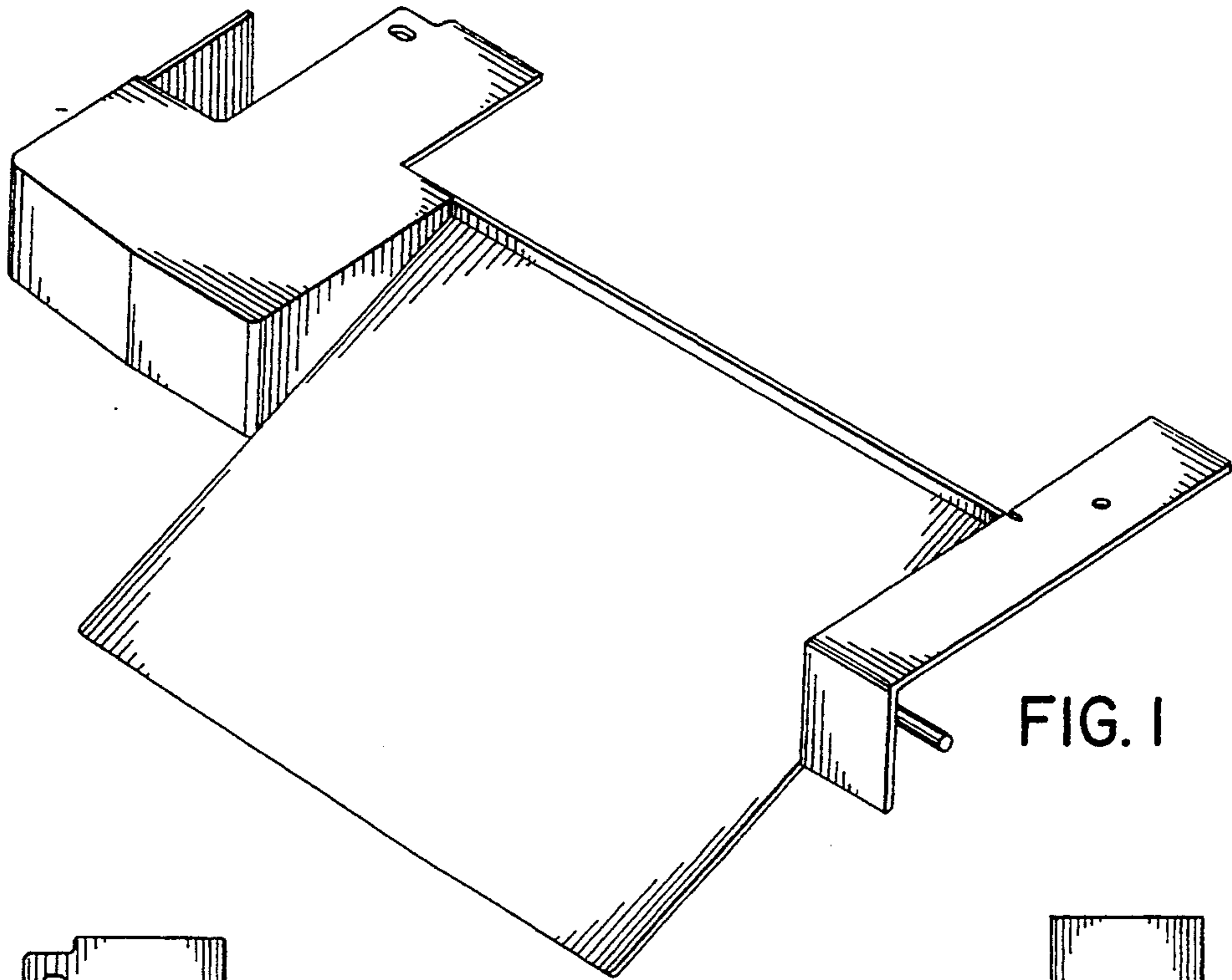

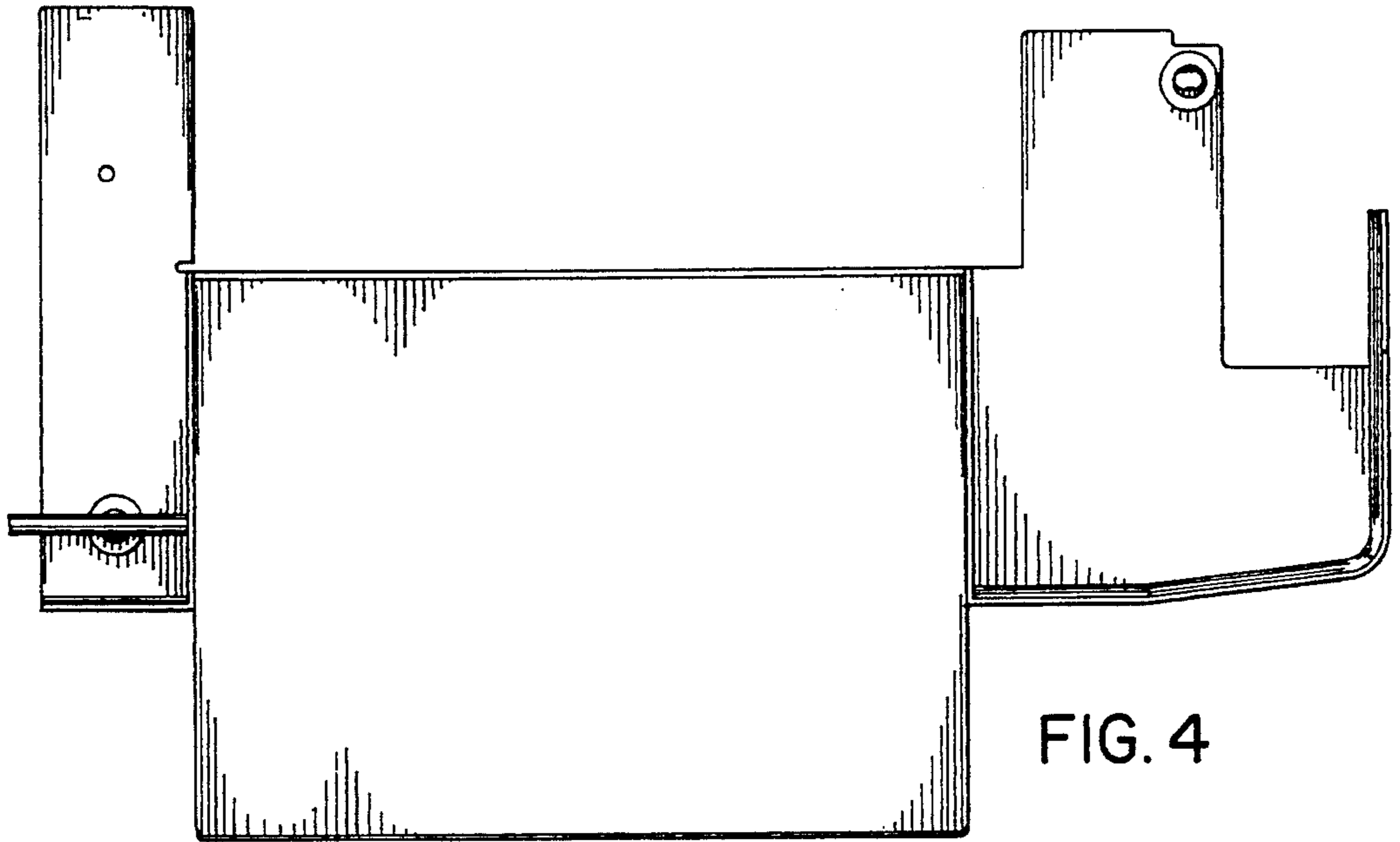

FIG. 4

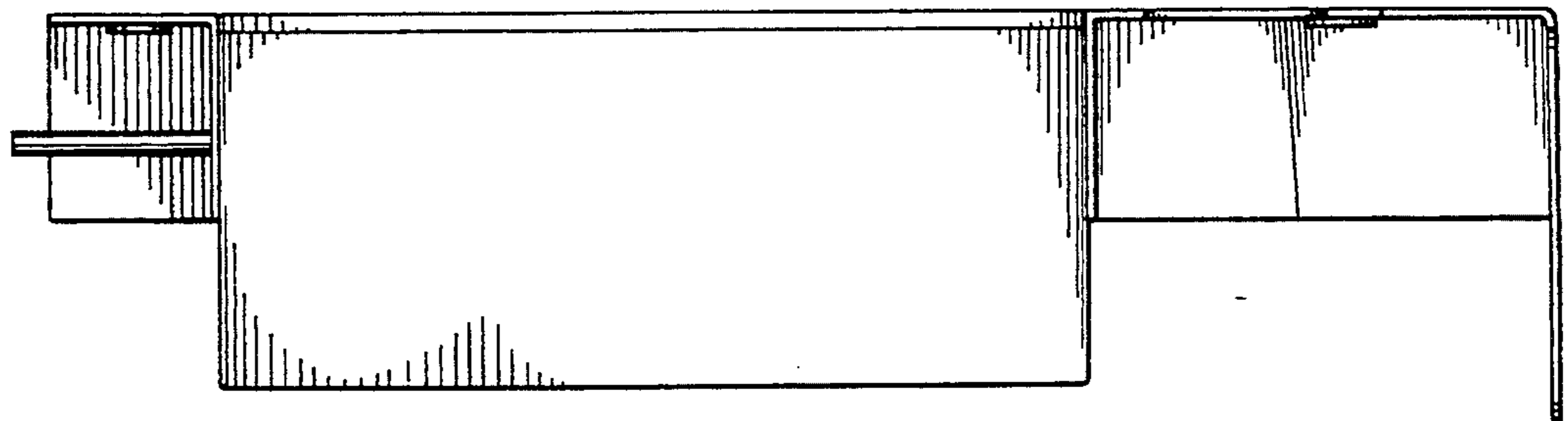

FIG. 5

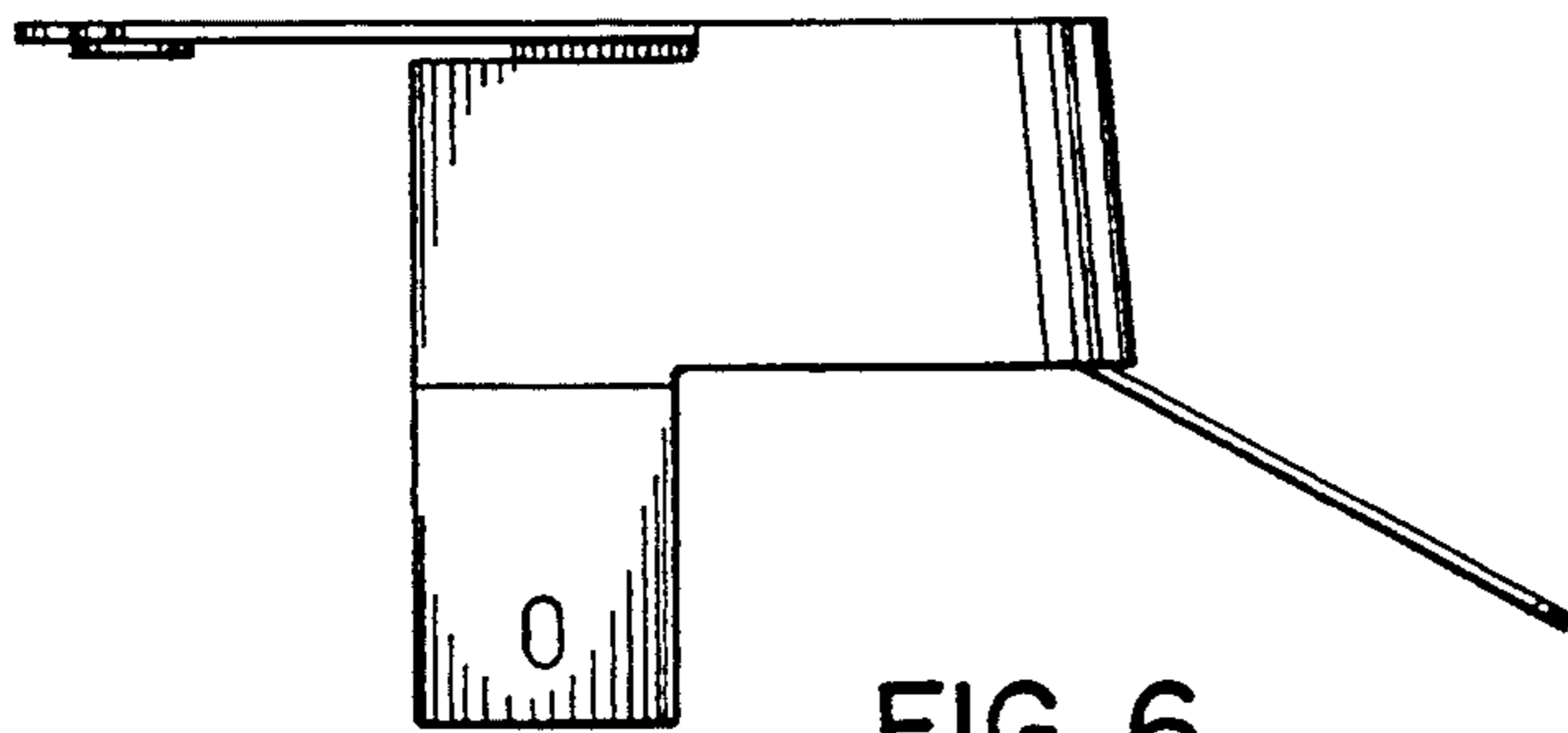

FIG. 6

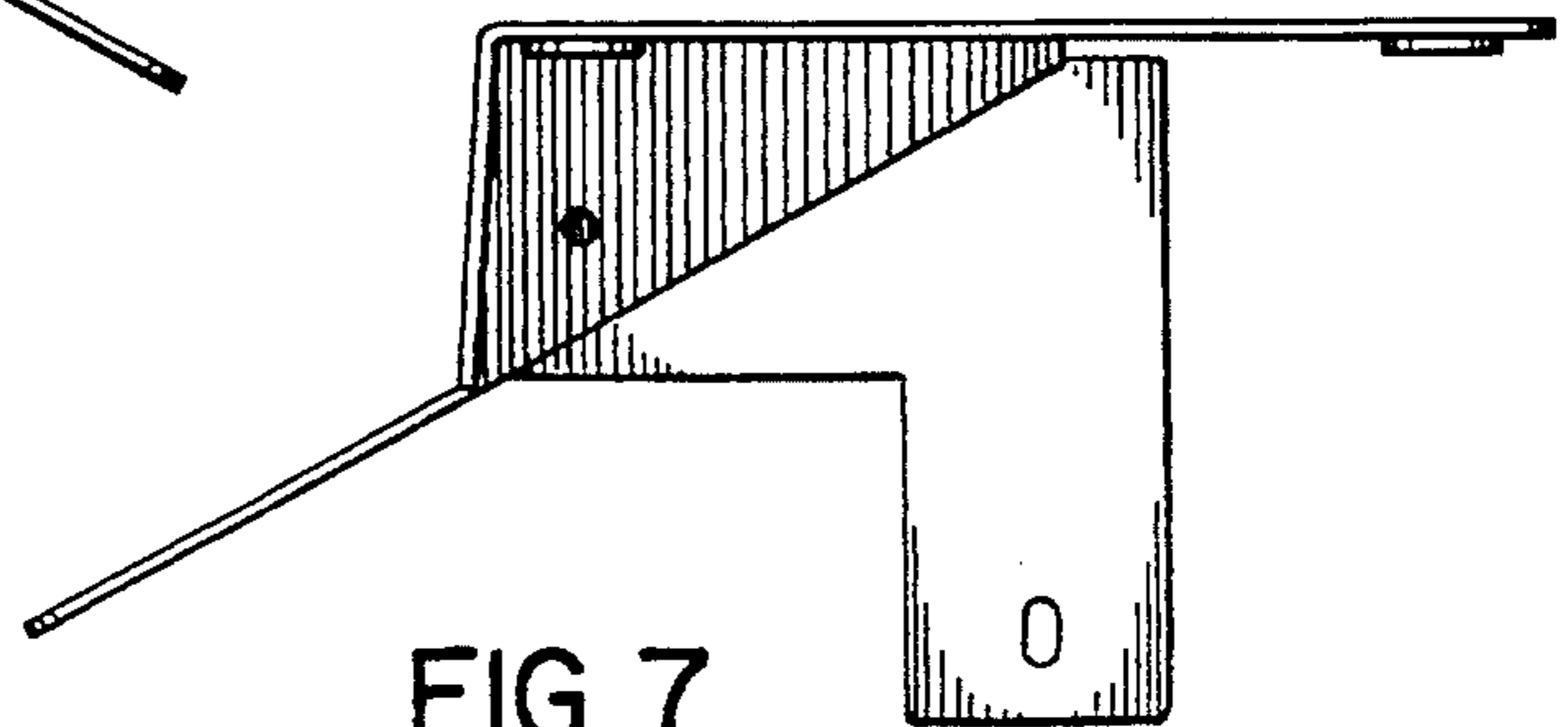

FIG. 7

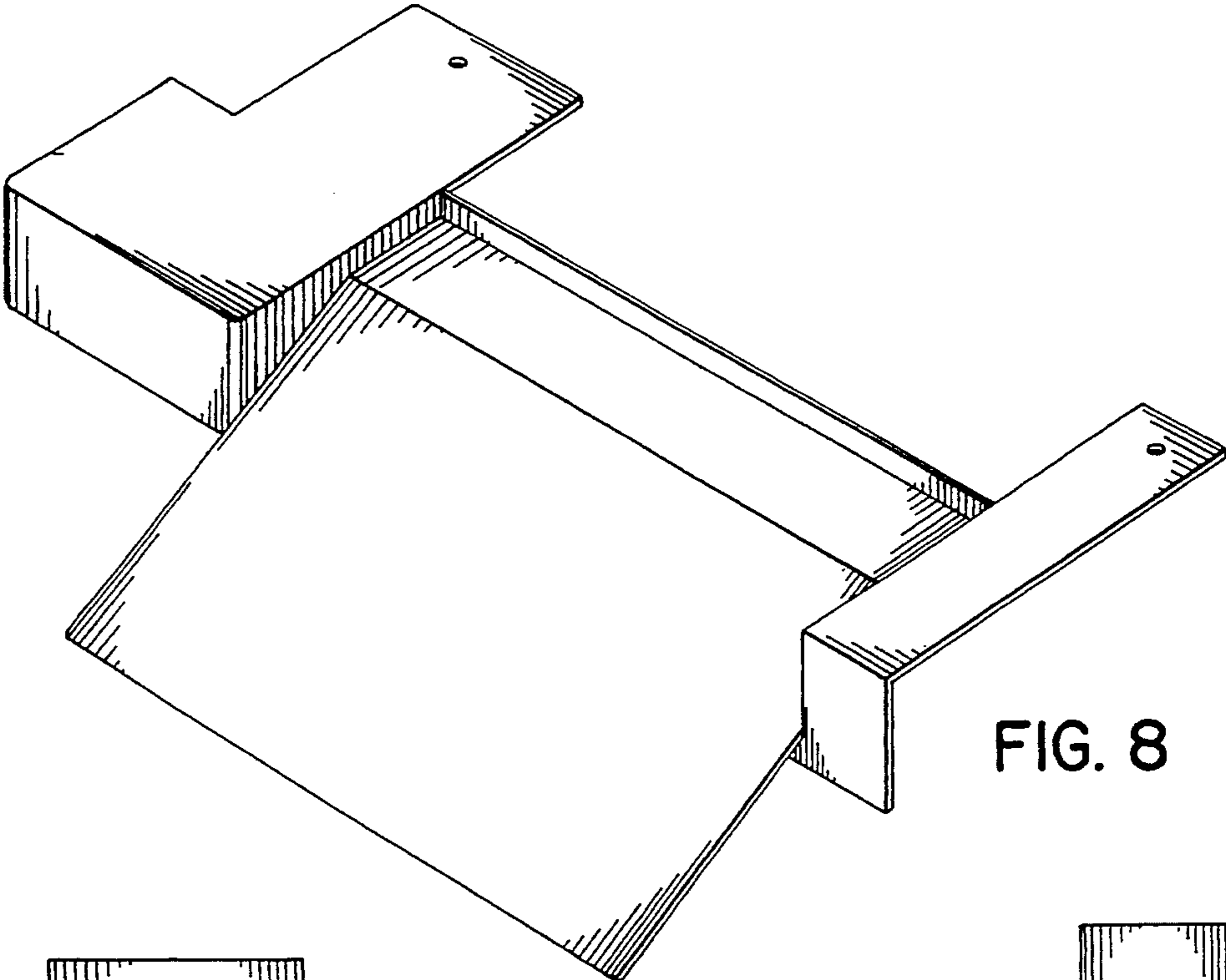

FIG. 8

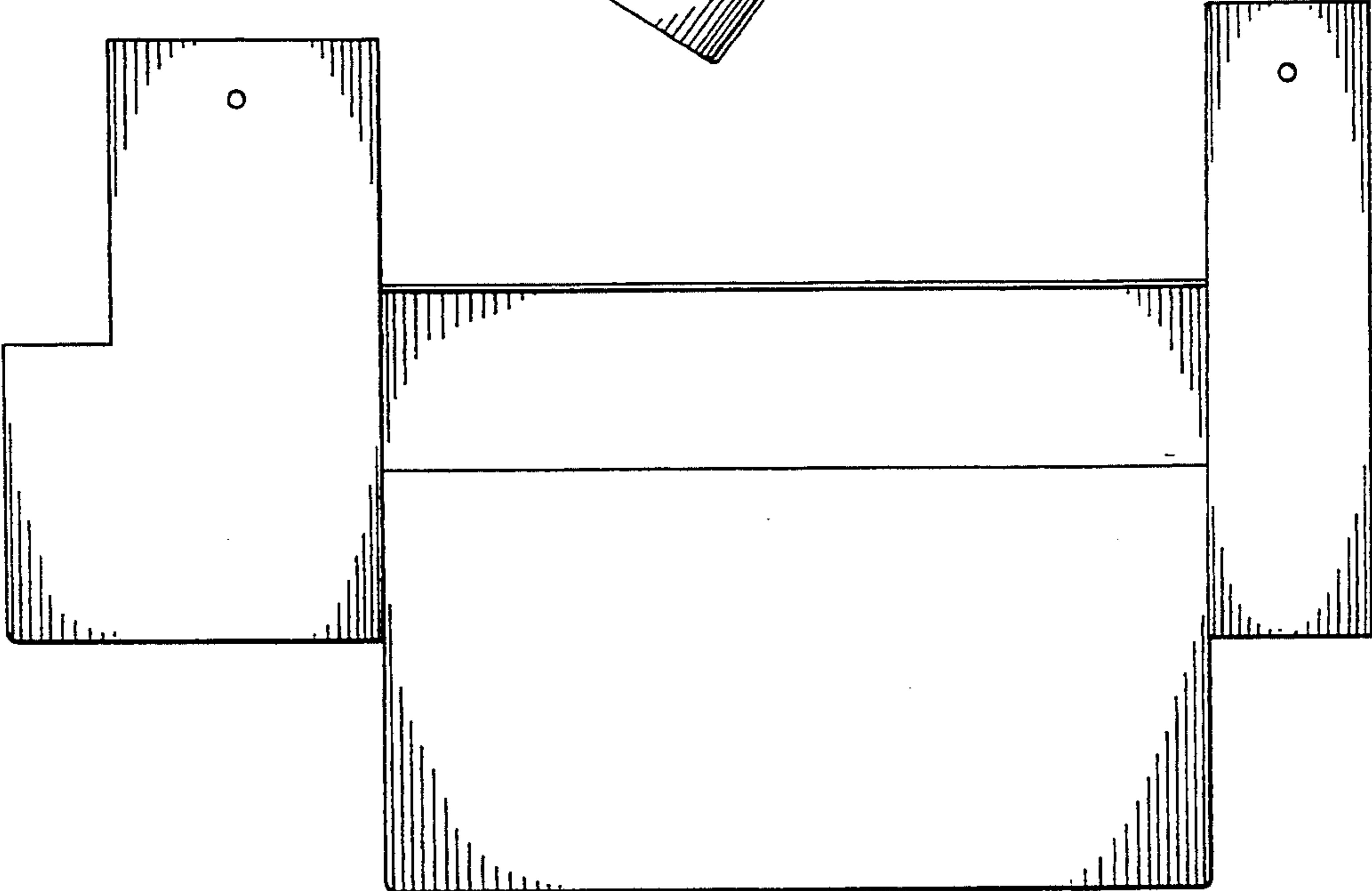

FIG. 9

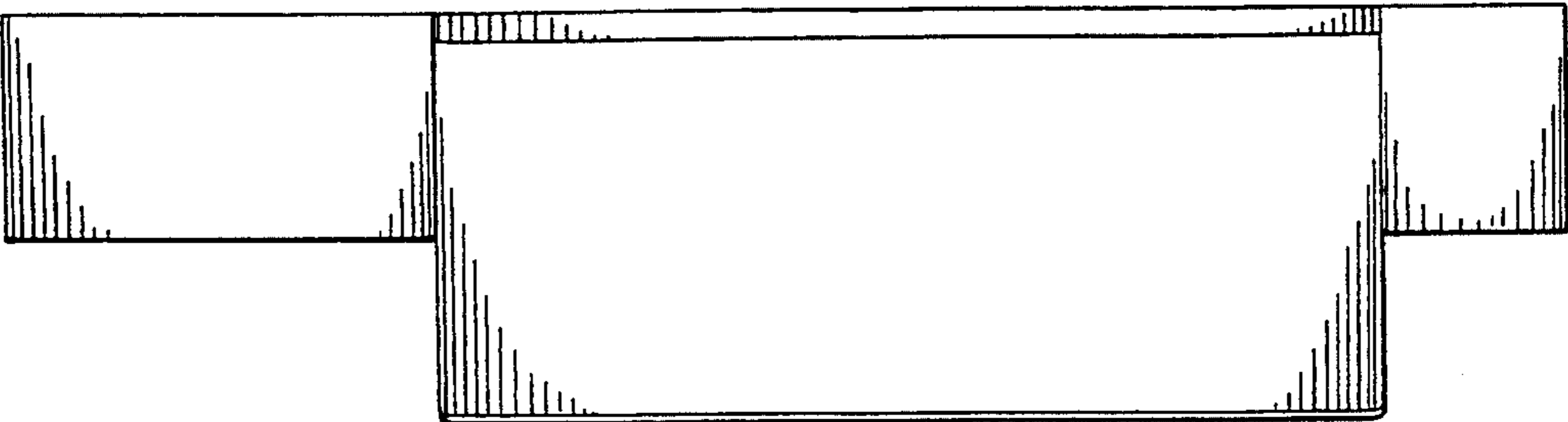

FIG. 10

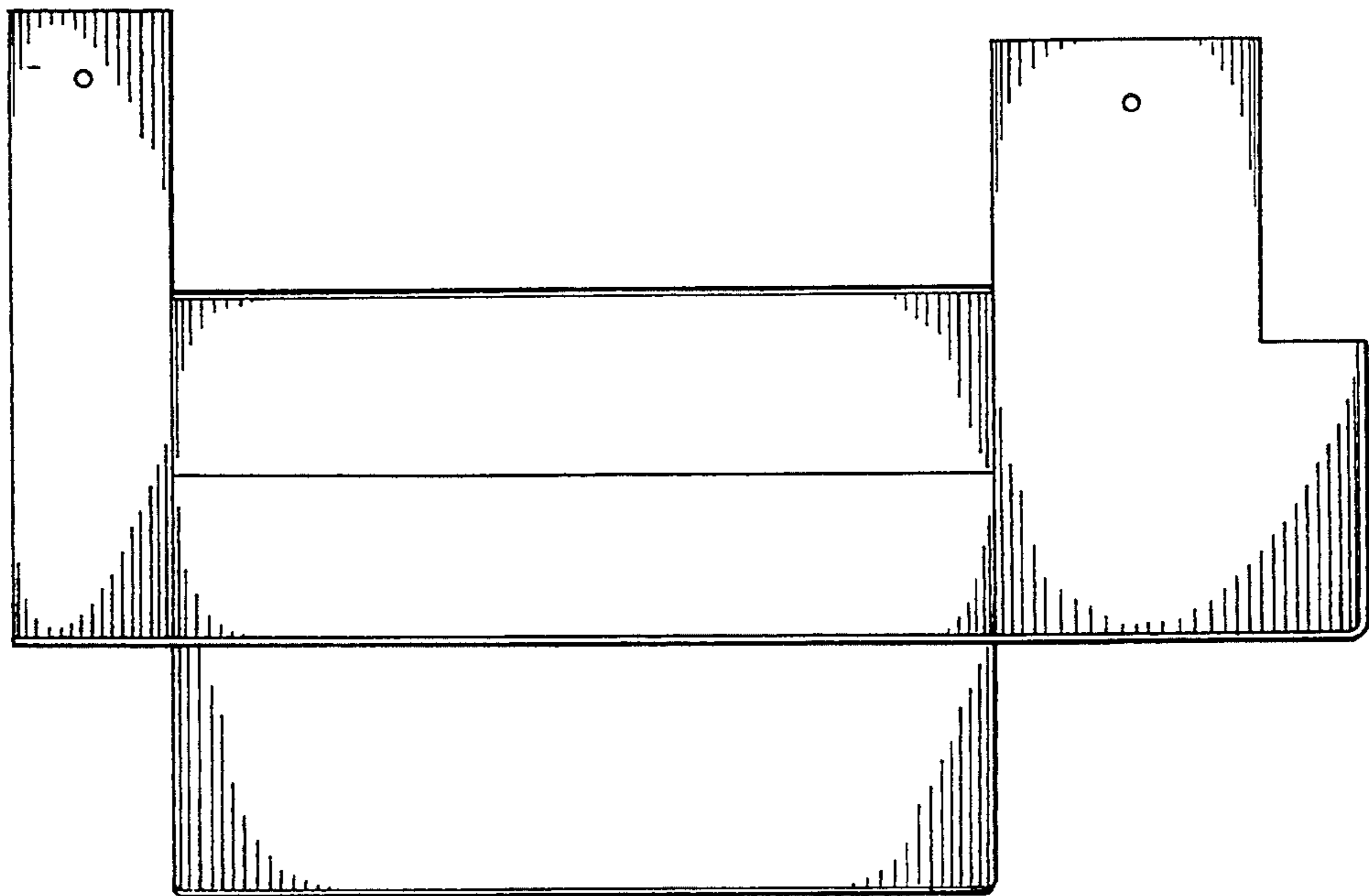

FIG. 11

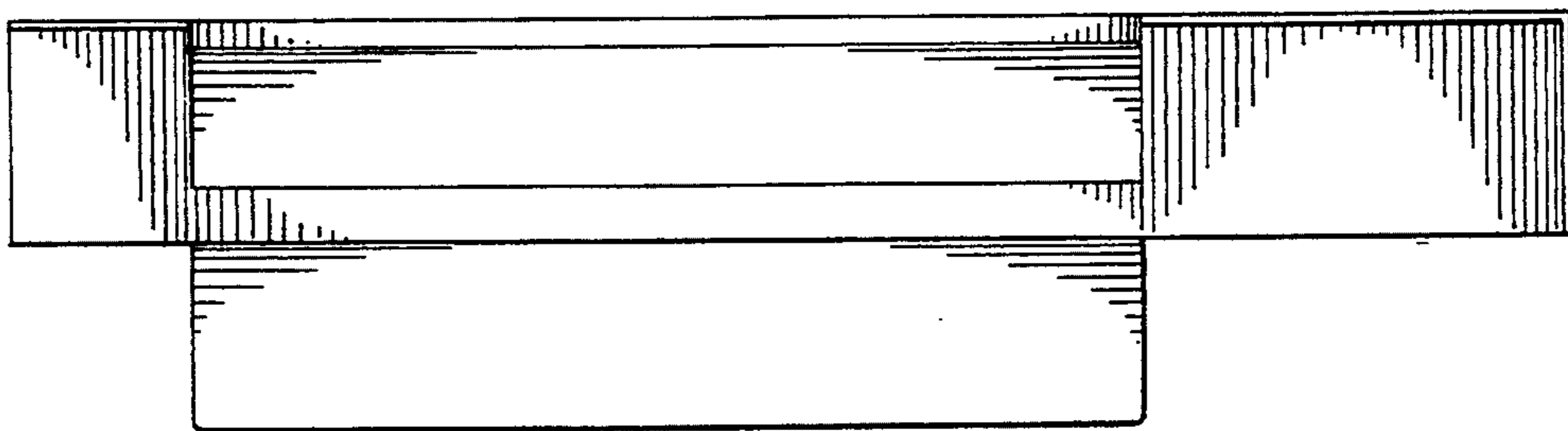

FIG. 12

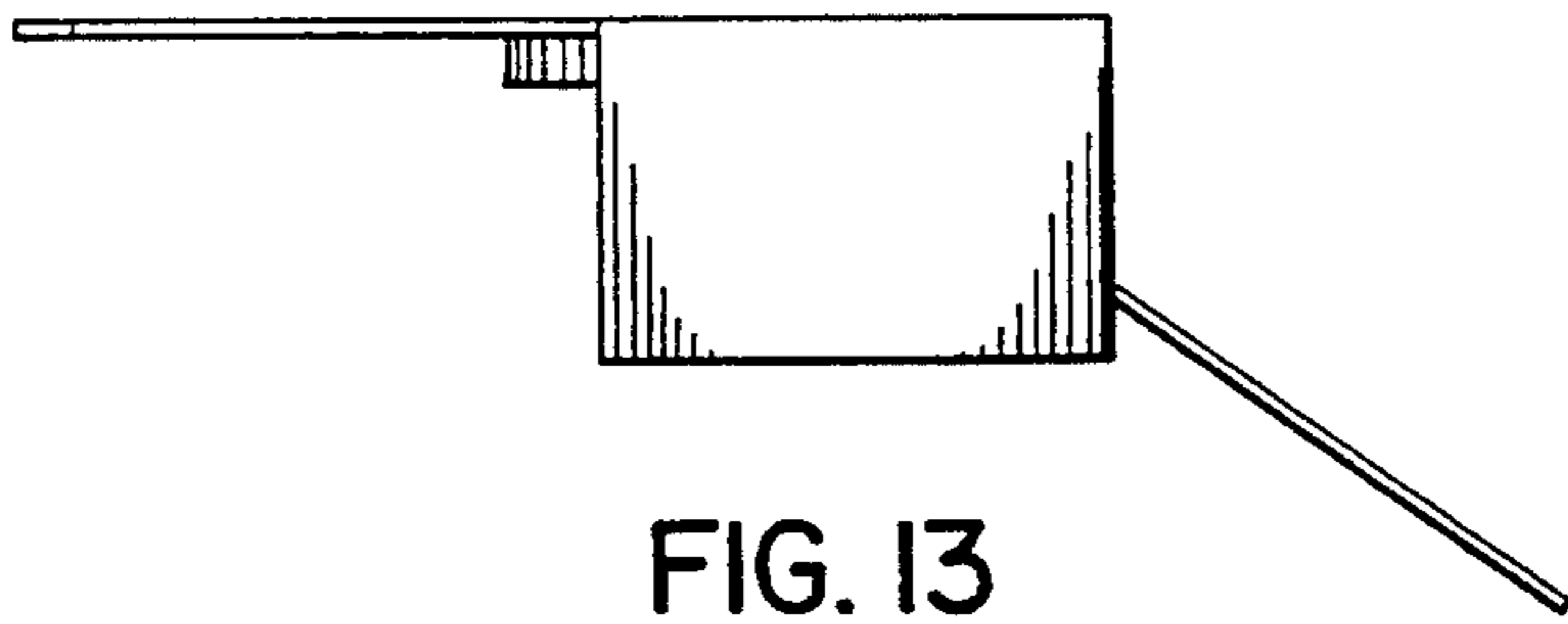

FIG. 13

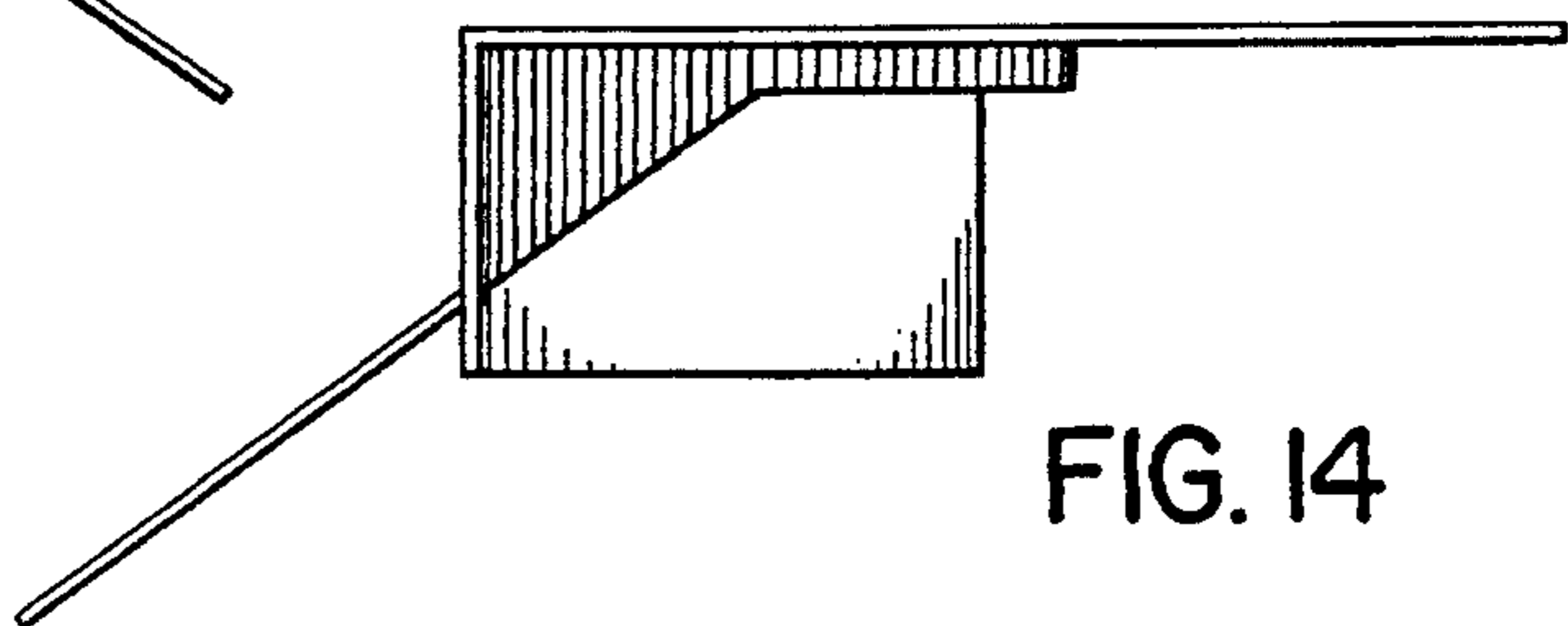

FIG. 14