



US00D353734S

United States Patent [19]

[11] Patent Number: **Des. 353,734**

Walls, Jr.

[45] Date of Patent: **** Dec. 27, 1994**

[54] **PORTABLE TOWEL RACK**

[76] Inventor: **Alvin R. Walls, Jr.**, 1686 NW. Spirit CT E, Silverdale, Wash. 98383

[**] Term: **14 Years**

[21] Appl. No.: **5,492**

[22] Filed: **Feb. 25, 1993**

[52] U.S. Cl. **D6/548; D6/513**

[58] Field of Search **D6/512-514, D6/566-567, 546, 548, 549; 211/86-87, 113, 119, 105.1, 123, 181**

D. 344,867 3/1994 Sutherland D6/513
 2,315,666 4/1943 Watral et al. 211/105.1 X

Primary Examiner—Brian N. Vinson
Attorney, Agent, or Firm—Hugh E. Smith

[57] CLAIM

The ornamental design for a portable towel rack, as shown and described.

DESCRIPTION

FIG. 1 is a front elevational view of a portable towel rack showing my new design;
 FIG. 2 is a rear elevational view thereof;
 FIG. 3 is a left side elevational view thereof;
 FIG. 4 is a right side elevational view thereof;
 FIG. 5 is a top plan view thereof;
 FIG. 6 is a bottom plan view thereof; and,
 FIG. 7 is an isometric view thereof.

[56] **References Cited**
U.S. PATENT DOCUMENTS

D. 165,553 12/1951 Schoor D6/572
 D. 276,388 11/1984 Miller et al. D6/566
 D. 327,598 7/1992 Emery D6/549

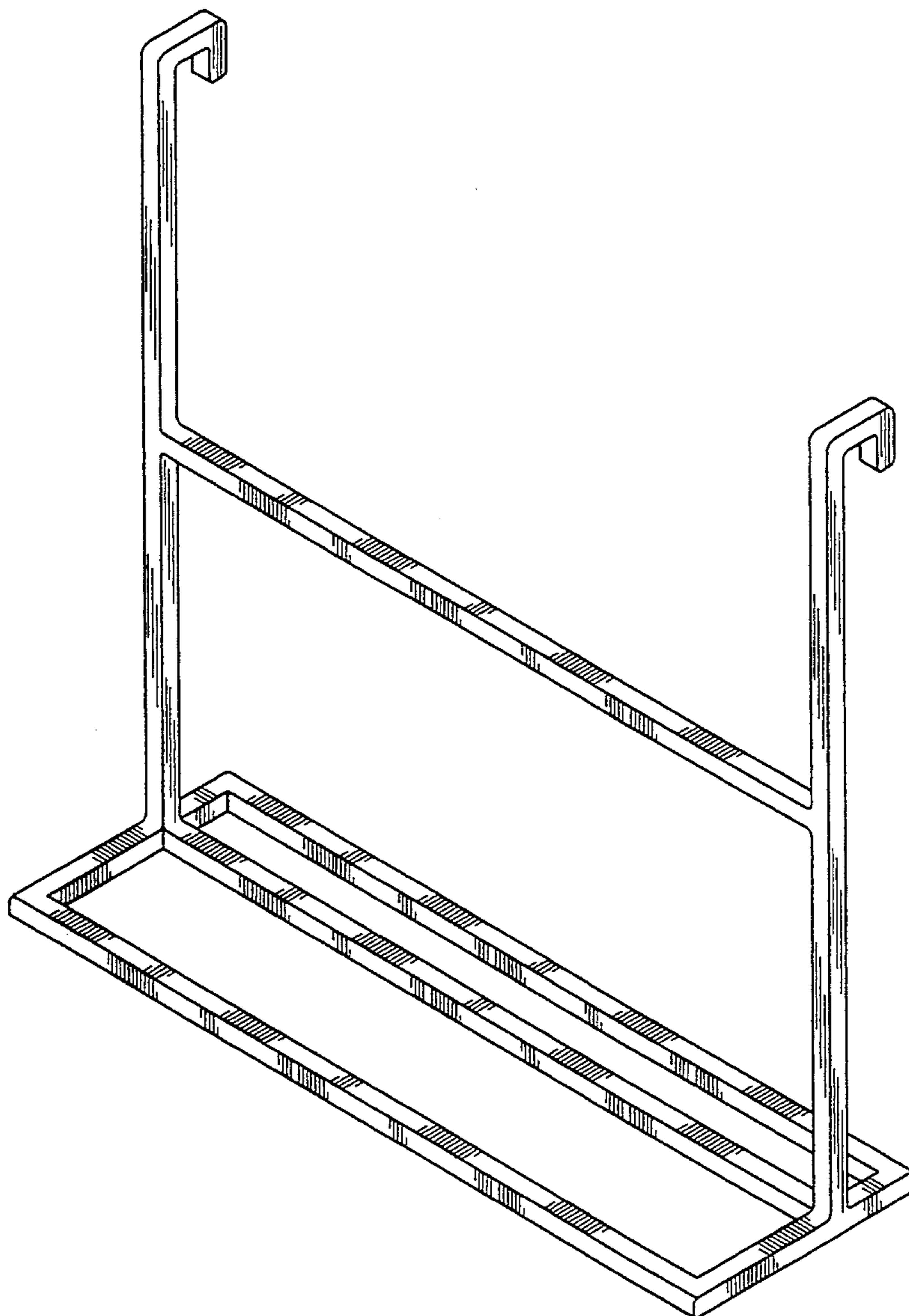

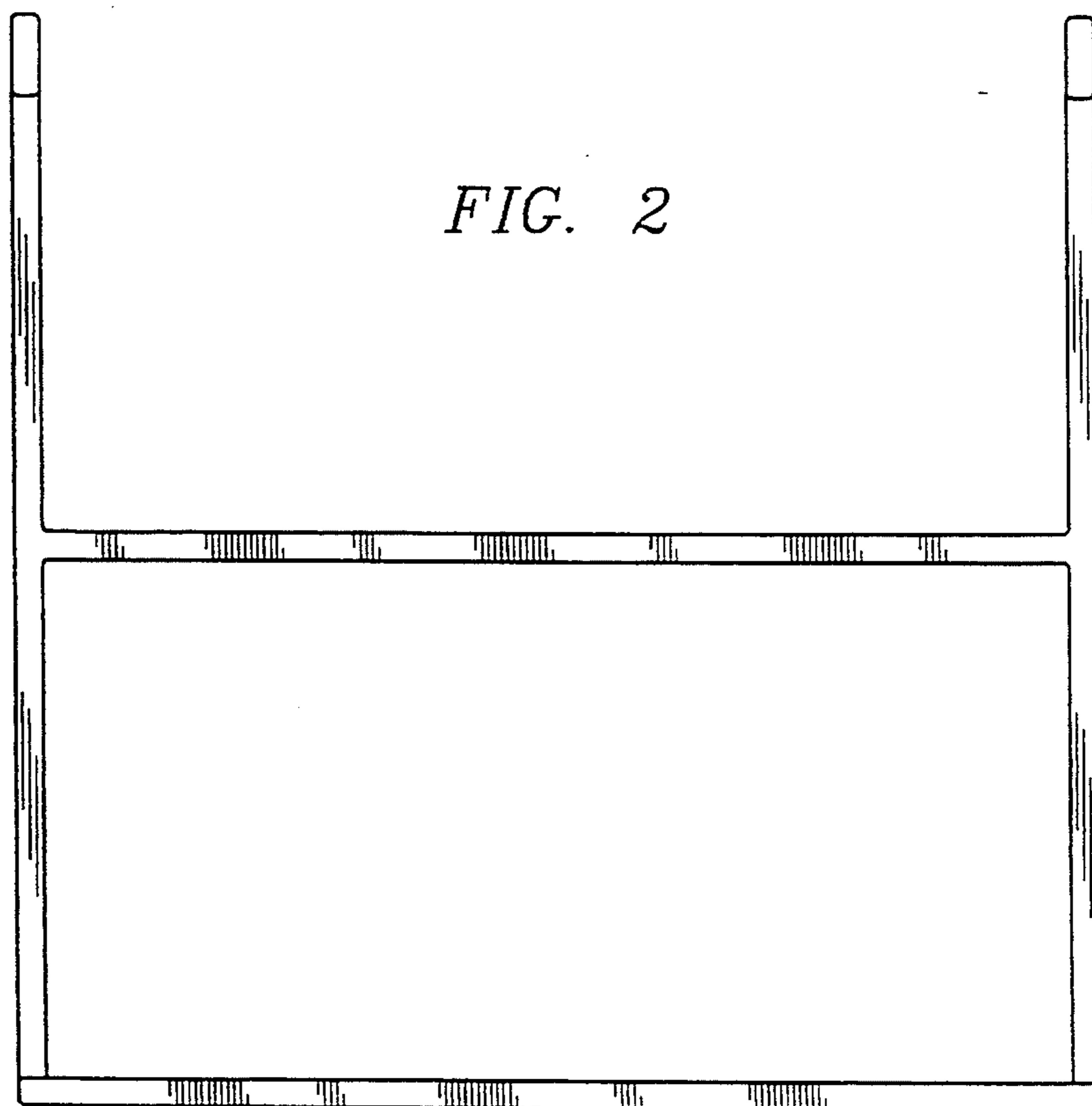
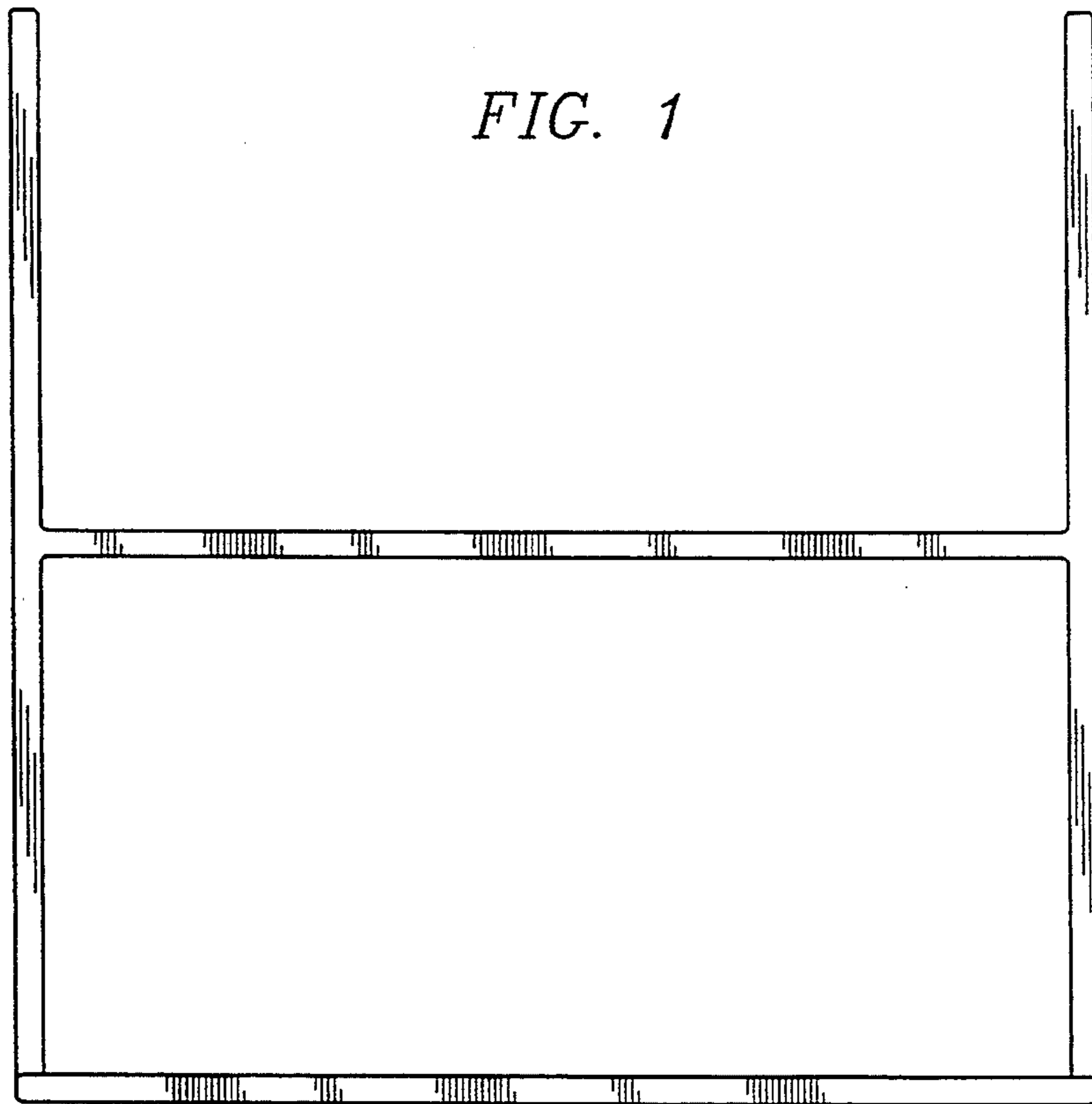

FIG. 3

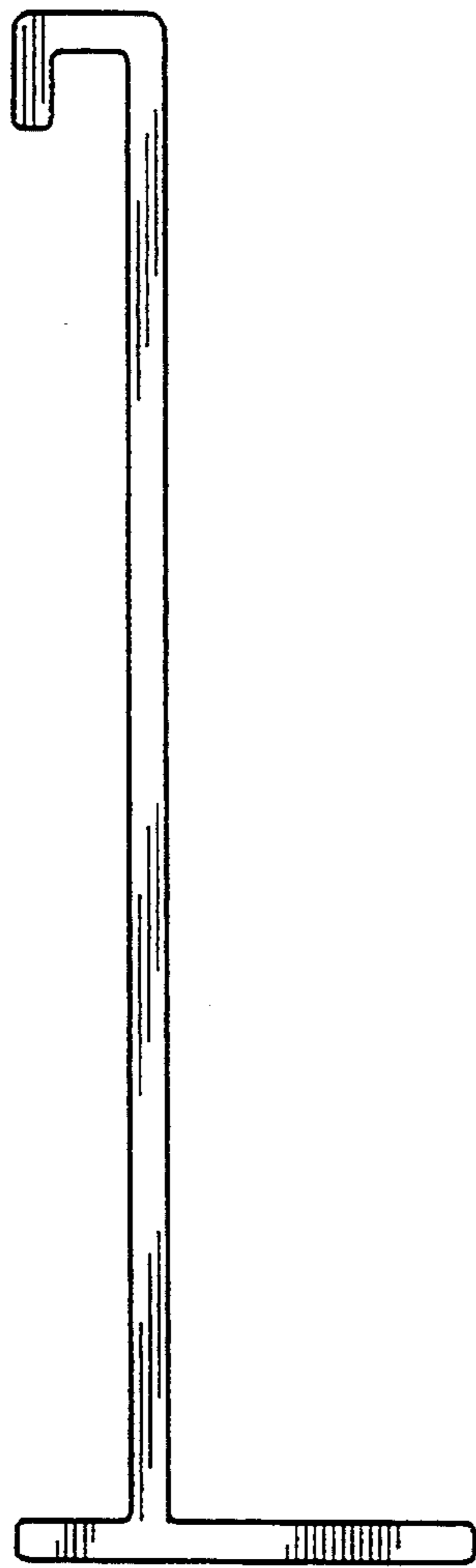

FIG. 4

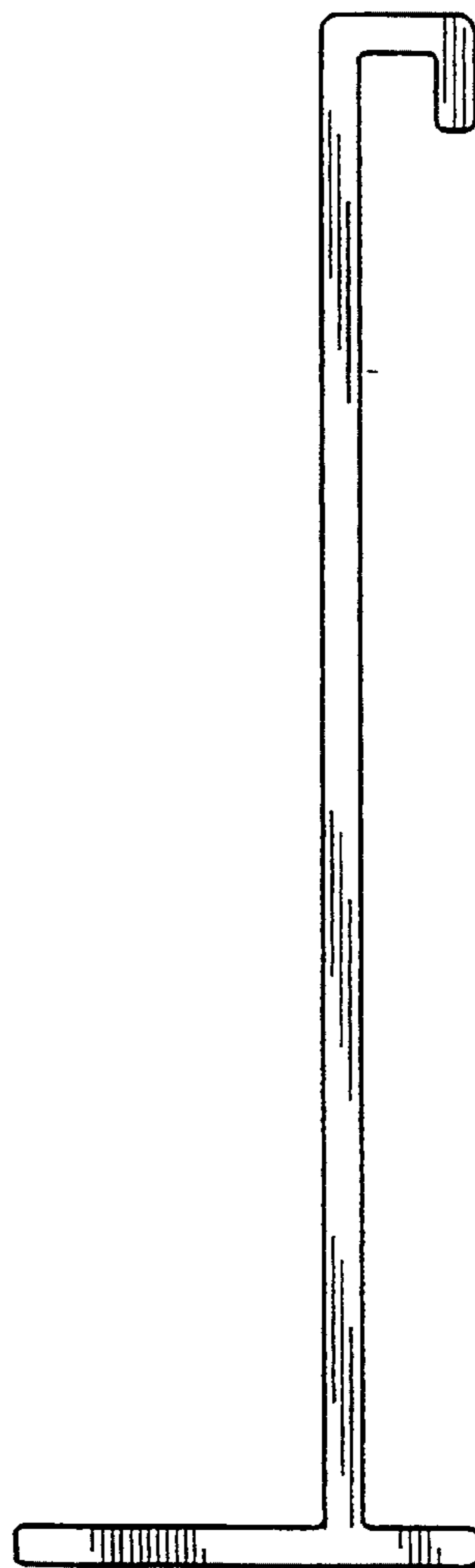

FIG. 5

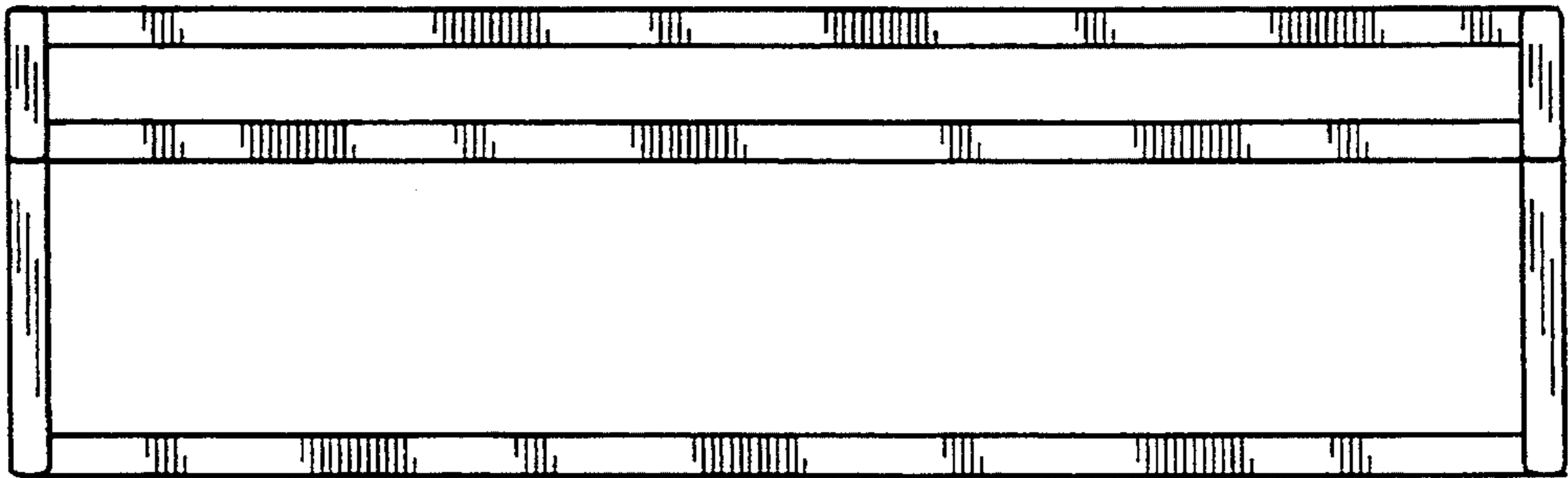

FIG. 6

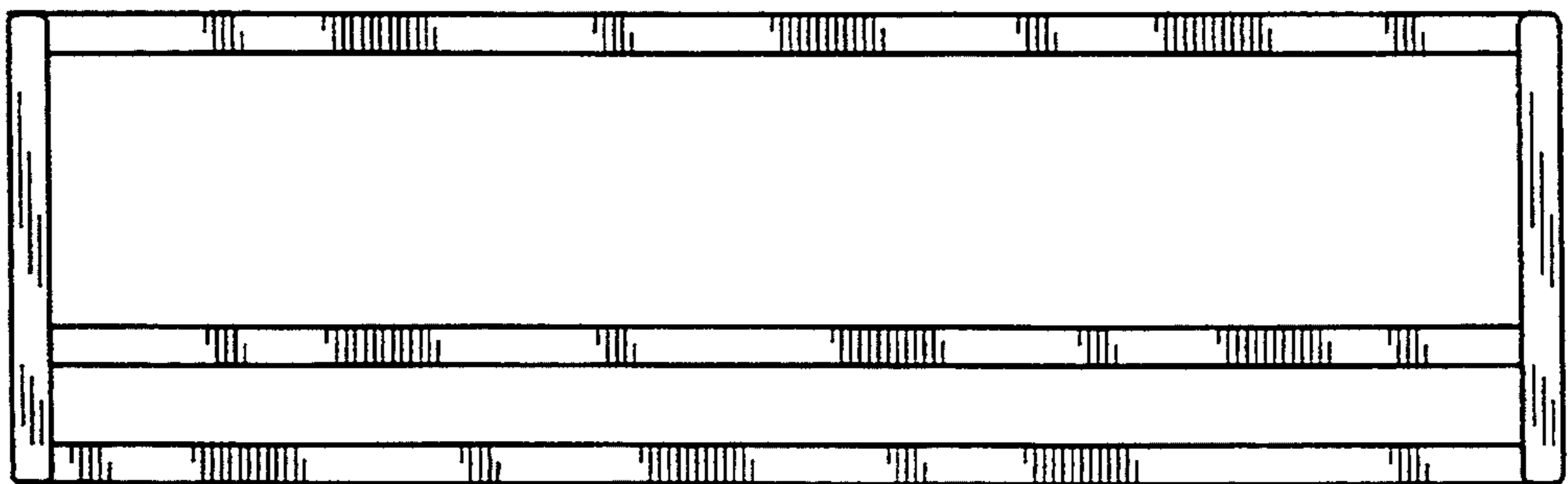

FIG. 7

