



US00D353688S

United States Patent [19] Wacker

[11] Patent Number: **Des. 353,688**
[45] Date of Patent: **** Dec. 20, 1994**

[54] **MAKE-UP KIT**

1,930,532 10/1933 Mitchell 220/DIG. 26 X

[75] Inventor: **Susan R. Wacker**, New York, N.Y.

OTHER PUBLICATIONS

[73] Assignee: **Elizabeth Arden Co., Division of Conopco, Inc.**, New York, N.Y.

"Hong Kong Enterprise" Nov. 1987; p. 135: item No. LP 288 at top.

[*] Notice: The portion of the term of this patent subsequent to Nov. 15, 2008 has been disclaimed.

Primary Examiner—Bernard Ansher
Assistant Examiner—C. Tuttle
Attorney, Agent, or Firm—Milton L. Honig

[**] Term: **14 Years**

[57] **CLAIM**

The ornamental design for a make-up kit, as shown and described.

[21] Appl. No.: **948,804**

[22] Filed: **Sep. 22, 1992**

DESCRIPTION

[52] U.S. Cl. **D28/82**

FIG. 1 is a perspective view from above showing my new design;

[58] Field of Search **D9/341, 420; 132/293-307, 314-318; 206/235, 581, 823; 220/DIG. 26; D28/76-84**

FIG. 2 is a side elevational view of my design;

FIG. 3 is a front elevational view of my design;

FIG. 4 is a top plan view of my design;

FIG. 5 is a bottom plan view of my design; and,

FIG. 6 is an exploded and internal view of the make-up kit but the pair of applicators form no part of the design.

The broken line showing of the pair of applicators each having circular ends separated by an elongated section is for illustrative purposes and forms no part of the claimed design.

[56] **References Cited**

U.S. PATENT DOCUMENTS

D. 158,174	4/1950	Busiel	D28/76
D. 215,766	10/1969	Dusek	D9/341 X
D. 277,419	1/1985	Schefer	D28/82
1,513,860	11/1924	Ruetter	220/DIG. 26 X
1,607,988	11/1926	Kendall	132/296

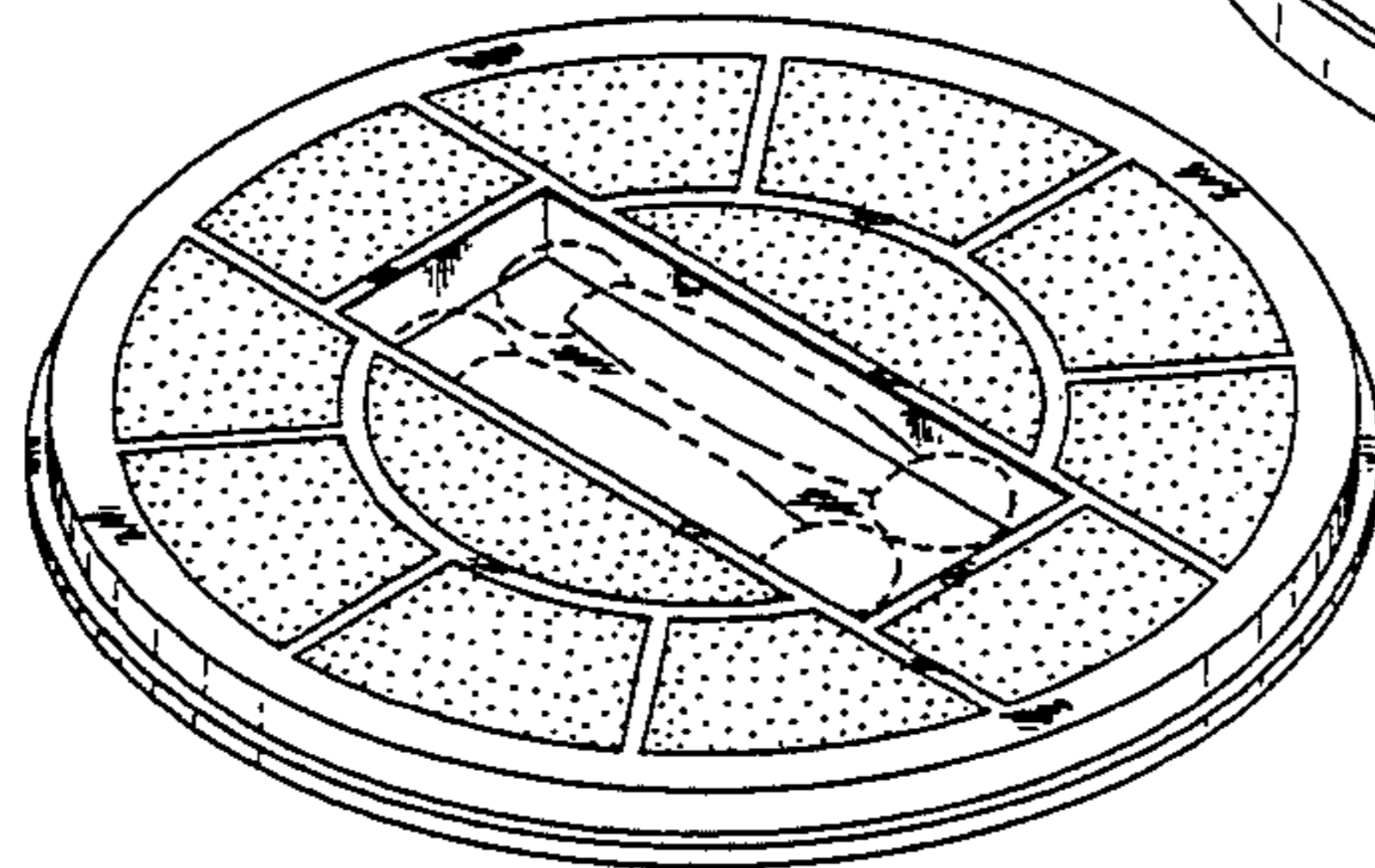
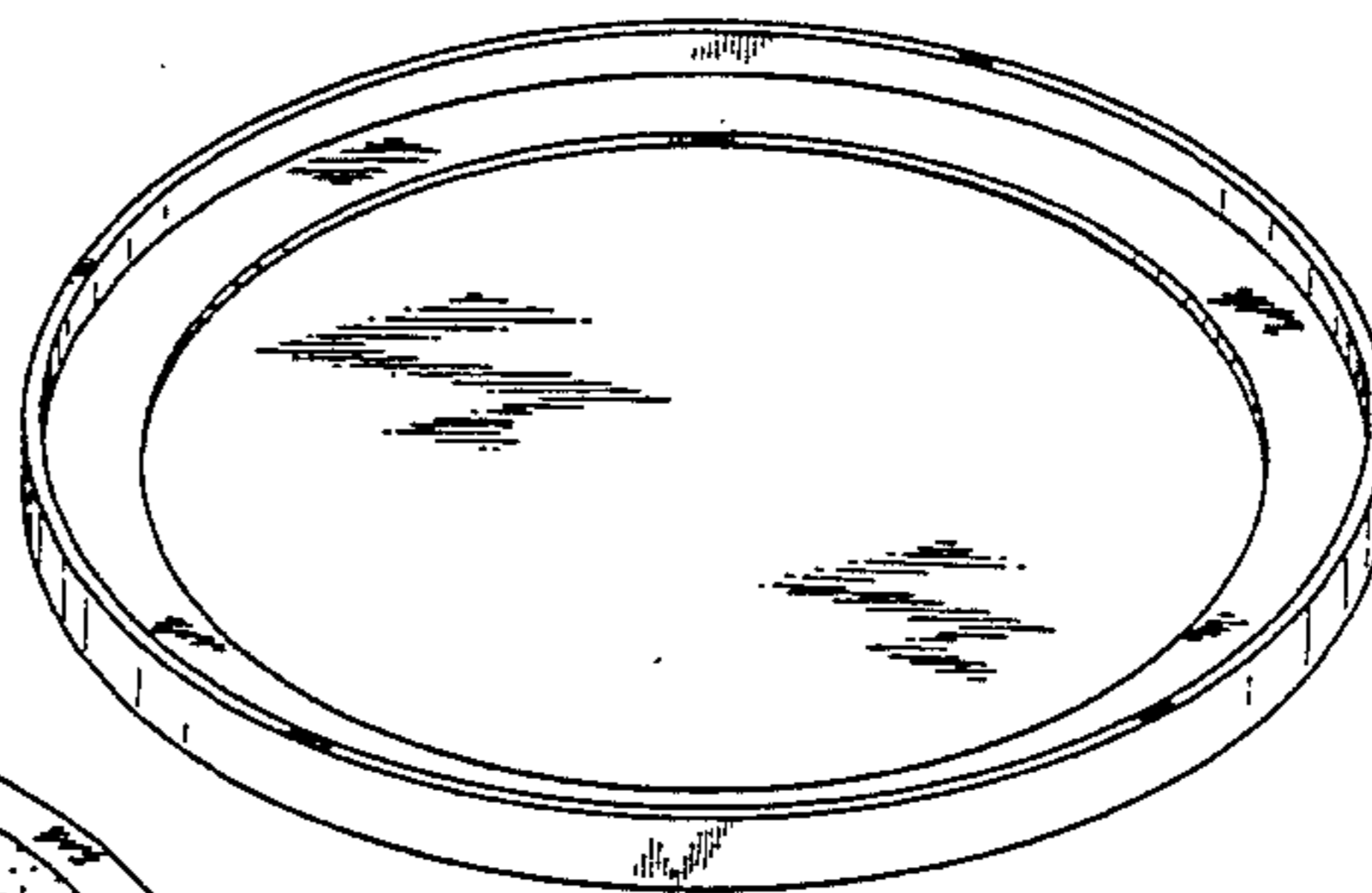
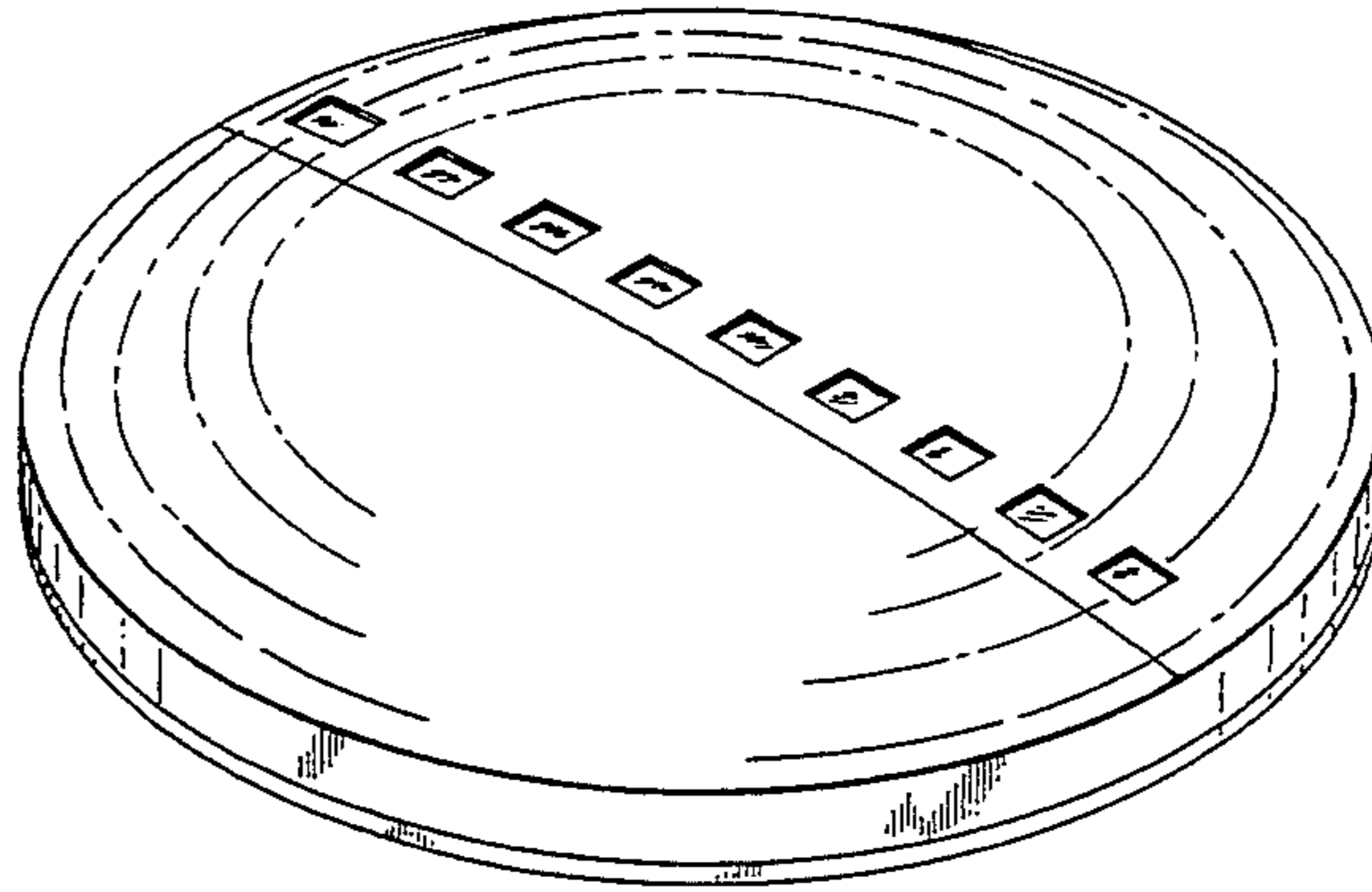

FIG. 1

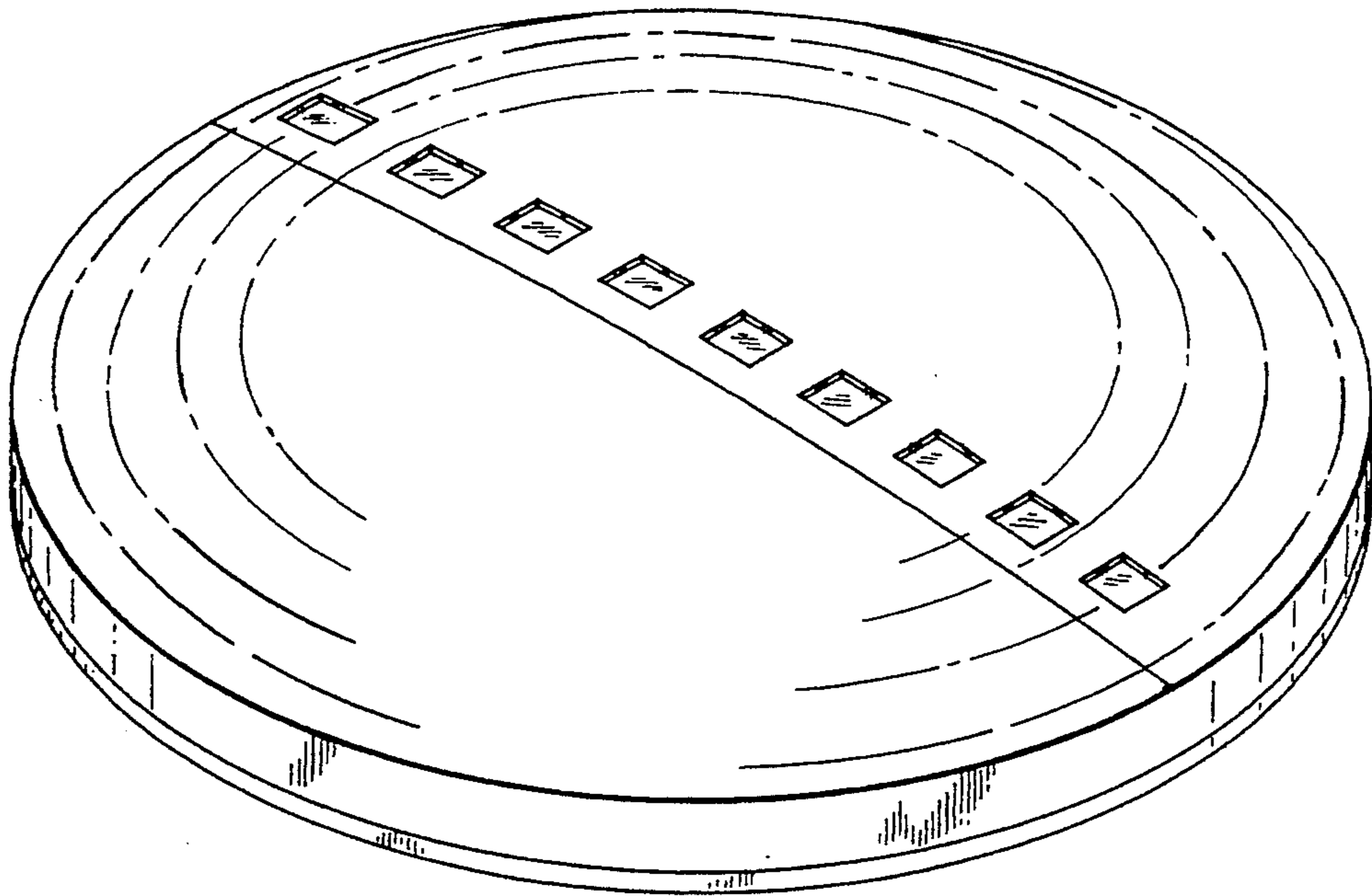

FIG. 2

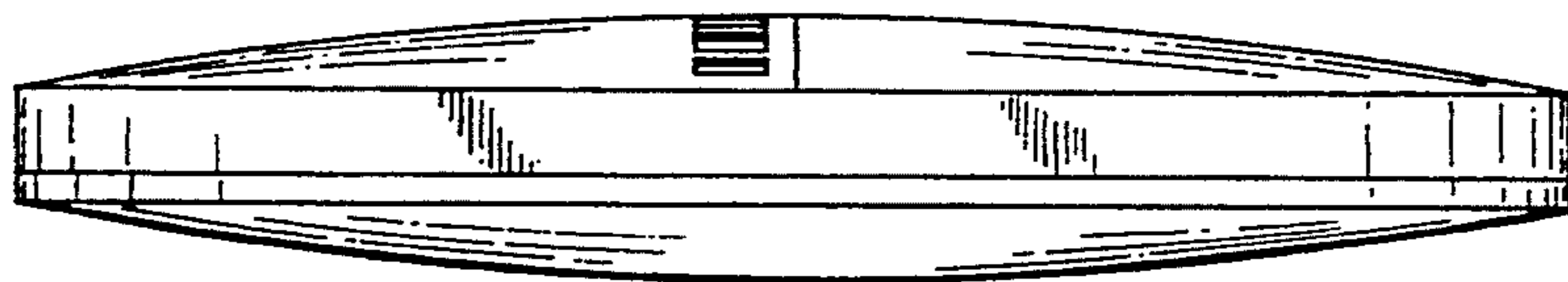

FIG. 3

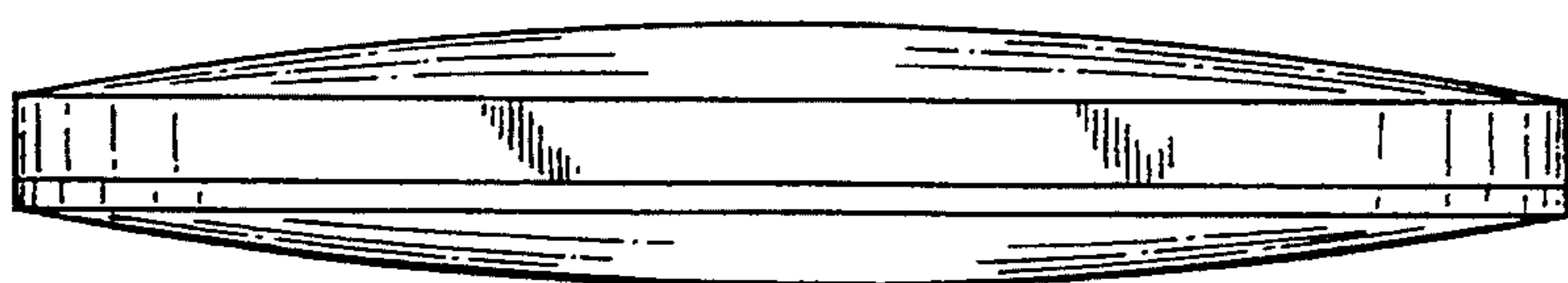

FIG. 4

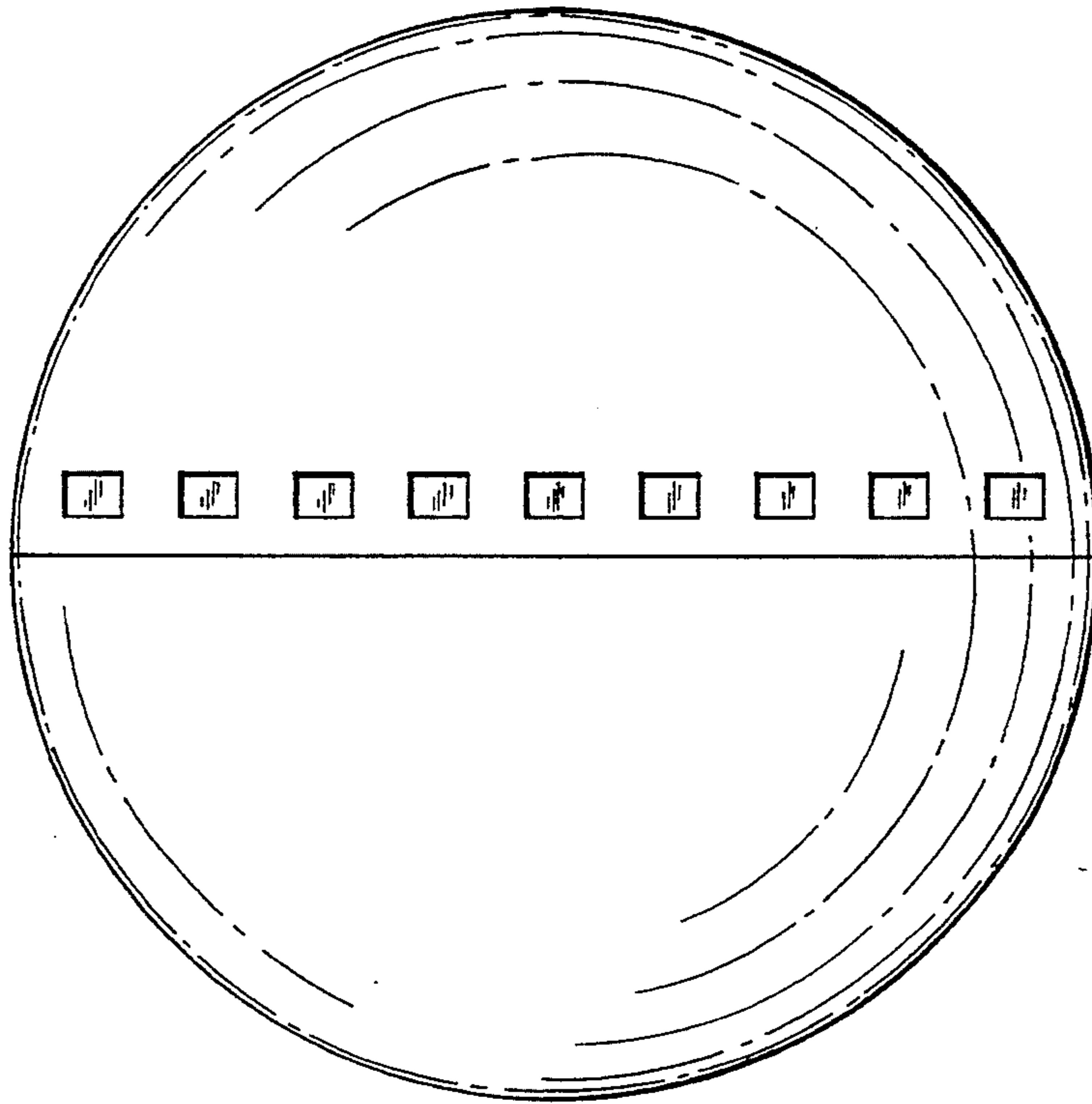

FIG. 5

