



US00D353657S

United States Patent [19]

[11] Patent Number: **Des. 353,657**

Formgren

[45] Date of Patent: **** Dec. 20, 1994**

- [54] SINK
- [75] Inventor: **Anna-Pia K. Formgren**, Paris, France
- [73] Assignee: **Jacob Delafon**, Paris, France
- [**] Term: **14 Years**
- [21] Appl. No.: **14,962**
- [22] Filed: **Nov. 5, 1993**
- [52] U.S. Cl. **D23/290**
- [58] Field of Search 4/619, 625, 629, 638-642,
4/646, 656; D23/287, 284, 289, 290, 293, 294

- [56] **References Cited**
- U.S. PATENT DOCUMENTS**
- 2,028,802 1/1936 Ottke 4/637
- 2,028,803 1/1936 Ottke 4/637

OTHER PUBLICATIONS

P. 15-4 dated Jun. 1993 of a Kohler catalog showing a Model K-5886 kitchen sink, admitted prior art.

Primary Examiner—A. Hugo Word

Assistant Examiner—Eric Watterson
Attorney, Agent, or Firm—Quarles & Brady

[57] CLAIM

The ornamental design for a sink, as shown and described.

DESCRIPTION

FIG. 1 is a perspective view taken from the top, front and right side of a sink embodying my new design; FIG. 2 is a top plan view thereof; FIG. 3 is a cross-sectional view taken on line 3—3 of FIG. 2; FIG. 4 is a cross-sectional view taken on line 4—4 of FIG. 2; FIG. 5 is a cross-sectional view taken on line 5—5 of FIG. 2; FIG. 6 is a cross-sectional view taken on line 6—6 of FIG. 2; and, FIG. 7 is a top plan view of a second embodiment which is the mirror image of the embodiment of FIG. 1. The fragmentary broken line representations in FIGS. 1, 2 and 7 are for the purpose of illustration only and form no part of the claimed design.

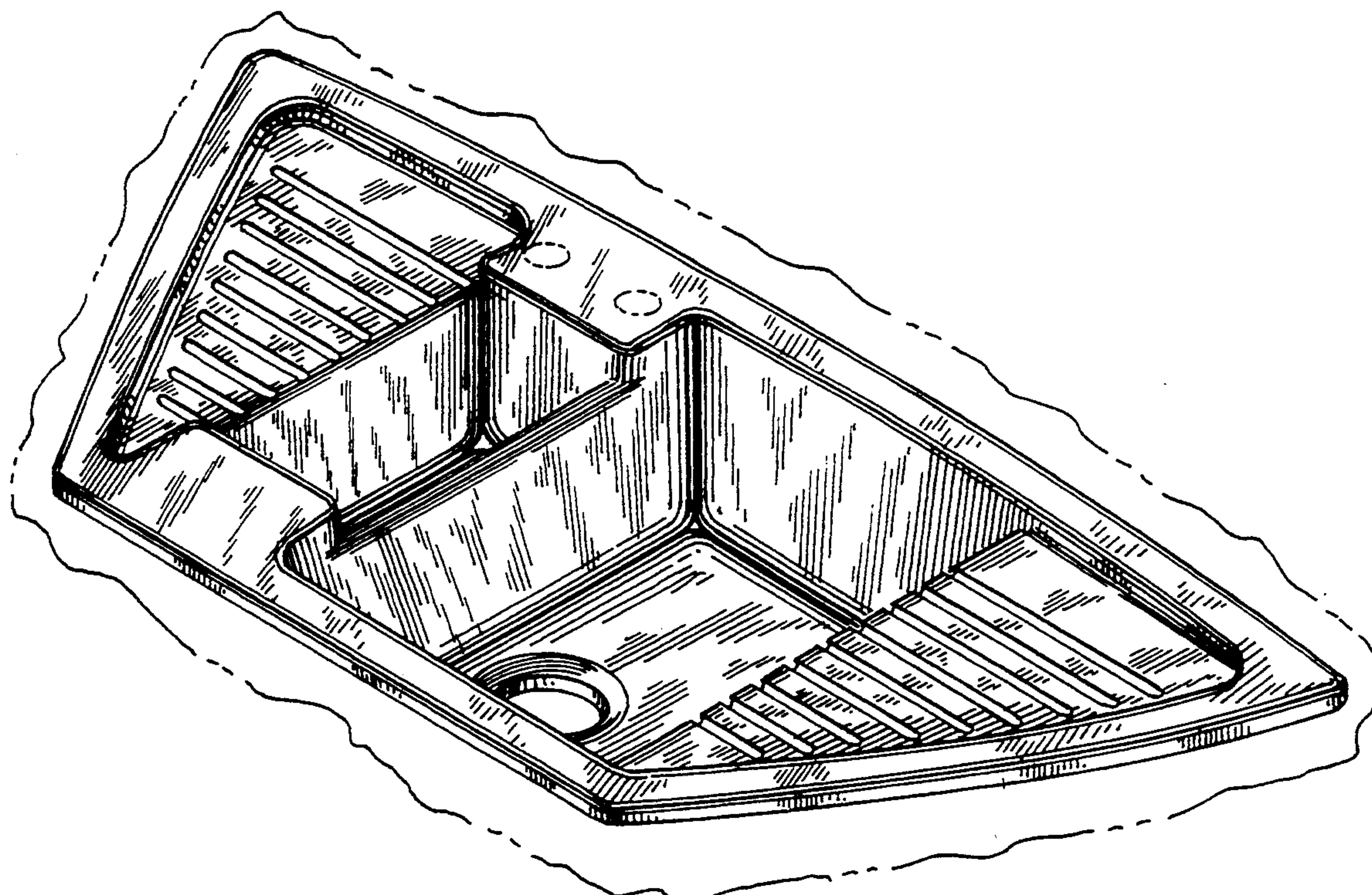

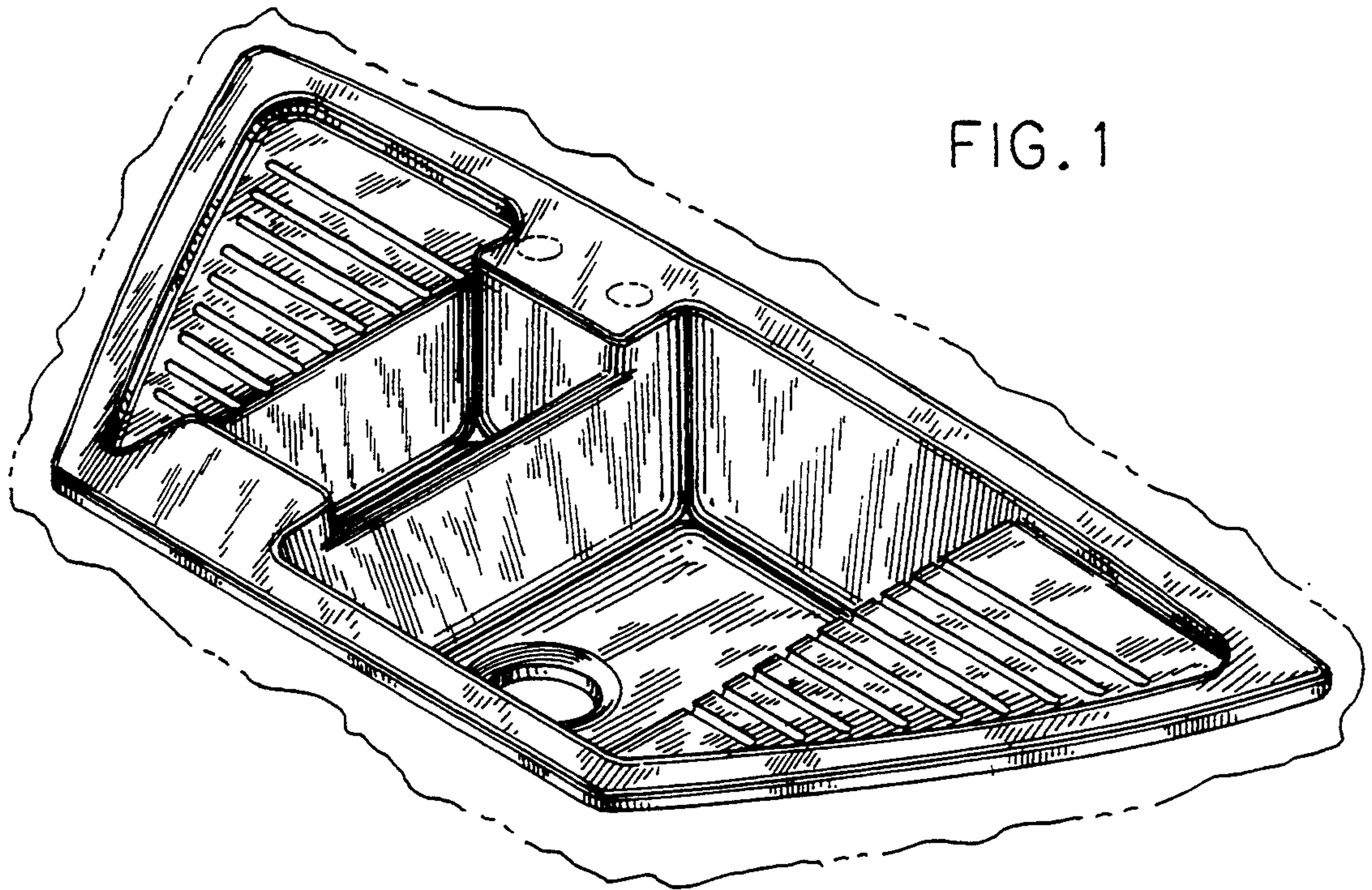

FIG. 1

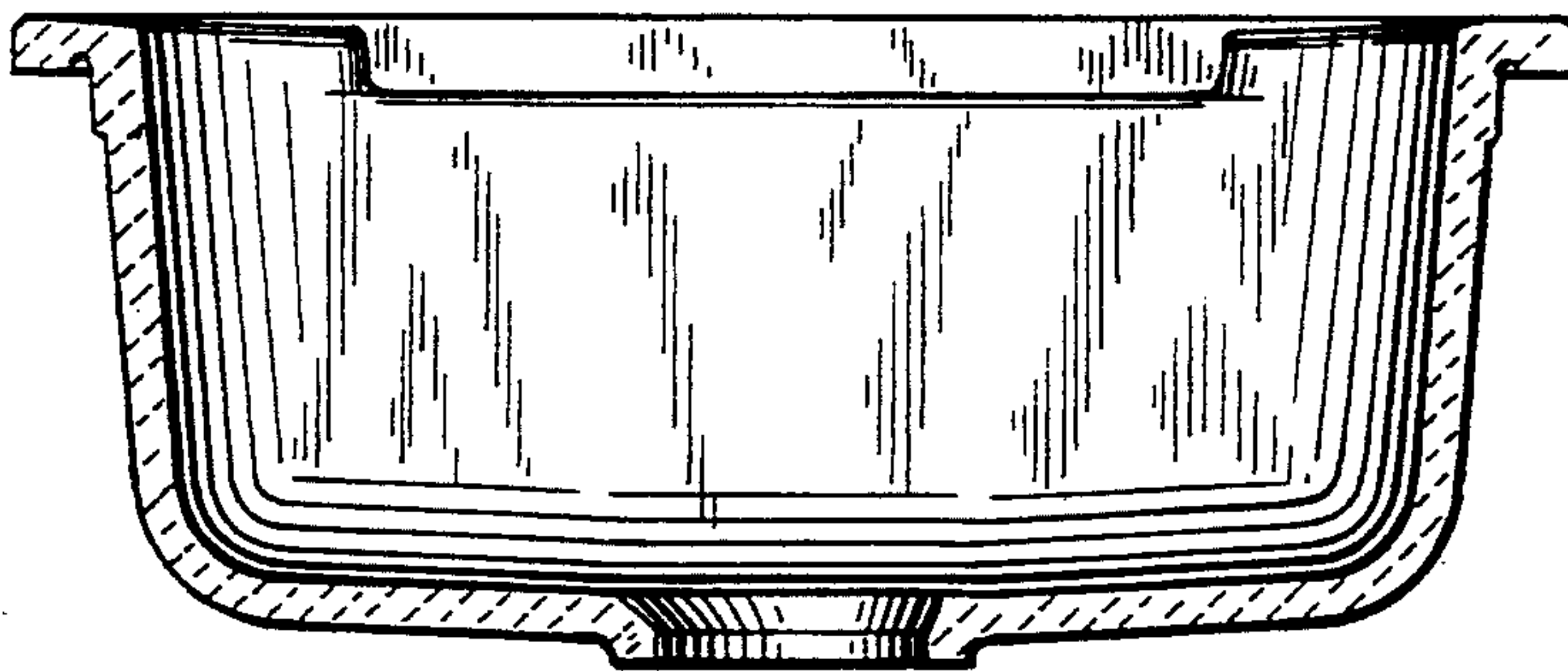

FIG. 4

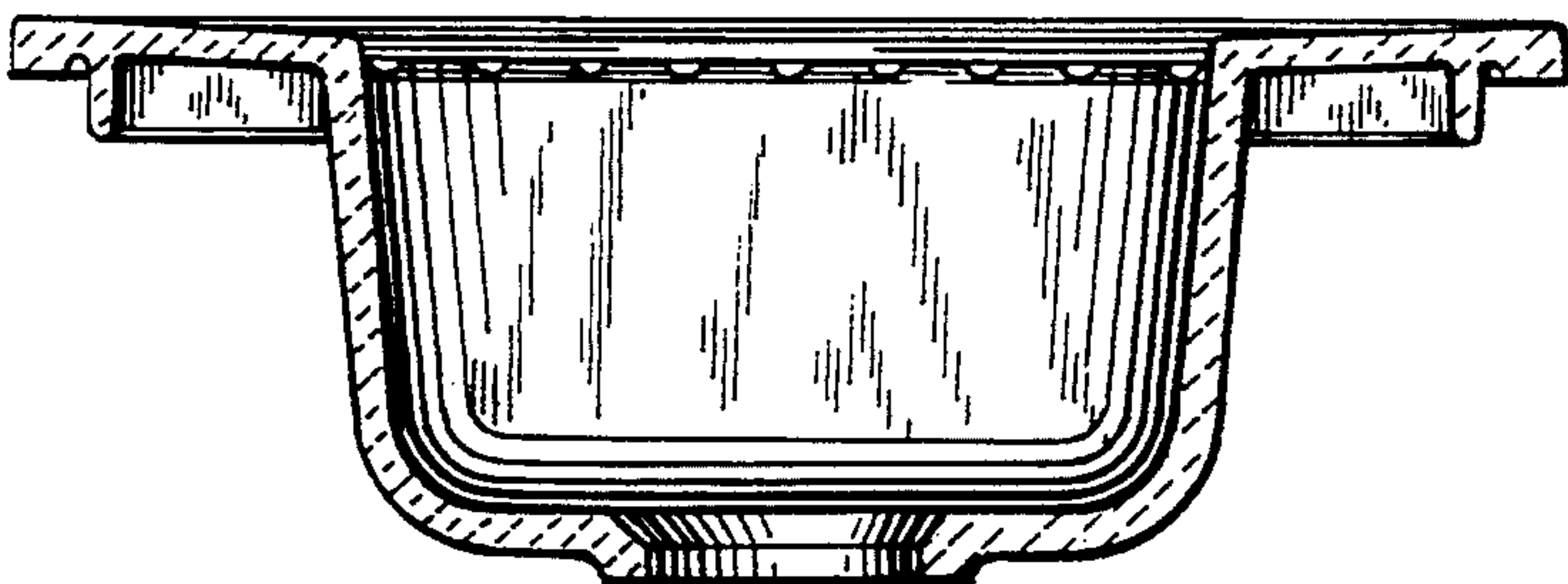

FIG. 5

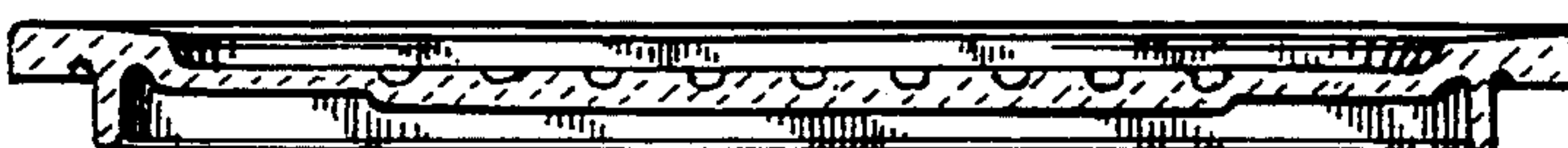

FIG. 6

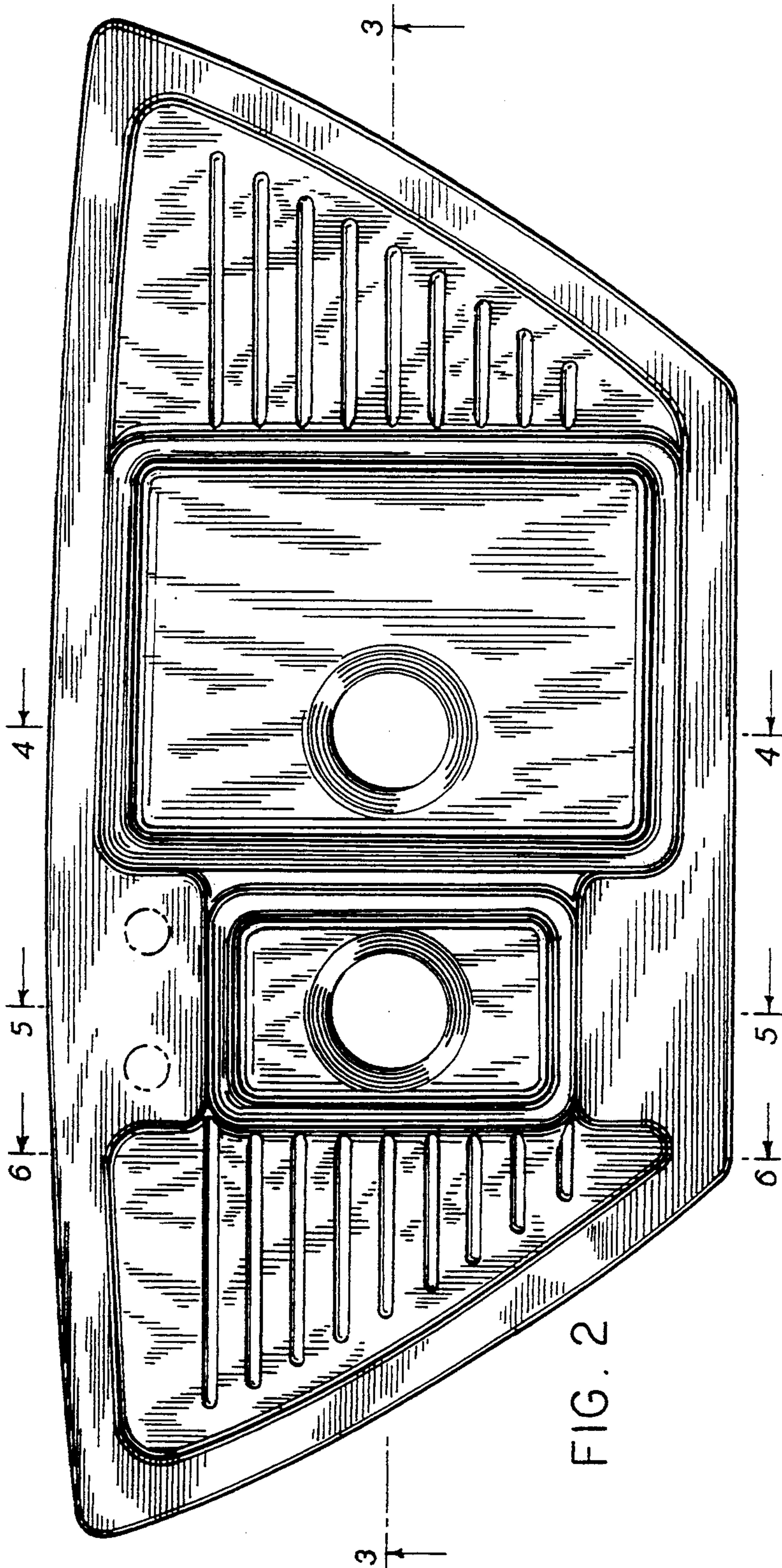

FIG. 2

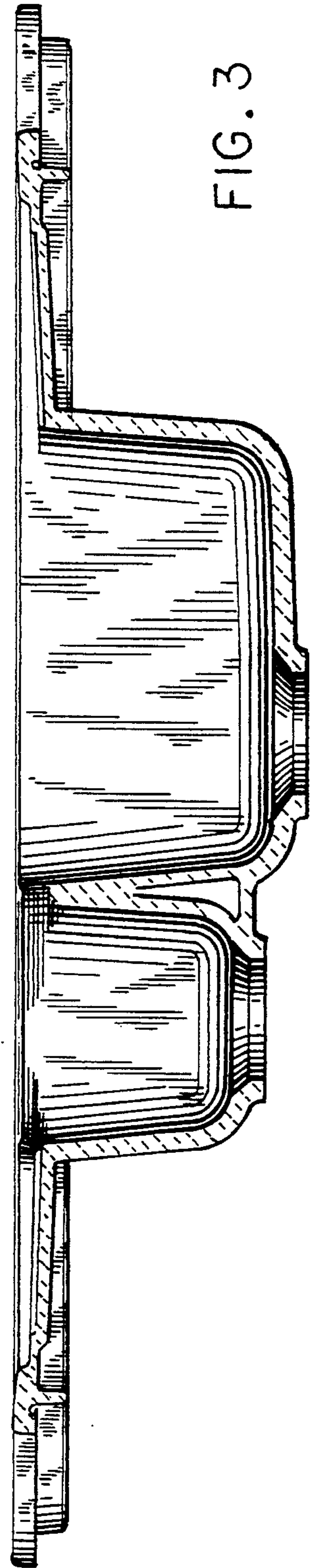

FIG. 3

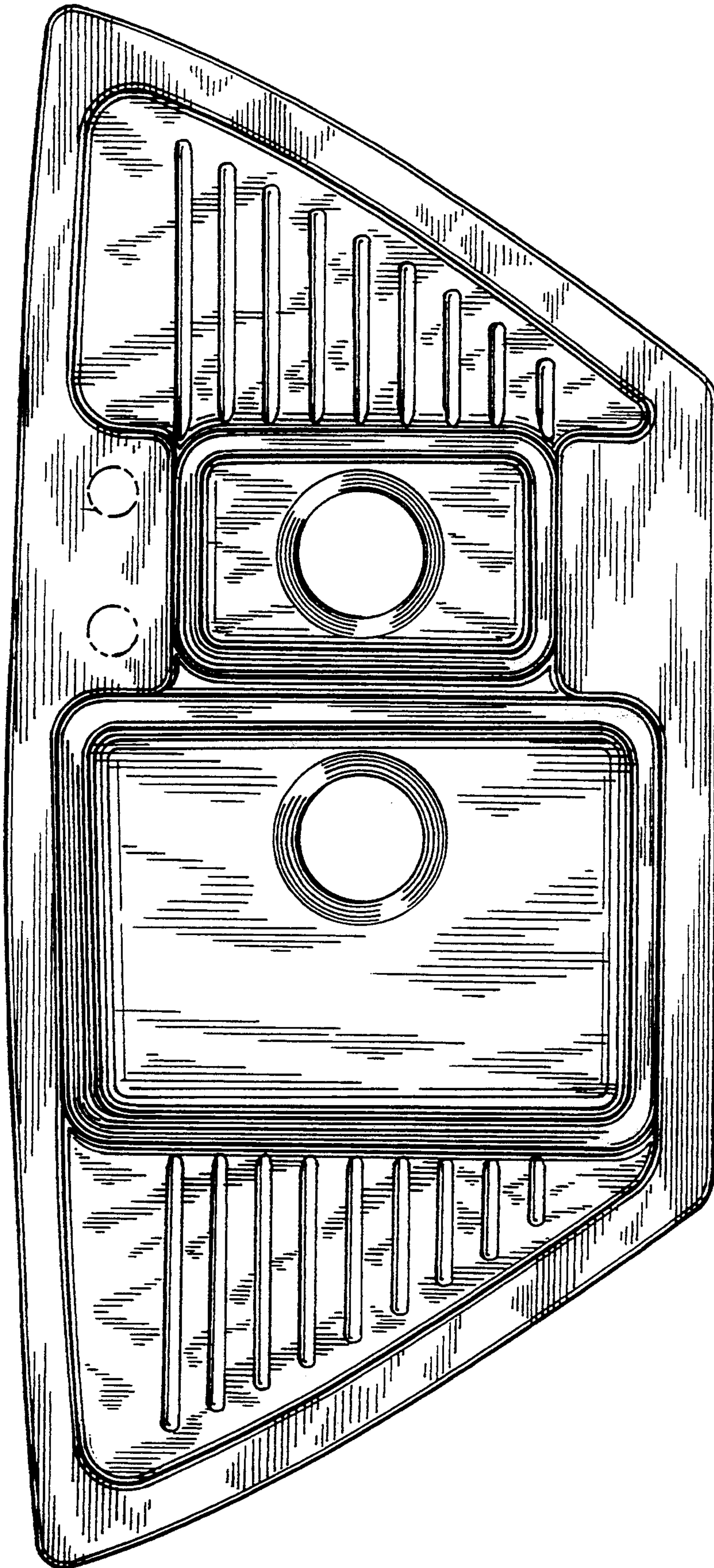

FIG. 7