



US00D353636S

# United States Patent [19]

[11] Patent Number: **Des. 353,636**

**Le Roux**

[45] Date of Patent: **\*\* Dec. 20, 1994**

[54] **EXERCISE STEP**

[75] Inventor: **Philippe Le Roux**, Church Brampton, United Kingdom

[73] Assignee: **The Green Journal Ltd.**, Chapel Brampton, United Kingdom

[\*\*] Term: **14 Years**

[21] Appl. No.: **886,699**

[22] Filed: **May 21, 1992**

[30] **Foreign Application Priority Data**

Nov. 21, 1991 [GB] United Kingdom ..... 2019088

Nov. 21, 1991 [GB] United Kingdom ..... 2019089

[52] U.S. Cl. .... **D21/191**

[58] Field of Search ..... D6/349, 367; 482/52; 297/438, 439; 108/144, 11, 12, 156; D21/191; D25/63, 65

[56] **References Cited**

**U.S. PATENT DOCUMENTS**

- D. 123,160 10/1940 Daily ..... D34/31
- D. 157,319 2/1950 Bair ..... D25/63
- D. 194,399 1/1963 De Muth et al. .... D25/63
- D. 267,969 2/1983 Rodger ..... D6/349
- D. 268,280 3/1983 Rodger ..... D23/71
- D. 281,260 11/1985 Smith ..... D21/66
- D. 298,266 10/1988 Reyneke ..... D21/191
- D. 298,786 12/1988 Wilkinson ..... D6/367
- D. 313,521 1/1991 Hassel et al. .... D6/349
- D. 318,958 8/1991 Ahlström et al. .... D6/349
- D. 320,702 10/1991 Dewing ..... D6/349
- D. 323,537 1/1992 Wilkinson ..... D21/191
- D. 326,530 5/1992 Lewis ..... D25/113
- D. 330,057 10/1992 Saunders et al. .... D21/191
- D. 330,234 10/1992 Saunders et al. .... D21/191
- D. 330,235 10/1992 Traetta et al. .... D21/191
- D. 337,211 7/1993 Bergkvist ..... D6/349
- D. 337,362 7/1993 Goldstein et al. .... D21/191
- D. 339,179 9/1993 Wilkinson ..... D21/191
- D. 342,298 12/1993 Schnabel, Jr. et al. .... D21/191
- 513,311 1/1994 Epstein ..... 108/34
- 746,978 12/1903 Mohr .
- 1,978,650 10/1934 Shannon .
- 2,097,273 10/1937 Feist .
- 2,172,609 9/1939 Fogg ..... 108/144
- 3,653,715 4/1972 Drabert et al. .... 297/439

- 3,907,068 9/1975 Ulerich ..... 182/194
- 4,106,413 8/1978 Hoaglund ..... 108/12
- 4,191,111 3/1980 Emmert ..... 108/132
- 4,549,767 10/1985 Hampshire et al. .... 297/439
- 4,678,234 7/1987 Wilson ..... 297/469
- 4,715,296 12/1987 Wilkinson ..... 108/116
- 4,759,542 7/1988 Hudec ..... 272/111
- 4,813,742 3/1989 Cardinael ..... 297/439
- 4,984,785 1/1991 Wilkinson ..... 482/52
- 5,037,084 8/1991 Flor ..... 482/52
- 5,050,861 9/1991 Thomas et al. .... 272/70
- 5,096,186 3/1992 Wilkinson et al. .... 272/70

**FOREIGN PATENT DOCUMENTS**

- 901614 5/1972 Canada ..... 272/30
- 1079004 8/1967 United Kingdom ..... A47C 9/12
- WO91/04767 4/1991 WIPO ..... A63B 1/00
- WO92/06744 4/1992 WIPO ..... A63B 5/00

**OTHER PUBLICATIONS**

Sutton, R., *The Washington Post*, p. B5, Sep. 24, 1990.

*Primary Examiner*—Bernard Ansher

*Assistant Examiner*—Philip Hyder

*Attorney, Agent, or Firm*—Sterne, Kessler, Goldstein & Fox

[57] **CLAIM**

The ornamental design for an exercise step, as shown and described.

**DESCRIPTION**

FIG. 1 is a perspective view of an exercise step showing my new design, in a first position; FIG. 2 is a front elevational view thereof, the rear view of the exercise step being a mirror image of the same; FIG. 3 is a side elevational view thereof, the opposite side view of the exercise step being a mirror image of the same; FIG. 4 is a bottom plan view thereof; FIG. 5 is a perspective view of the exercise step of FIG. 1 shown in a second position; FIG. 6 is a front elevational view thereof, the rear view of the exercise step being a mirror image of the same; FIG. 7 is a side elevational view thereof, the opposite side view of the exercise step being a mirror image of the same; FIG. 8 is a bottom plan view thereof;

(Description continued on next page.)

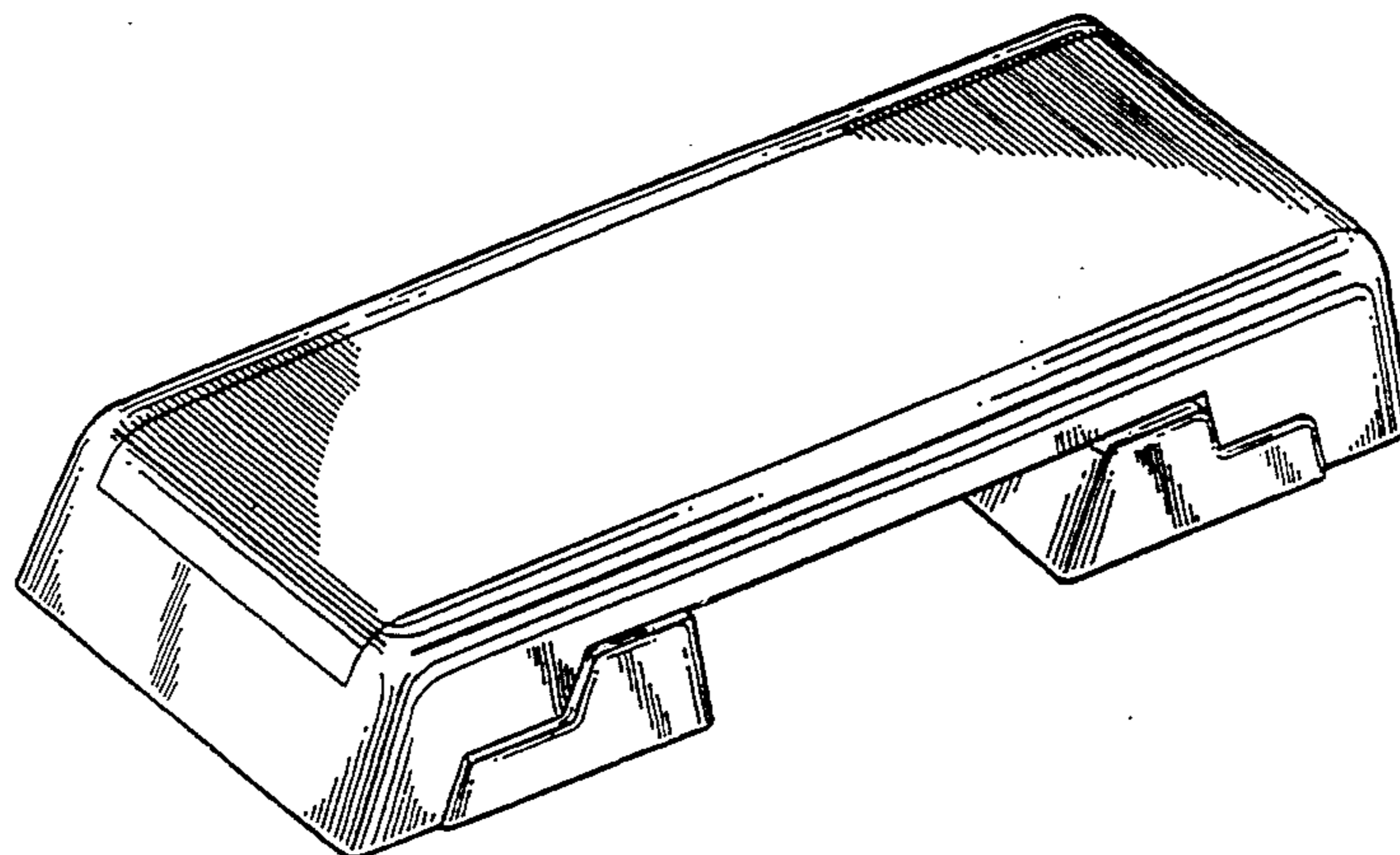

FIG. 9 is a perspective view of the exercise step of FIG. 1 shown in a third position;

FIG. 10 is a front elevational view thereof, the rear view of the exercise step being a mirror image of the same;

FIG. 11 is a side elevational view thereof, the opposite side view of the exercise step being a mirror image of the same;

FIG. 12 is a bottom plan view thereof;

FIG. 13 is a perspective view of the bench component of the exercise step of FIG. 1 shown separate for clarity of illustration;

FIG. 14 is a front elevational view thereof, the rear view of the bench component being a mirror image of the same;

FIG. 15 is a side elevational view thereof, the opposite

side view of the bench component being a mirror image of the same;

FIG. 16 is a perspective view of the leg component of the exercise step shown in FIG. 1 shown separate for clarity of illustration;

FIG. 17 is a front elevational view thereof;

FIG. 18 is a rear elevational view thereof;

FIG. 19 is a side elevational view thereof, the opposite side view of the leg component being a mirror image of the same;

FIG. 20 is a top plan view thereof; and,

FIG. 21 is a bottom plan view thereof.

The broken line showing of the connectors of the leg component in FIGS. 16-21 is environmental only and forms no part of the claimed design.

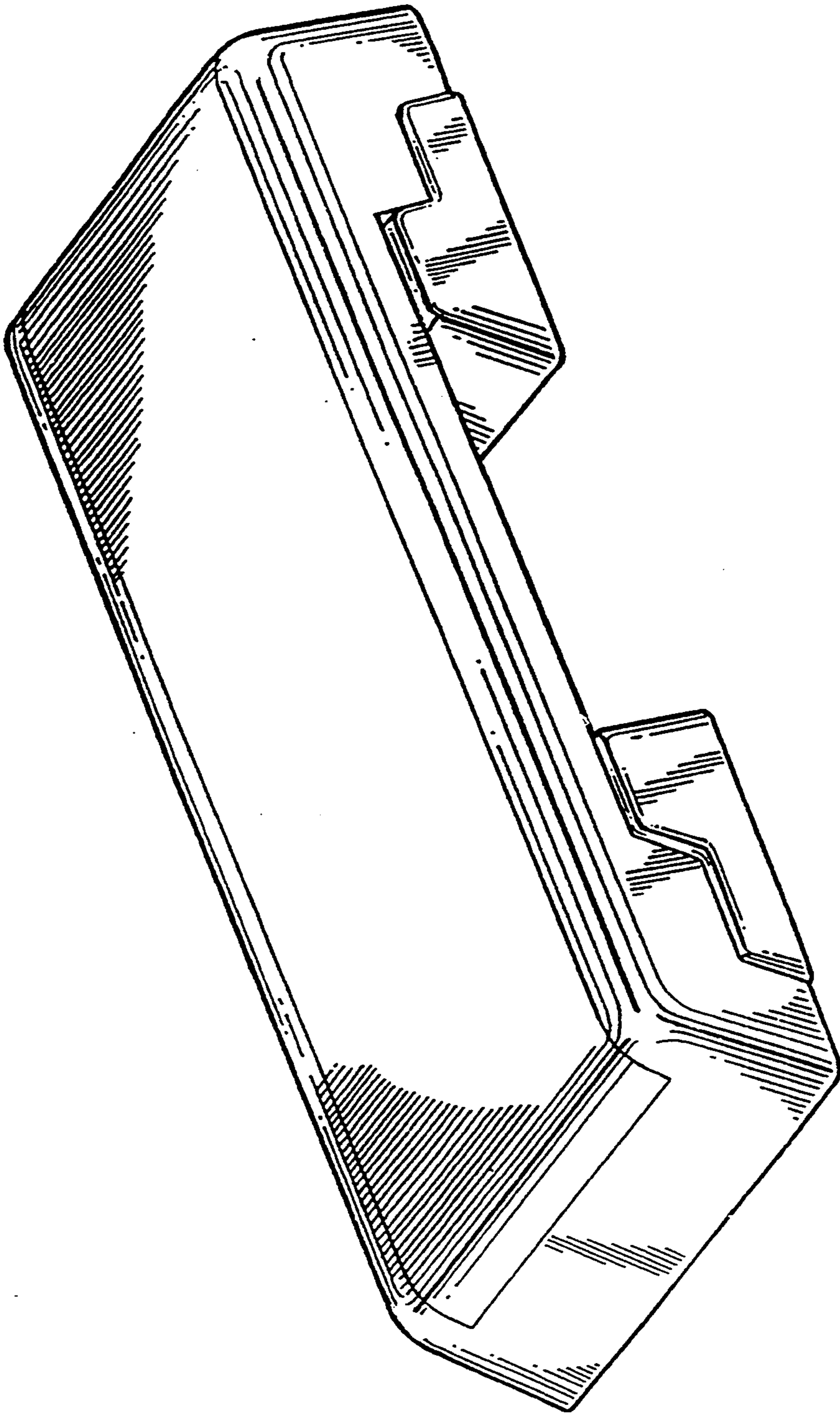

FIG. 1

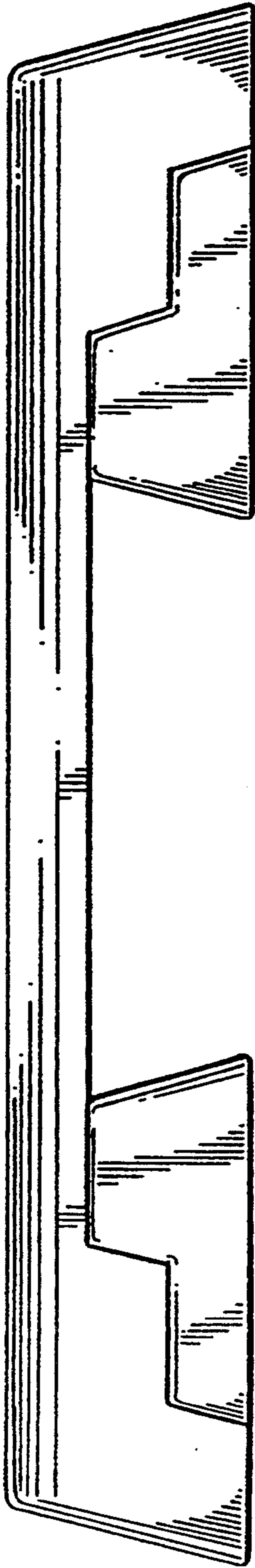

FIG. 2

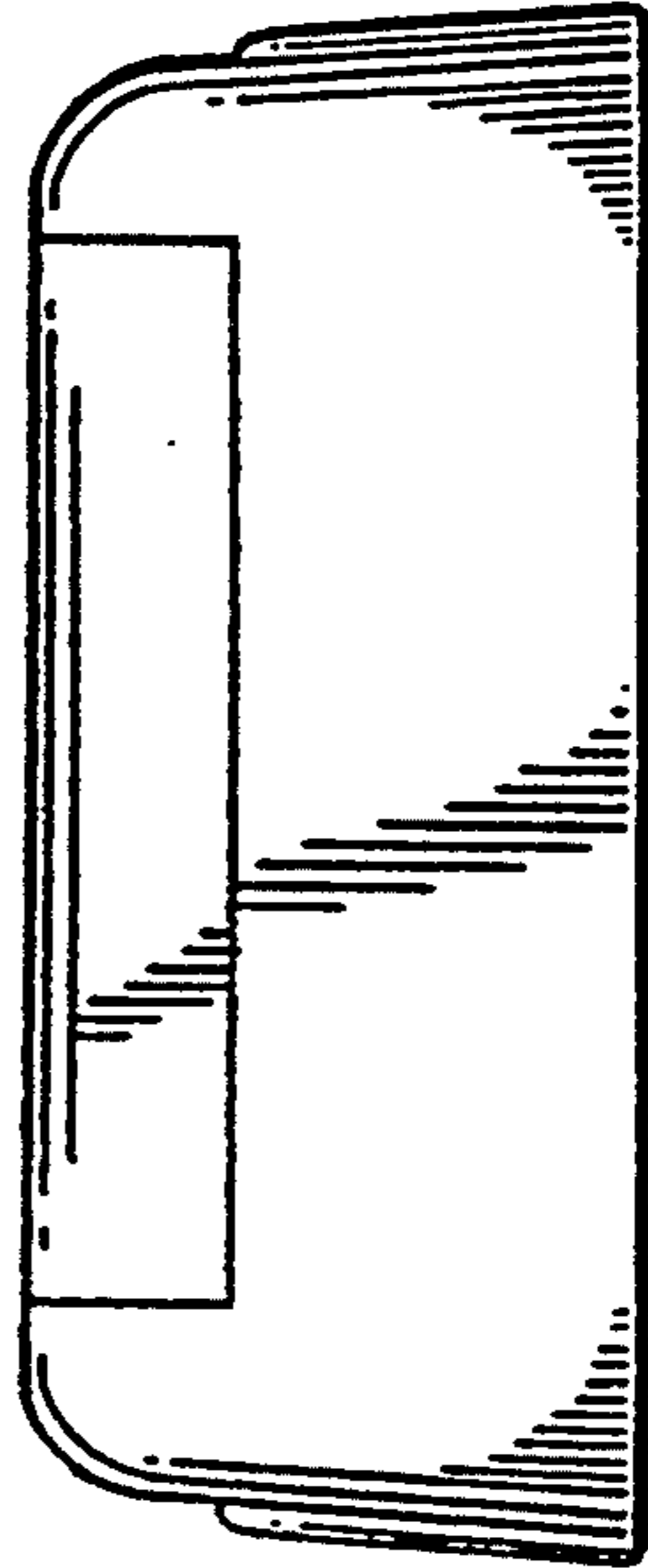

FIG. 3

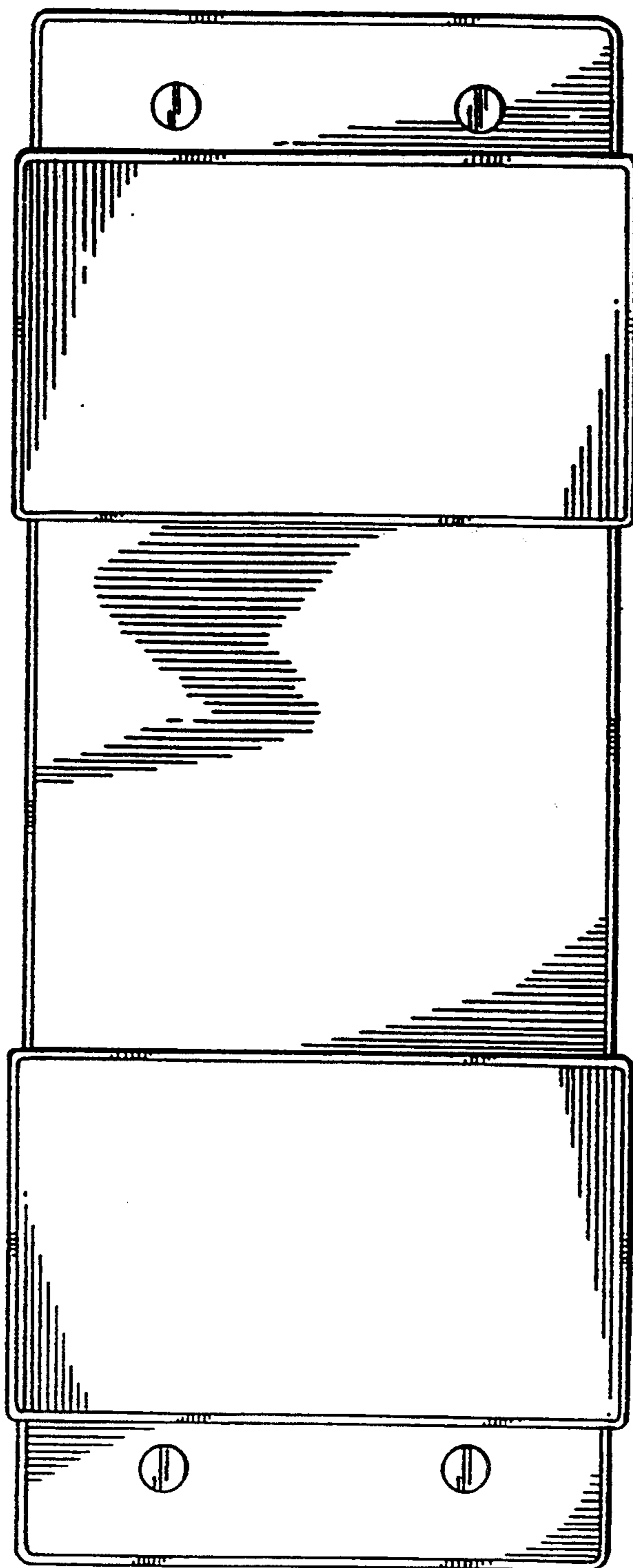

FIG. 4

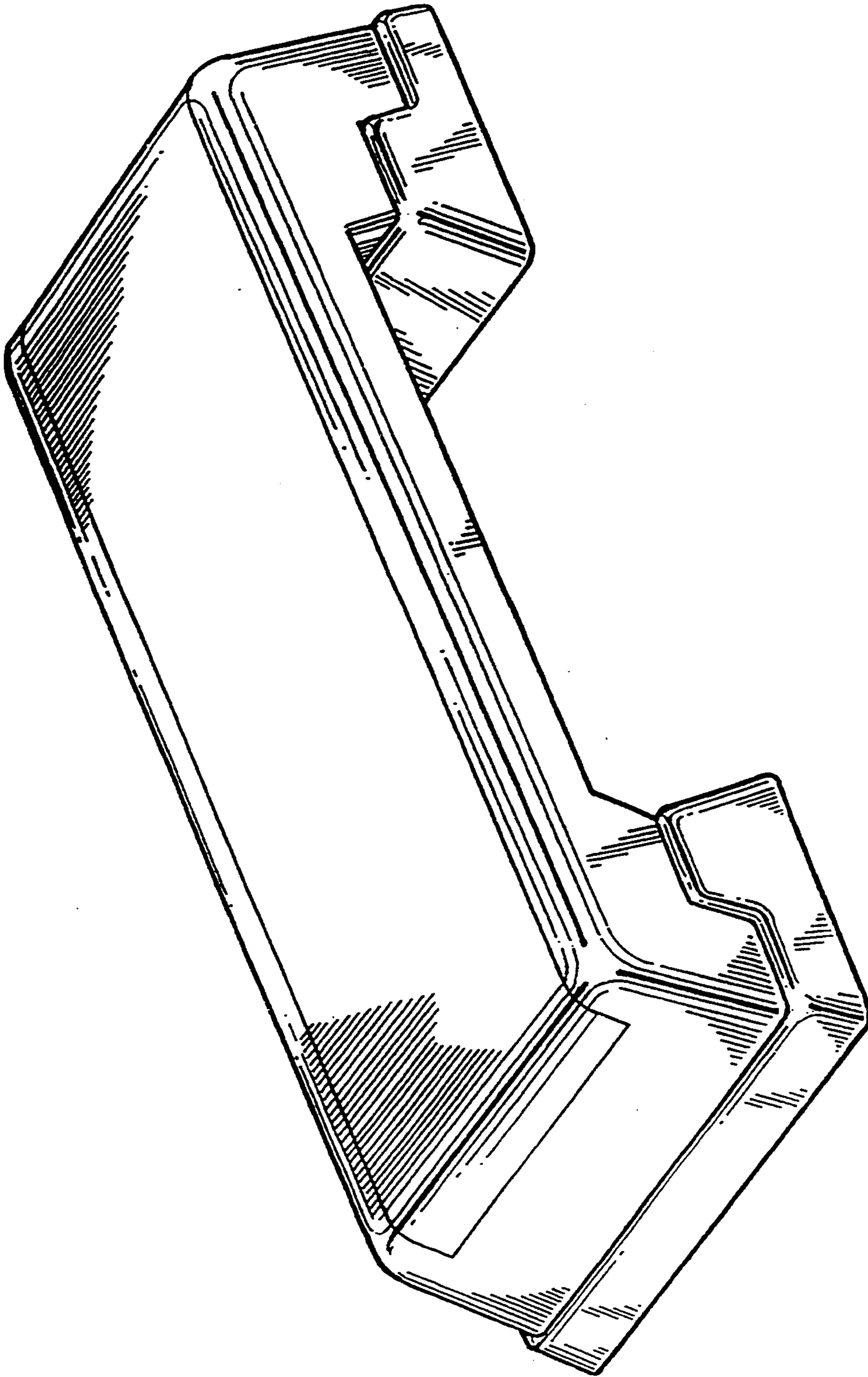

FIG. 5

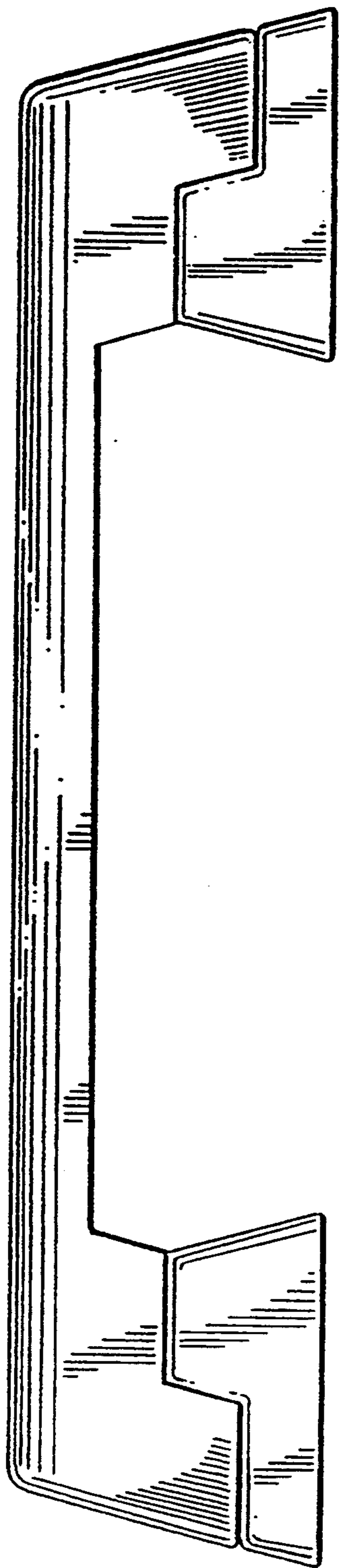

FIG. 6

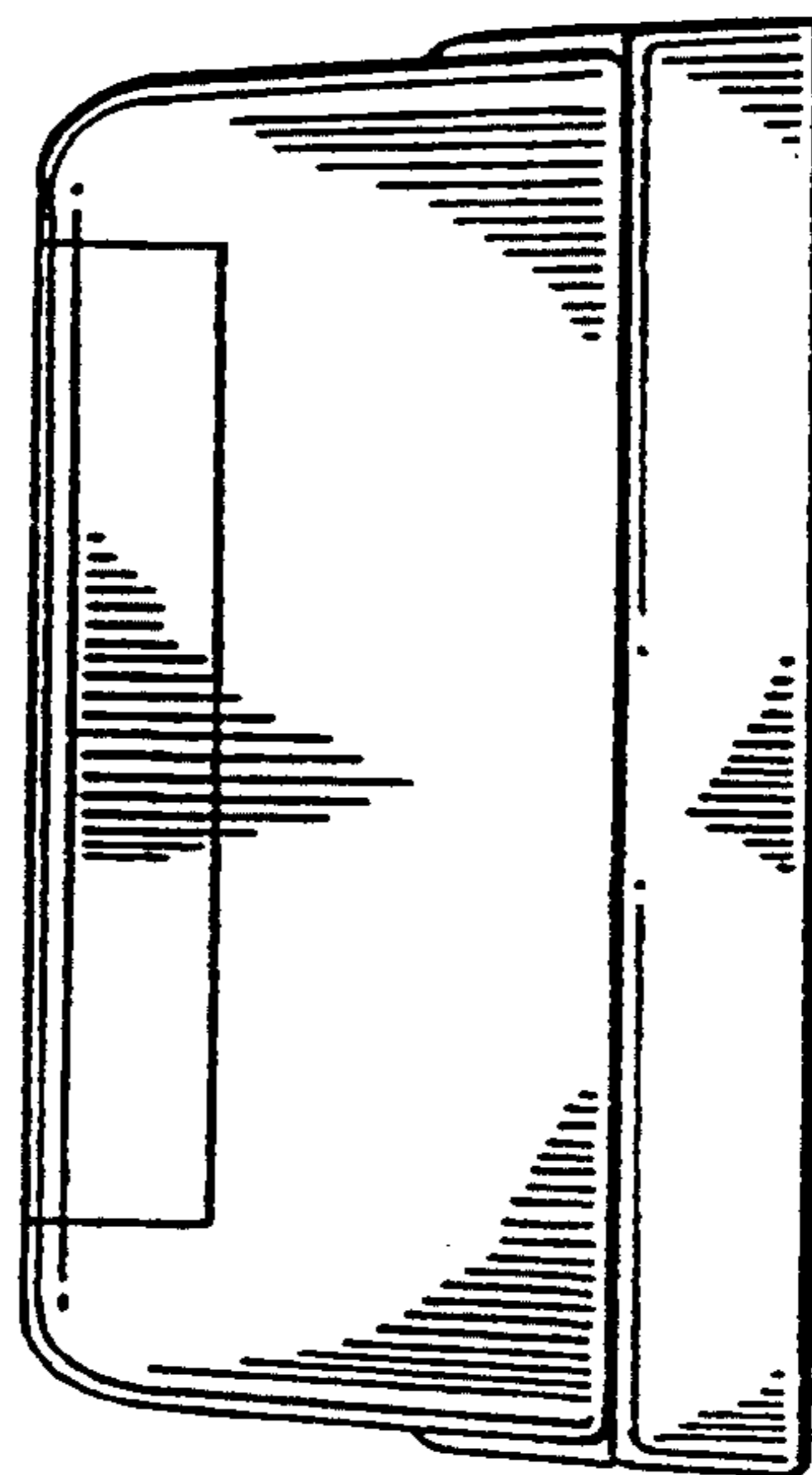

FIG. 7

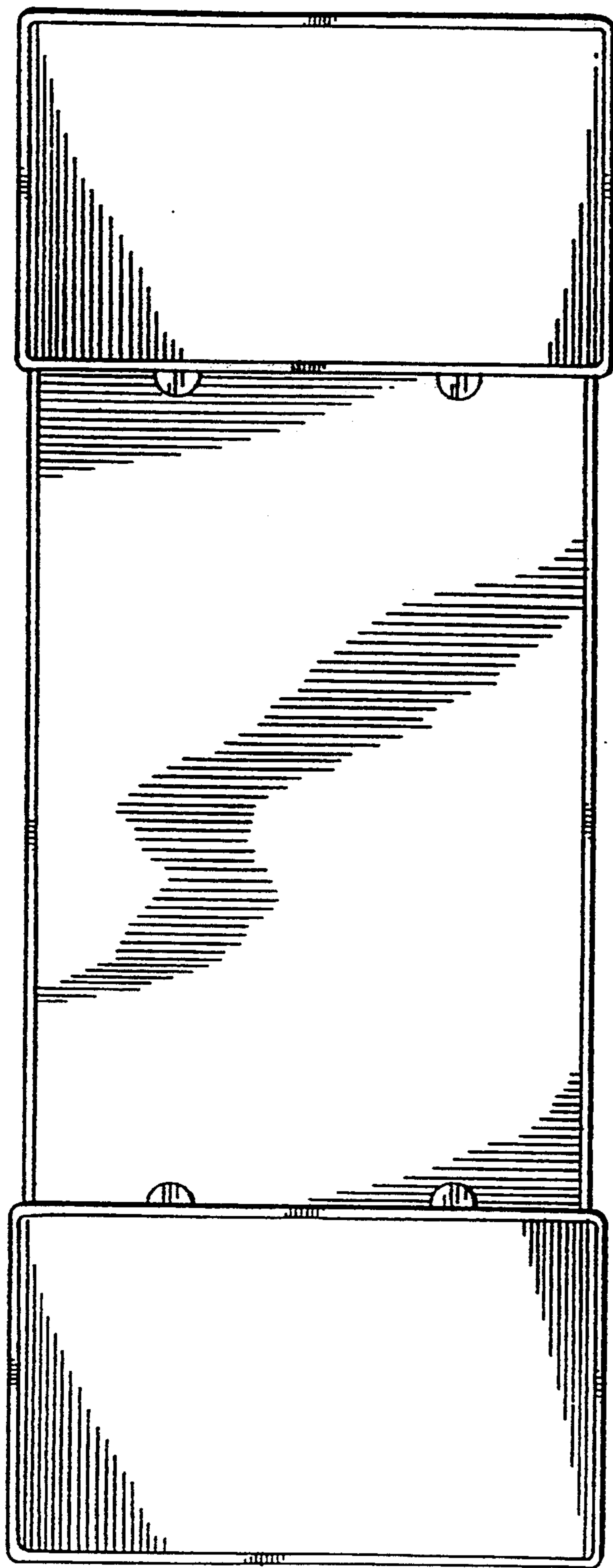

FIG. 8



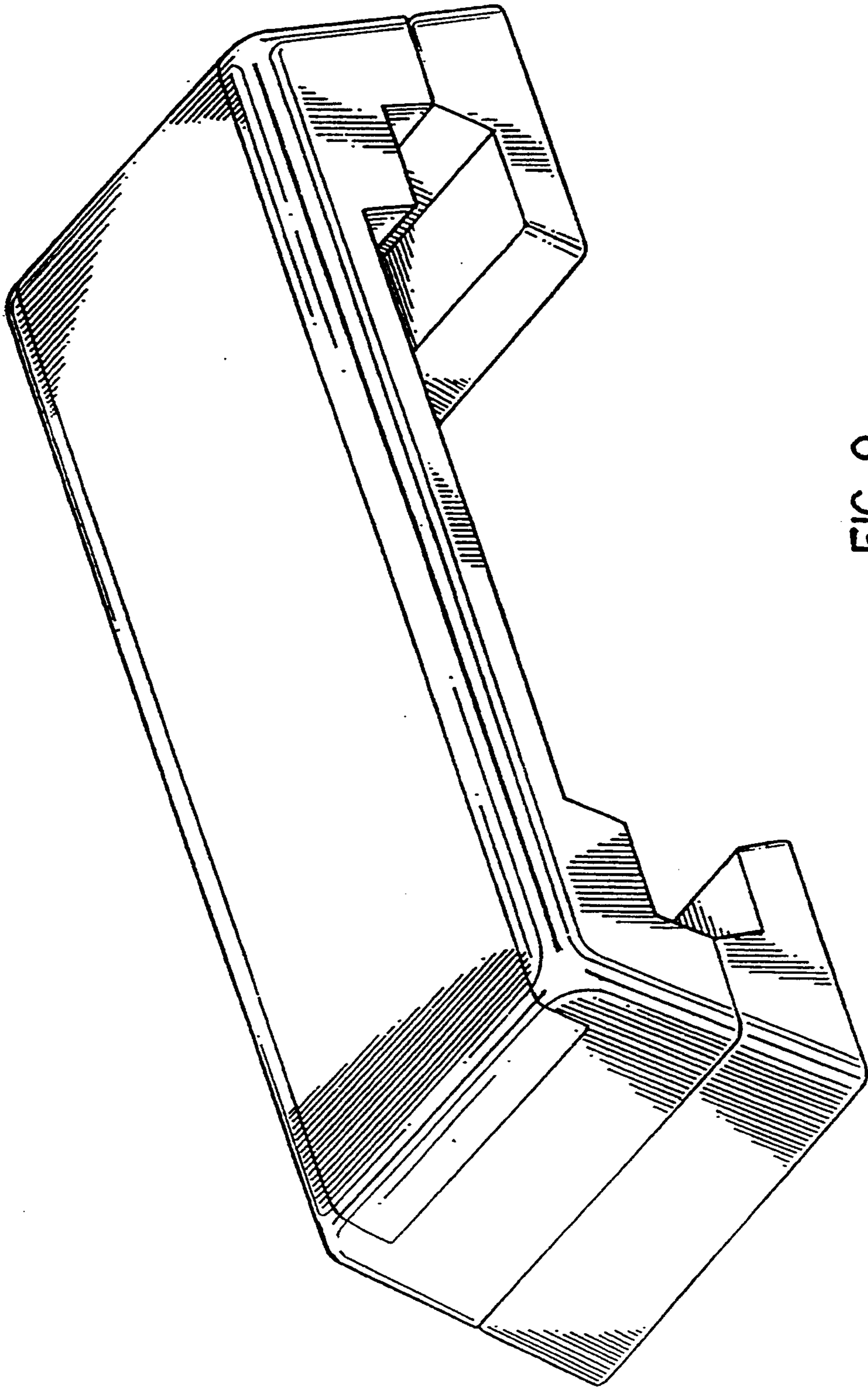

FIG. 9

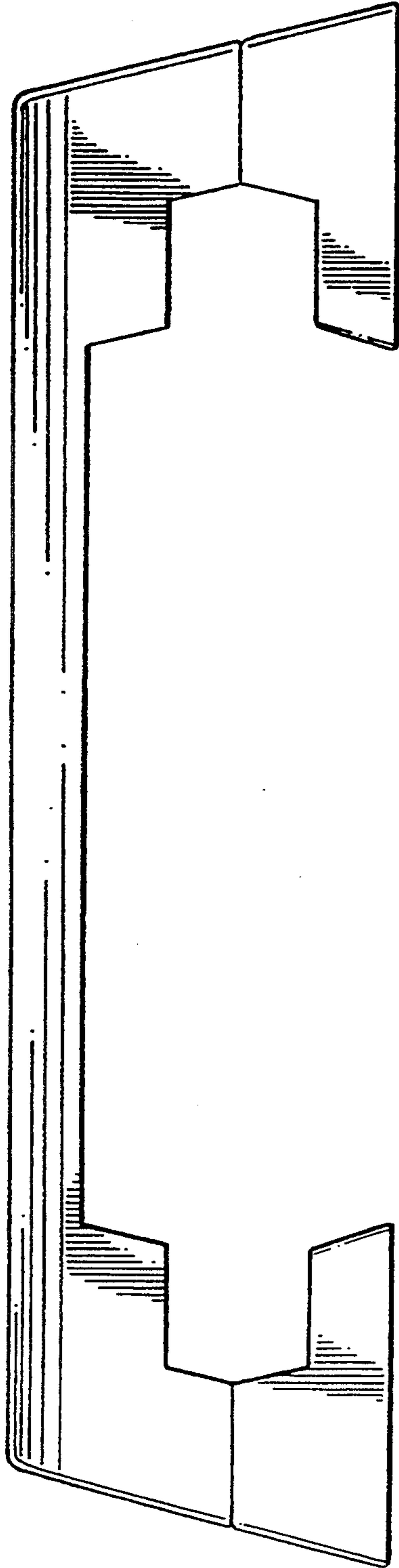

FIG. 10

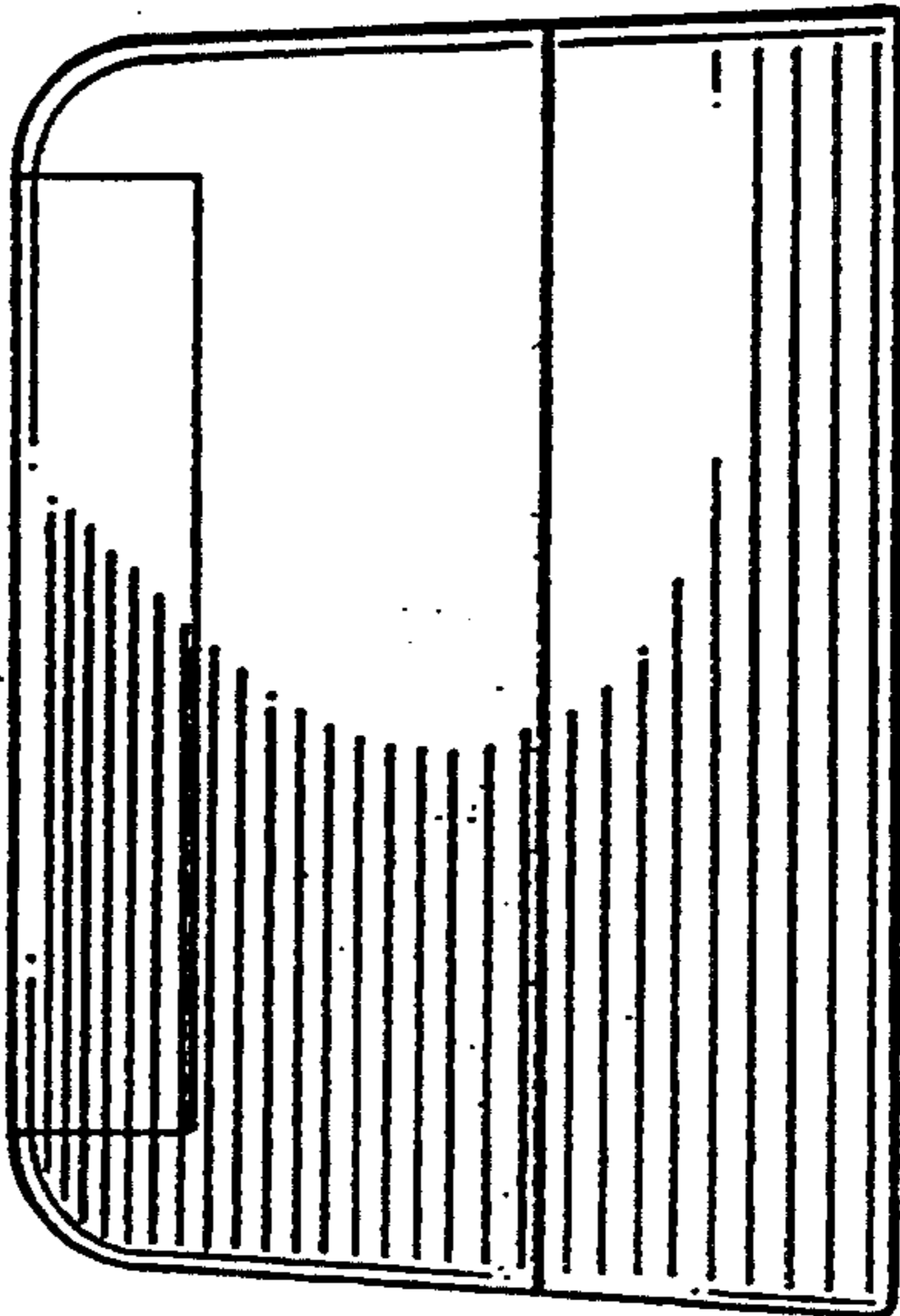

FIG. 11

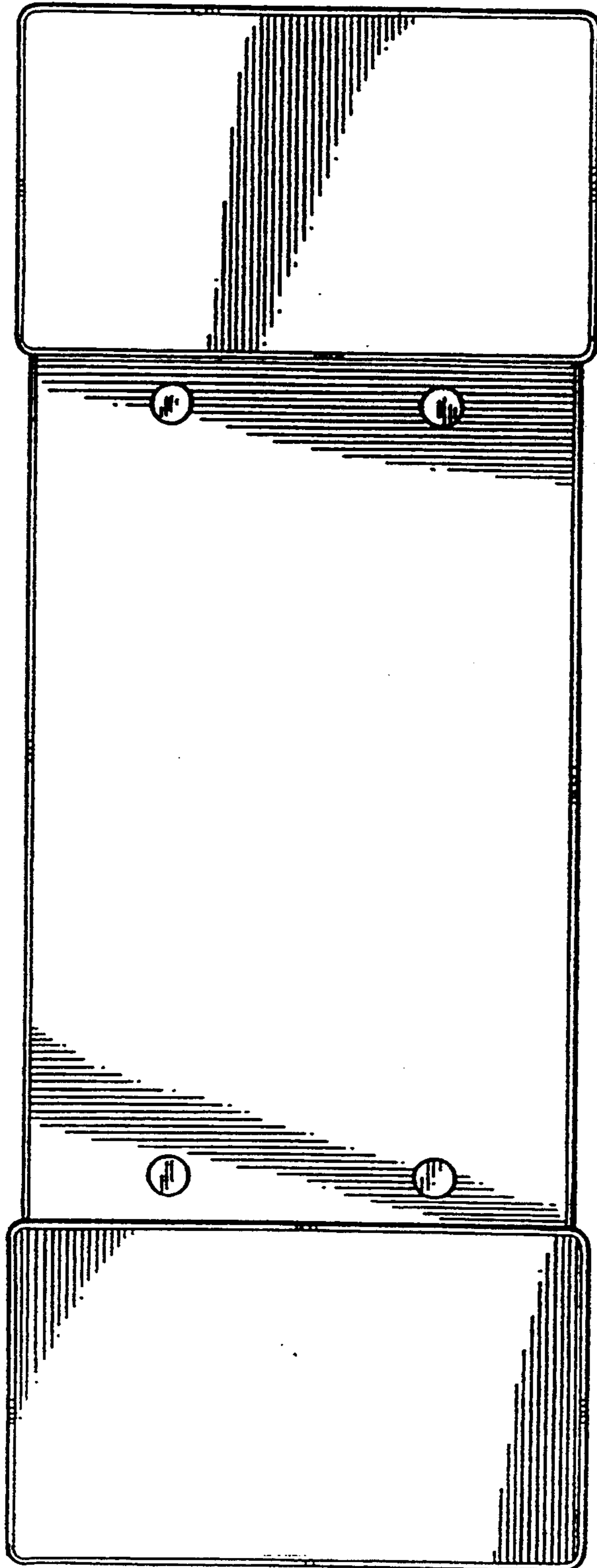

FIG. 12

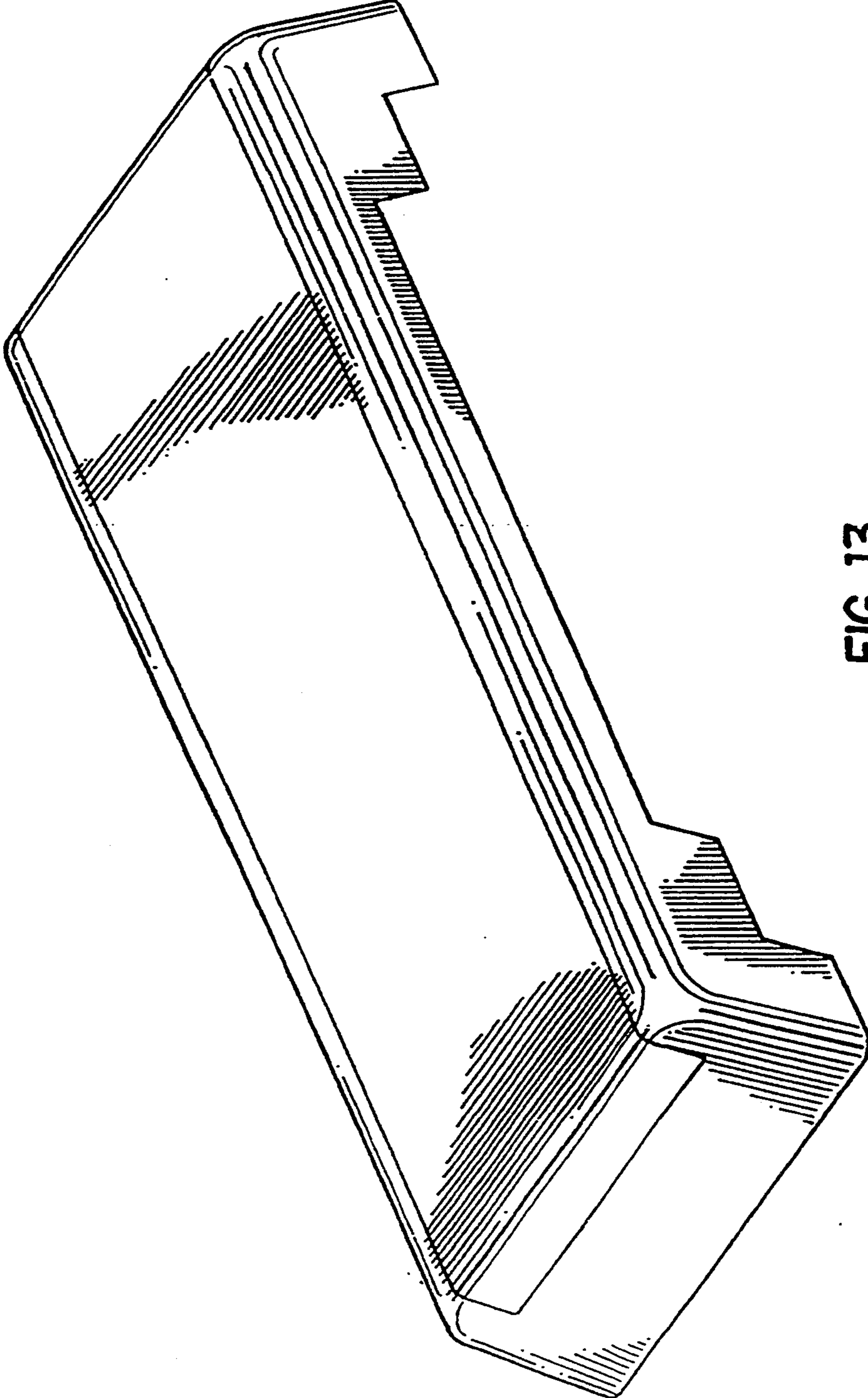

FIG. 13

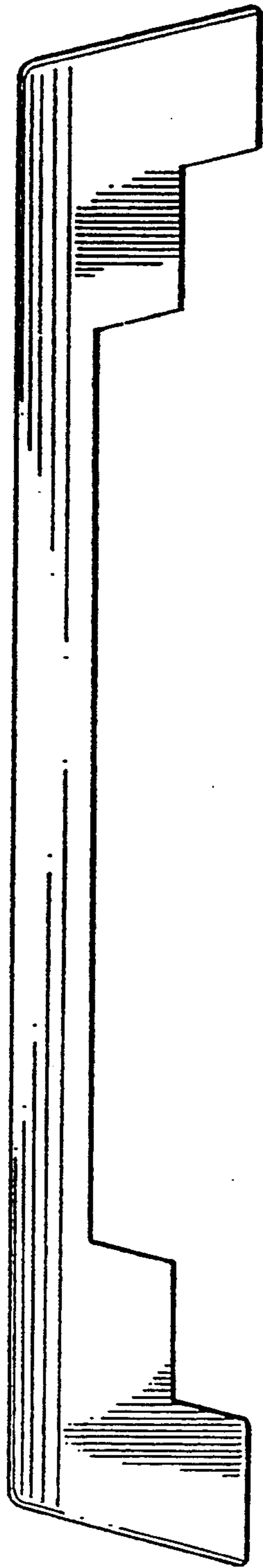

FIG. 14

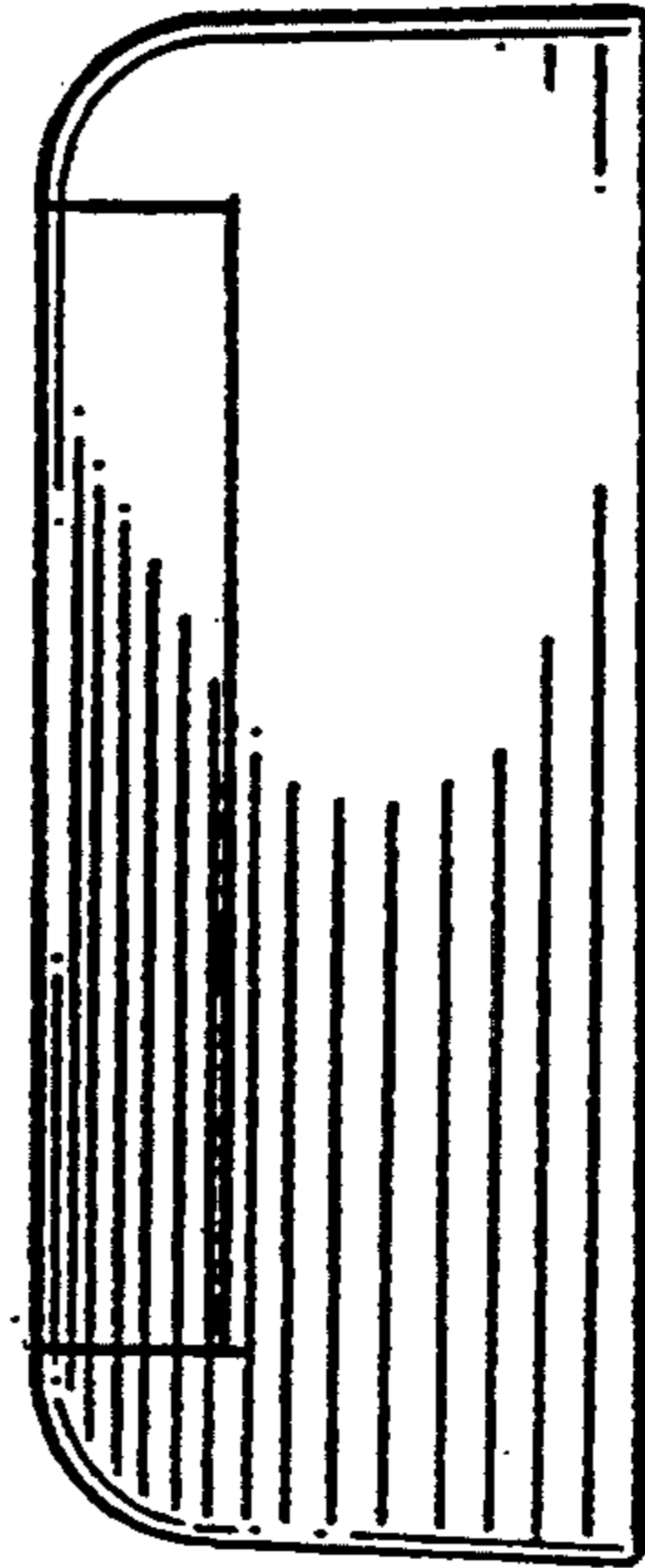

FIG. 15

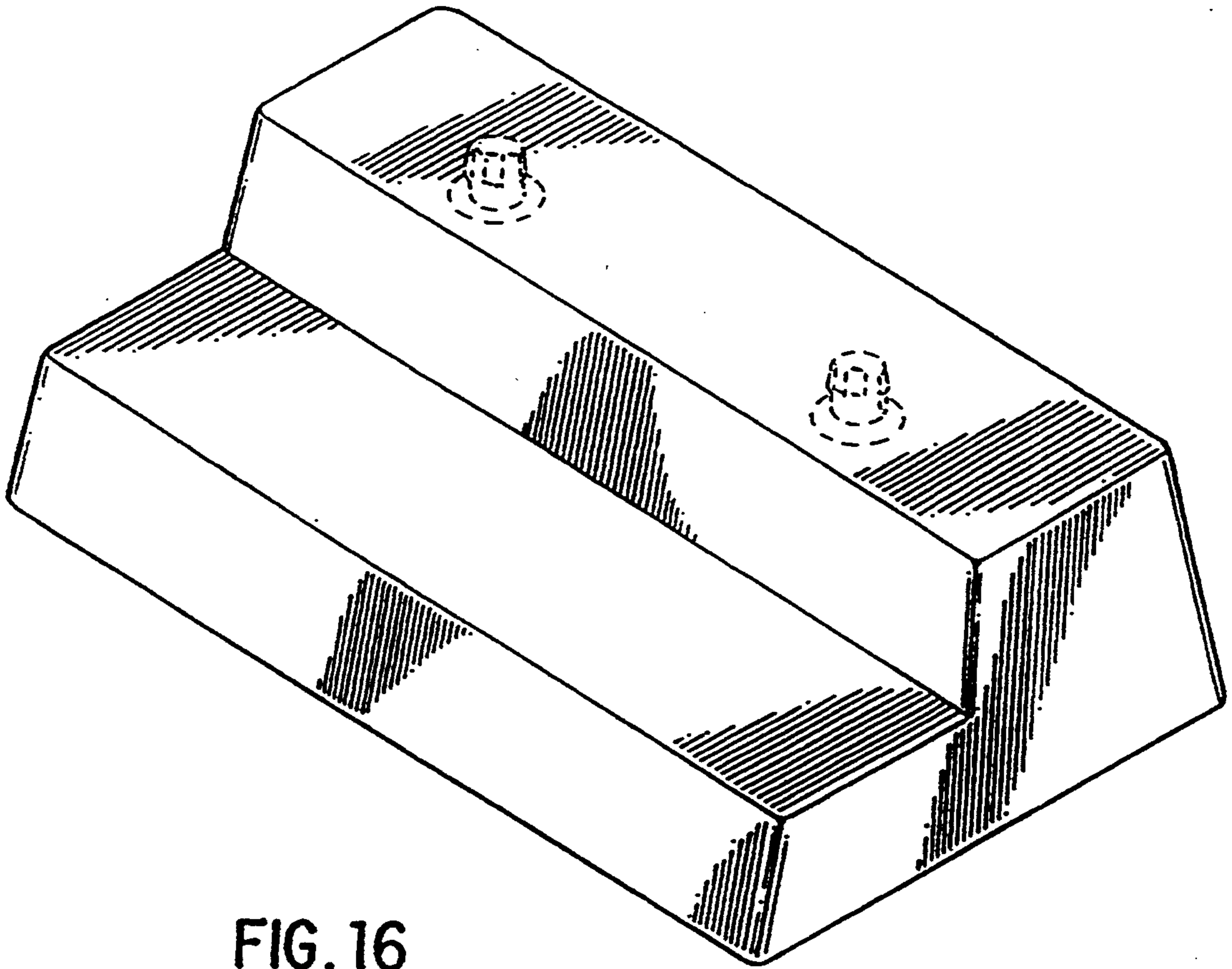

FIG. 16

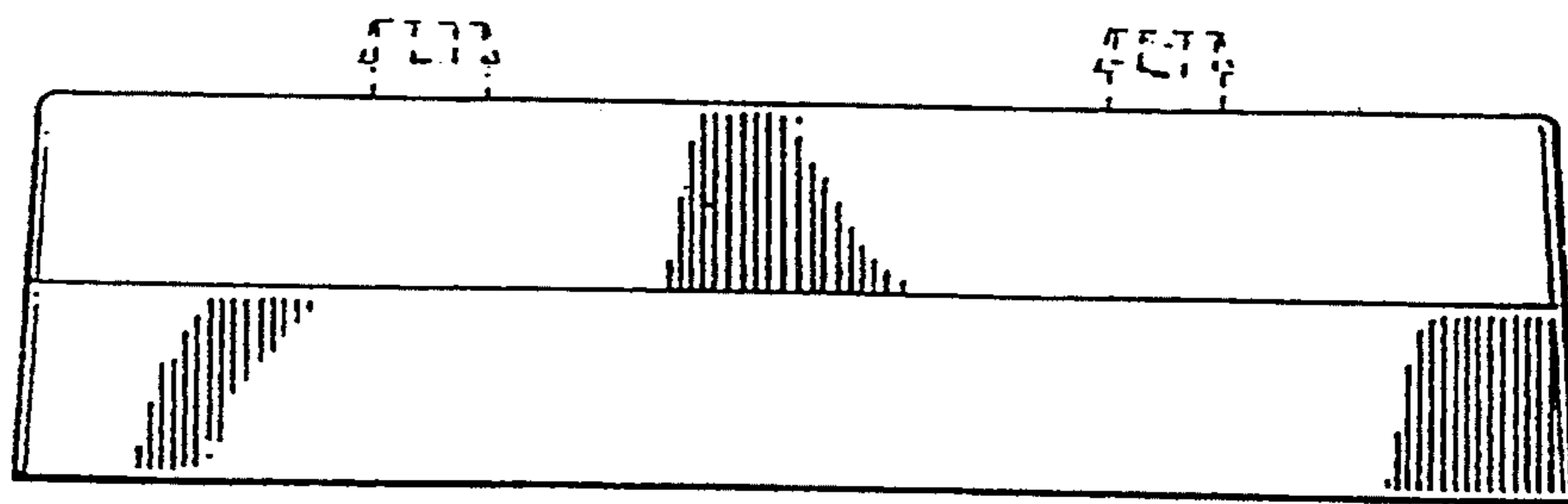

FIG. 17

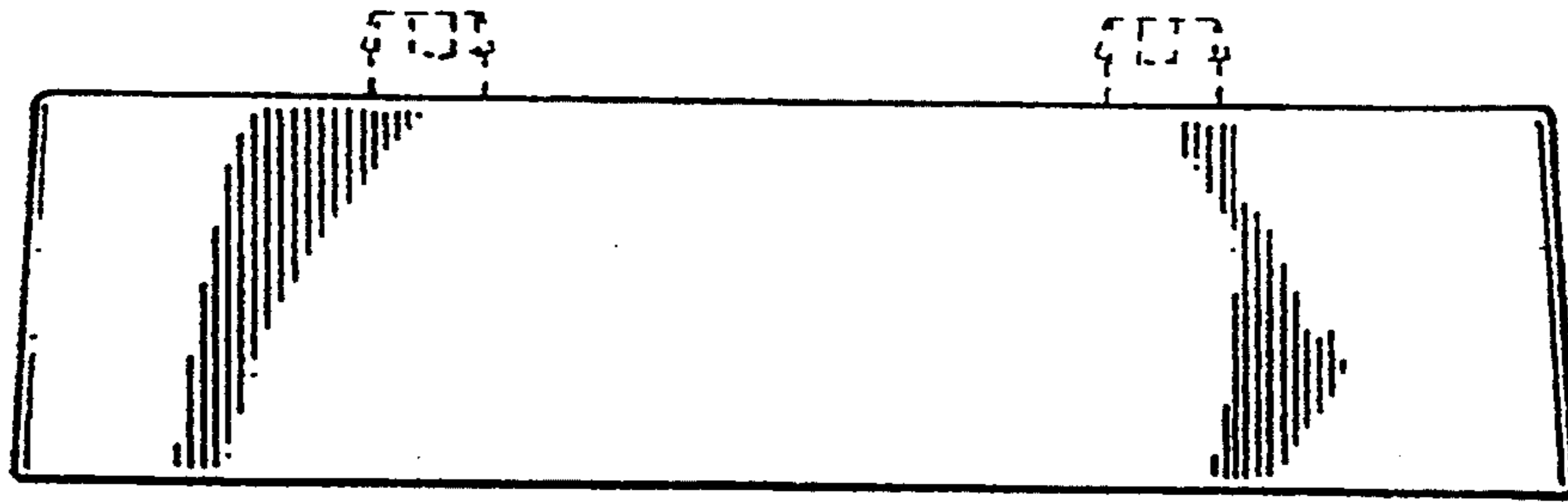

FIG. 18

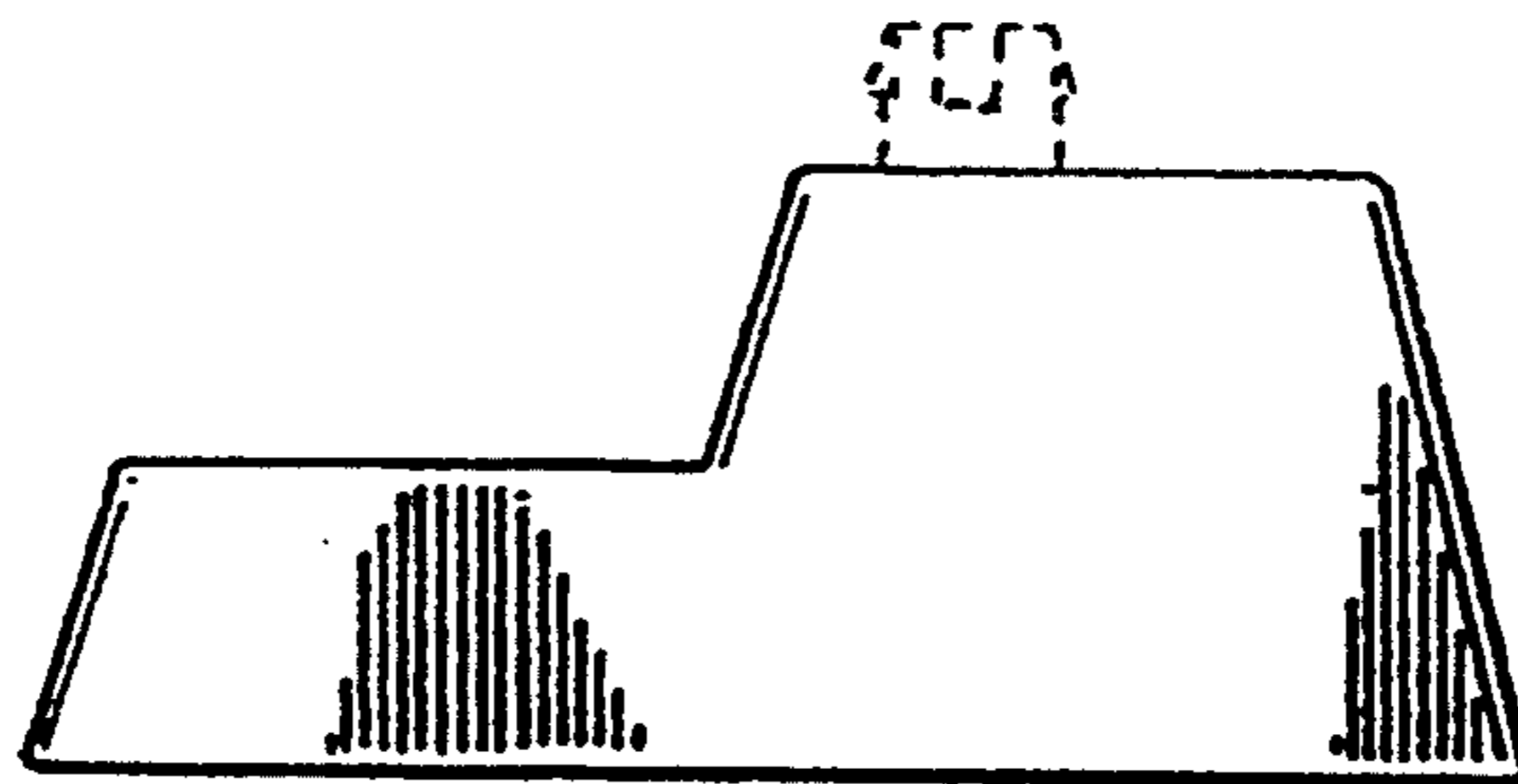

FIG. 19

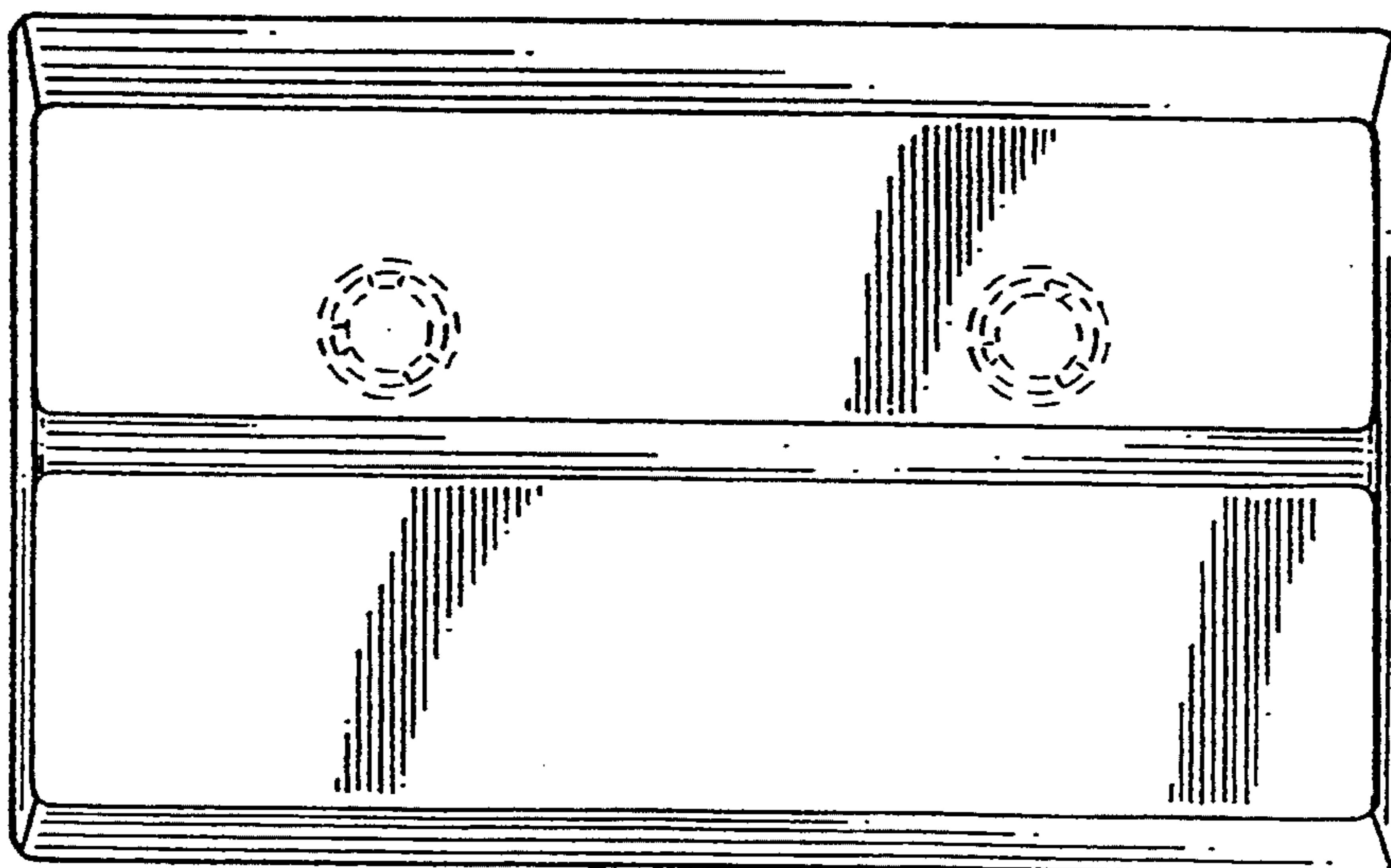

FIG. 20

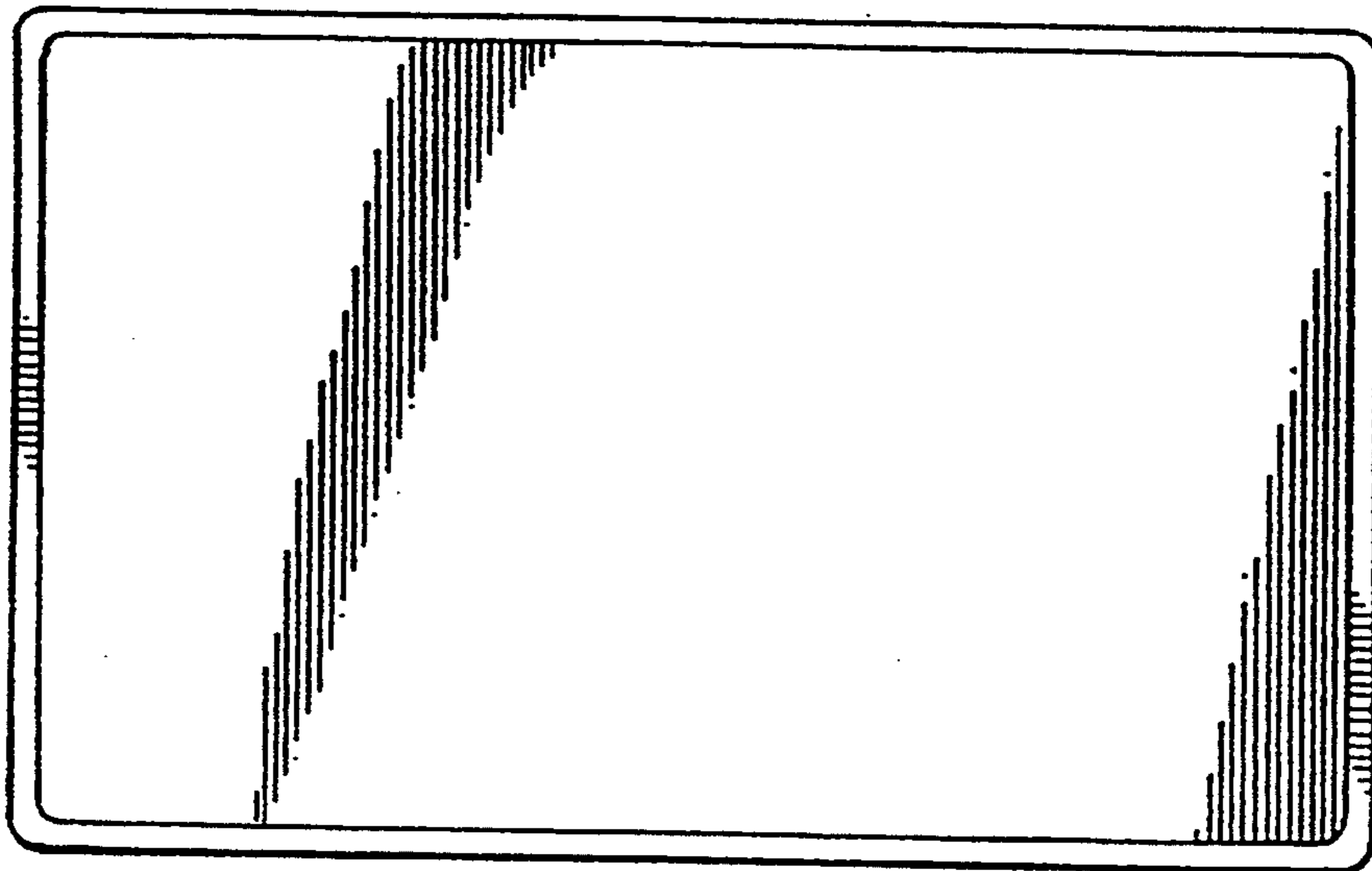

FIG. 21