



US00D353617S

# United States Patent [19]

[11] Patent Number: **Des. 353,617**

Inoue

[45] Date of Patent: **\*\* Dec. 20, 1994**

[54] **SHEET FEEDER FOR PRINTER**

[56] **References Cited**

[75] Inventor: **Manabu Inoue**, Kawasaki, Japan

**U.S. PATENT DOCUMENTS**

D. 344,750 3/1994 Sato et al. .... D18/40 X

[73] Assignee: **Canon Kabushiki Kaisha**, Tokyo, Japan

*Primary Examiner*—Alan P. Douglas  
*Assistant Examiner*—Caron D. Veynar  
*Attorney, Agent, or Firm*—Fitzpatrick, Cella, Harper & Scinto

[\*\*] Term: **14 Years**

[57] **CLAIM**

[21] Appl. No.: **952,774**

The ornamental design for a sheet feeder for printer, as shown and described.

[22] Filed: **Sep. 29, 1992**

**DESCRIPTION**

[30] **Foreign Application Priority Data**

Apr. 17, 1992 [JP] Japan ..... 4-11549

[52] U.S. Cl. .... **D18/49; D18/46**

[58] Field of Search ..... 271/3, 3.1, 8.1, 9, 271/10, 18, 116, 122, 258, 110, 111, 114, 119, 126, 147, 157, 171; 355/200, 308, 309; 358/498; D18/12, 36-44, 49, 55, 56

FIG. 1 is a front elevational view of a sheet feeder for printer showing my new design;  
FIG. 2 is a rear elevational view thereof;  
FIG. 3 is a top plan view thereof;  
FIG. 4 is a bottom plan view thereof;  
FIG. 5 is a left side elevational view thereof;  
FIG. 6 is a right side elevational view thereof; and,  
FIG. 7 is a perspective view thereof.

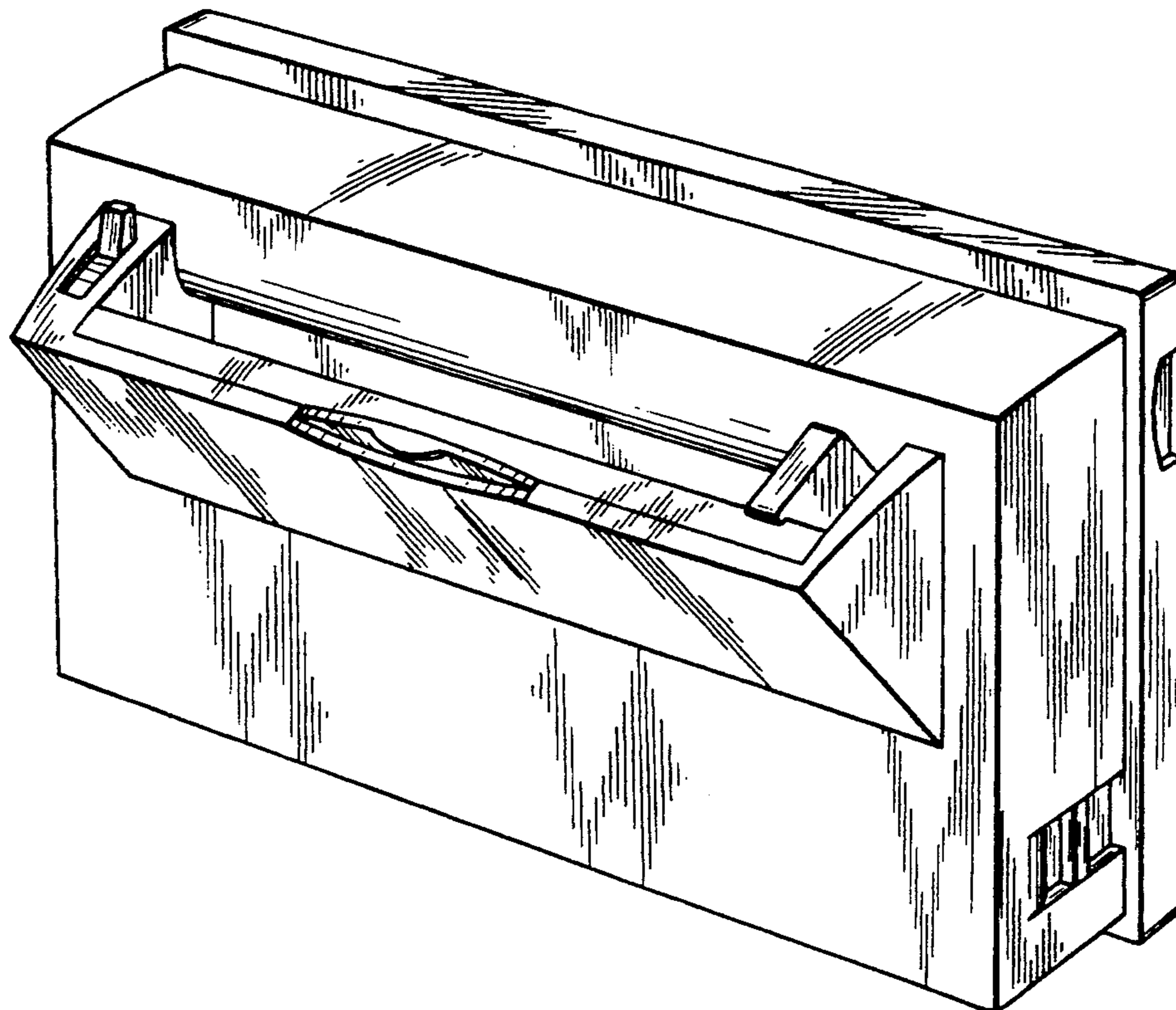

*FIG. 1*

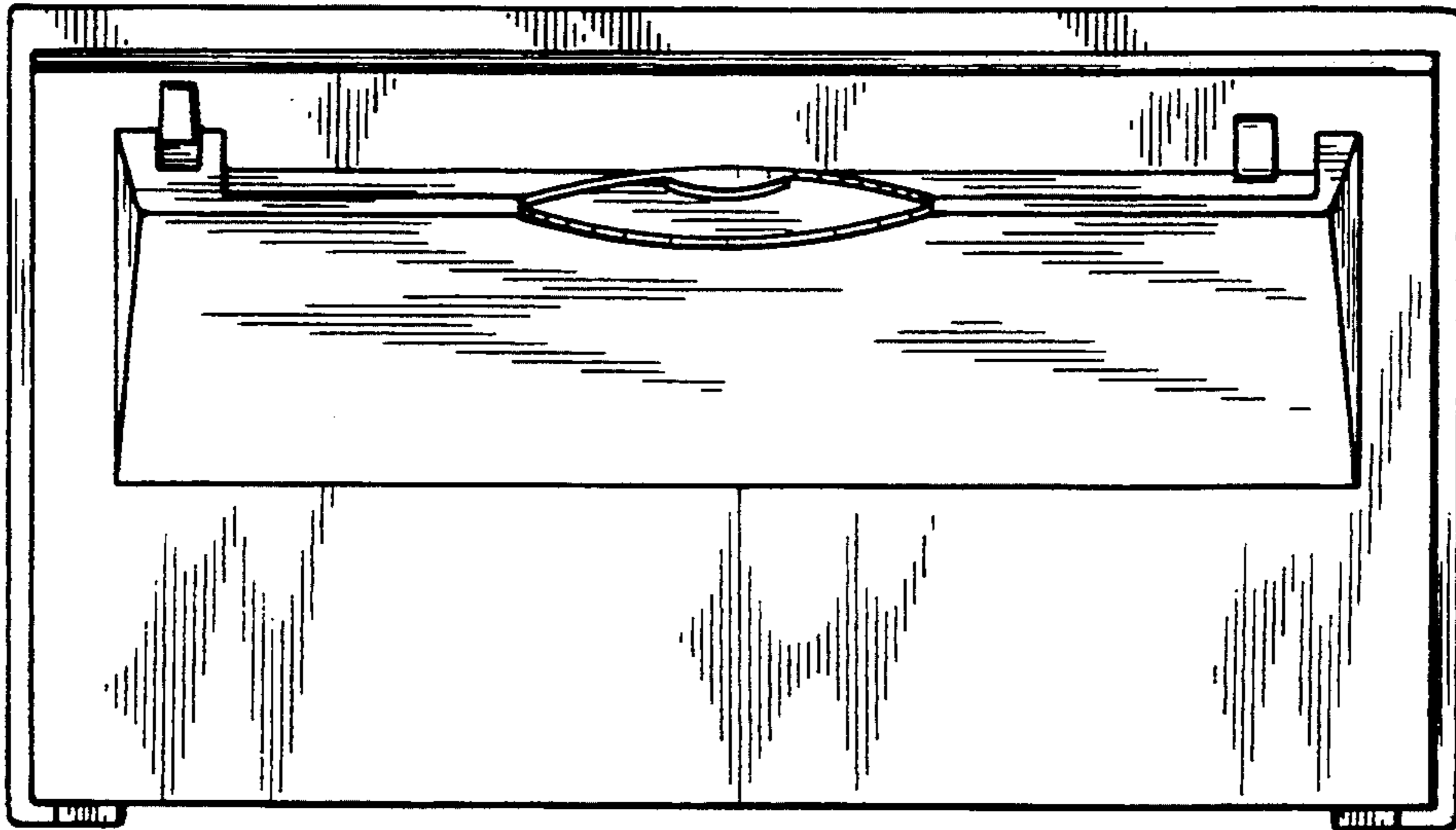

*FIG. 2*

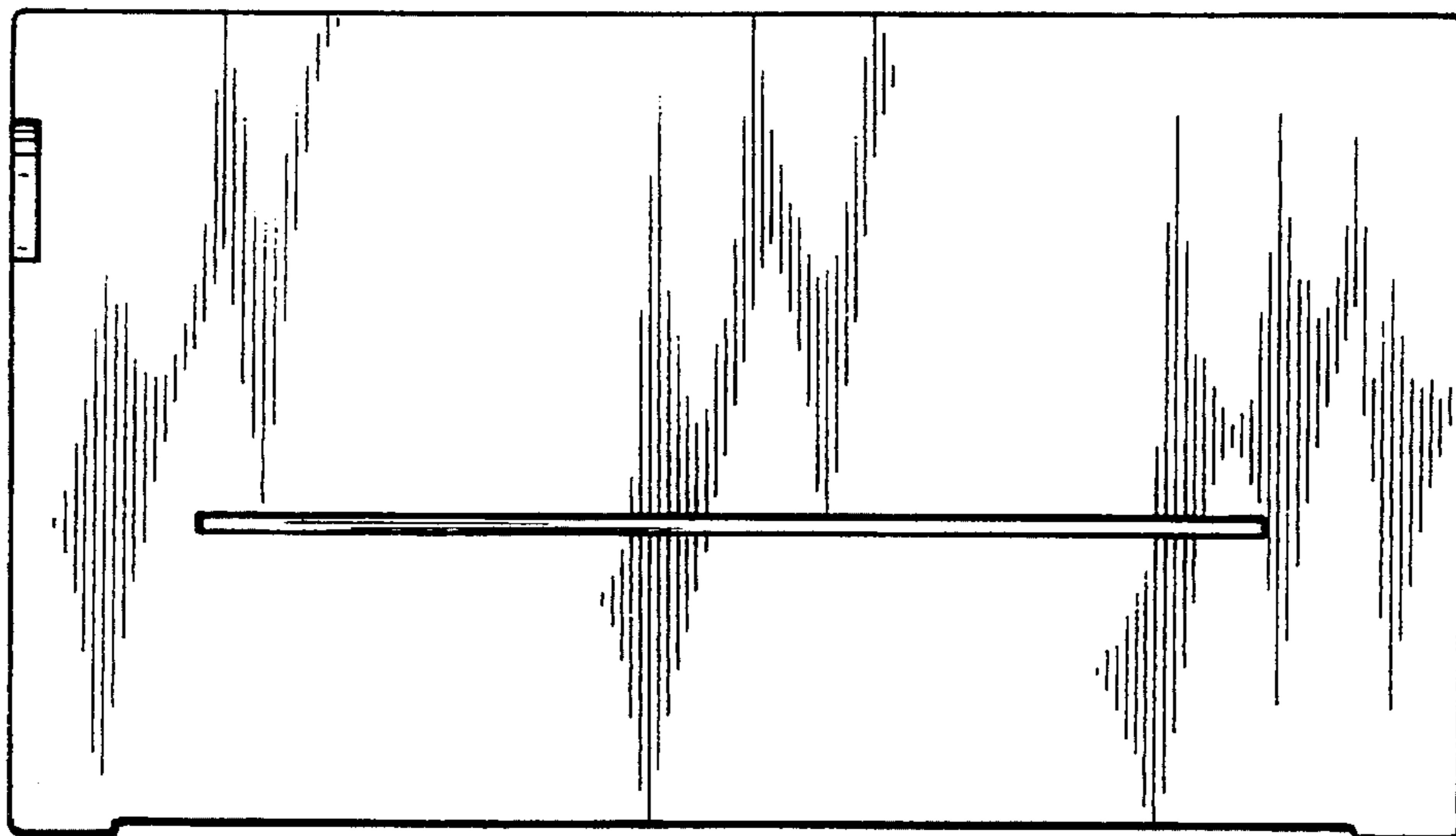

*FIG. 3*

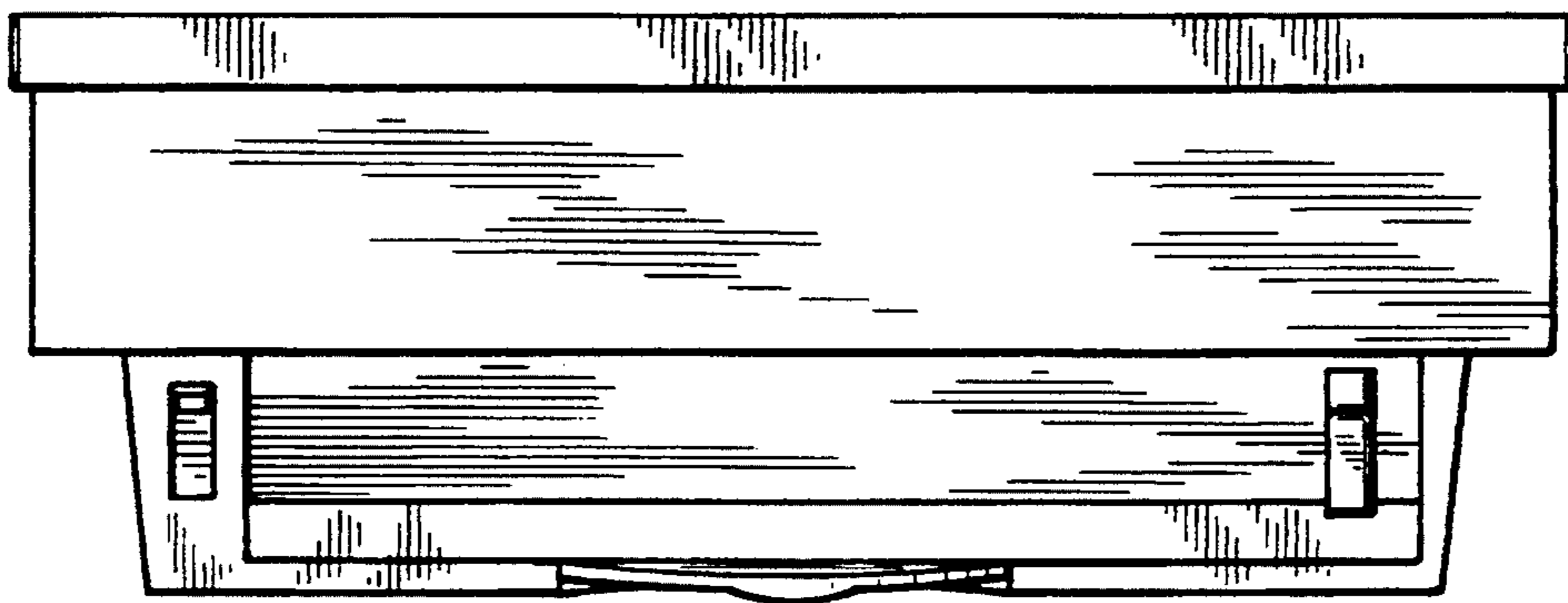

*FIG. 4*

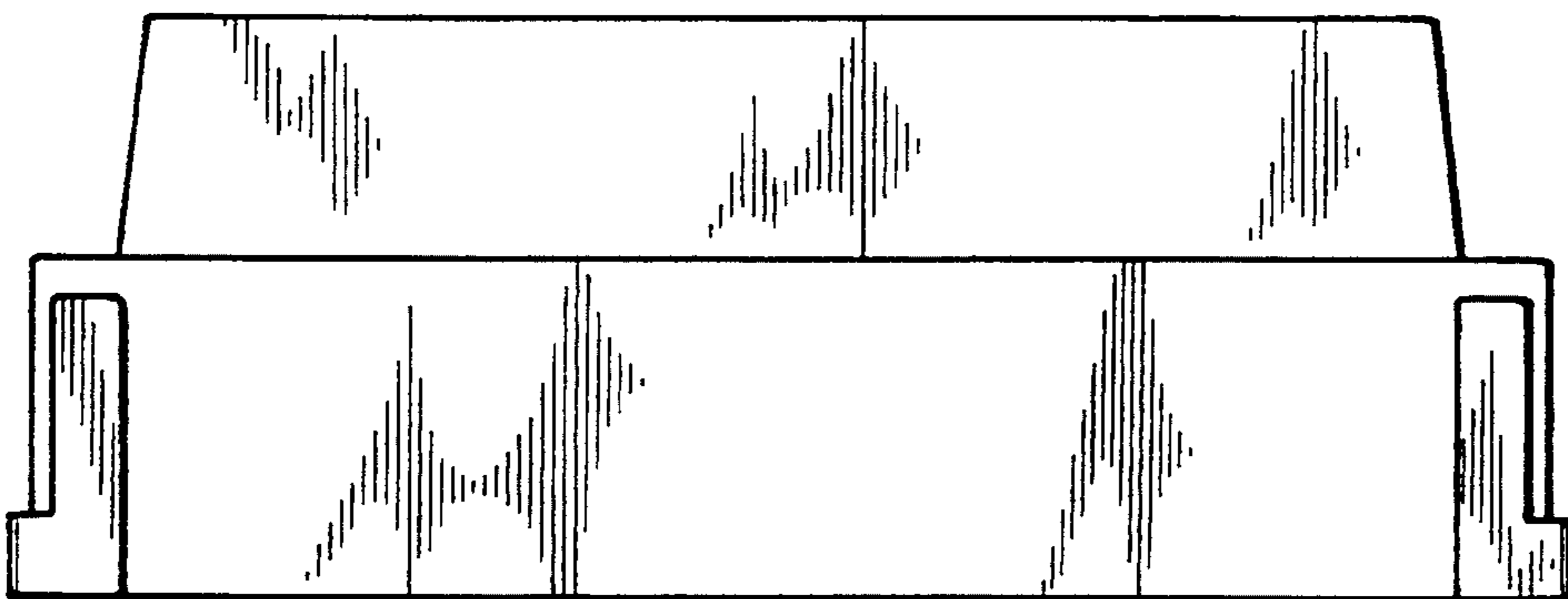

*FIG. 5*

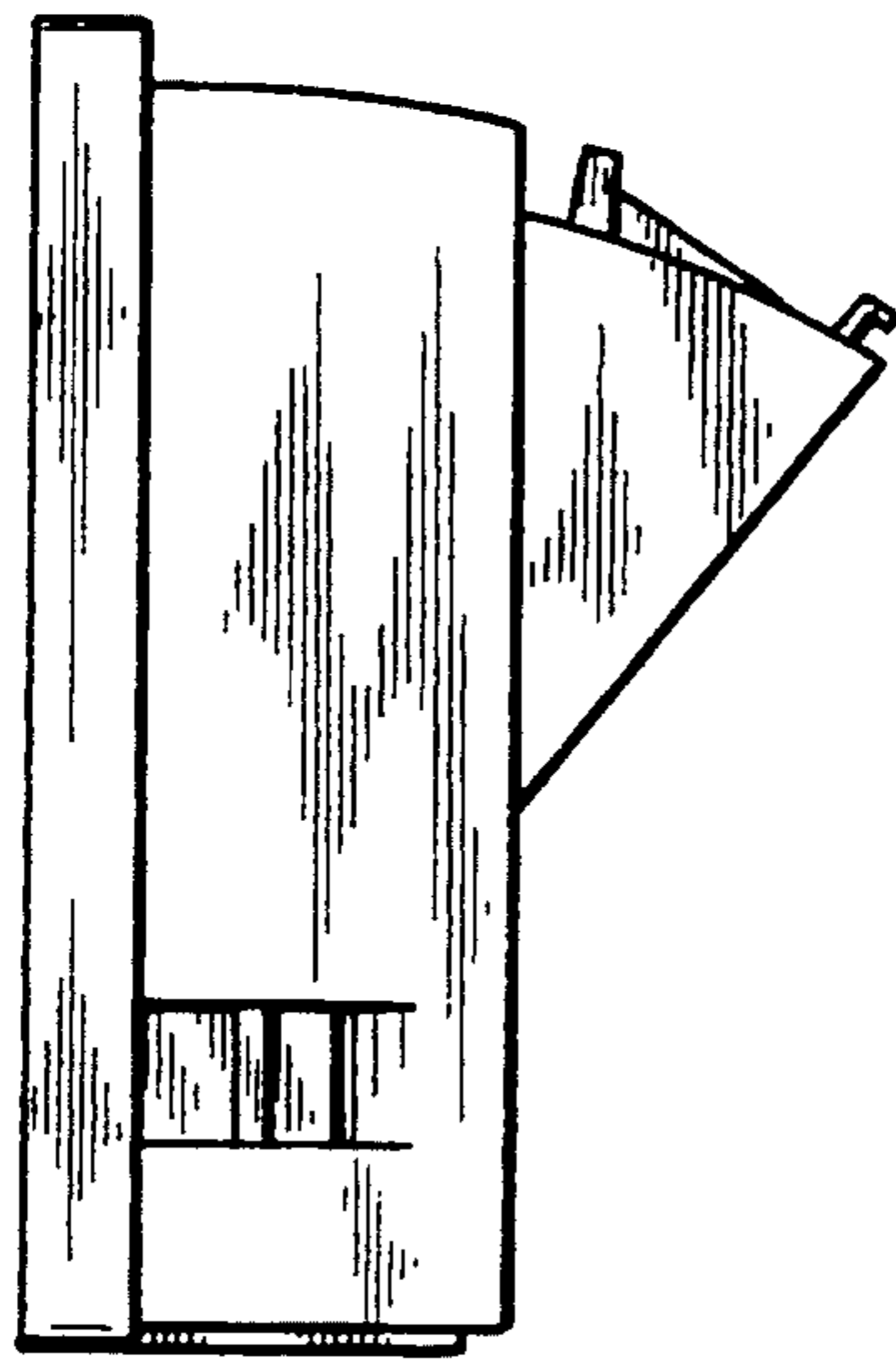

*FIG. 6*

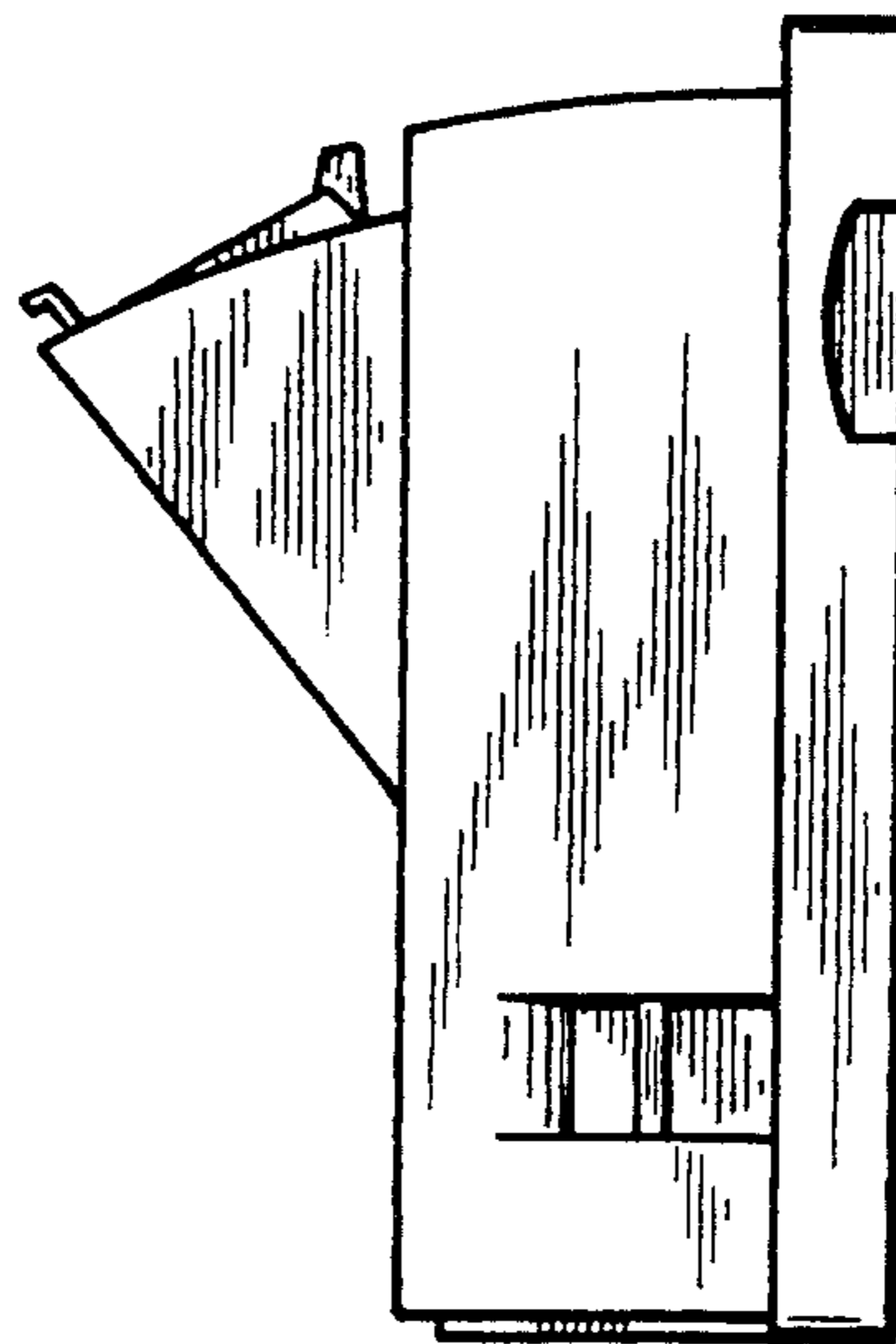

*FIG. 7*

