



US00D353613S

# United States Patent [19]

[11] Patent Number: **Des. 353,613**

Miyake et al.

[45] Date of Patent: **\*\* Dec. 20, 1994**

[54] **CASH REGISTER**

[75] Inventors: **Takao Miyake; Katsuhiko Ishida; Masayoshi Kawaishi; Yukio Kanaoka,** all of Nara, Japan

[73] Assignee: **Sharp Kabushiki Kaisha,** Osaka, Japan

[\*\*] Term: **14 Years**

[21] Appl. No.: **902,278**

[22] Filed: **Jun. 19, 1992**

[30] **Foreign Application Priority Data**

Dec. 20, 1991 [JP] Japan ..... 3-38646

[52] U.S. Cl. .... **D18/4; D18/7**

[58] Field of Search ..... 235/1 D, 1 E, 2, 4, 235/7 R, 10, 375, 379, 380, 419, 145; 364/404, 405; D18/1, 2, 4, 6, 7, 11; D14/100, 105, 106, 115

[56] **References Cited**

**U.S. PATENT DOCUMENTS**

D. 175,356 8/1955 Koons ..... D18/7  
D. 217,911 6/1970 Herold ..... D18/6

D. 233,440 10/1974 Fossella et al. .... D18/7  
D. 279,108 6/1985 Sawada ..... D18/7  
D. 301,589 6/1989 Makidera ..... D18/4  
D. 303,395 9/1989 Tsukada et al. .... D18/4

*Primary Examiner*—Alan P. Douglas  
*Assistant Examiner*—Caron D. Veynar  
*Attorney, Agent, or Firm*—Nixon & Vanderhye

[57] **CLAIM**

The ornamental design for a cash register, as shown and described.

**DESCRIPTION**

FIG. 1 is a top, left and front perspective view of a cash register showing our new design, the keypad keys being continuous over the span indicated by the dot-dash lines for ease of illustration;  
FIG. 2 is a top plan view thereof;  
FIG. 3 is a bottom plan view thereof;  
FIG. 4 is a front elevational view thereof;  
FIG. 5 is a rear elevational view thereof;  
FIG. 6 is a right side elevational view thereof;  
FIG. 7 is a left side elevational view thereof; and,  
FIG. 8 is a perspective view similar to FIG. 1 illustrating the customer display in an alternate position.

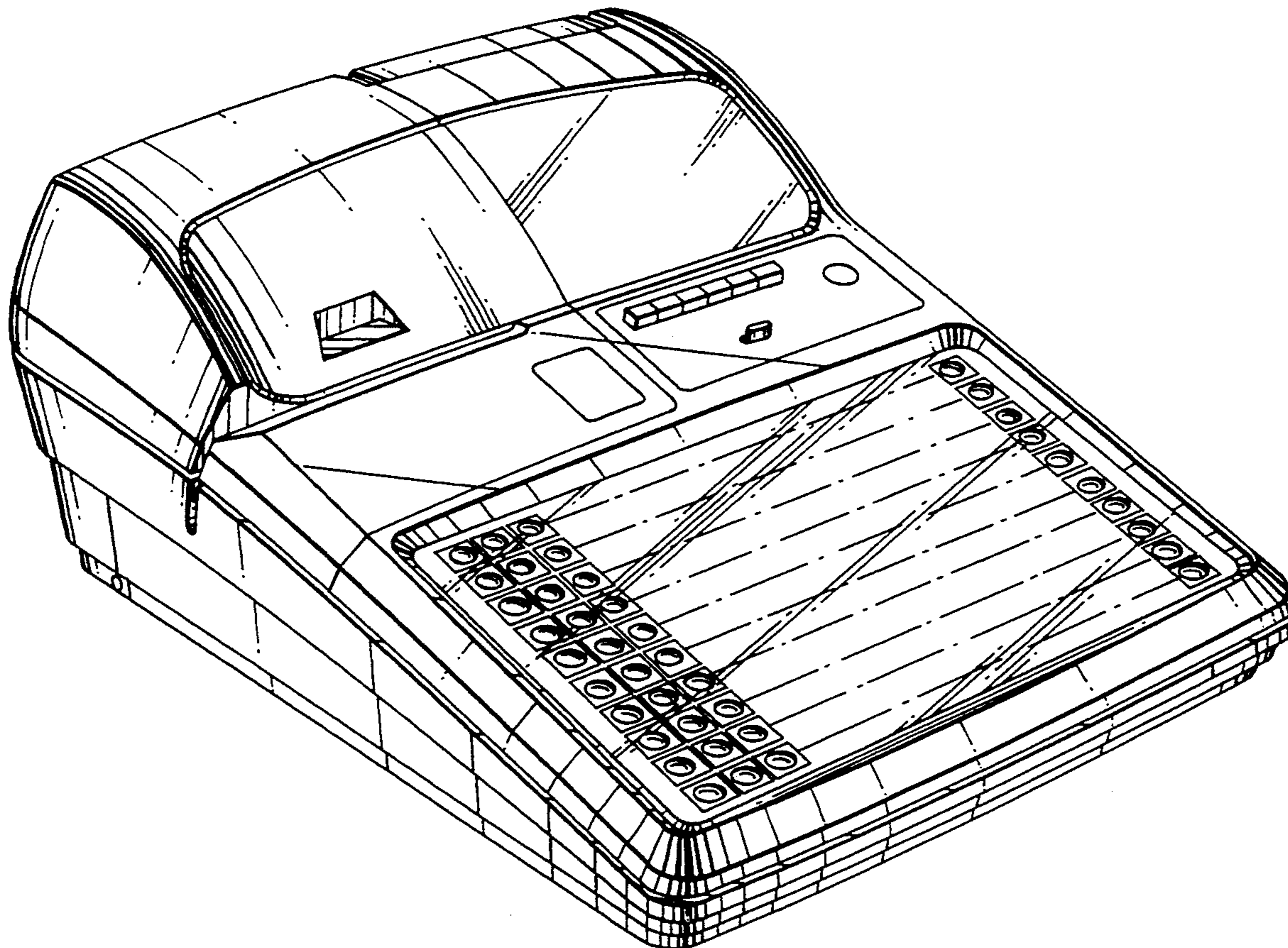

**FIG. 1**

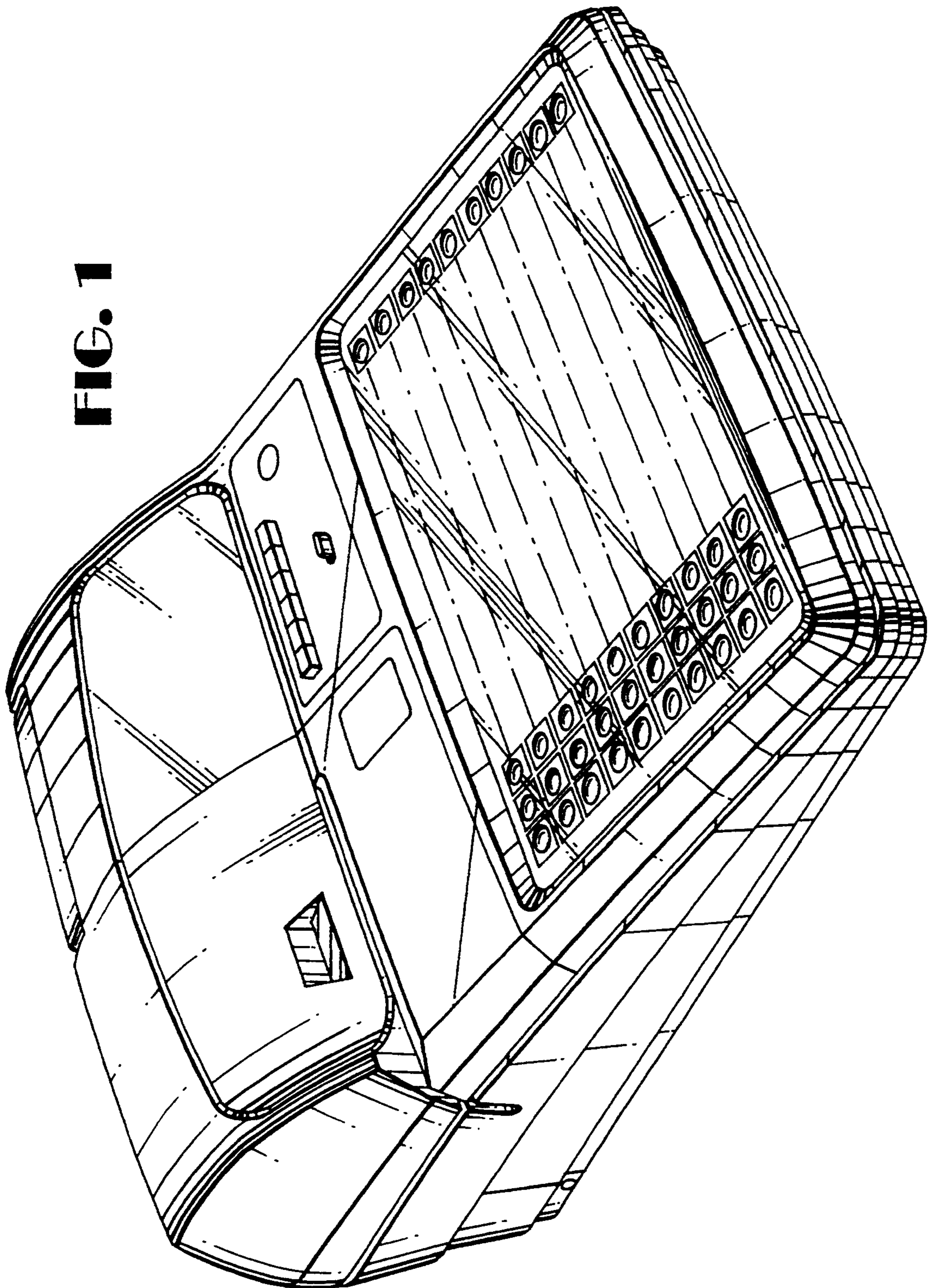

FIG. 3

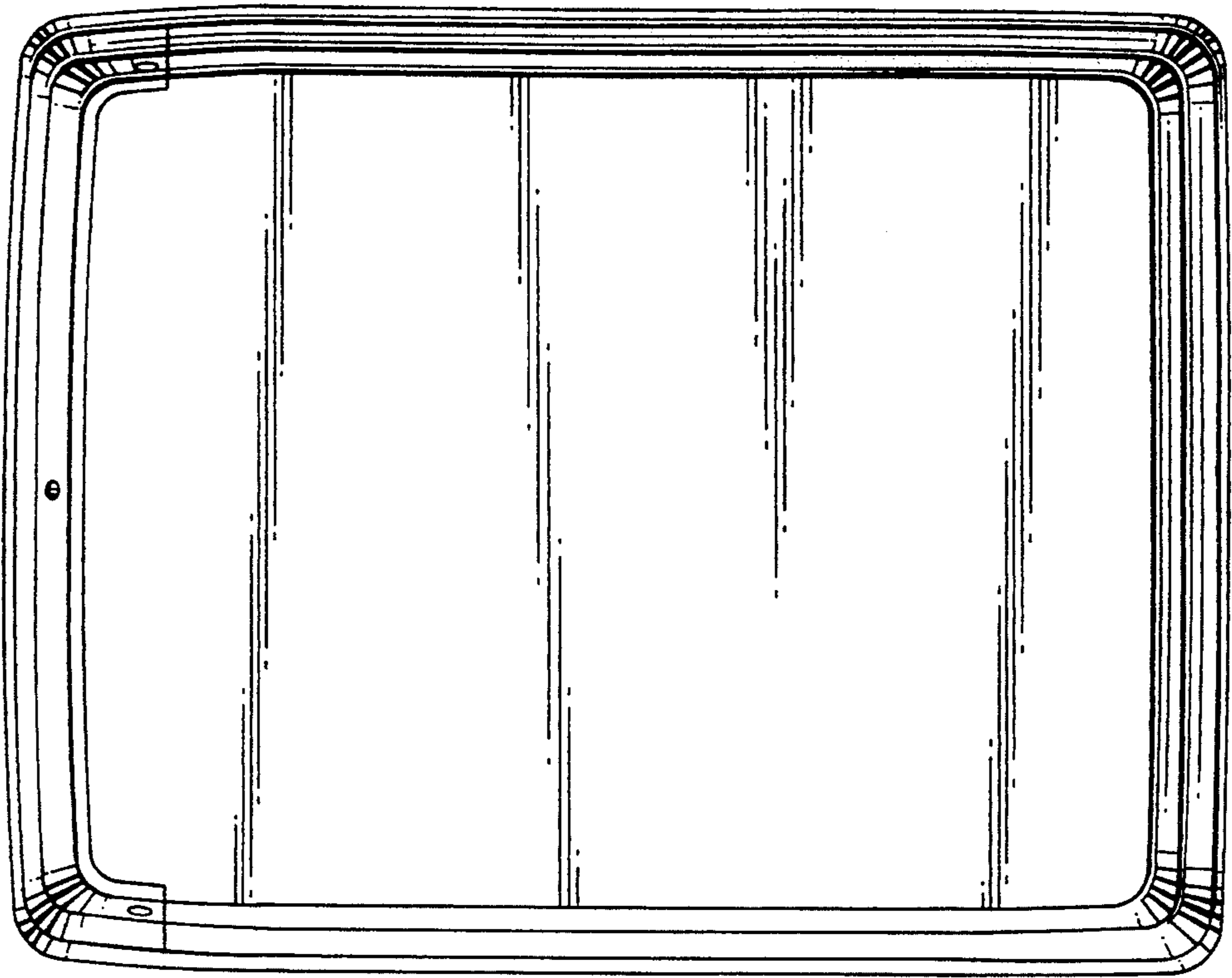
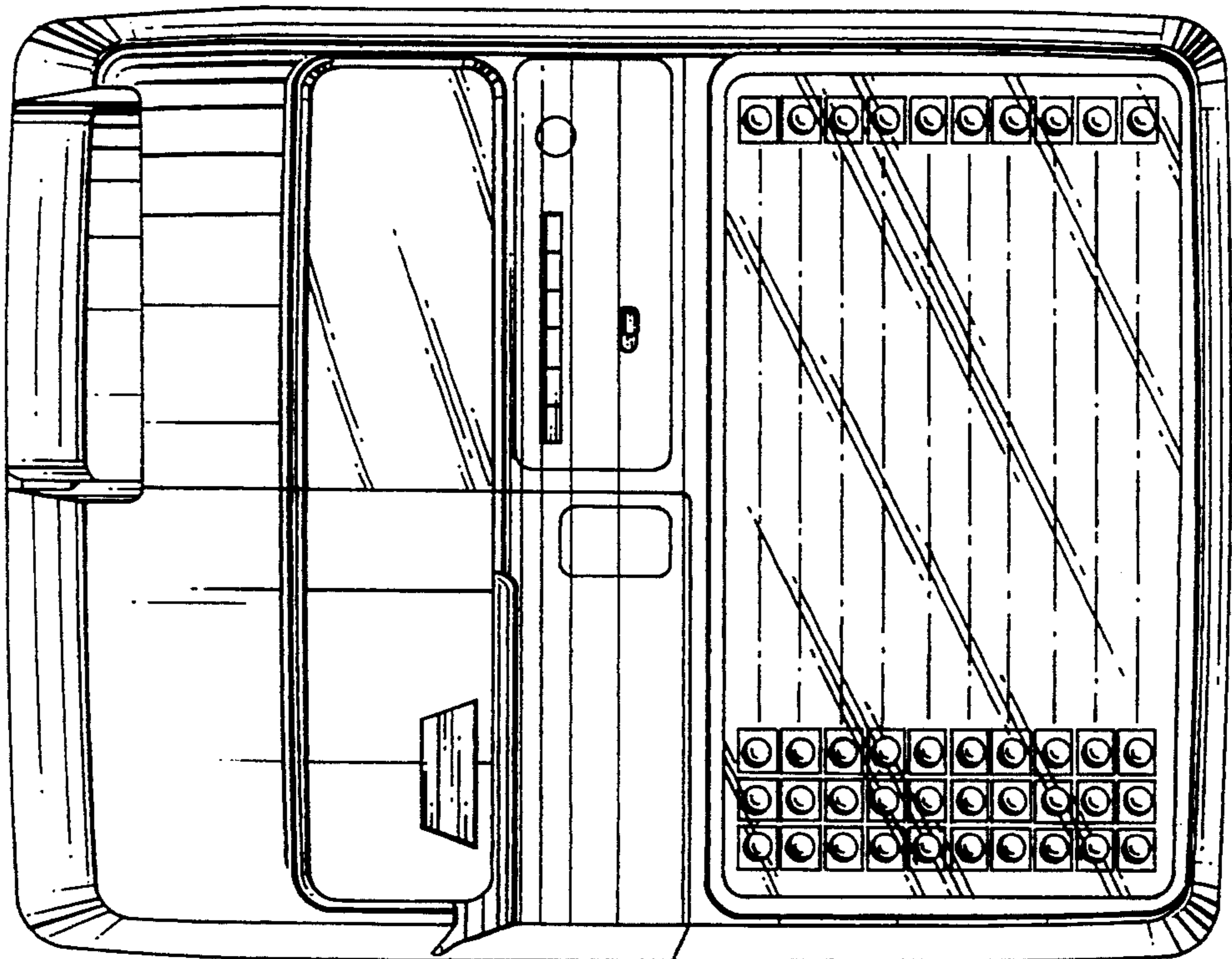
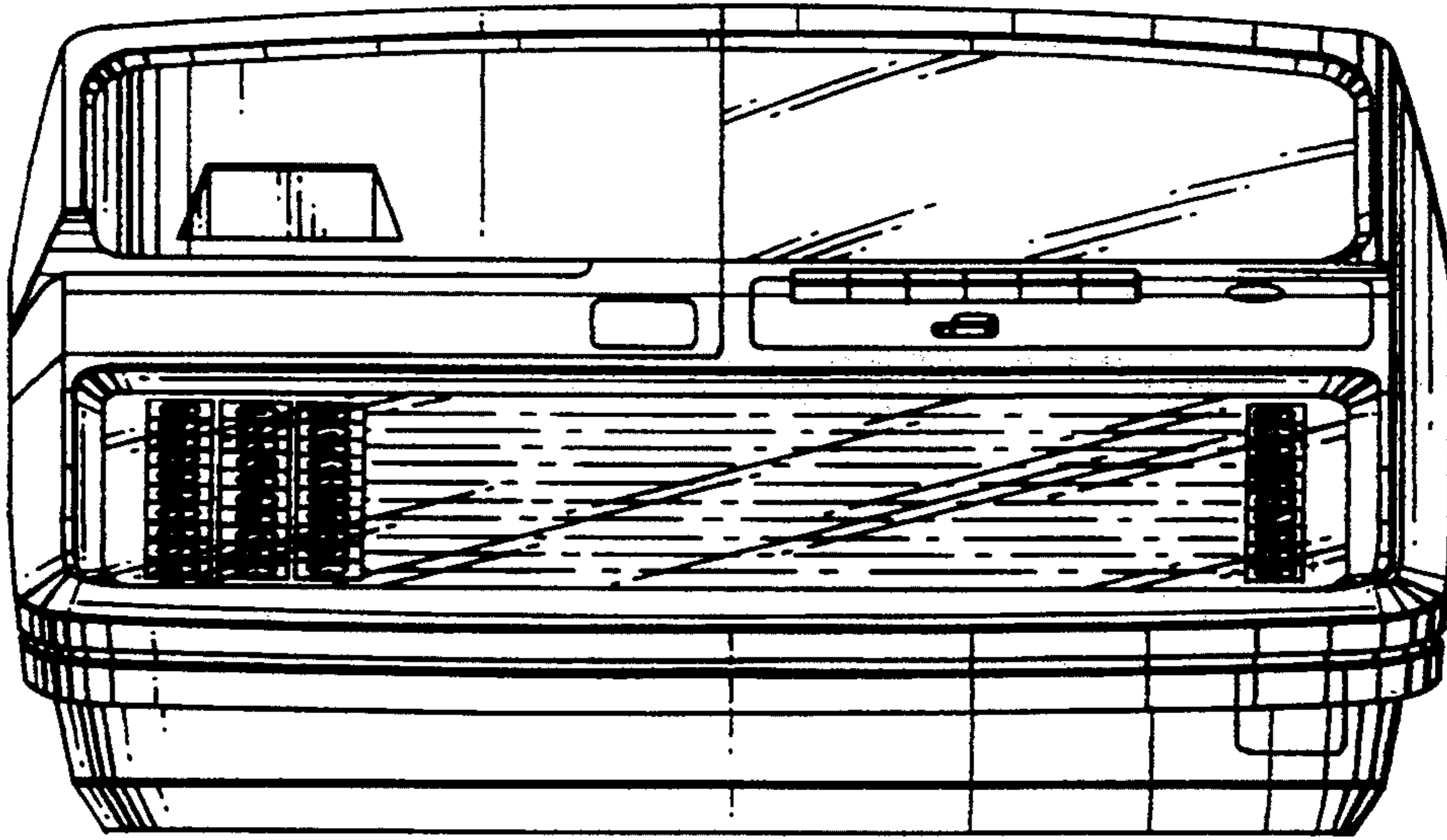

FIG. 2



**FIG. 4**



**FIG. 5**

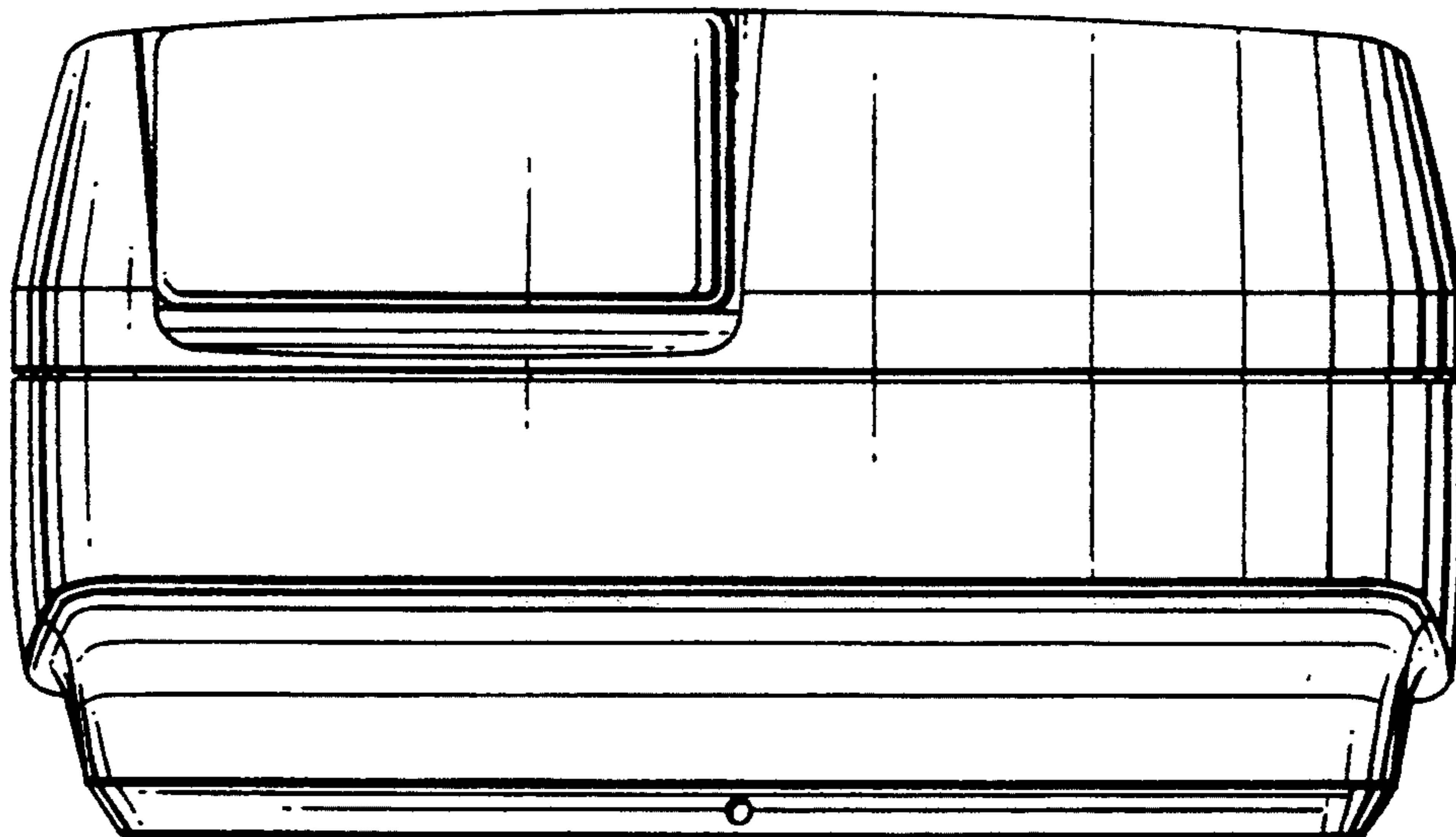

**FIG. 6**

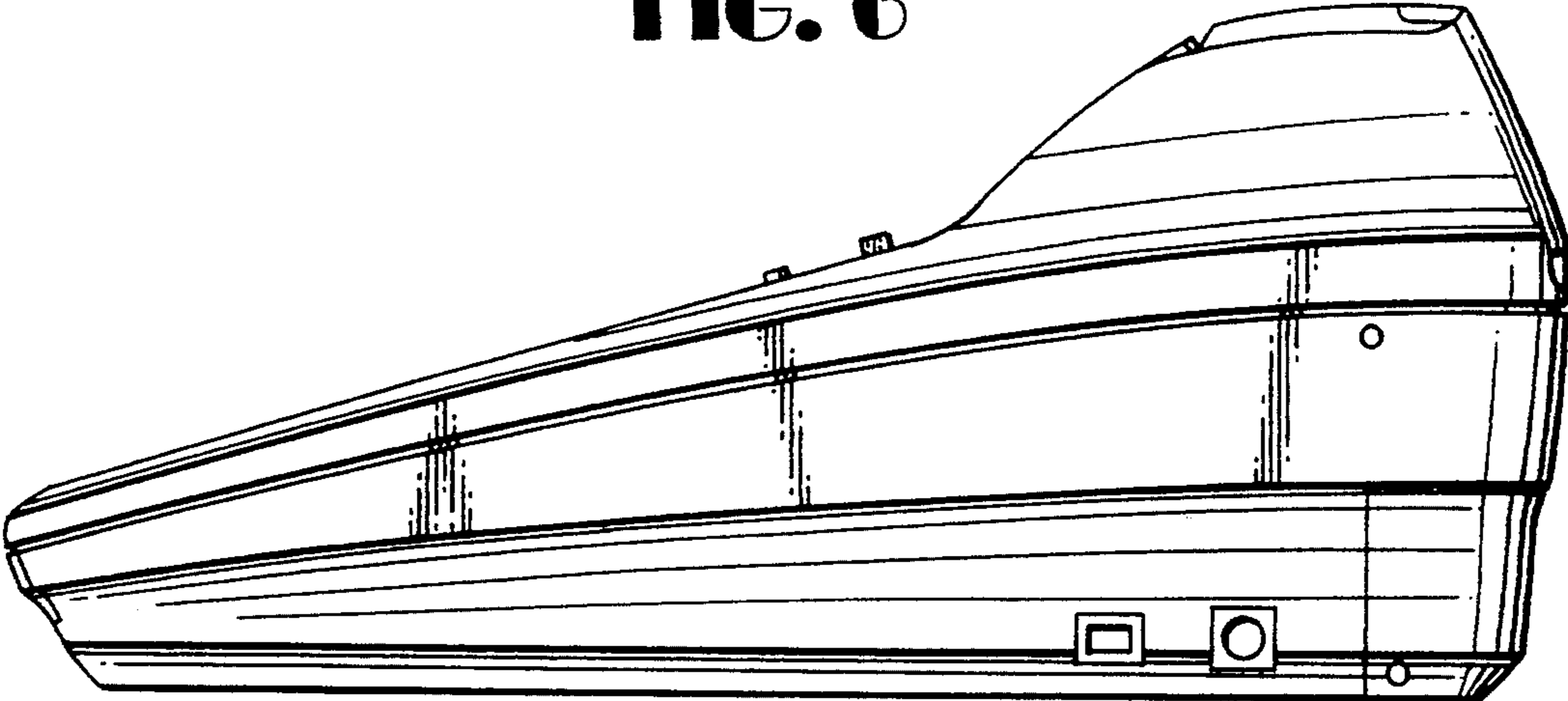

**FIG. 7**

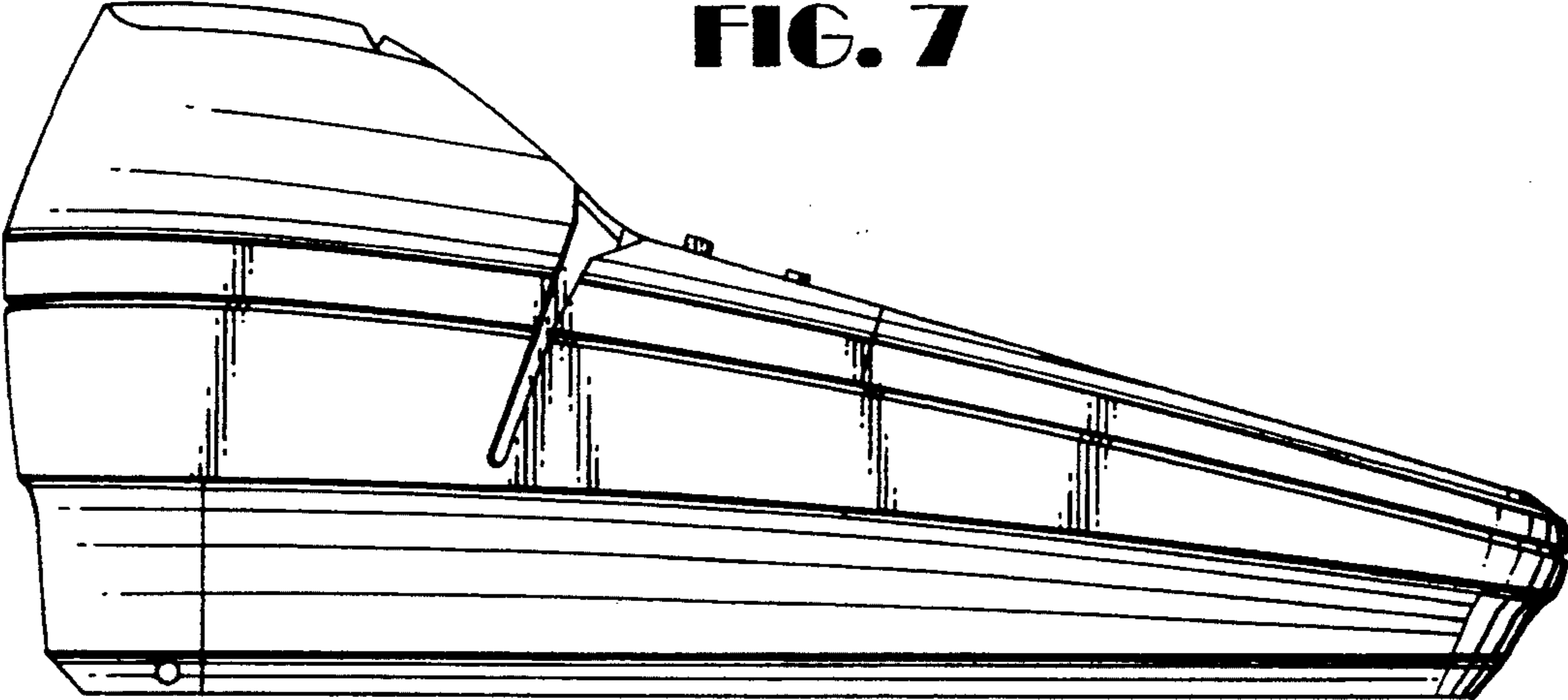

**FIG. 8**

