



US00D353534S

United States Patent [19]

[11] Patent Number: **Des. 353,534**

Eizen

[45] Date of Patent: **** Dec. 20, 1994**

[54] **KEY BLANK**

[75] Inventor: **Noach Eizen, Rishon Lezion, Israel**

[73] Assignee: **Mul-T-Lock Ltd., Yavne, Israel**

[*] Notice: The portion of the term of this patent subsequent to May 4, 2007 has been disclaimed.

[**] Term: **14 Years**

[21] Appl. No.: **826,159**

[22] Filed: **Jan. 22, 1992**

[52] U.S. Cl. **D8/347**

[58] Field of Search **D8/347-348;**
70/353, 402, 405-407, 437

[56] **References Cited**

U.S. PATENT DOCUMENTS

D. 283,978 5/1986 Mills **D8/347**

D. 330,845 10/1992 Best et al. **D8/347**
D. 335,253 5/1993 Eizen **D8/347**
D. 278,880 5/1985 Widén **D8/347**
2,803,959 8/1957 Schlage **70/437 X**
4,787,225 11/1988 Hanser **70/407 X**

Primary Examiner—Brian N. Vinson
Attorney, Agent, or Firm—Abelman, Frayne & Schwab

[57] **CLAIM**

The ornamental design for a key blank, as shown and described.

DESCRIPTION

FIG. 1 is a front view of the key blank of my design; FIG. 2 is a rear view thereof; FIG. 3 is a left-side view thereof; FIG. 4 is a right-side view thereof; FIG. 5 is a plan view thereof; FIG. 6 is an underside plan view thereof; and, FIG. 7 is a transverse cross-section thereof taken on the line VII—VII in FIG. 1.

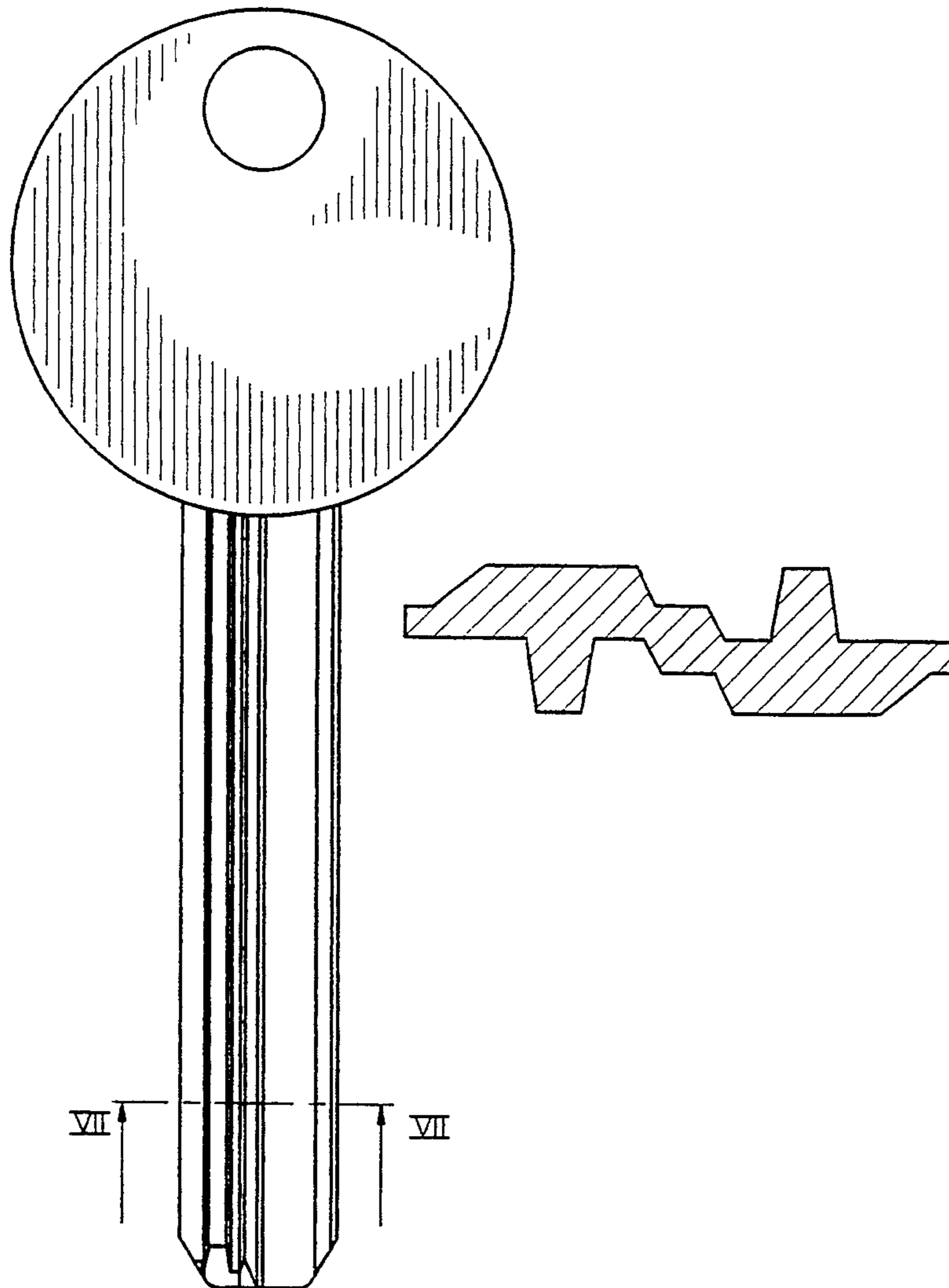

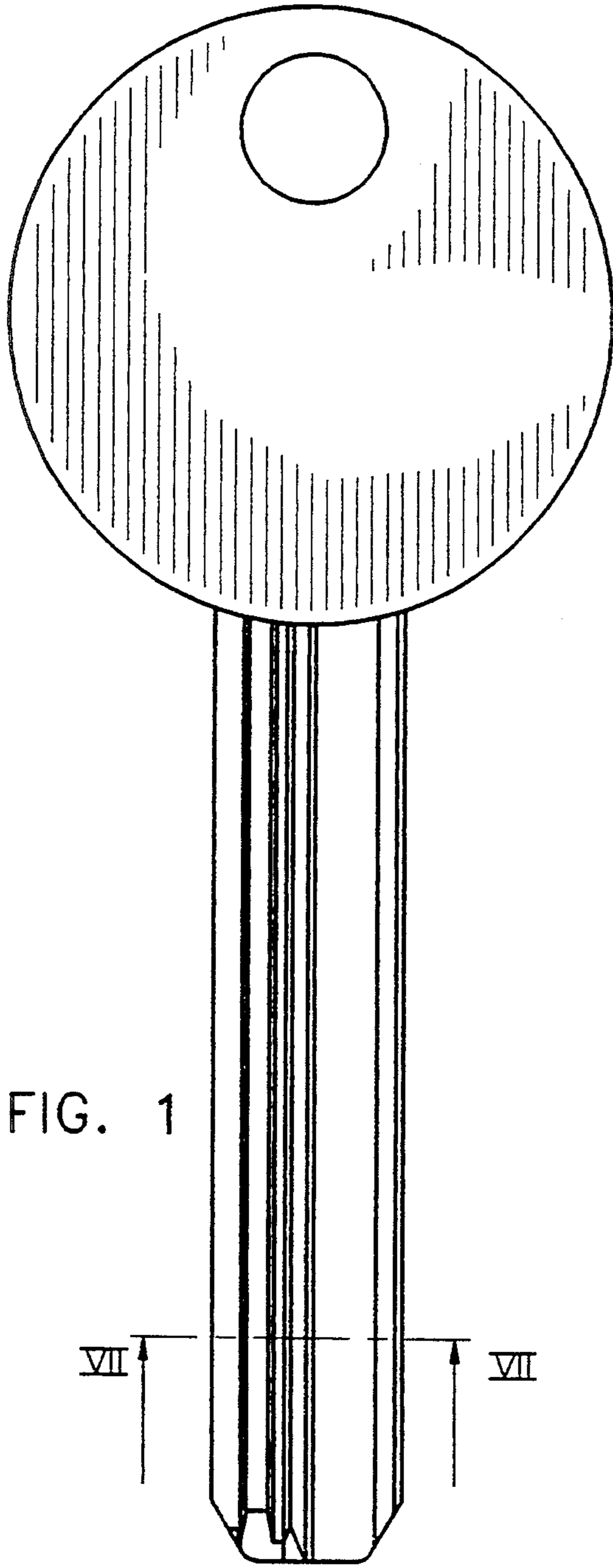

FIG. 1

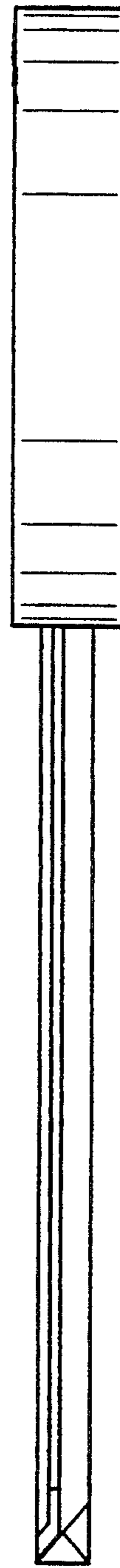

FIG. 3



FIG. 5

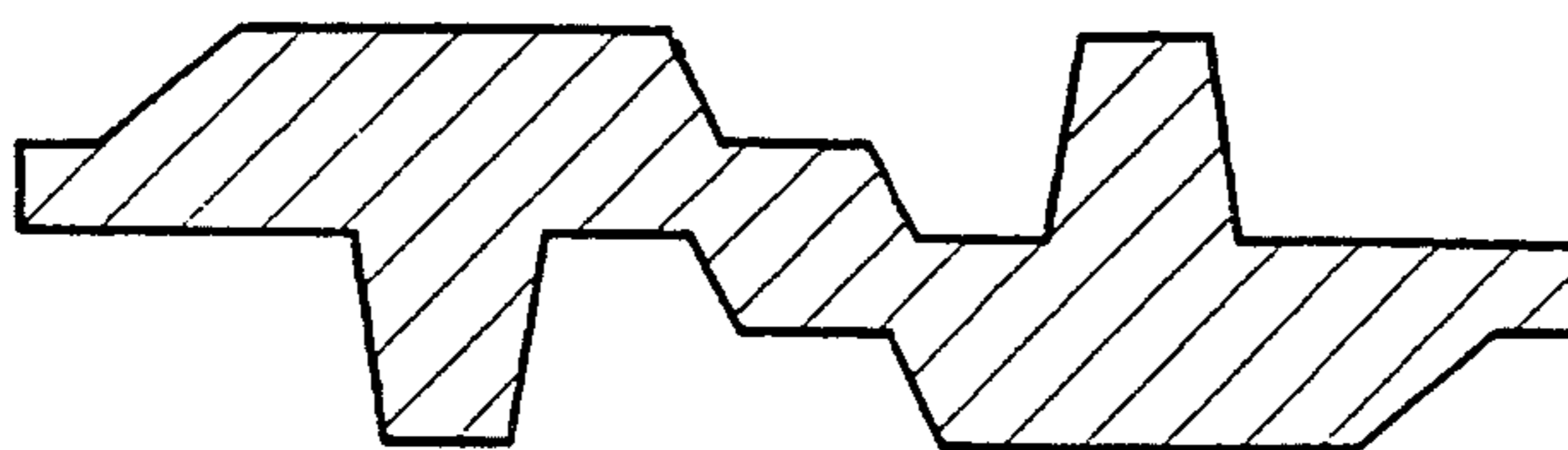

FIG. 7

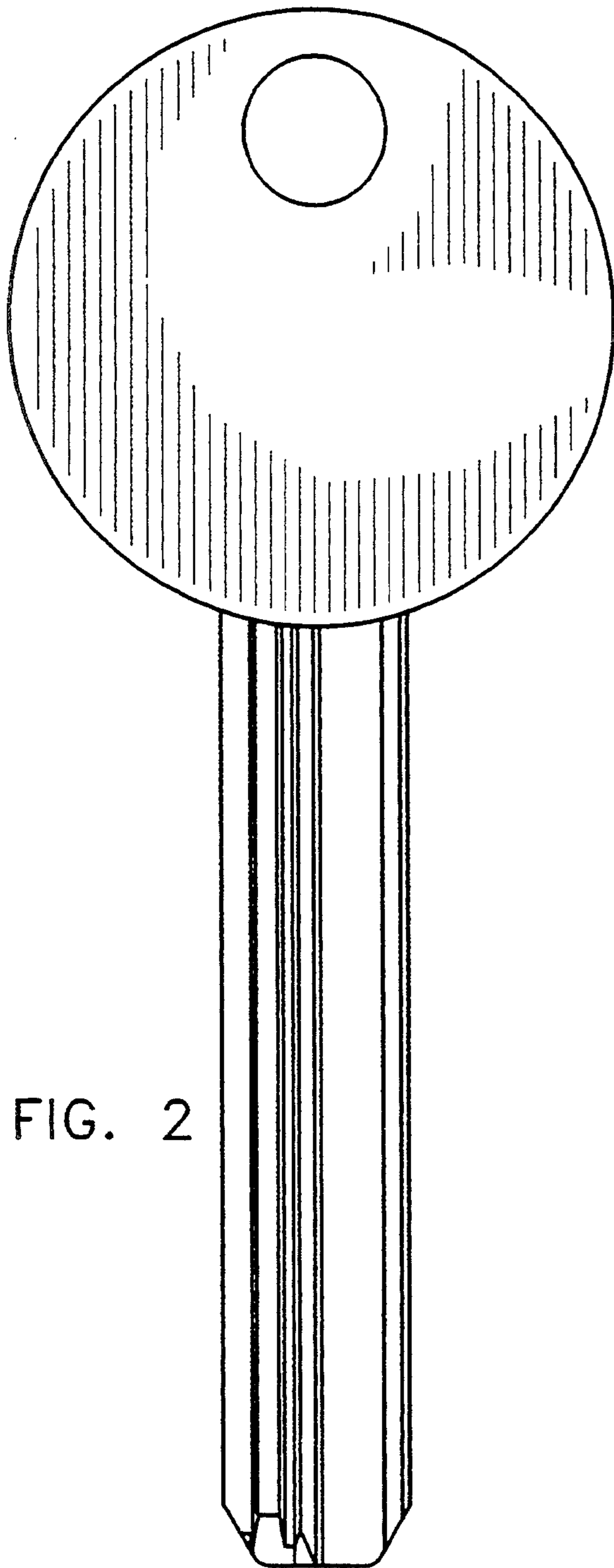

FIG. 2

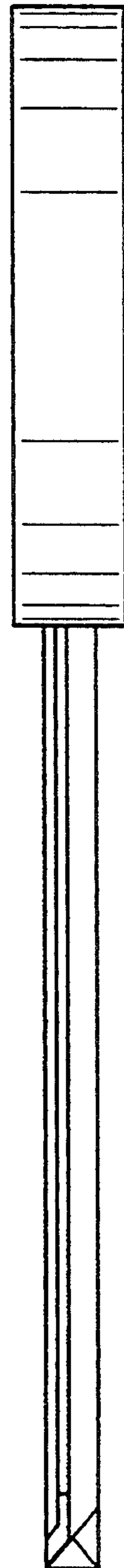

FIG. 4

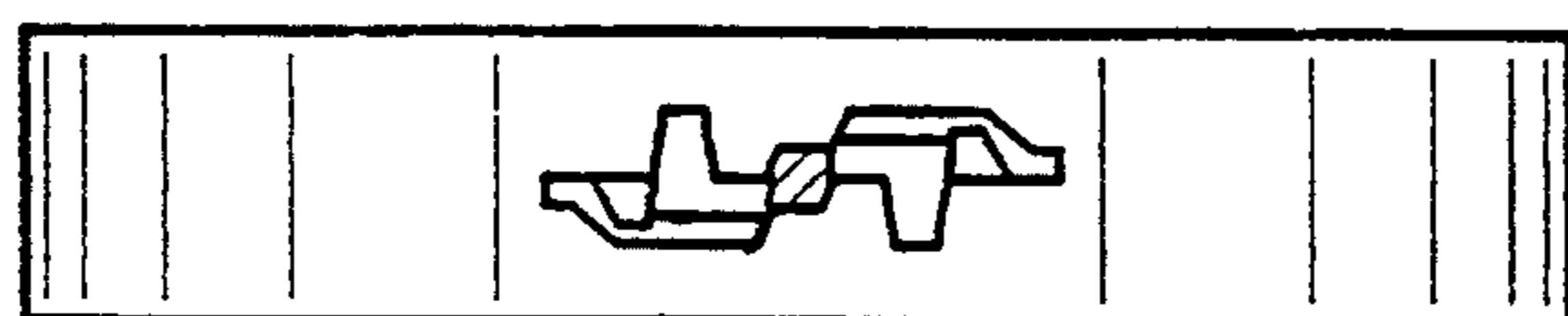

FIG. 6