



US00D353508S

United States Patent [19]

[11] Patent Number: **Des. 353,508**

Sankey et al.

[45] Date of Patent: **** Dec. 20, 1994**

[54] STORAGE CONTAINER FOR RECORDING MEDIA

[75] Inventors: **James K. Sankey**, Hudson;
Christopher G. Gallagher, Akron;
Todd M. Bradford, Marshallville, all of Ohio

[73] Assignee: **Alpha Enterprises, Inc.**, North Canton, Ohio

[**] Term: **14 Years**

[21] Appl. No.: **3,947**

[22] Filed: **Jan. 22, 1993**

[52] U.S. Cl. **D6/631; D6/407; D6/632**

[58] Field of Search **D3/249; D6/407, 448, D6/468, 626, 627, 628, 629, 630, 631, 632, 633, 634, 635; D9/424, 425; 206/45.23, 309, 311, 387, 312, 444; D19/75, 76**

[56] **References Cited**

U.S. PATENT DOCUMENTS

D. 230,527	2/1974	Berkman	D6/631
D. 249,823	10/1978	Berkman	D6/631
D. 257,496	11/1980	Berkman	D6/631
D. 259,450	6/1981	Velarud	D6/407
D. 293,279	12/1987	Evans	D19/76
D. 293,625	1/1988	Bankier	D19/76
D. 308,340	6/1990	Ilsen et al.	D9/425
D. 326,357	5/1992	Chow	D3/35

D. 330,329	10/1992	Brightbill	D9/425
D. 330,975	11/1992	Stafford	D6/631
3,330,120	10/1992	Temple et al.	D6/407
3,383,009	5/1968	Weikert	D9/425
4,629,066	12/1986	Howard	206/387

Primary Examiner—A. Hugo Word
Assistant Examiner—Celia A. Murphy
Attorney, Agent, or Firm—Michael Sand Co.

[57] **CLAIM**

The ornamental design for an storage container for recording media, as shown and described.

DESCRIPTION

FIG. 1 is a perspective view of an storage container for recording media with cover showing our new design; FIG. 2 is a right side elevation of the container with the cover, the left side elevation being a mirror image; FIG. 3 is a front elevational view thereof with cover; FIG. 4 is a right side elevation similar to FIG. 2 without the cover; FIG. 5 is a front view similar to FIG. 3 without the cover; FIG. 6 is a rear elevation of the container without the cover; FIG. 7 is a top plan view without the cover; FIG. 8 is a rear elevation without the cover; FIG. 9 is a front elevational view of the cover thereof; FIG. 10 is a rear elevational of the cover; FIG. 11 is a right side elevation of the cover, the left side elevation being a mirror image; and, FIG. 12 is a top plan view of the cover.

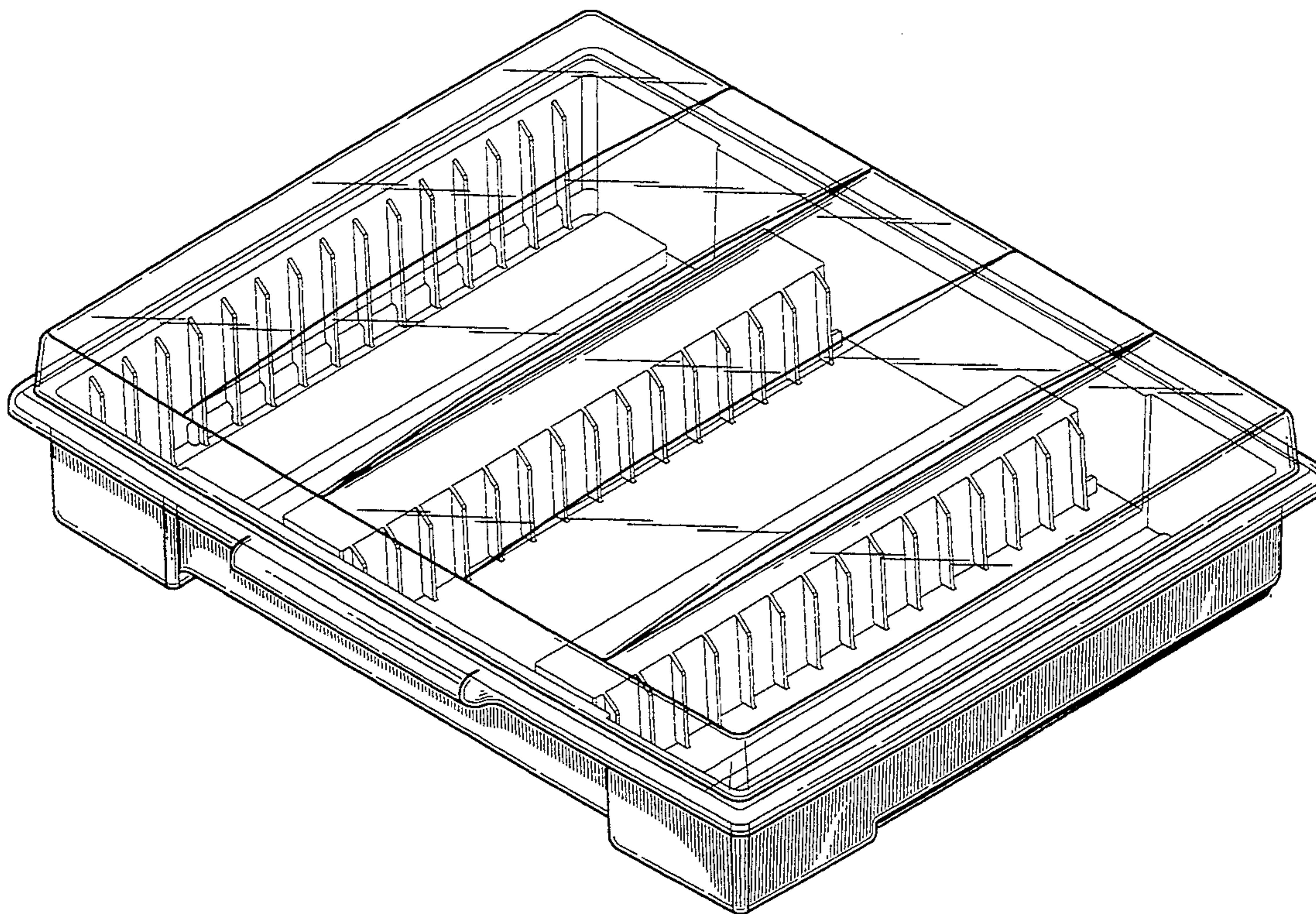

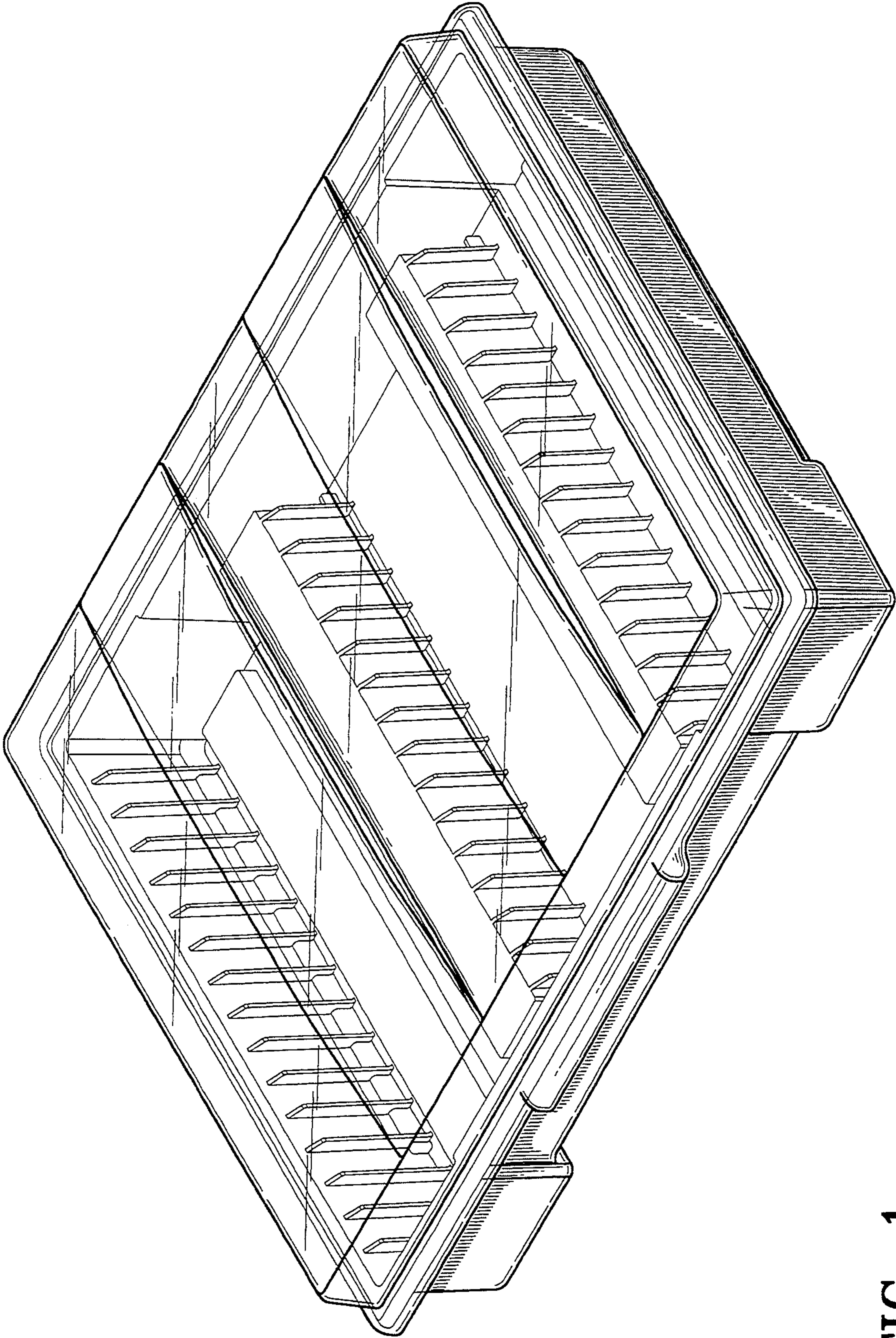

FIG-1

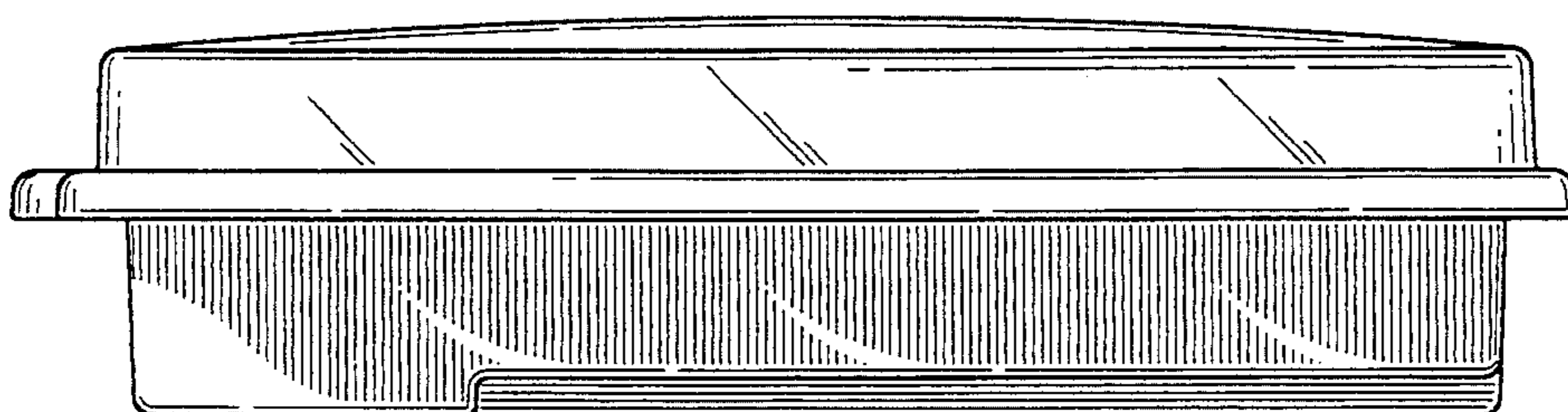

FIG-2

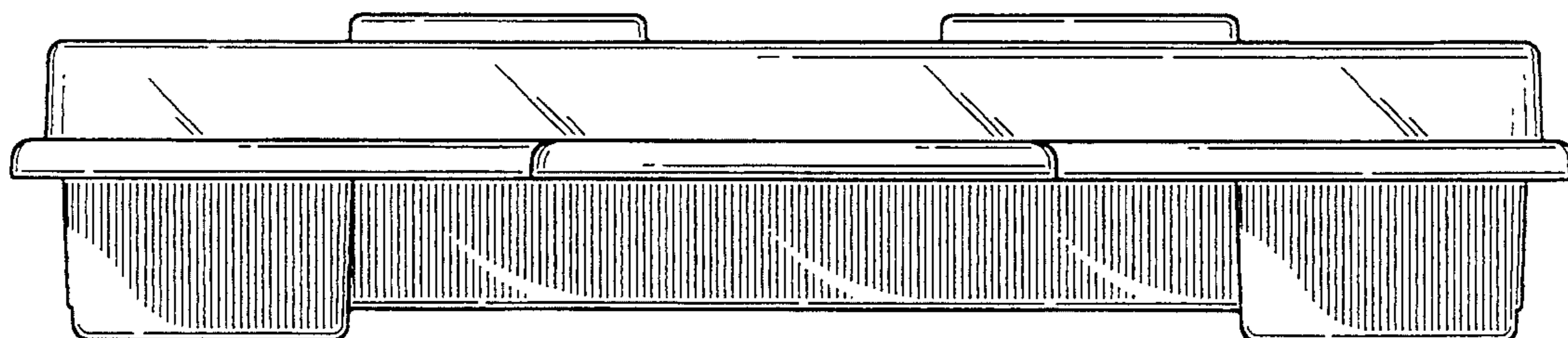

FIG-3

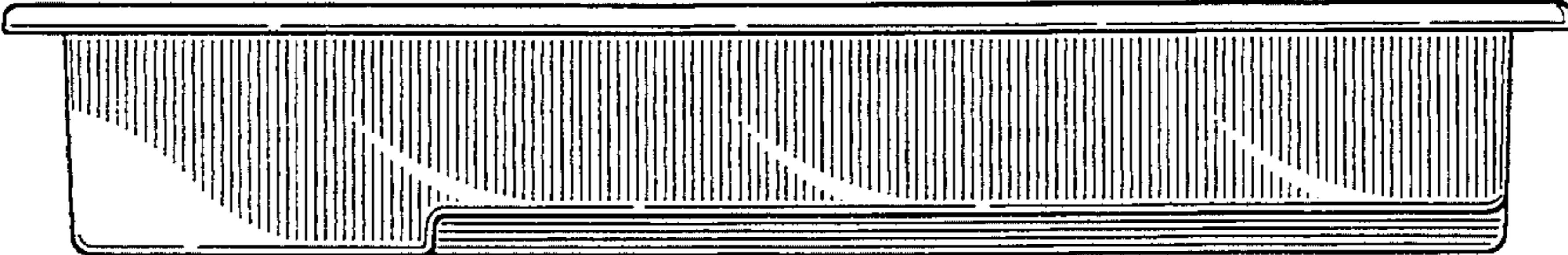

FIG-4

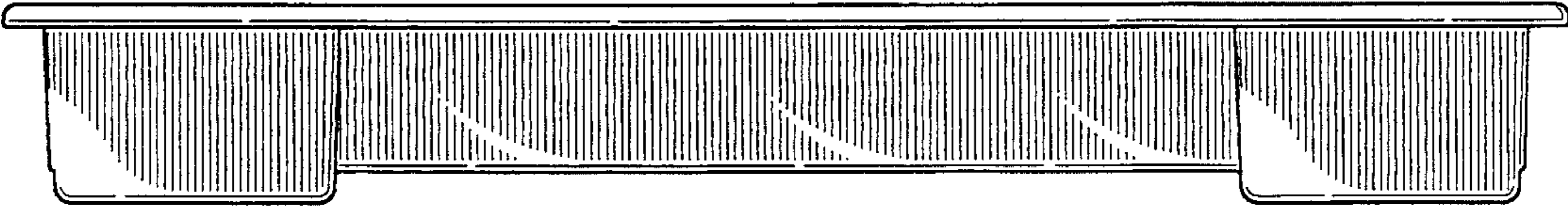

FIG-5

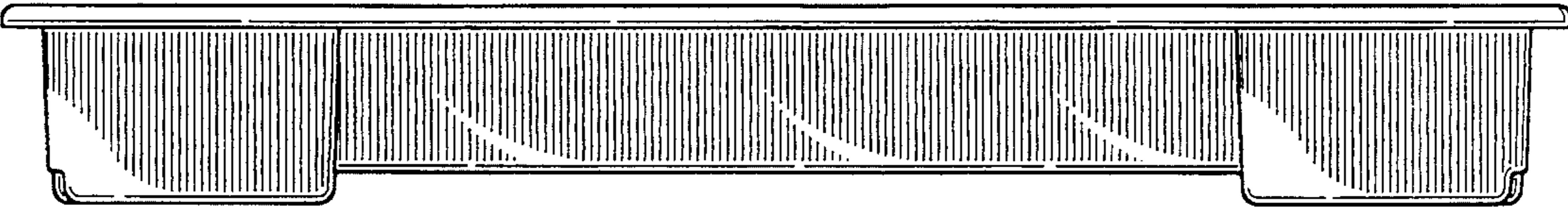

FIG-6

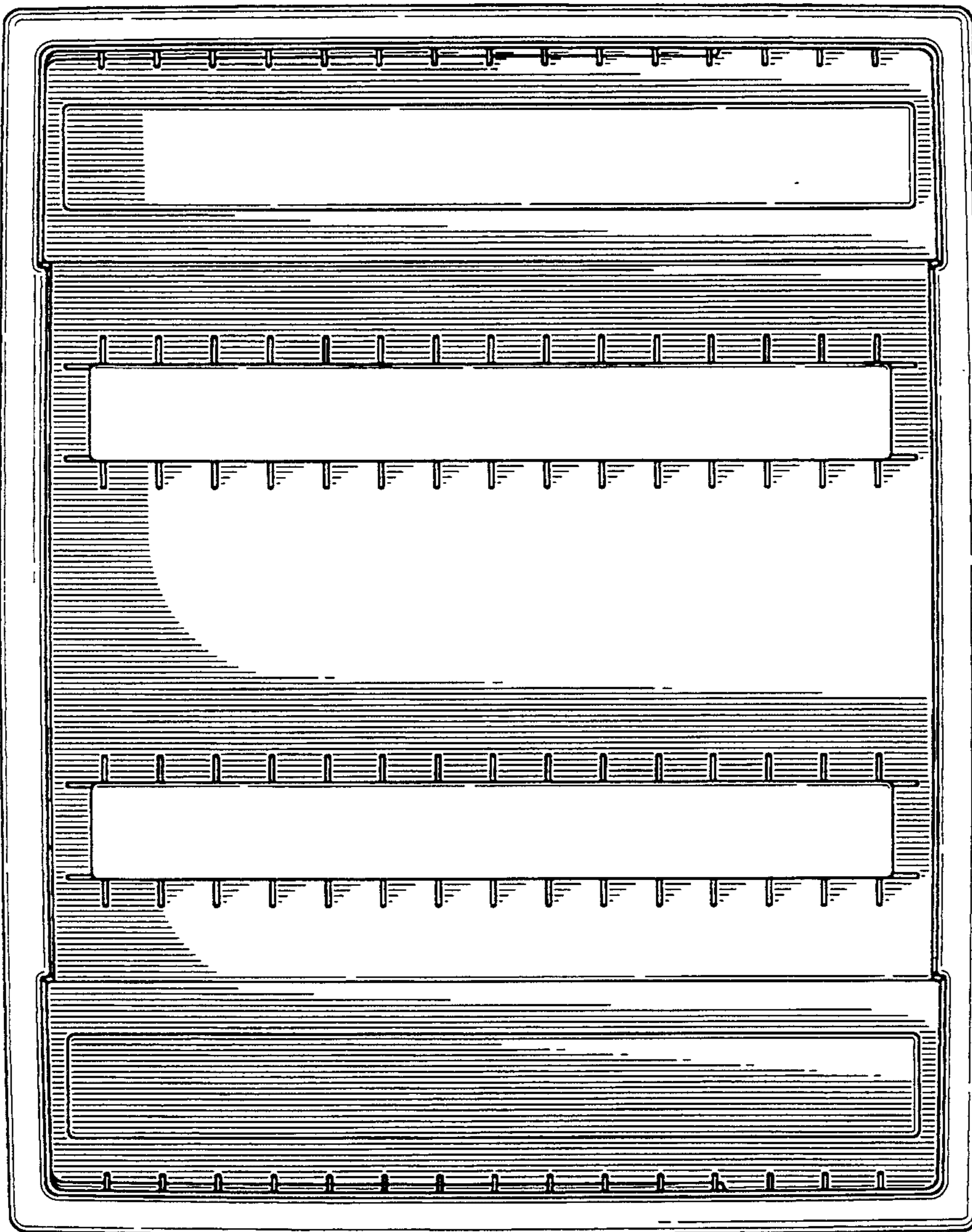

FIG-7

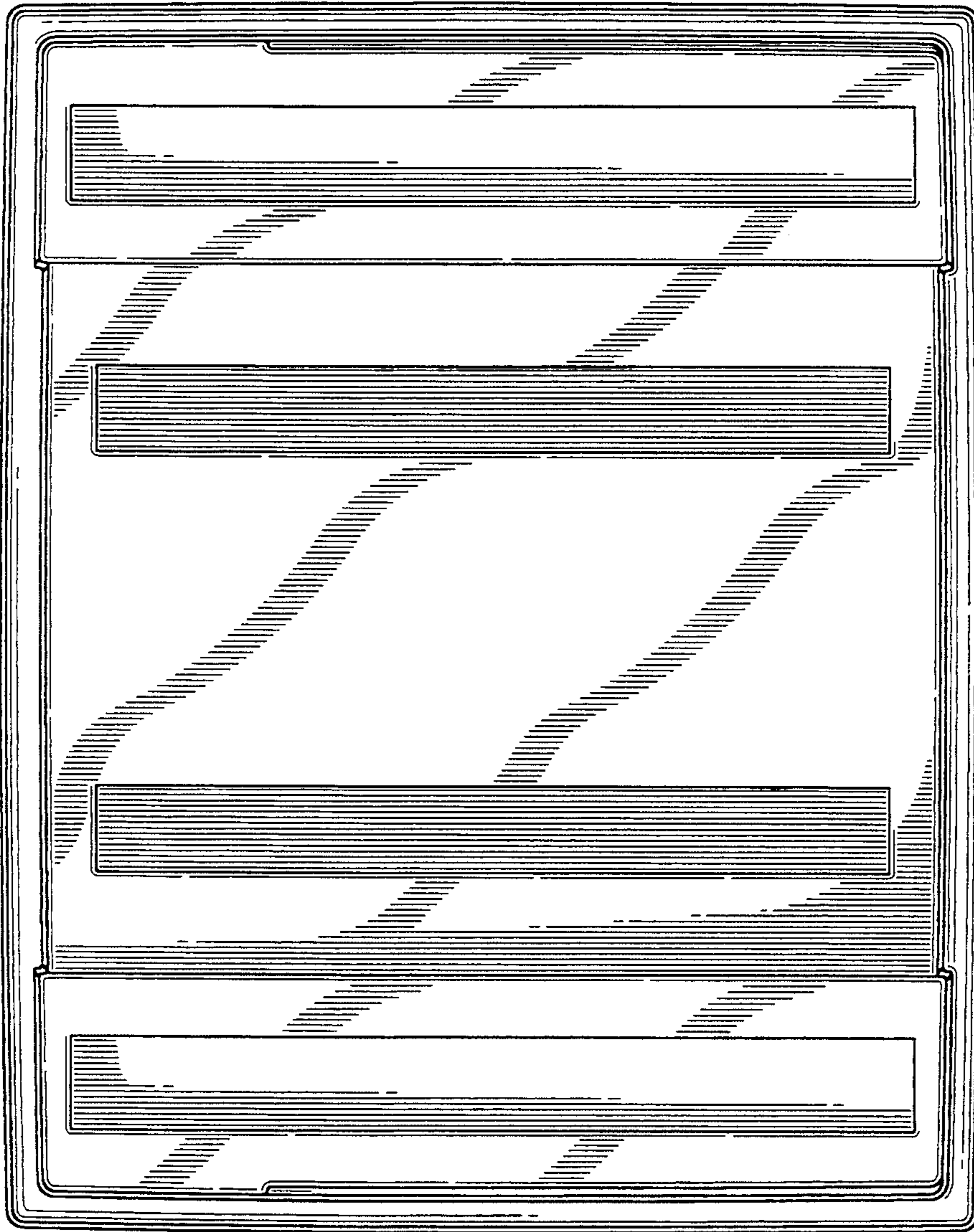

FIG-8

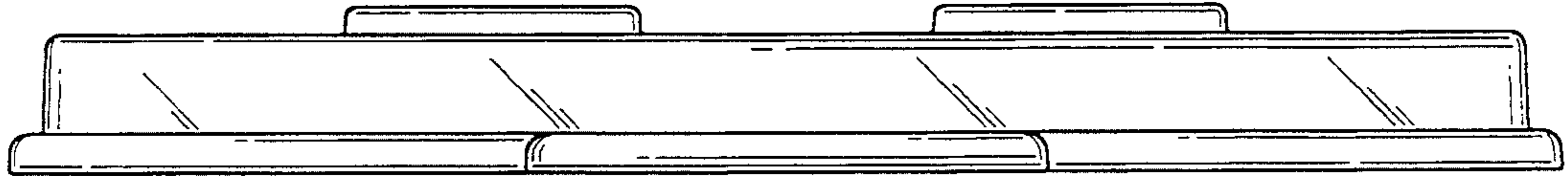

FIG-9

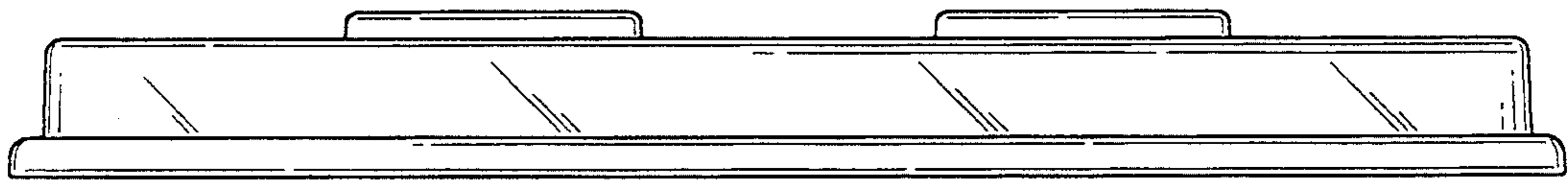

FIG-10

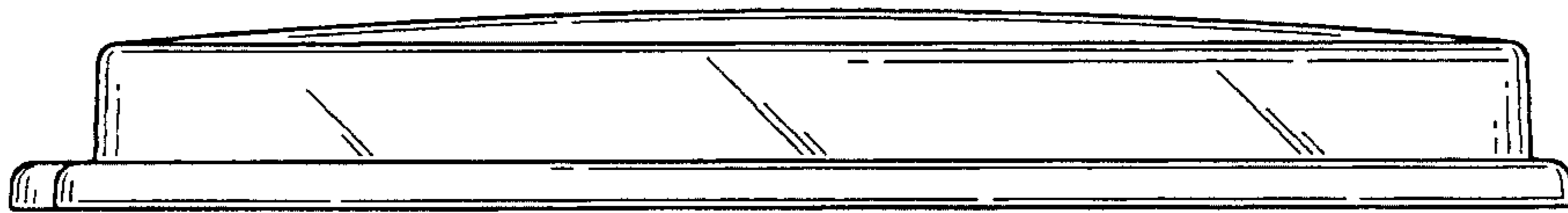

FIG-11

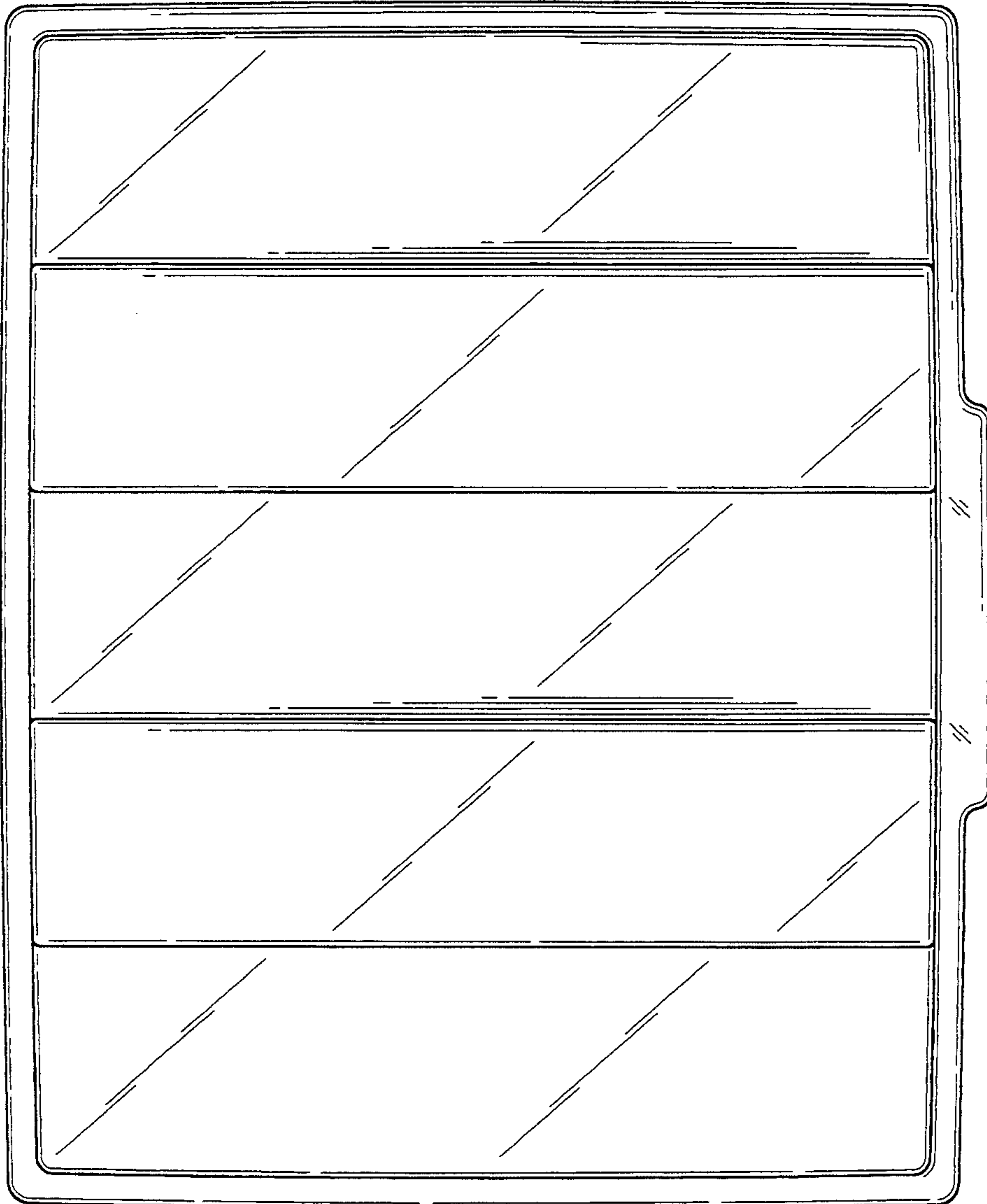

FIG-12