



US00D353498S

# United States Patent [19]

[11] Patent Number: **Des. 353,498**

Cox

[45] Date of Patent: **\*\* Dec. 20, 1994**

[54] **CHAIR**

[75] Inventor: **Brian D. Cox, Tempe, Ariz.**

[73] Assignee: **Bernhardt Furniture, Inc., Lenoir, N.C.**

[\*\*] Term: **14 Years**

[21] Appl. No.: **8,922**

[22] Filed: **Jun. 1, 1993**

[52] U.S. Cl. .... **D6/380; D6/379**

[58] Field of Search ..... **D6/334, 374, 379, 380, D6/500, 501, 502; 299/411.42**

[56] **References Cited**

**U.S. PATENT DOCUMENTS**

D. 255,625 7/1980 Lübke ..... D6/379

D. 312,005 11/1990 Snodgrass ..... D6/379  
D. 331,669 12/1992 Citterio ..... D6/380 X  
D. 332,531 1/1993 Guion ..... D6/380 X  
D. 334,298 3/1993 Panteloucos ..... D6/379

*Primary Examiner*—Wallace R. Burke  
*Assistant Examiner*—Monica A. Hannon

[57] **CLAIM**

The ornamental design for a chair, as shown.

**DESCRIPTION**

FIG. 1 is a perspective view of a chair showing my new design;  
FIG. 2 is a side elevational view thereof;  
FIG. 3 is a rear elevational view thereof;  
FIG. 4 is a front elevational view thereof;  
FIG. 5 is a top plan view thereof; and,  
FIG. 6 is a bottom view thereof.

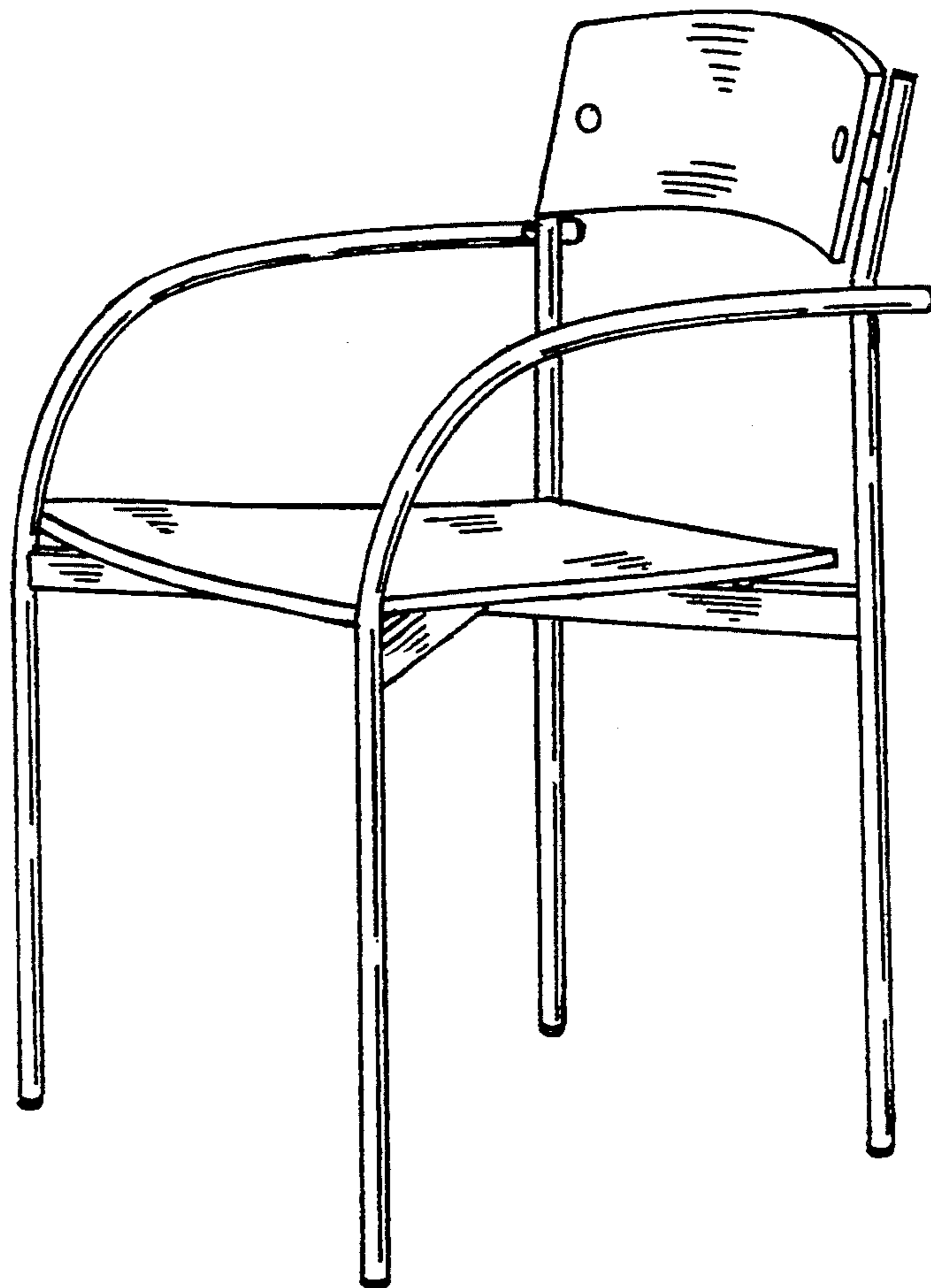

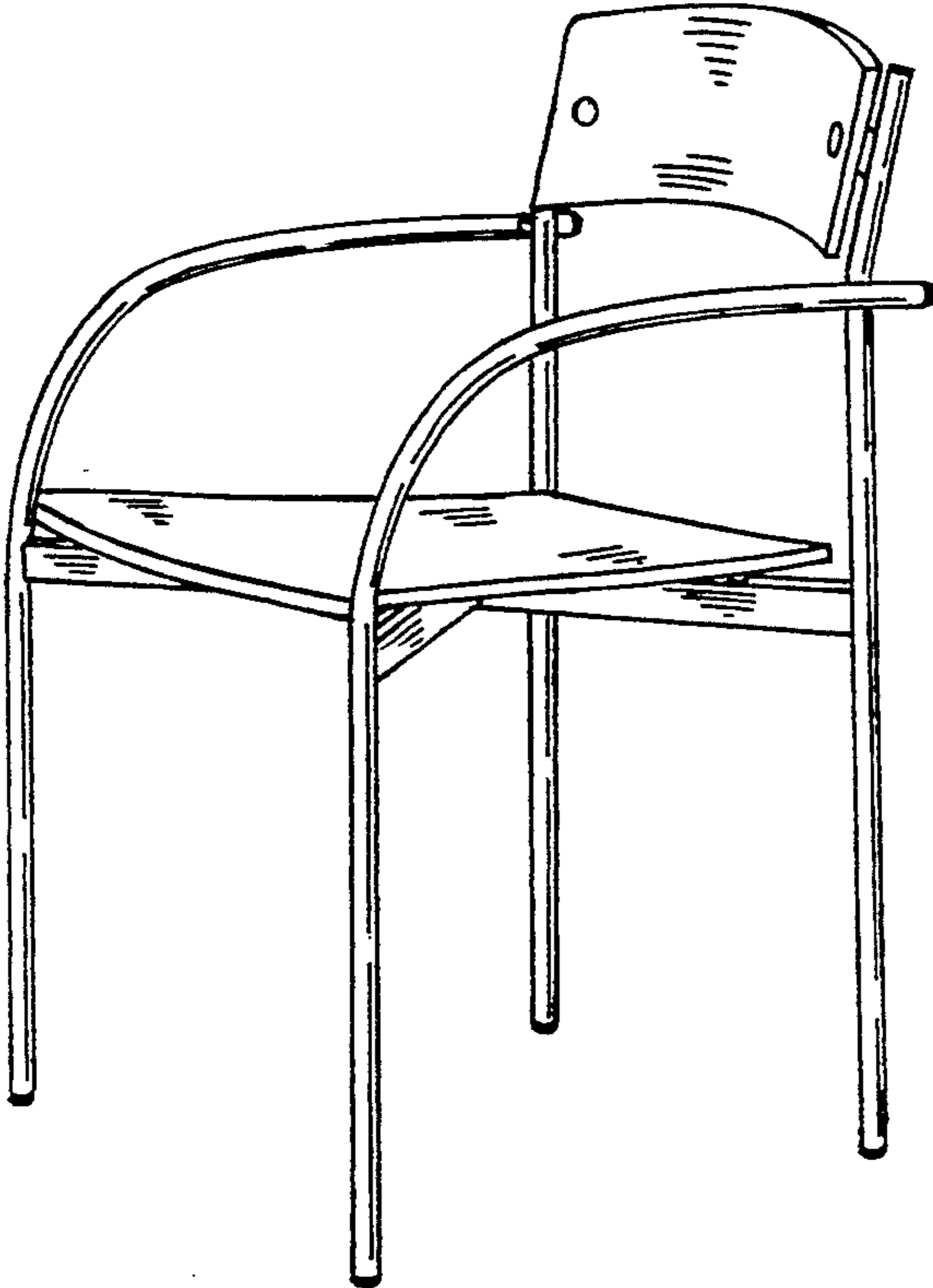

FIG. 1

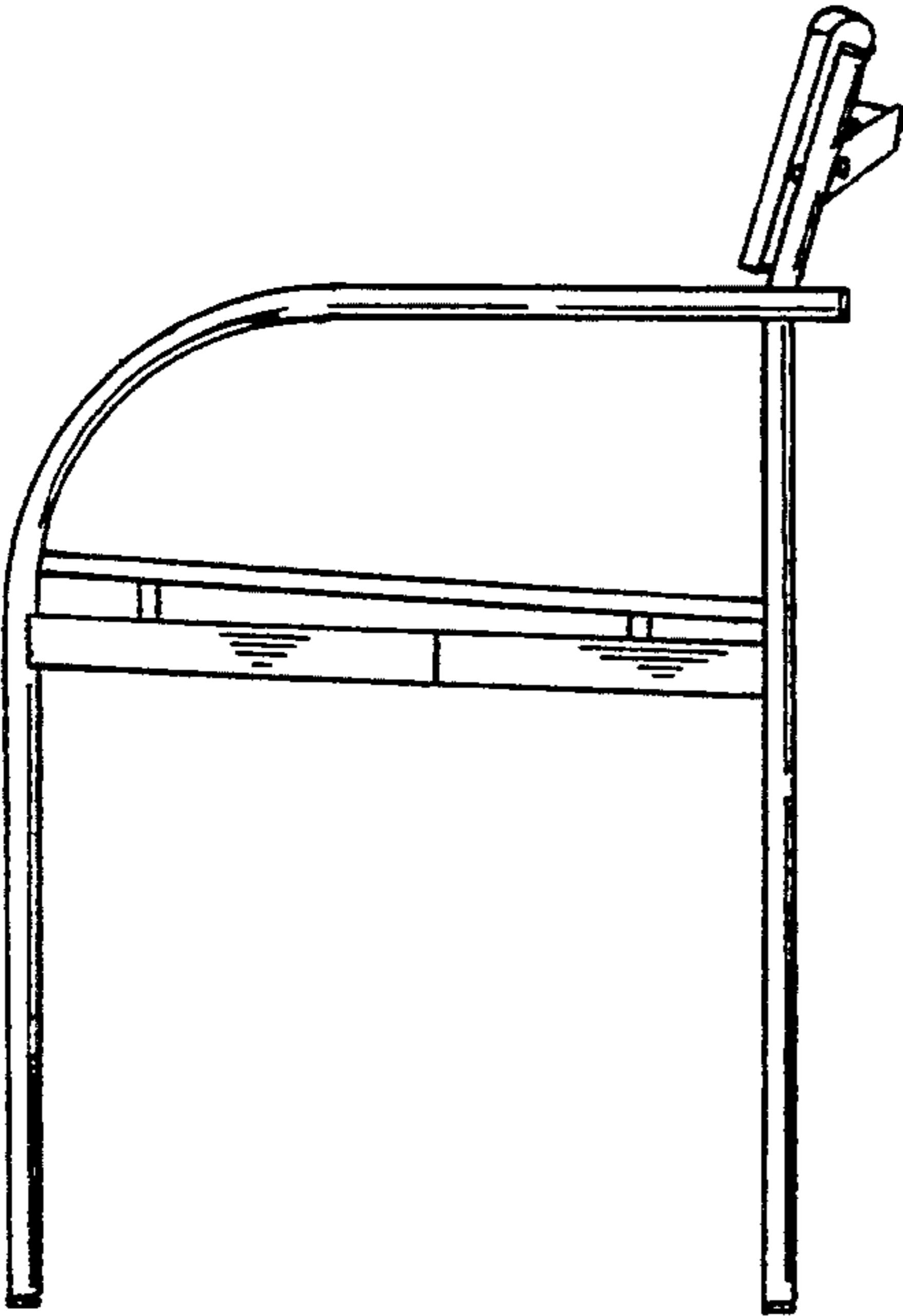

FIG. 2

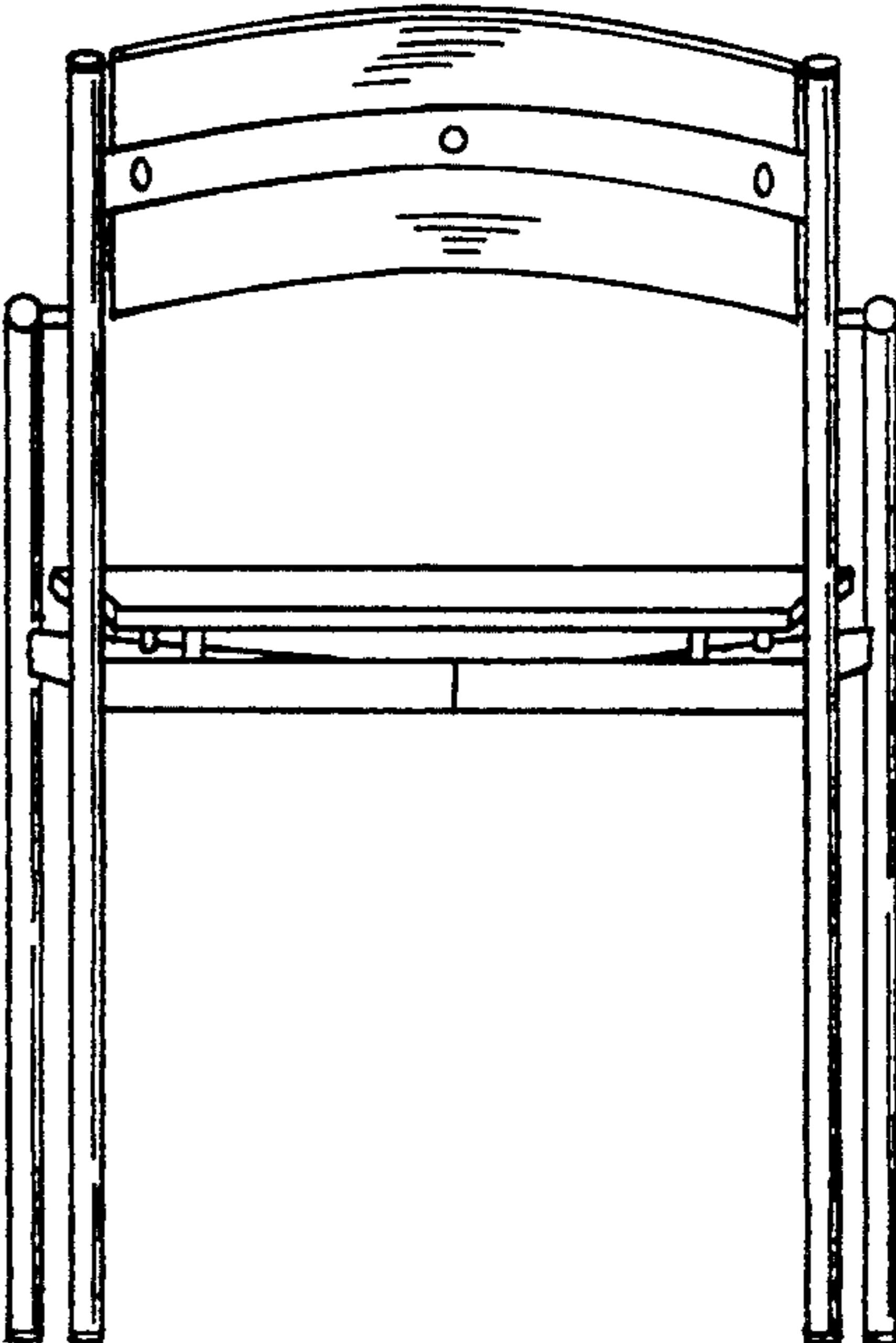

FIG. 3

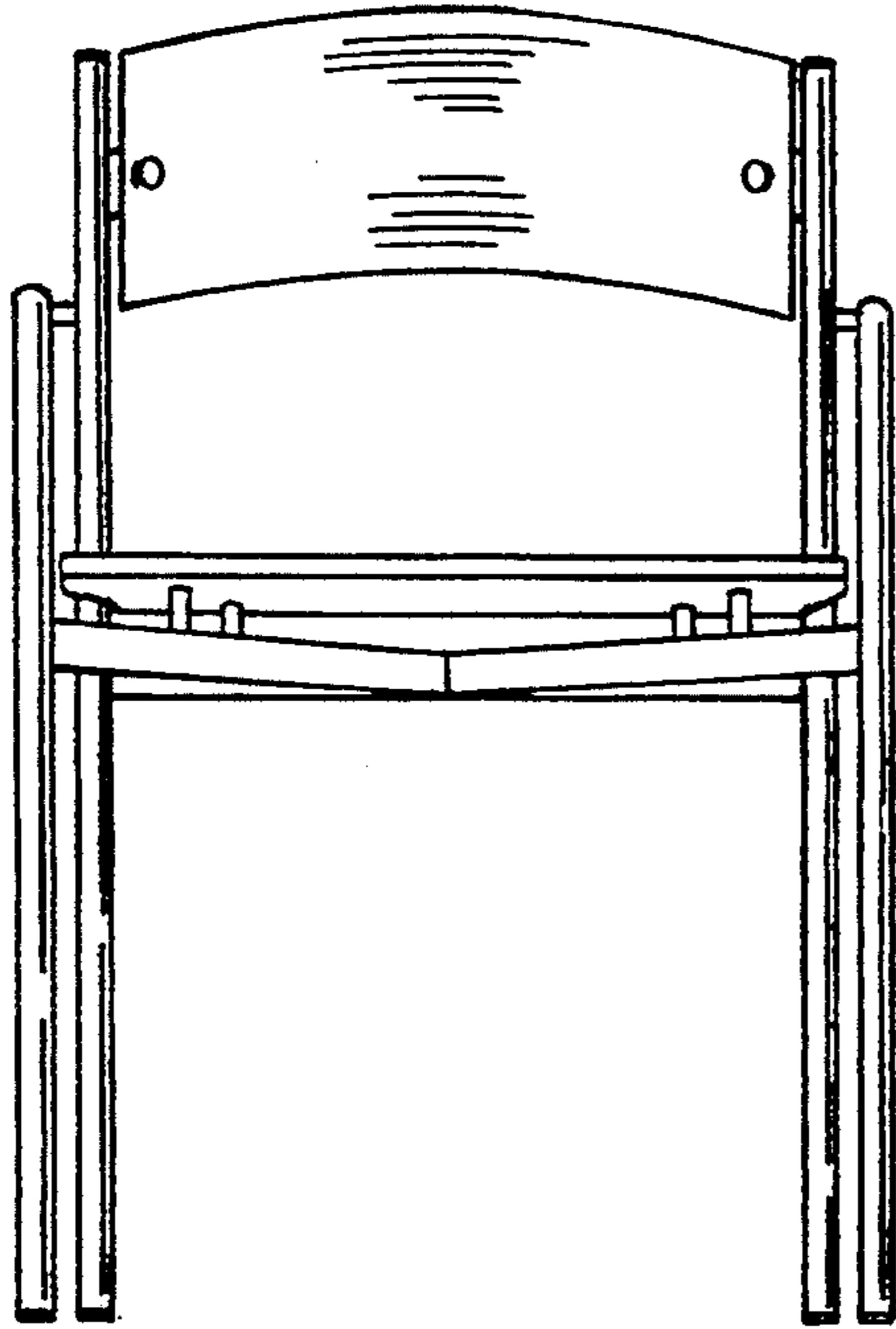

FIG. 4

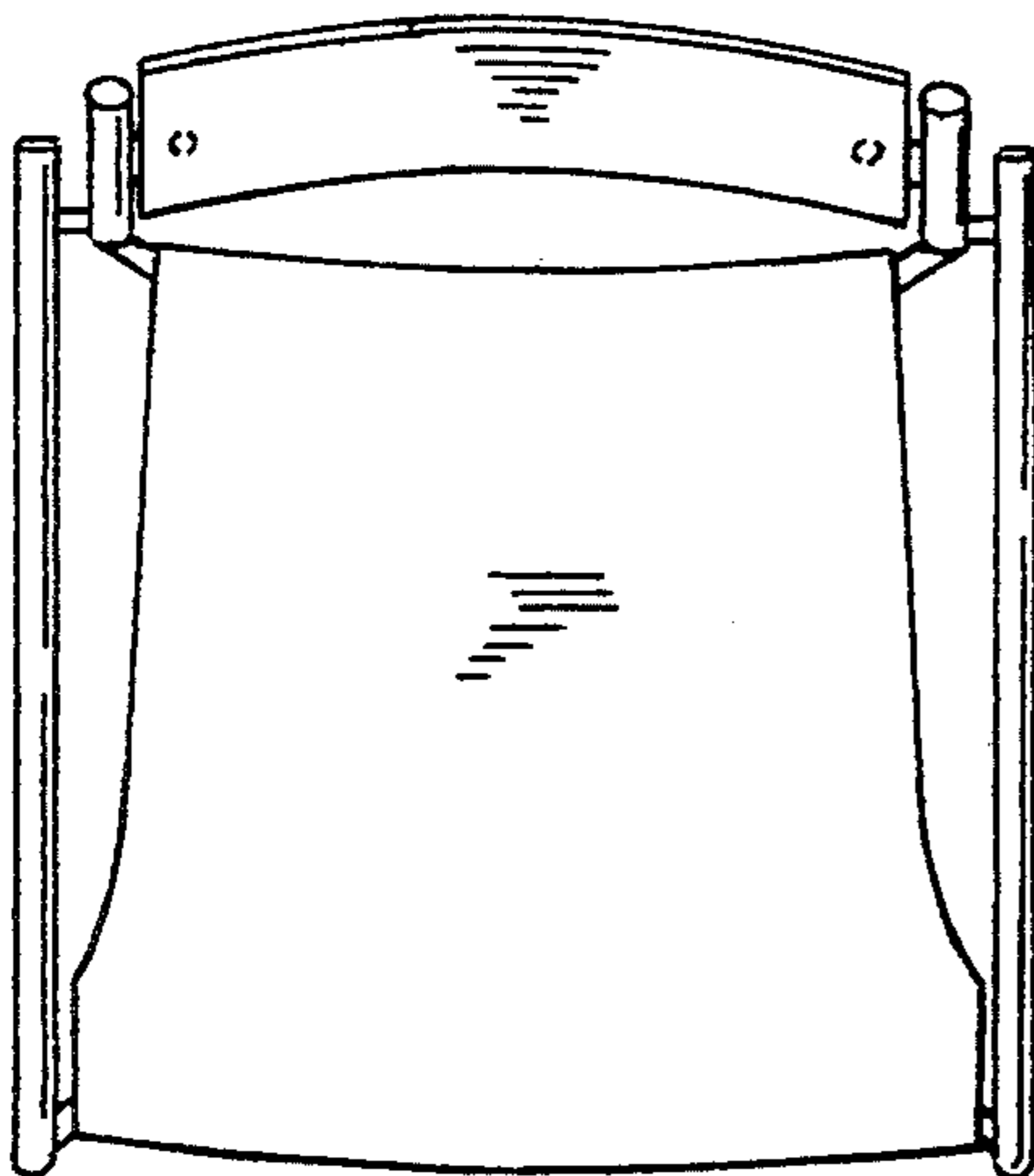

FIG. 5

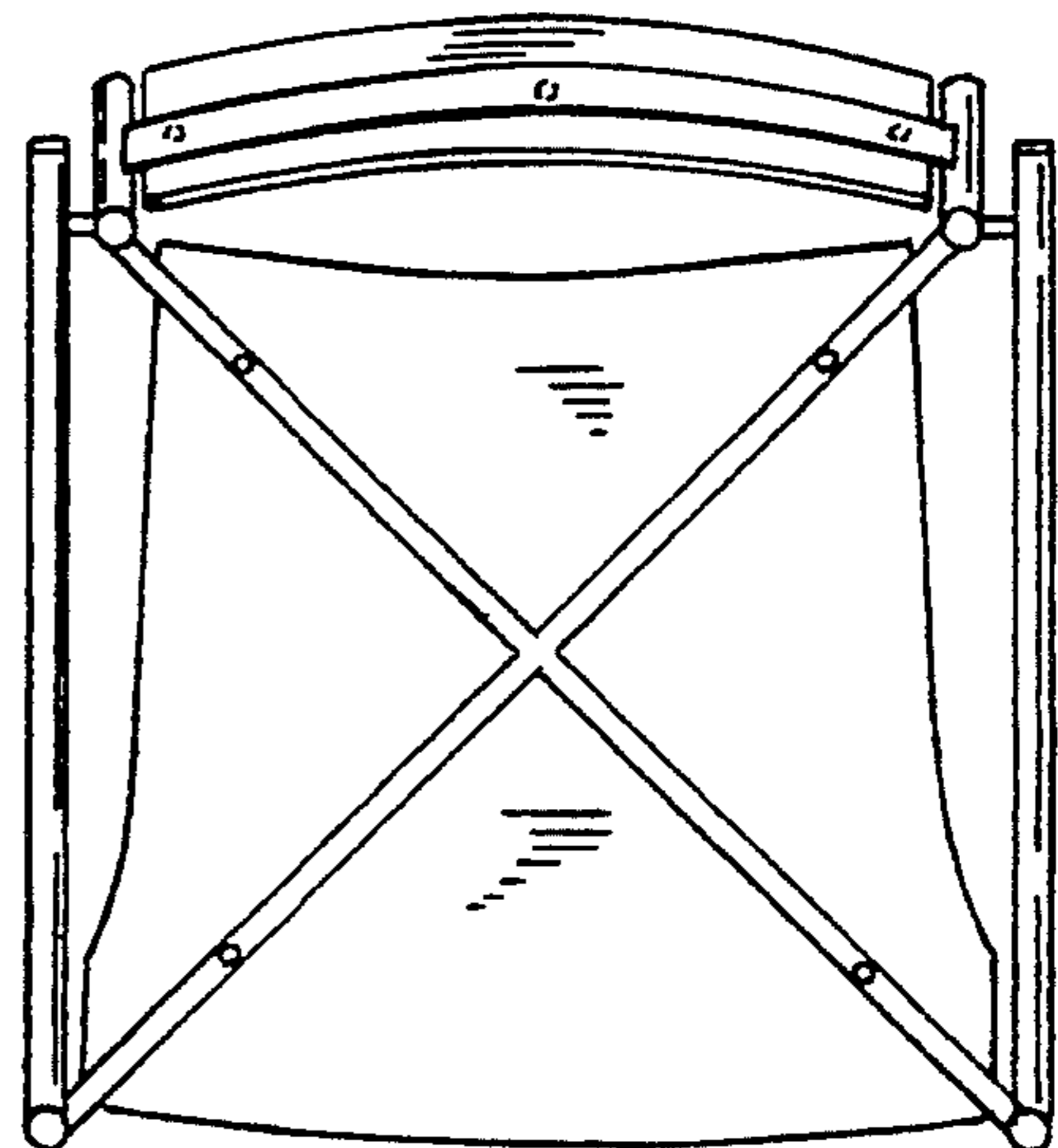

FIG. 6