



US00D353373S

# United States Patent [19]

[11] Patent Number: **Des. 353,373**

Delhaes

[45] Date of Patent: **\*\* Dec. 13, 1994**

[54] **COMBINED TELEPHONE HANDSET WITH CHARGING UNIT**

[75] Inventor: **Josef M. R. Delhaes,**  
Muehlheim/Lämmerspiel, Germany

[73] Assignee: **U.S. Philips Corporation,** New York, N.Y.

[\*\*] Term: **14 Years**

[21] Appl. No.: **11,950**

[22] Filed: **Aug. 18, 1993**

[30] **Foreign Application Priority Data**

Mar. 22, 1993 [WO] WIPO ..... DM/025594

[52] U.S. Cl. .... **D14/149; D13/108;**  
D14/148

[58] **Field of Search** ..... 379/58-61,  
379/419, 420, 428, 440, 433-436; 439/357, 298,  
660, 929; D14/140, 142, 149-151, 147, 148, 137,  
138, 240, 241; D13/108

[56] **References Cited**

**U.S. PATENT DOCUMENTS**

- D. 238,374 1/1976 Davis et al. .... D14/142
- D. 257,977 1/1981 Blomberg ..... D14/148
- D. 291,801 9/1989 Suzuki et al. .... D14/138
- D. 303,383 9/1989 Reichenstein ..... D14/149 X
- D. 305,652 1/1990 Tejima ..... D14/138

- D. 313,800 1/1941 Appleby ..... D14/151
- D. 323,164 1/1992 Myoga ..... D14/143 X
- D. 343,541 2/1994 Hon et al. .... D13/108 X
- 3,183,891 5/1965 MacDonald ..... D13/108 X
- 4,543,451 9/1985 Schoen ..... 379/434 X

**FOREIGN PATENT DOCUMENTS**

1215958 12/1970 United Kingdom ..... 379/434

*Primary Examiner*—Alan P. Douglas  
*Assistant Examiner*—Jeffrey Asch  
*Attorney, Agent, or Firm*—Jack E. Haken

[57] **CLAIM**

The ornamental design for a combined telephone handset with charging unit, as shown and described.

**DESCRIPTION**

FIG. 1 is a front, right side, perspective view showing our new design in which the telephone handset is separated from the charging unit;  
FIG. 2 is a front elevational view thereof;  
FIG. 3 is a rear elevational view thereof;  
FIG. 4 is a right side elevational view thereof;  
FIG. 5 is a left side elevational view thereof;  
FIG. 6 is a top plan view thereof;  
FIG. 7 is a bottom plan view thereof; and,  
FIG. 8 is a front, right side, perspective view showing our new design in which the telephone handset is integrated with the charging unit.

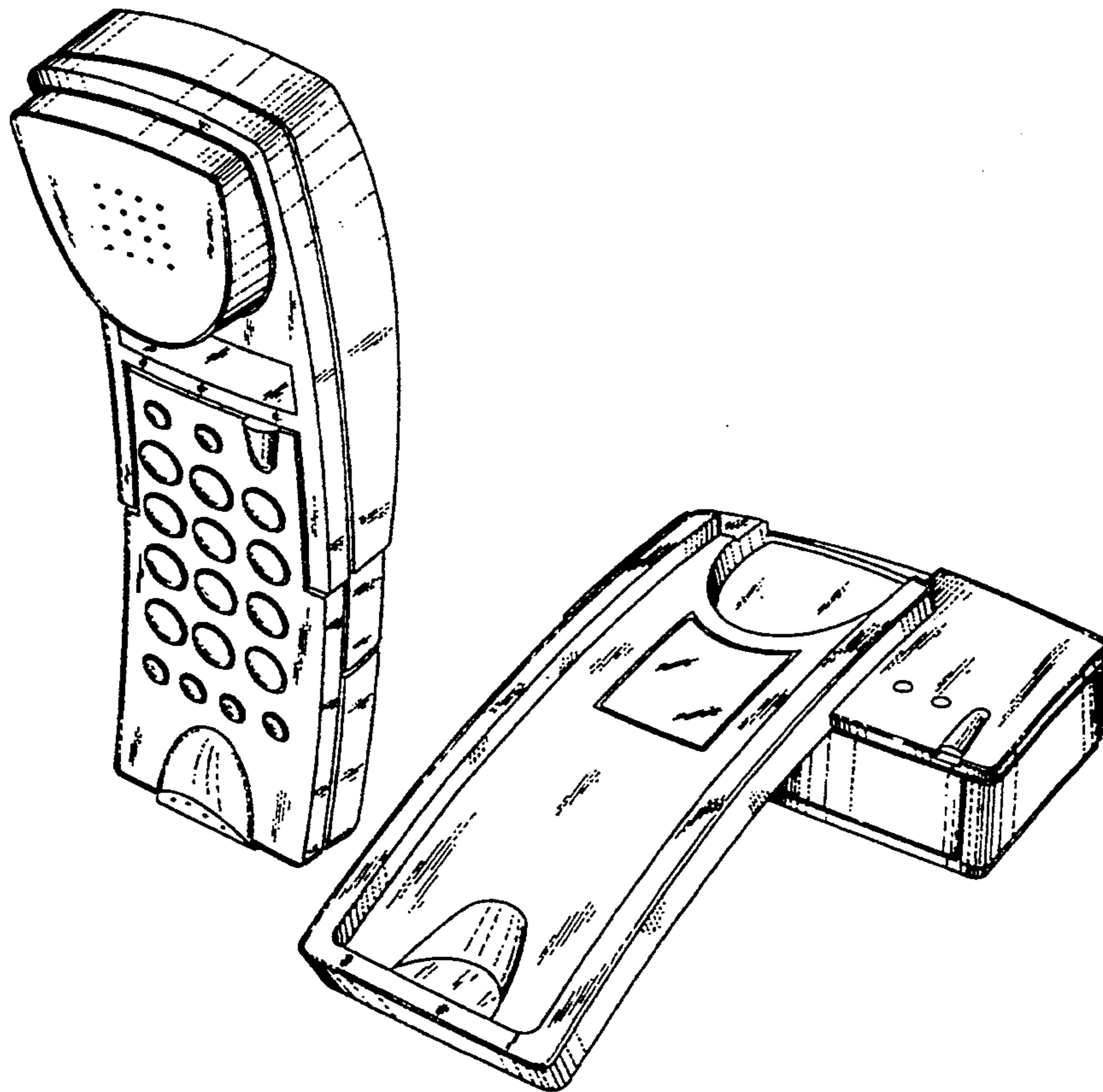

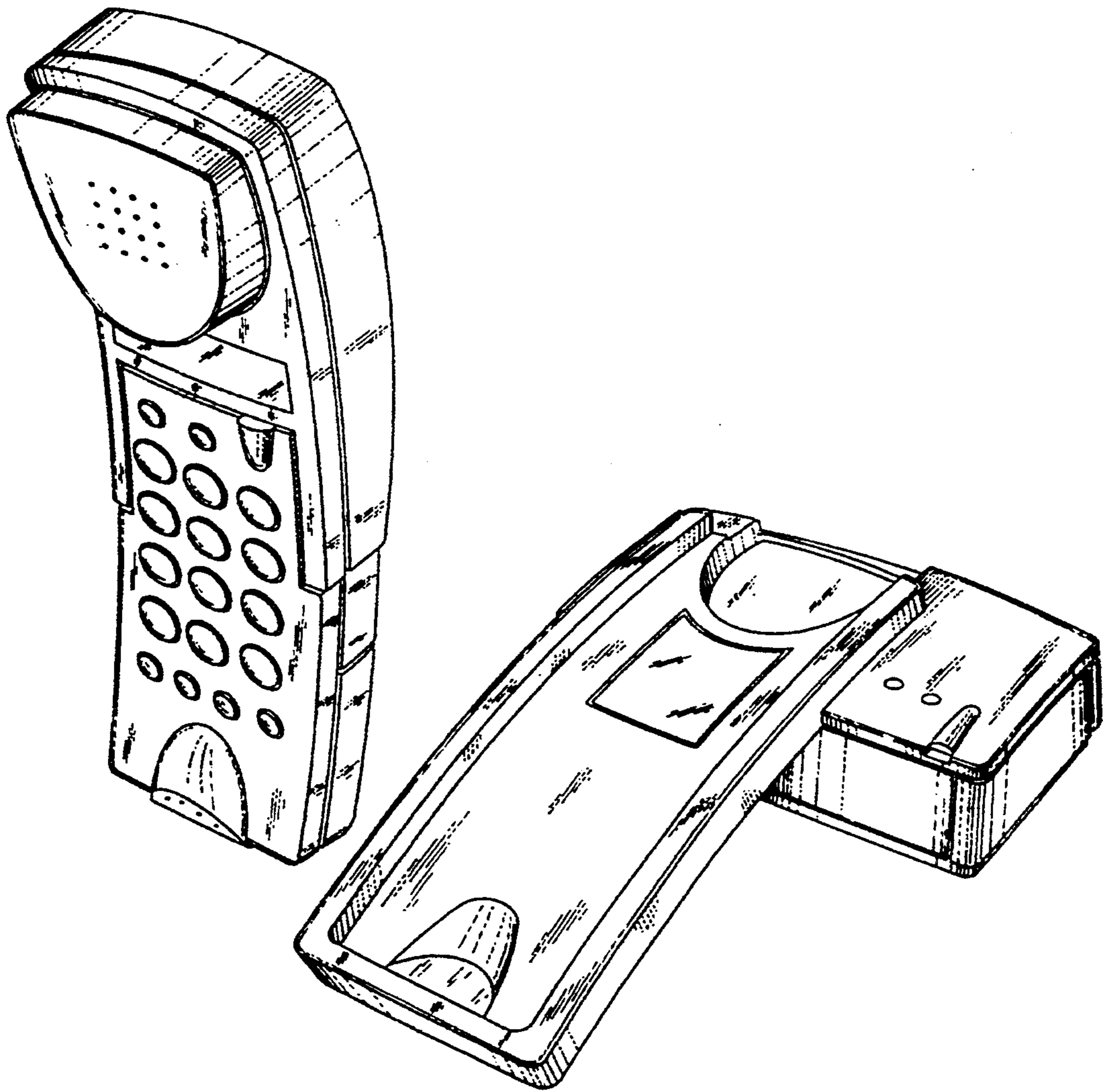

FIG. 1

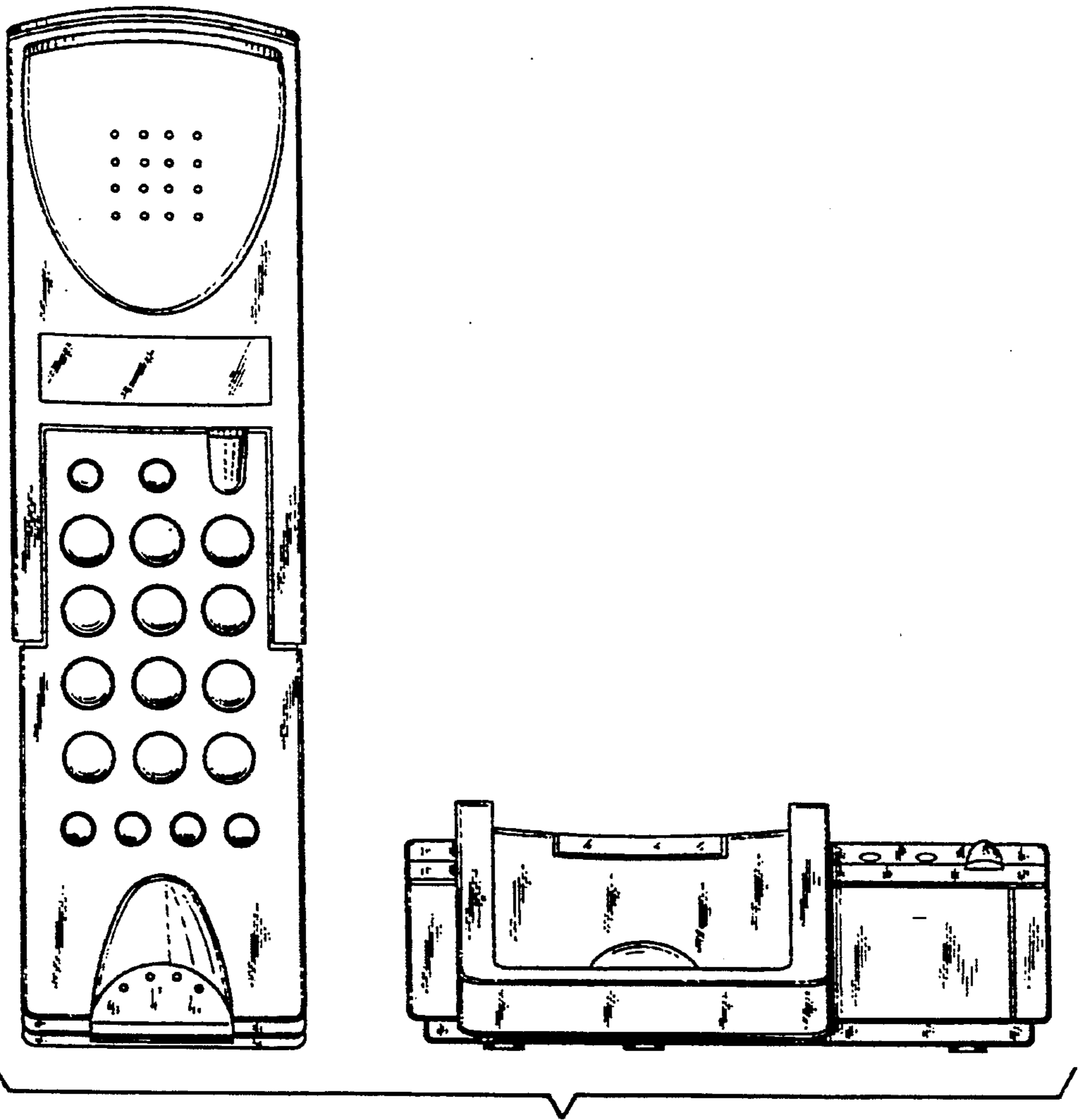

FIG.2

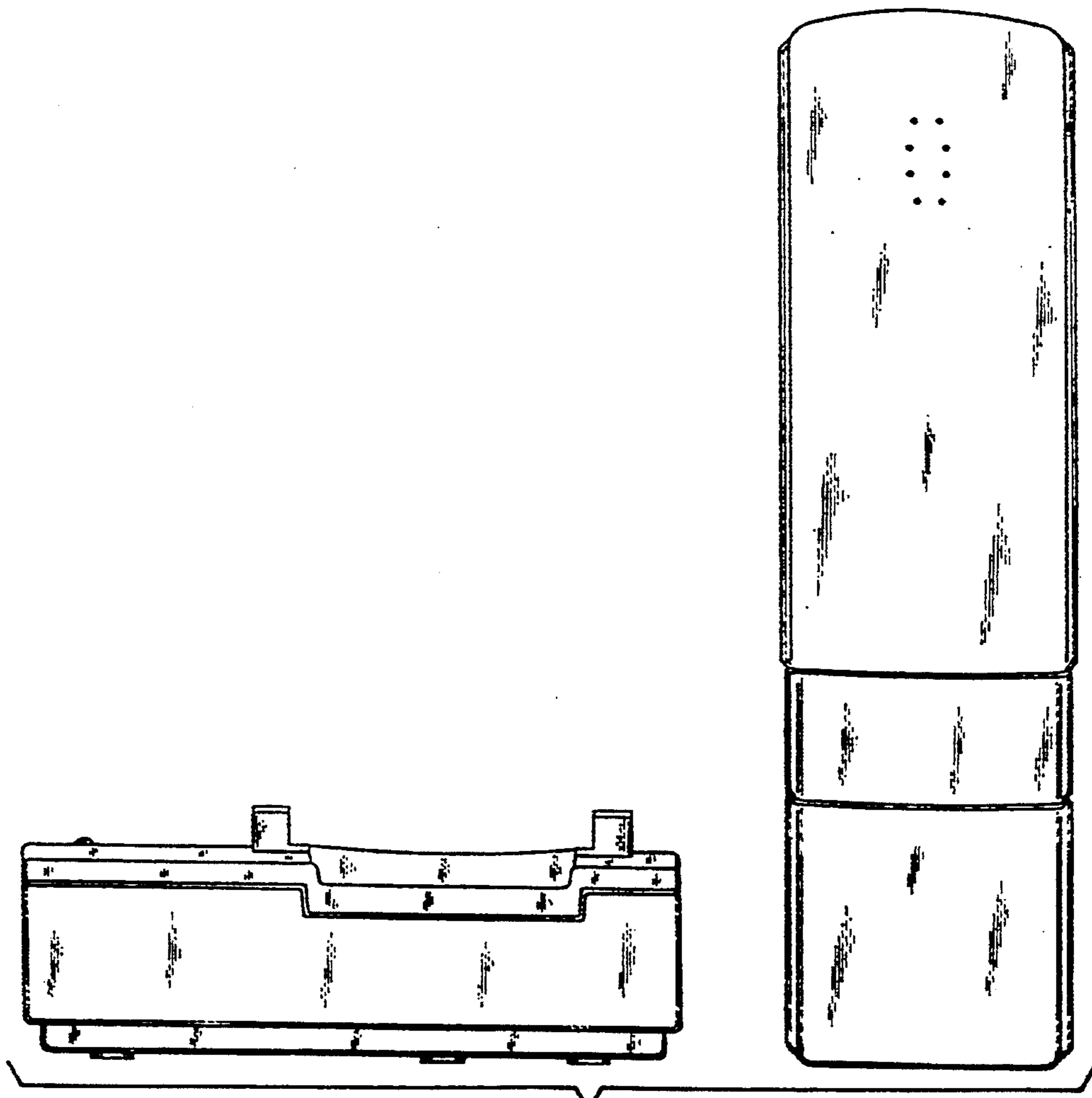

FIG. 3

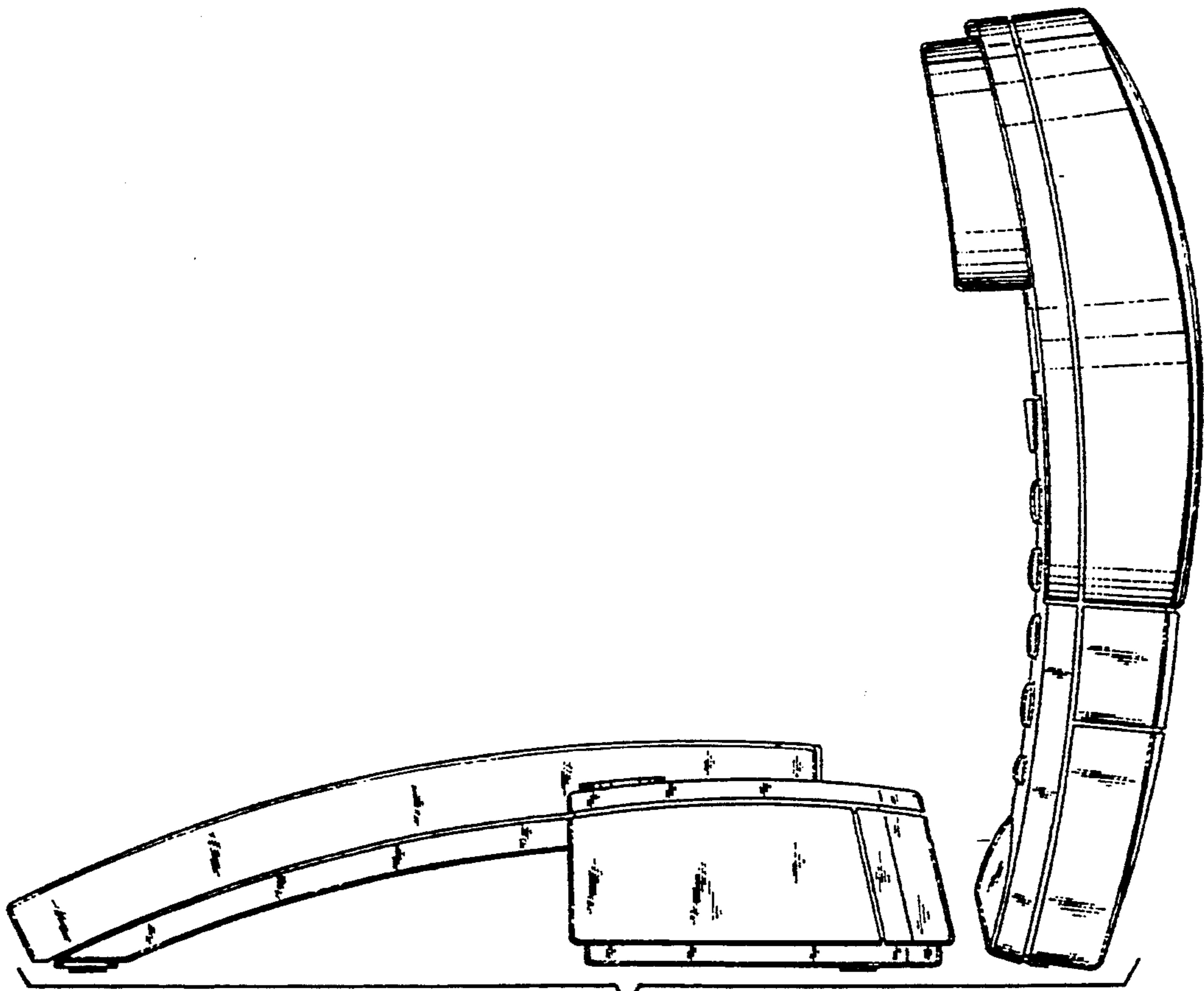

FIG.4

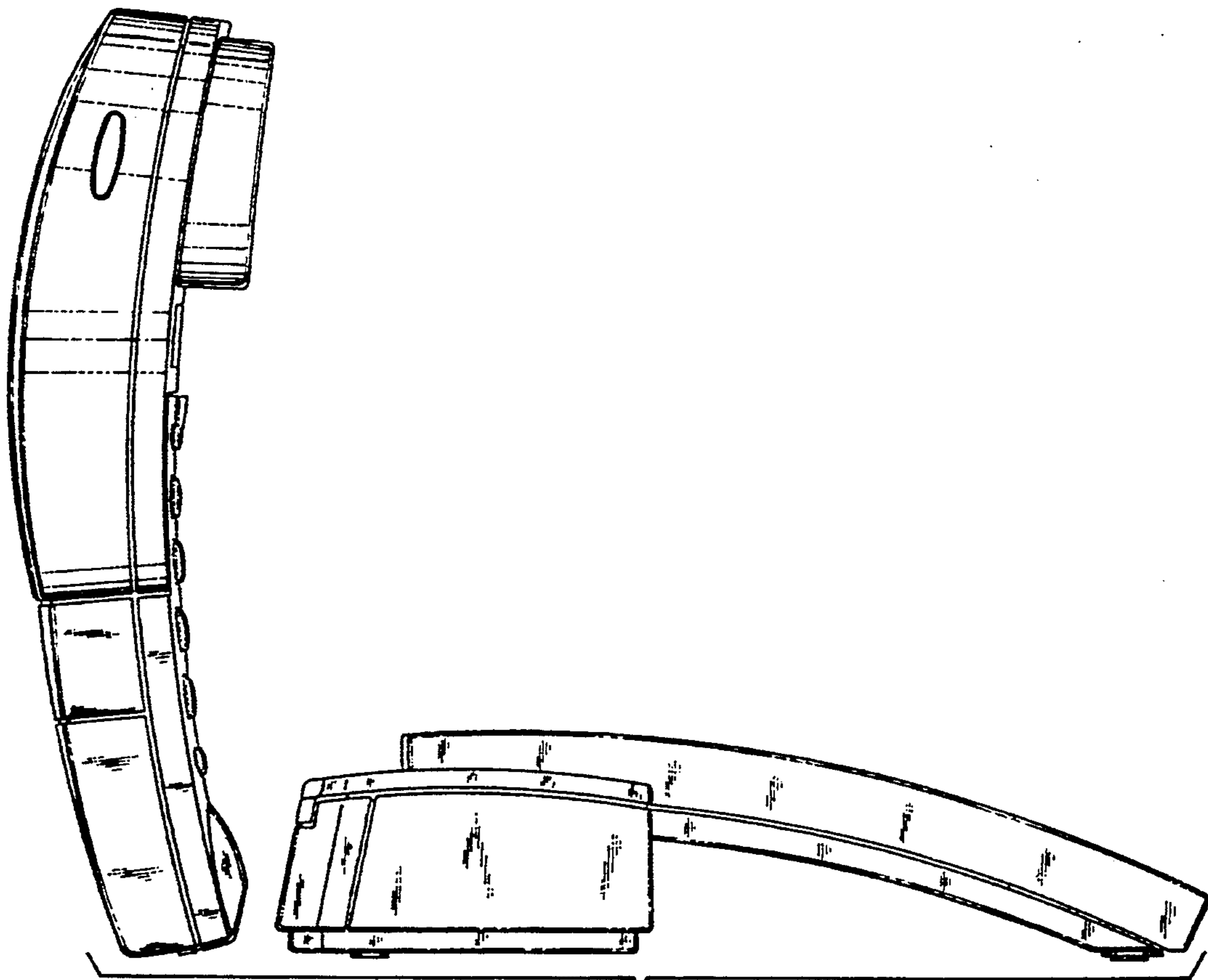

FIG.5

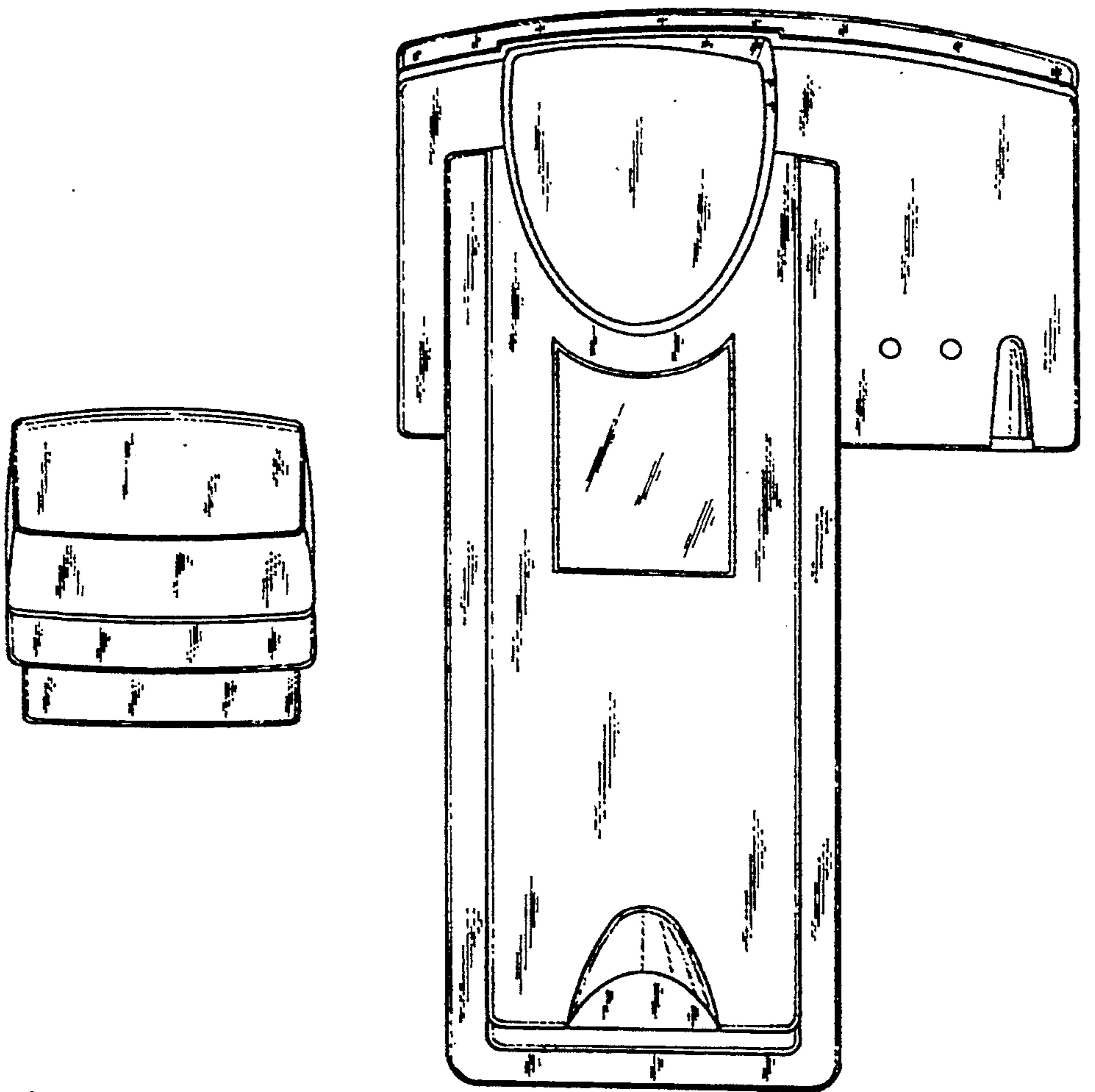

FIG.6

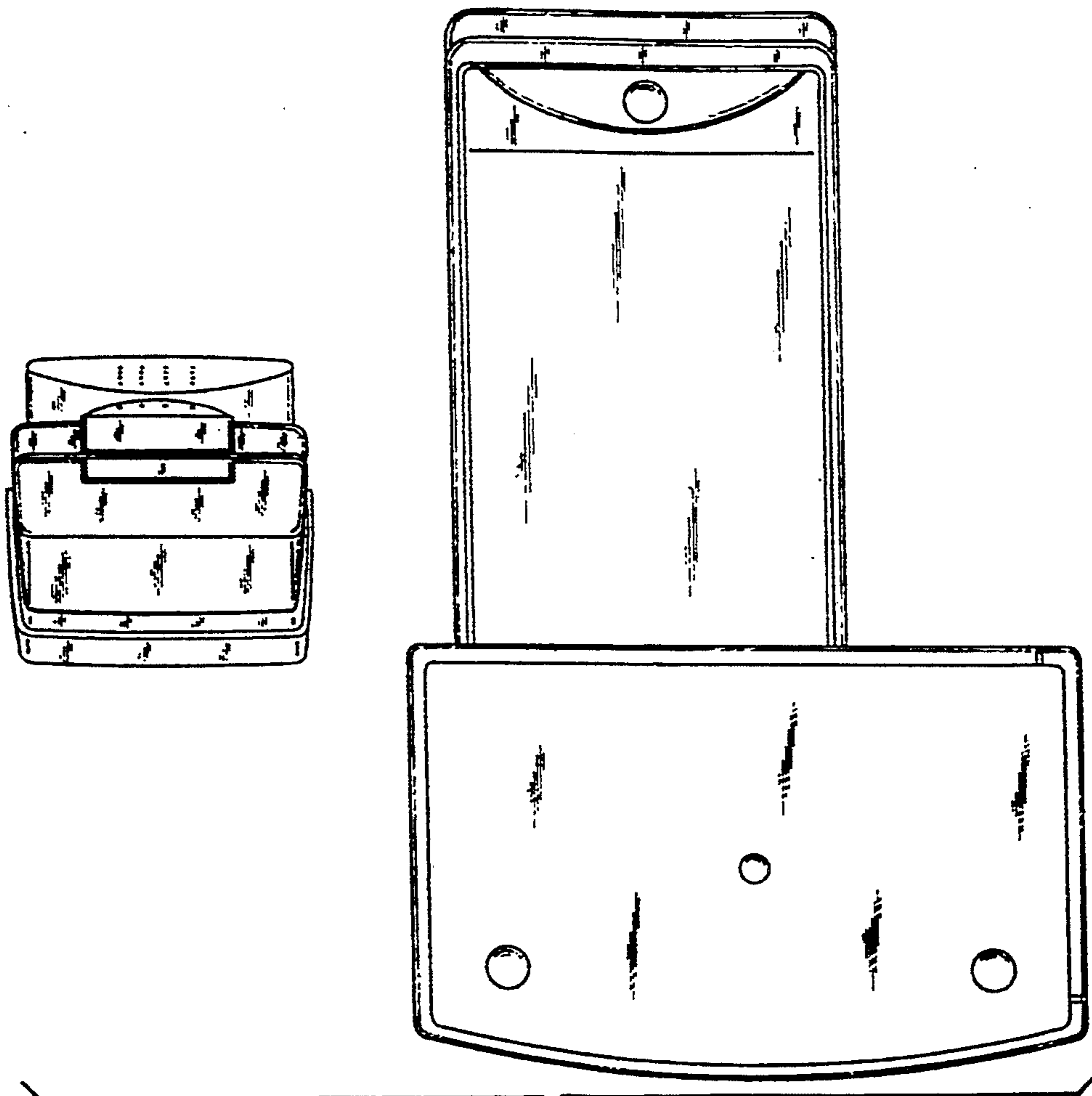

FIG.7



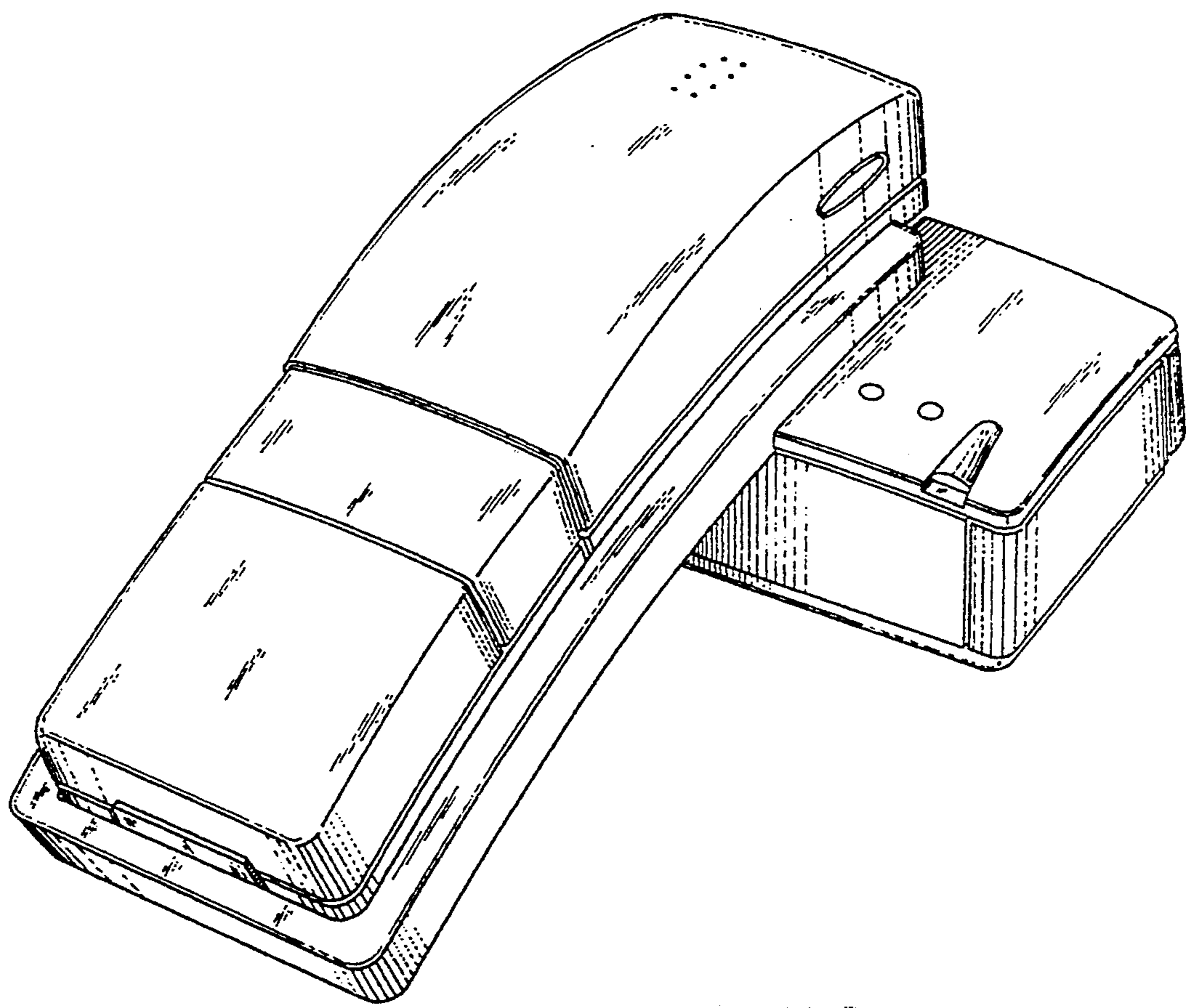

FIG.8