



US00D353261S

# United States Patent [19]

[11] Patent Number: **Des. 353,261**

Fort et al.

[45] Date of Patent: **\*\* Dec. 13, 1994**

[54] **KEY CHAIN**

[76] Inventors: **Walter J. Fort**, 205 Lenore Dr.;  
**William G. Minear**, 1103 Woodward Ave.;  
**Paul F. Hothouse**, 821 Russellwood Ave., all of McKees Rocks, Pa. 15136; **Mirko C. Novosel**, 21 Scenic Dr., Coraopolis, Pa. 15108

[\*\*] Term: **14 Years**

[21] Appl. No.: **11,547**

[22] Filed: **Aug. 9, 1993**

[52] U.S. Cl. .... **D3/211**

[58] Field of Search ..... **D3/207-212;**  
**24/3 K; 70/456 R, 456 B, 457-460**

[56] **References Cited**

**U.S. PATENT DOCUMENTS**

D. 162,443	3/1951	Parenti	.....	D3/65
D. 255,510	6/1980	Quenot	.....	D3/62
2,694,844	11/1954	Grumbach	.....	D3/61
4,936,699	6/1990	Yoshida	.....	D11/3

*Primary Examiner*—Ralf T. Seifert  
*Attorney, Agent, or Firm*—Arnold B. Silverman

[57] **CLAIM**

The ornamental design for a decorative key chain, as shown and described.

**DESCRIPTION**

FIG. 1 is a perspective view of the key chain of the present invention having a football ornament;  
 FIG. 2 is a front elevational view of the key chain of FIG. 1;  
 FIG. 3 is a rear elevational view of the key chain of FIG. 2;  
 FIG. 4 is a right-side elevational view of the key chain in FIG. 1;  
 FIG. 5 is a left-side elevational view of the key chain in FIG. 1;  
 FIG. 6 is a top plan view of the key chain of FIG. 1;  
 FIG. 7 is a bottom plan view of the key chain of FIG. 1;  
 FIG. 8 is a front elevational view of a key chain showing a second embodiment of the present invention hav-

ing a basketball ornament. The rear elevational view is the same as FIG. 3;  
 FIG. 9 is a right-side elevational view of the key chain of FIG. 8;  
 FIG. 10 is a left-side elevational view of the key chain of FIG. 8;  
 FIG. 11 is a top plan view of the key chain of FIG. 8;  
 FIG. 12 is a bottom plan view of the key chain in FIG. 8;  
 FIG. 13 is a front elevational view of the key chain showing a third embodiment of the present invention having a baseball ornament. The rear elevational view is the same as FIG. 3;  
 FIG. 14 is a right-side elevational view of the key chain of FIG. 13;  
 FIG. 15 is a left-side elevational view of the key chain of FIG. 13;  
 FIG. 16 is a top plan view of the key chain of FIG. 13;  
 FIG. 17 is a bottom plan view of the key chain of FIG. 13;  
 FIG. 18 is a front elevational view of the key chain showing a fourth embodiment with a soccer ornament. The rear elevational view is the same as FIG. 3;  
 FIG. 19 is a right-side elevational view of the key chain of FIG. 18;  
 FIG. 20 is a left-side elevational view of the key chain of FIG. 18;  
 FIG. 21 is a top plan view of the key chain of FIG. 18;  
 FIG. 22 is a bottom plan view of the key chain of FIG. 18;  
 FIG. 23 is a front elevational view of a key chain showing a fifth embodiment of the invention with a hockey ornament. The rear elevational view is the same as FIG. 3;  
 FIG. 24 is a right-side elevational view of the key chain of FIG. 23;  
 FIG. 25 is a left-side elevational view of the key chain of FIG. 23;  
 FIG. 26 is a top plan view of the key chain of FIG. 23;  
 FIG. 27 is a bottom plan view of the key chain of FIG. 23;  
 FIG. 28 is a front elevational view of a key chain showing a sixth embodiment of the invention with a megaphone ornament. The rear elevational view is the same as FIG. 3;  
 FIG. 29 is a right-side elevational view of the key chain of FIG. 28;

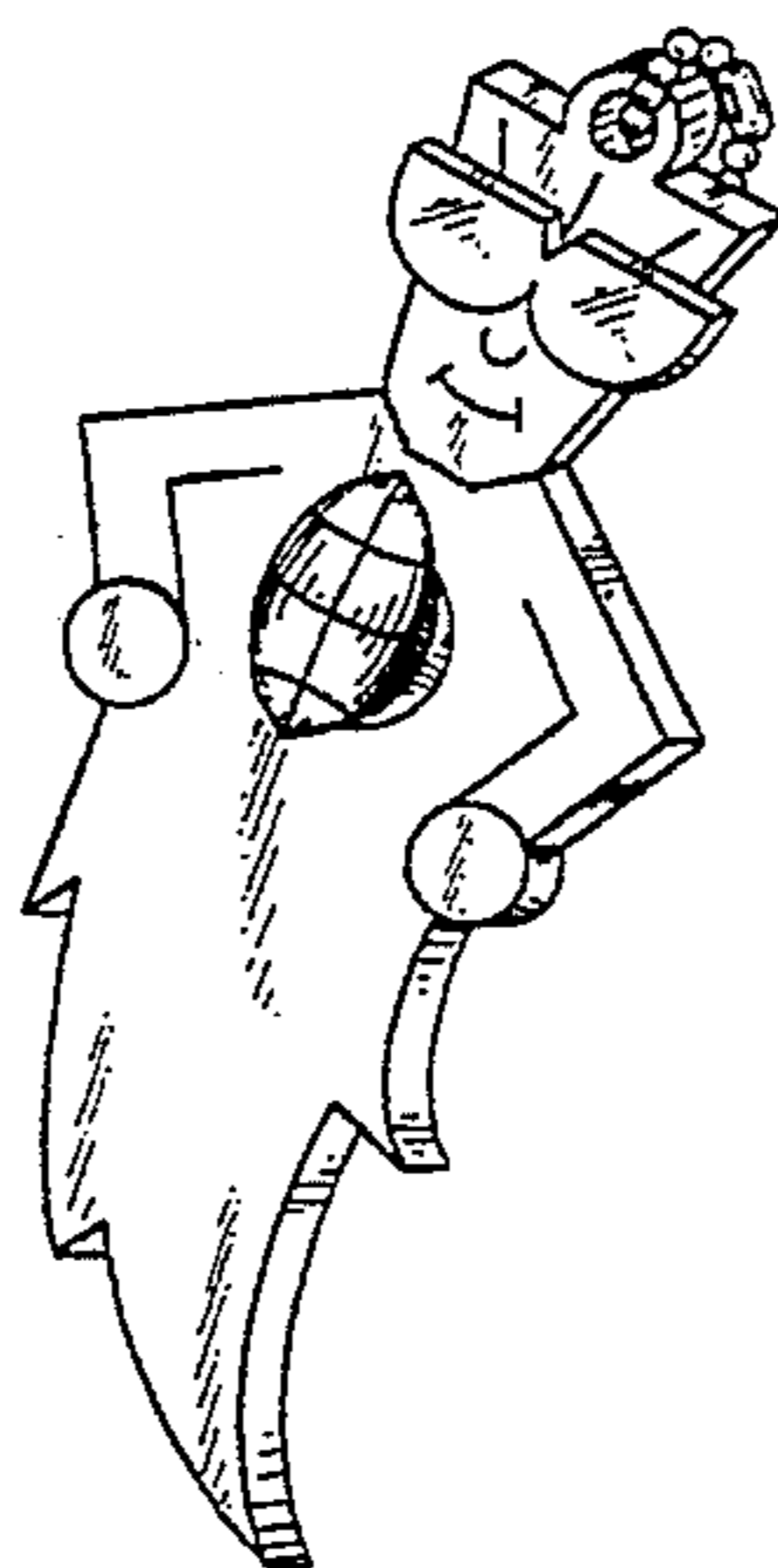

FIG. 30 is a left-side elevational view of the key chain of FIG. 28;

FIG. 31 is a top plan view of the key chain of FIG. 28;

FIG. 32 is a bottom plan view of the key chain of FIG. 28;

FIG. 33 is a front elevational view of a key chain showing a seventh embodiment of the present invention employing a heart ornament. The rear elevational view is the same as FIG. 3;

FIG. 34 is a right-side elevational view of the key chain of FIG. 33;

FIG. 35 is a left-side elevational view of the key chain of FIG. 33;

FIG. 36 is a top plan view of the key chain of FIG. 33;

FIG. 37 is a bottom plan view of the key chain of FIG. 33;

FIG. 38 is a front elevational view of a key chain showing a eighth embodiment of the present invention showing a racket ornament. The rear elevational view is the same as FIG. 3;

FIG. 39 is a right-side elevational view of the key chain of FIG. 38;

FIG. 40 is a left-side elevational view of the key chain of FIG. 38;

FIG. 41 is a top plan view of the key chain of FIG. 38; and,

FIG. 42 is a bottom plan view of the key chain of FIG. 38.

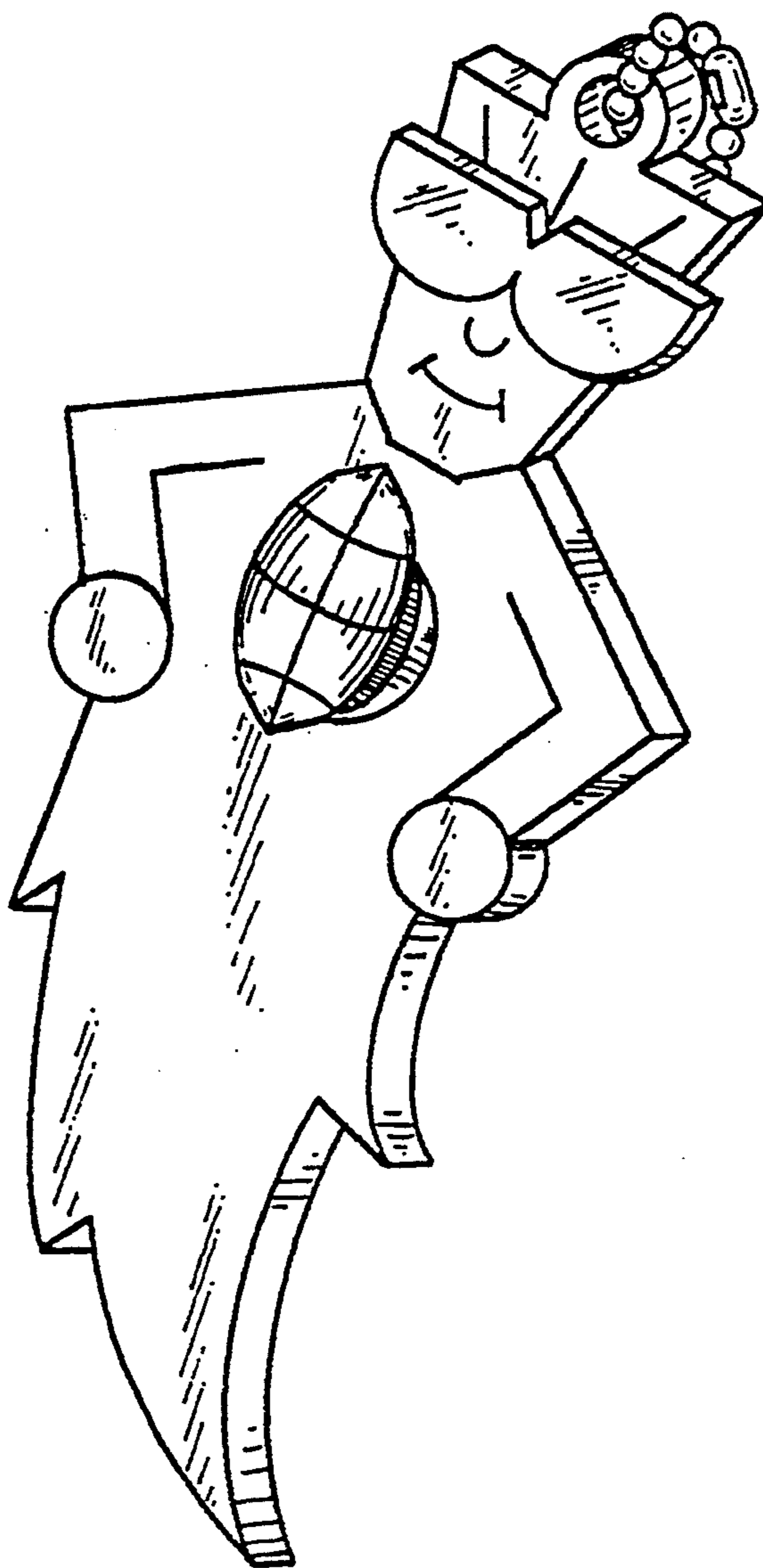

FIG. 1

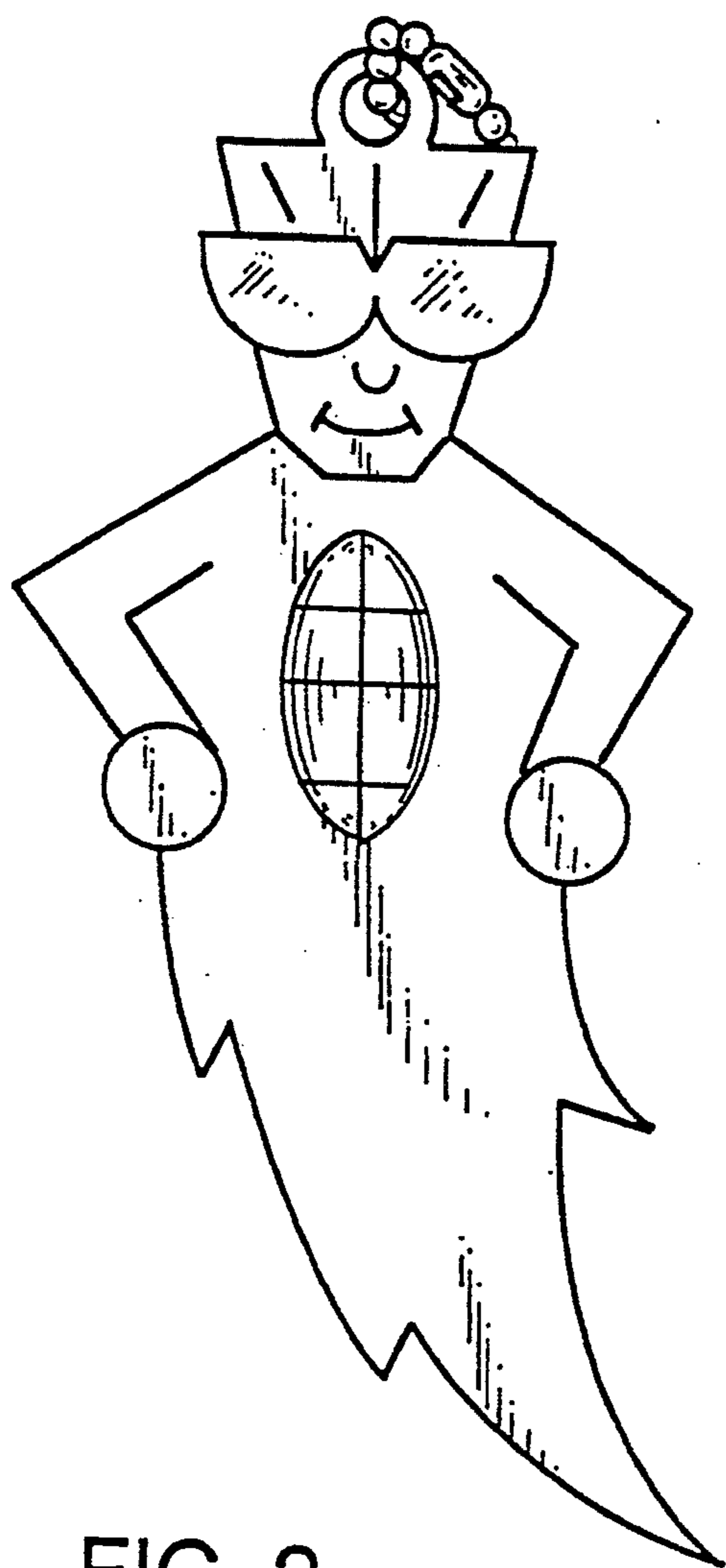

FIG. 2

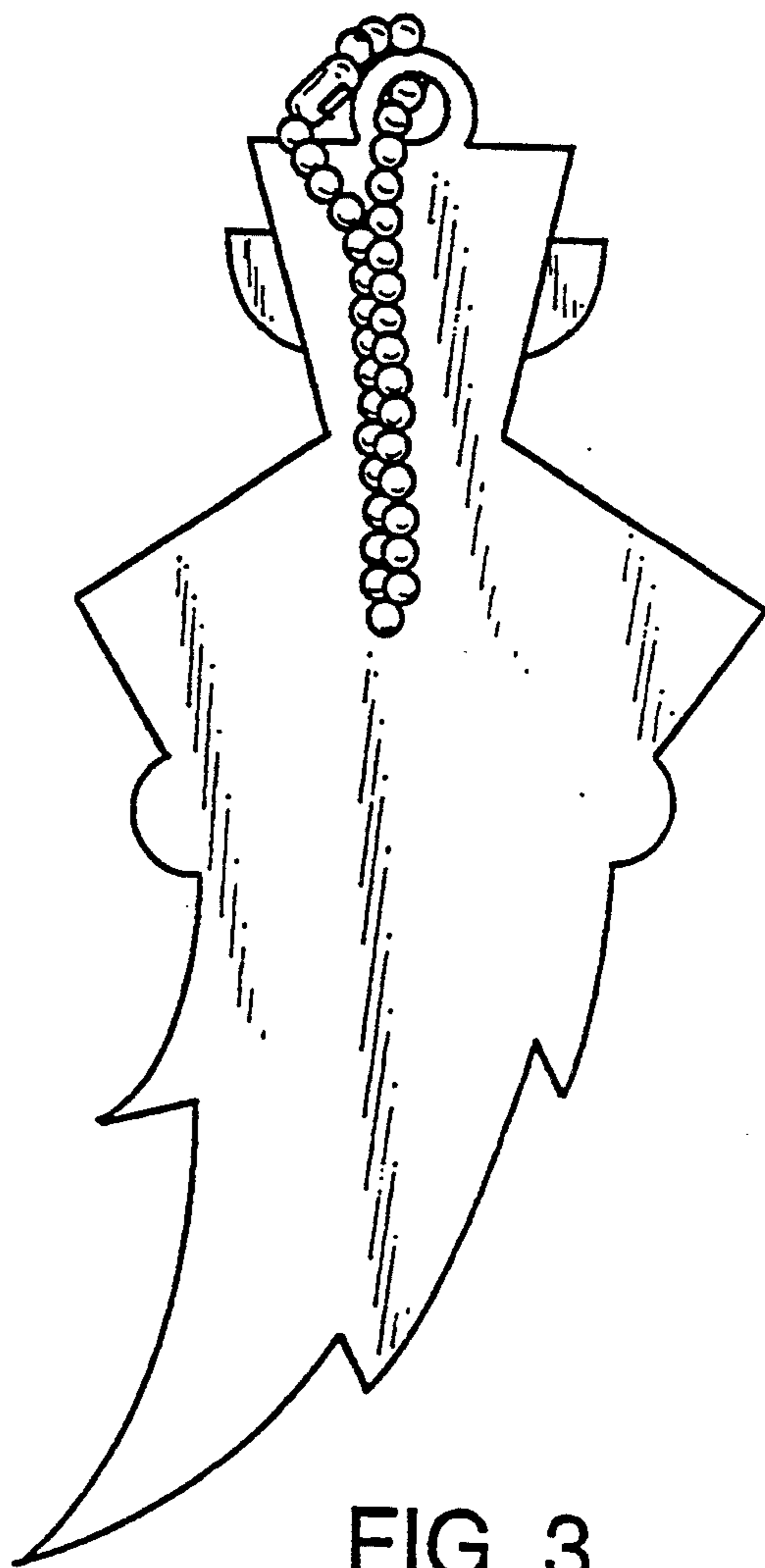

FIG. 3

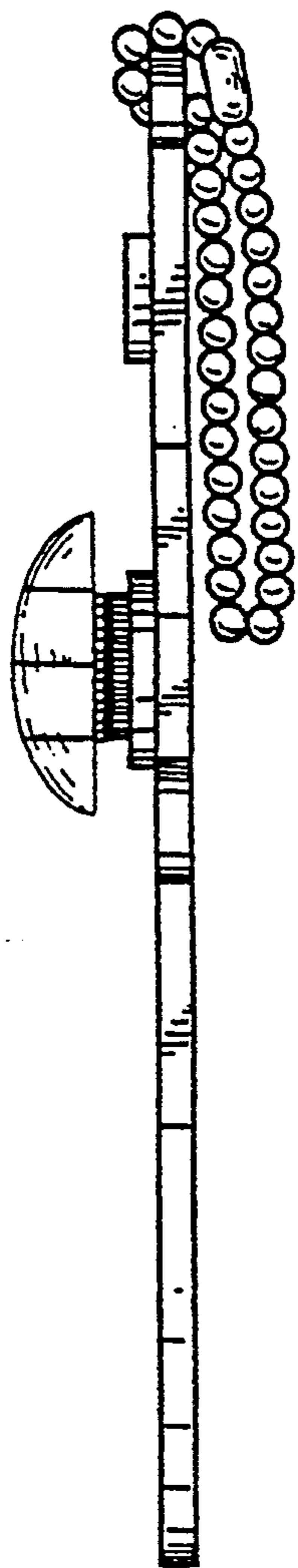

FIG. 4

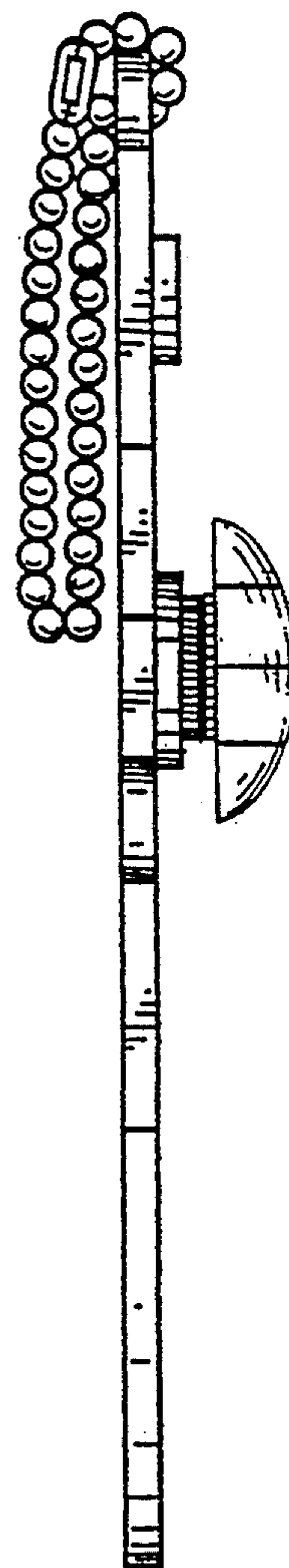

FIG. 5

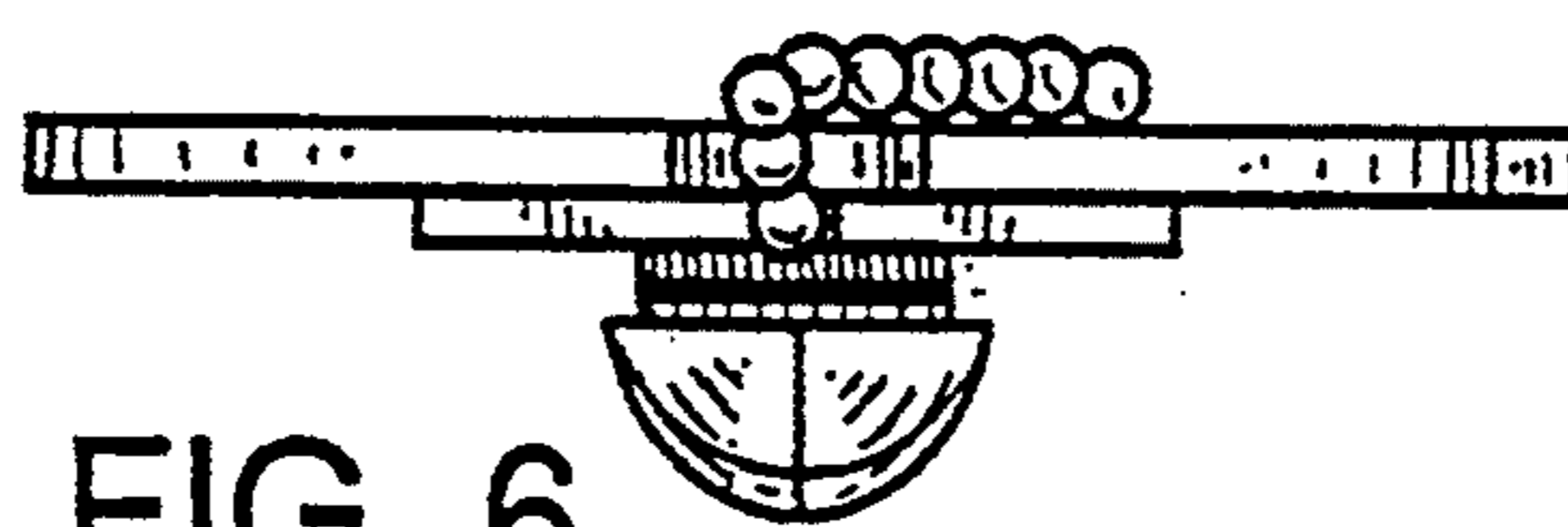

FIG. 6

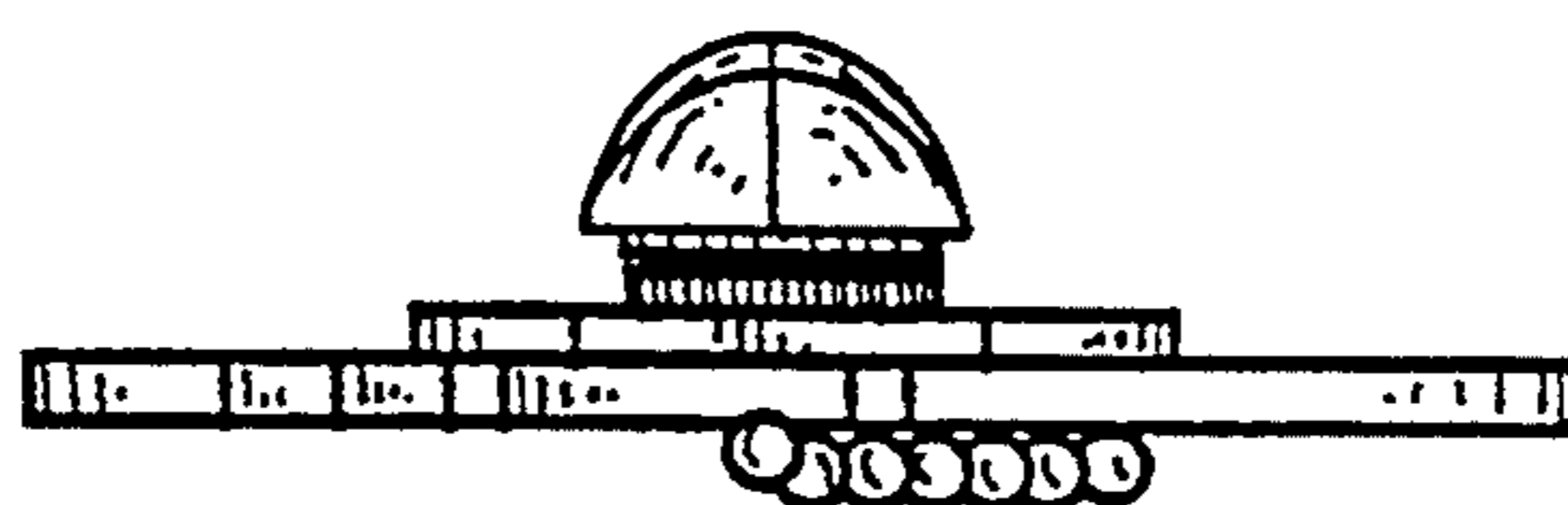

FIG. 7

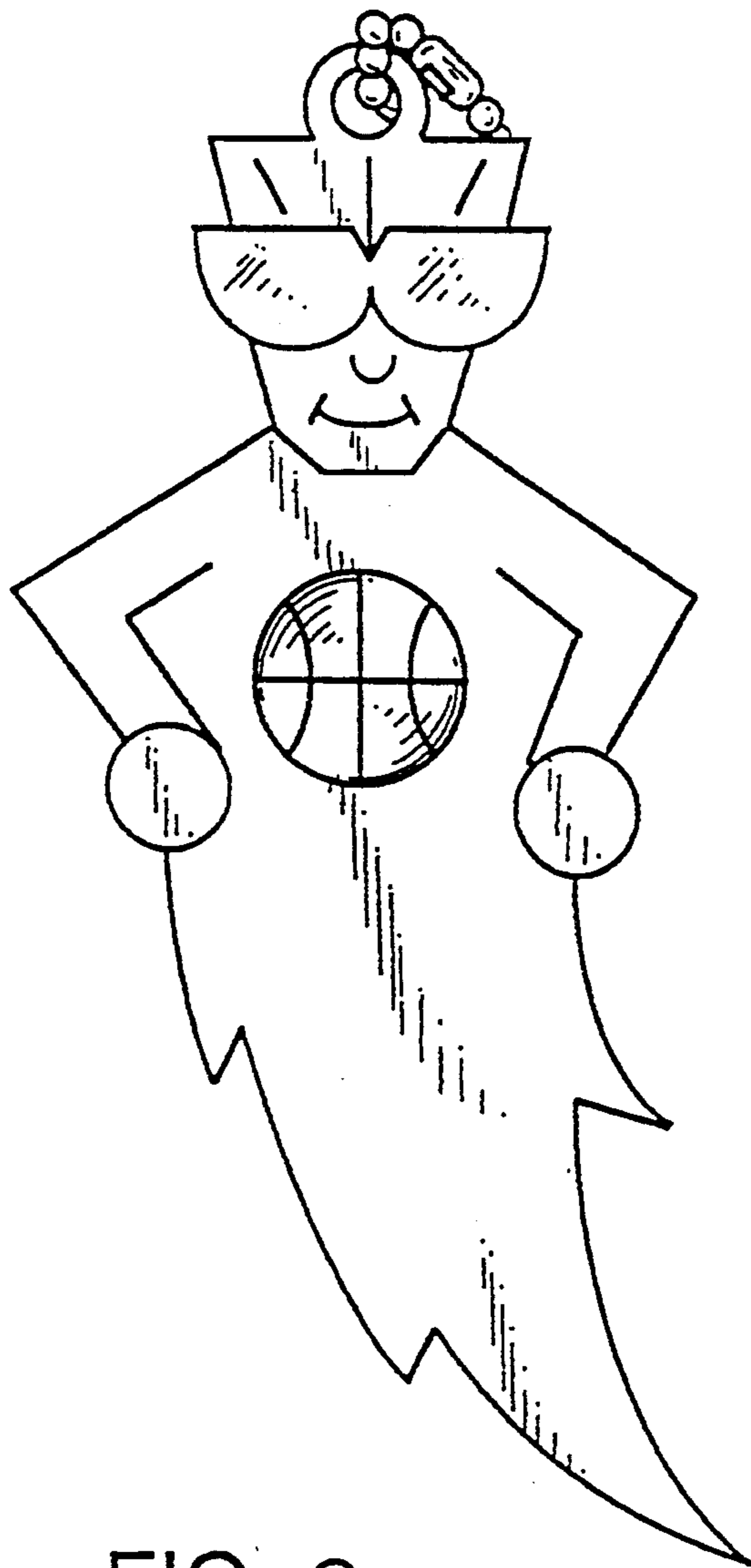

FIG. 8

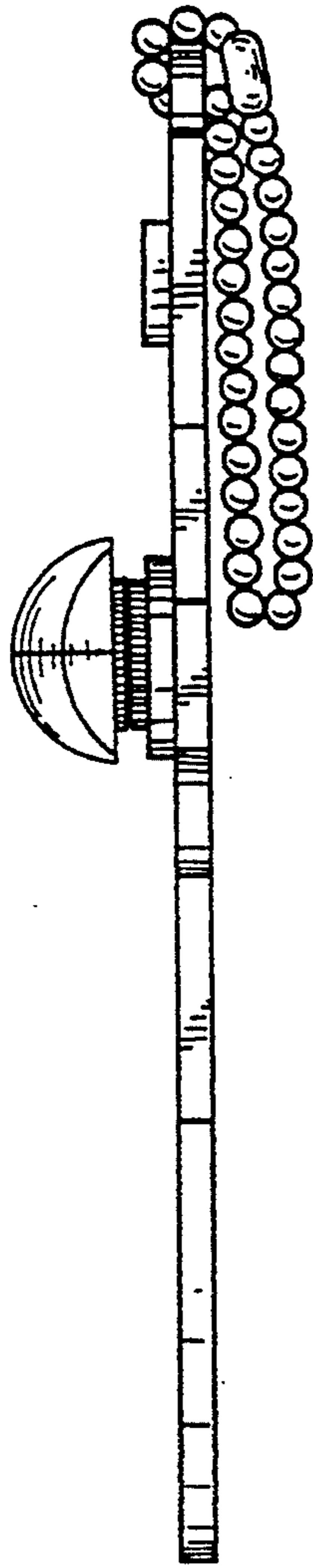

FIG. 9

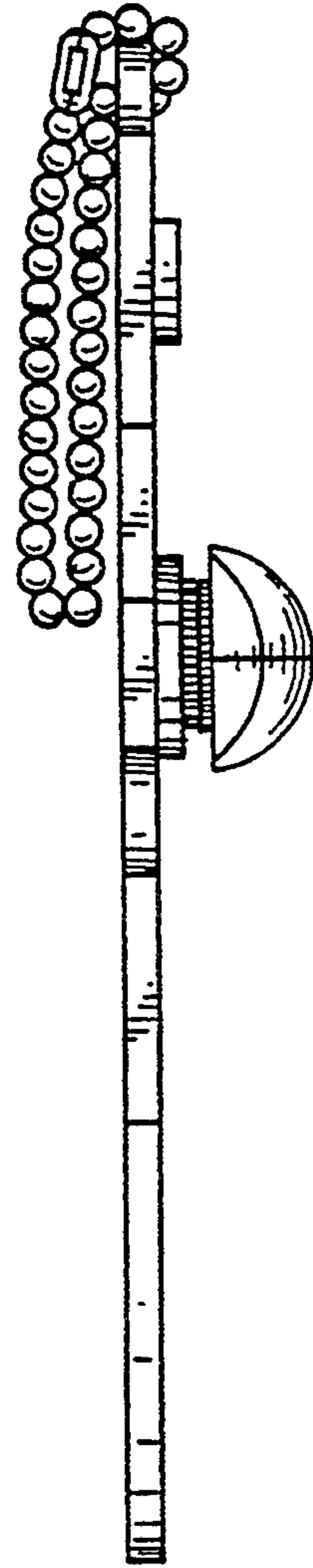

FIG. 10

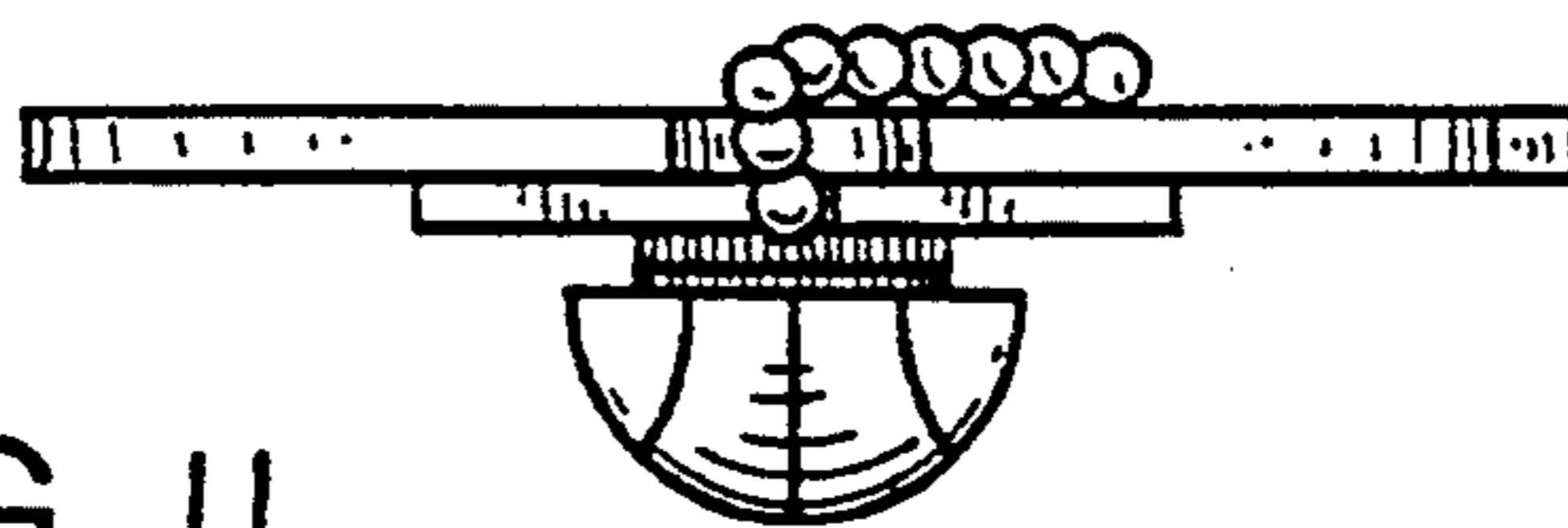

FIG. 11

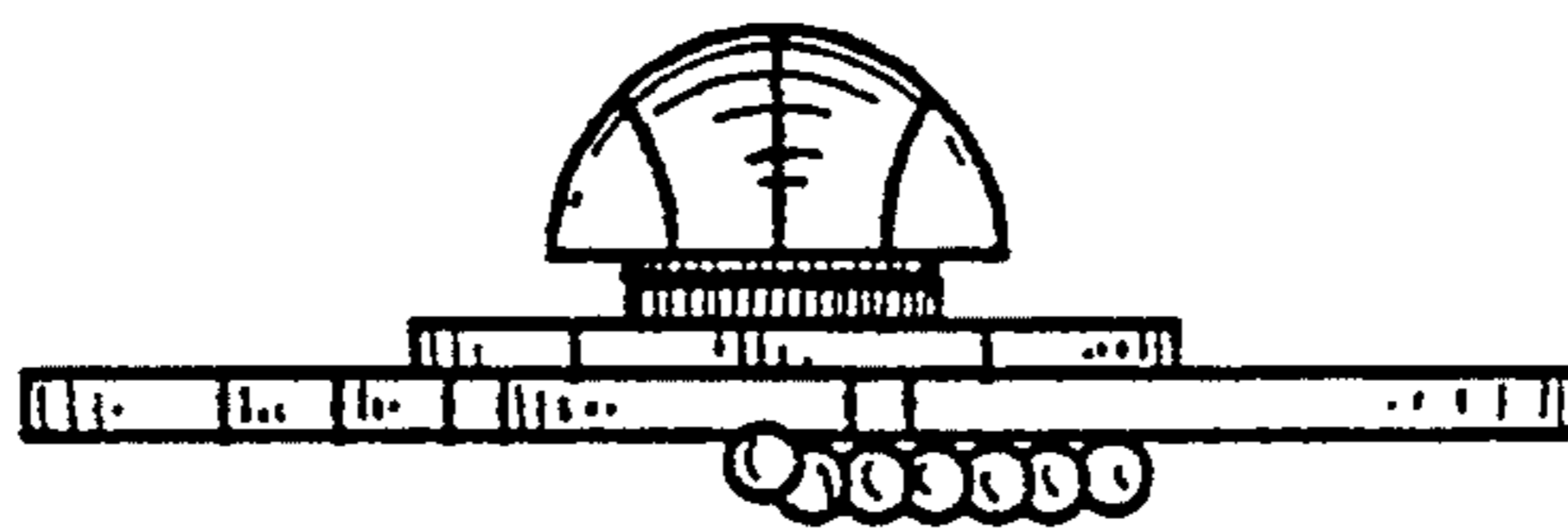

FIG. 12

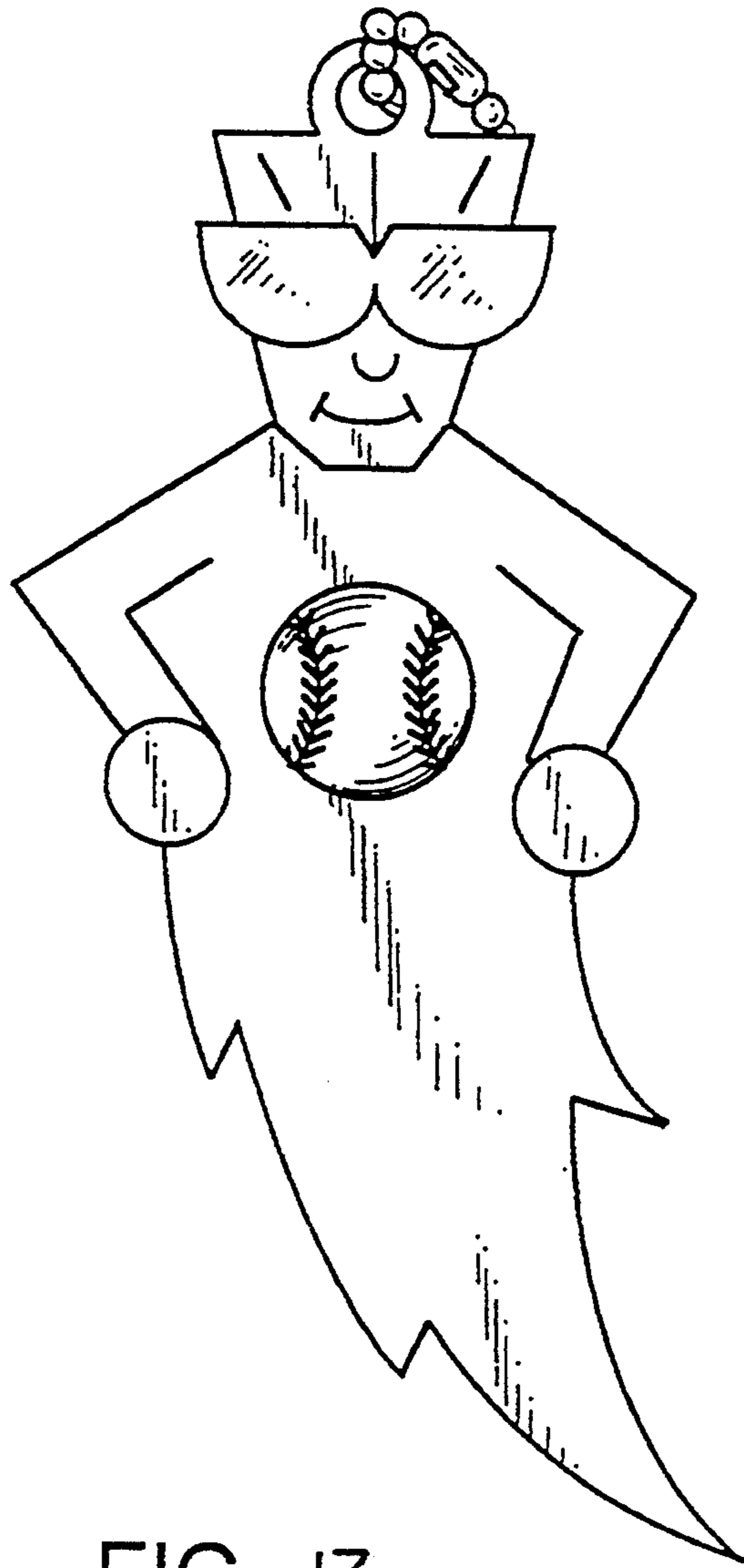

FIG. 13



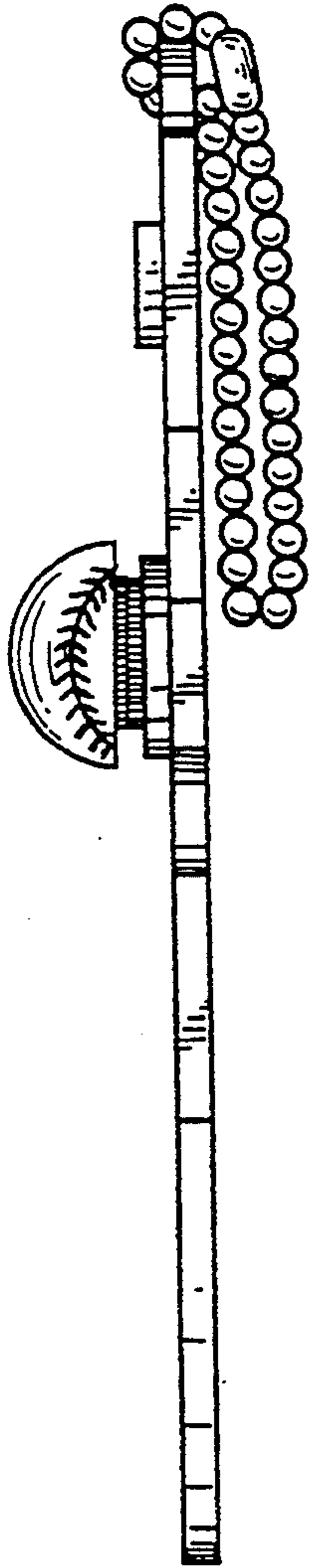

FIG. 14

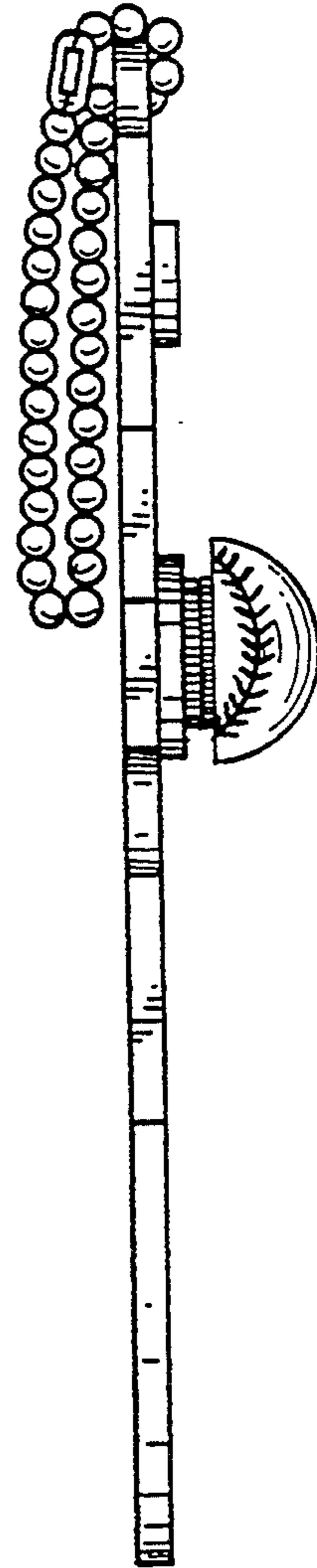

FIG. 15

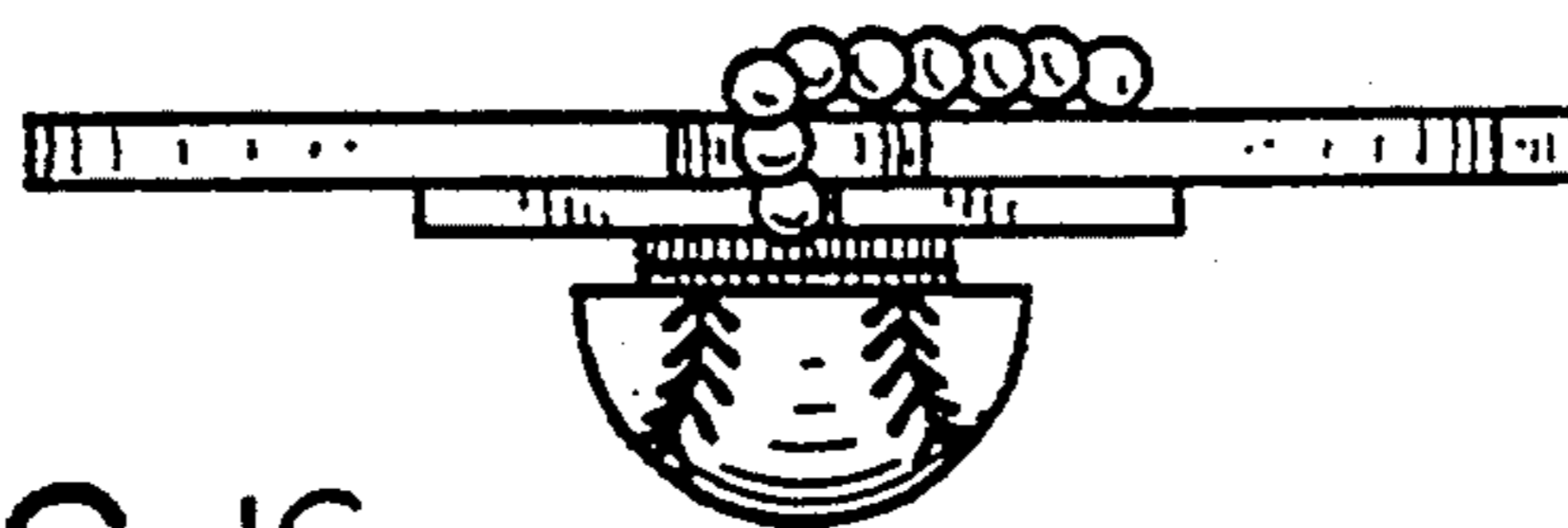

FIG. 16

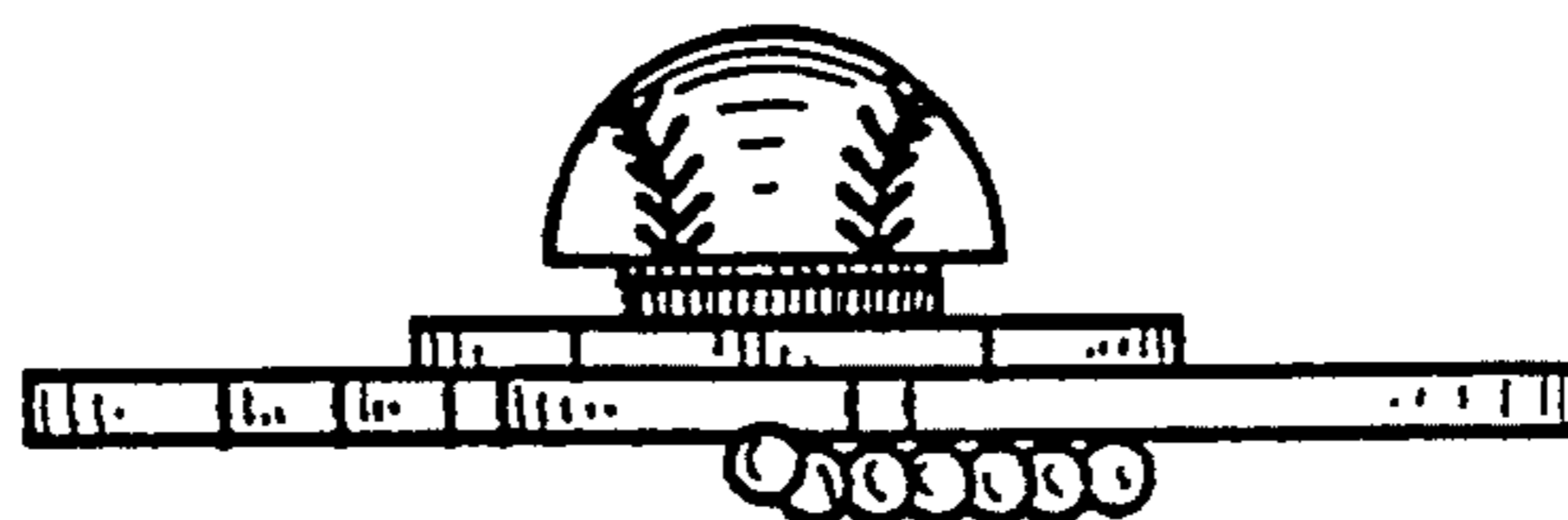

FIG. 17

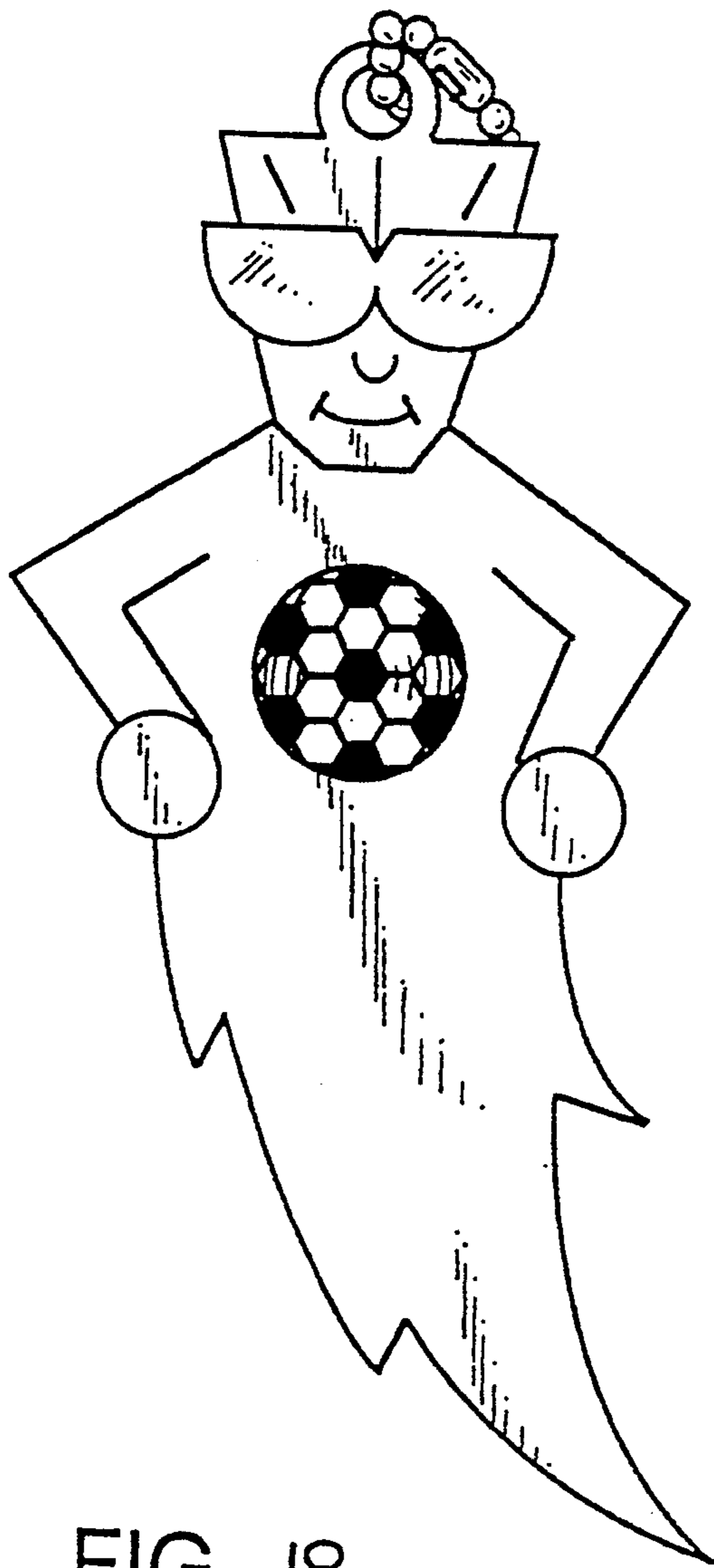

FIG. 18

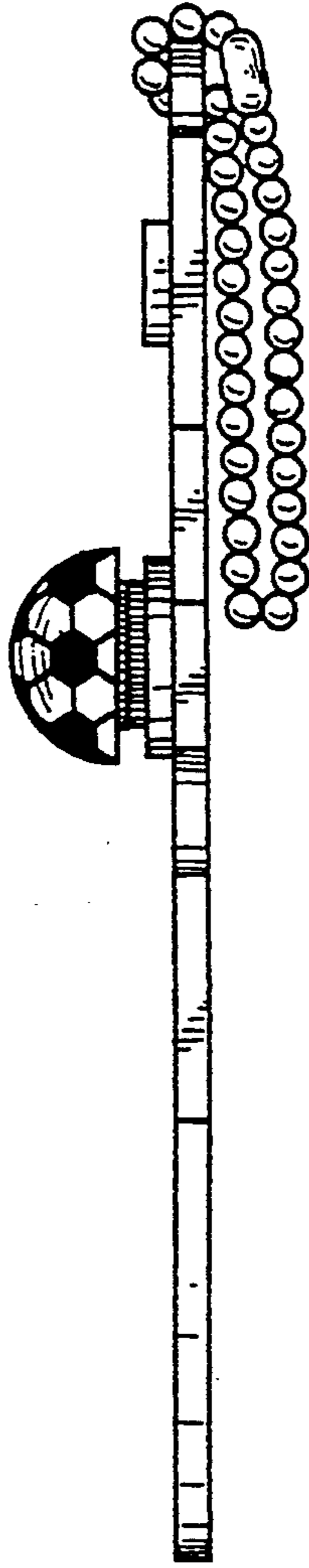

FIG. 19

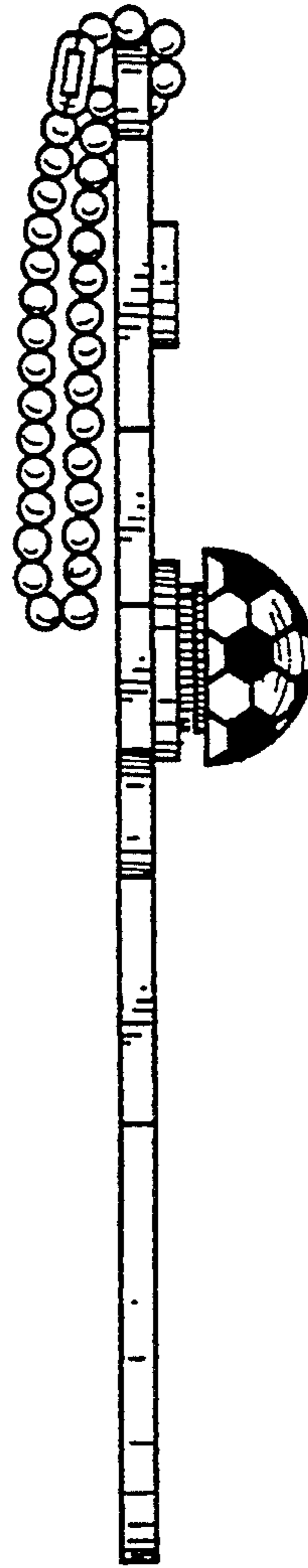

FIG. 20

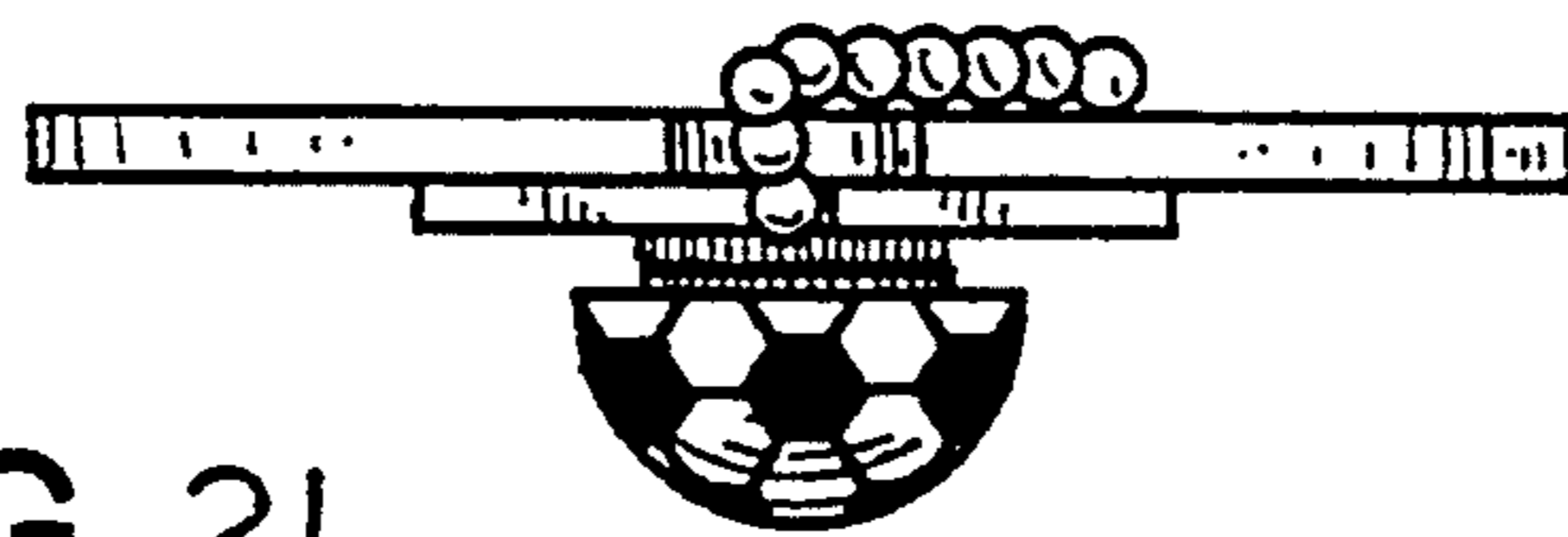

FIG. 21

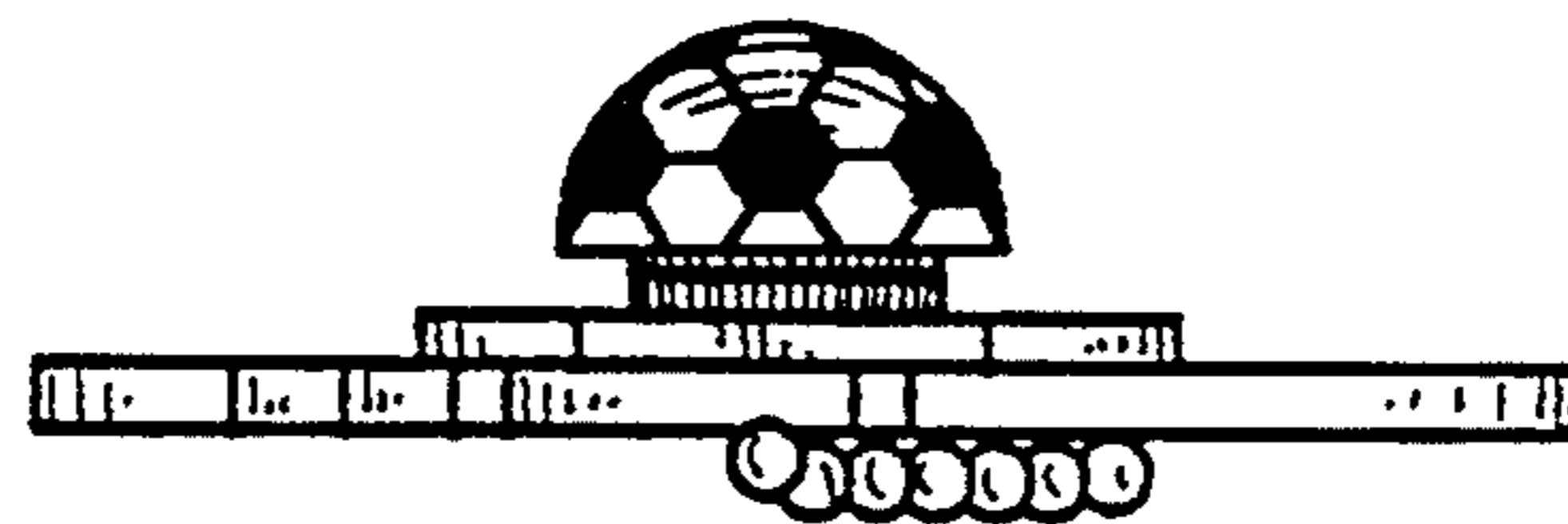

FIG. 22

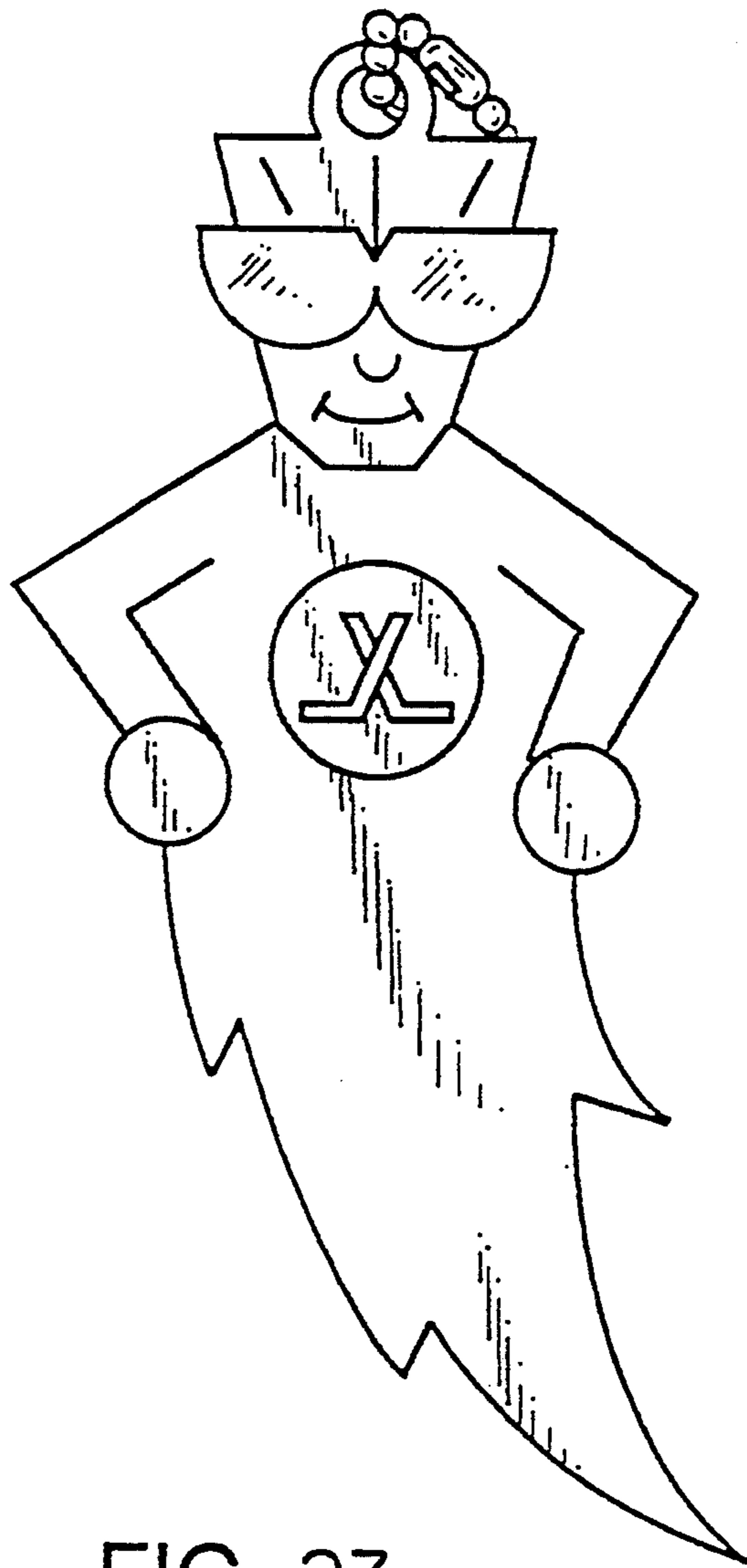

FIG. 23

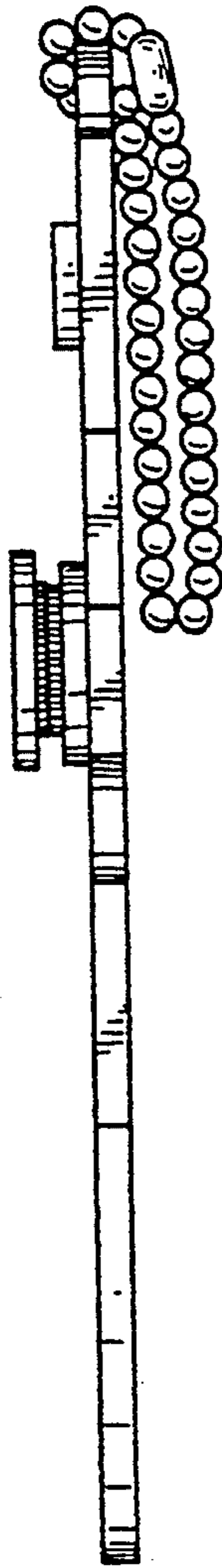

FIG. 24

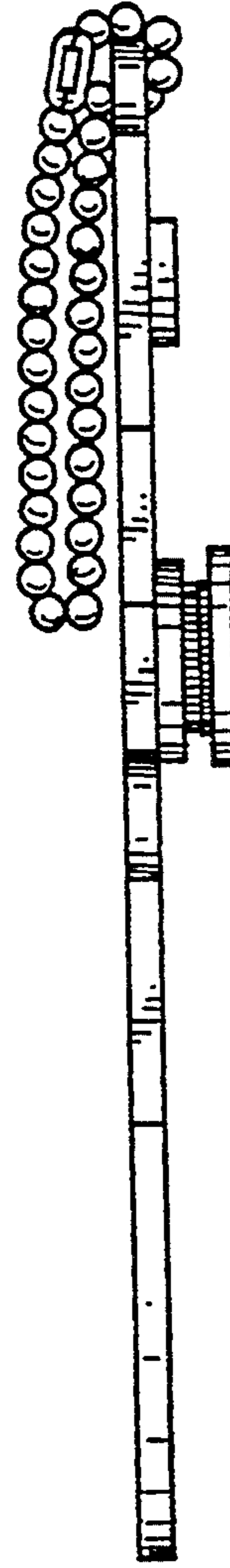

FIG. 25

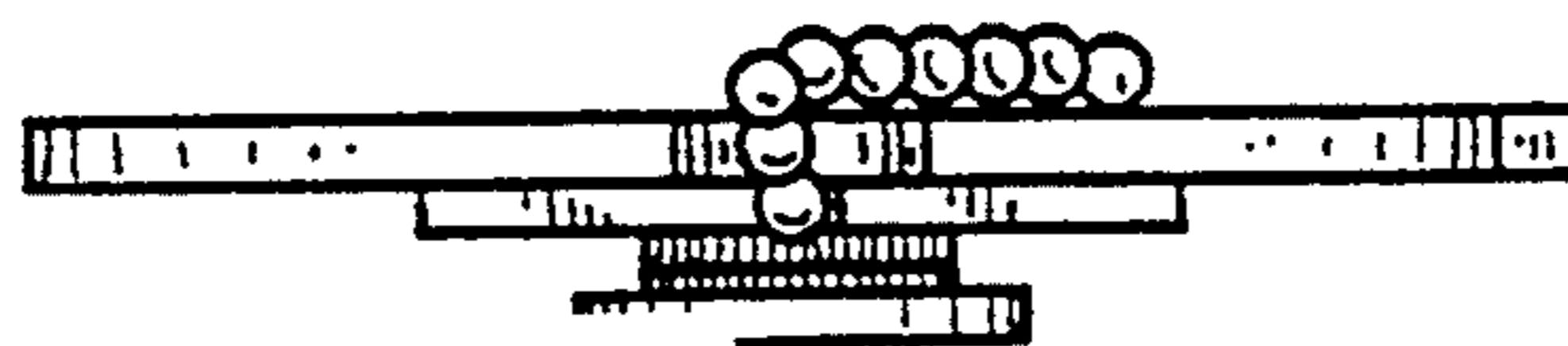

FIG. 26

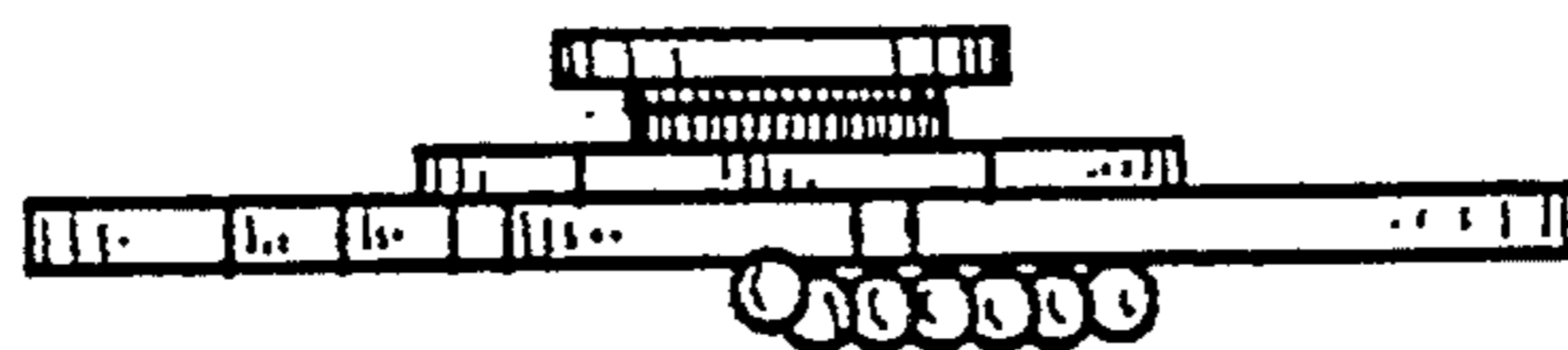

FIG. 27

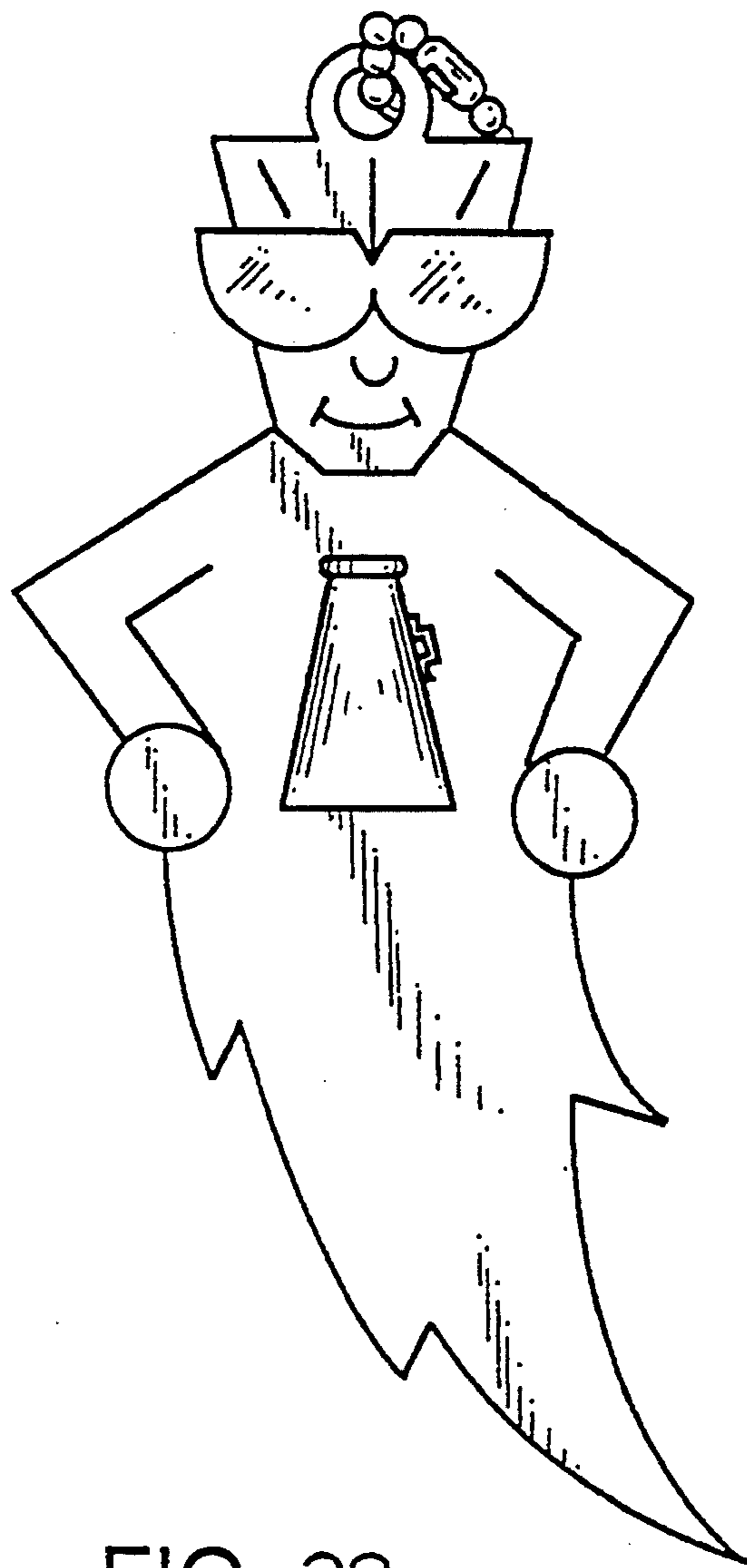

FIG. 28

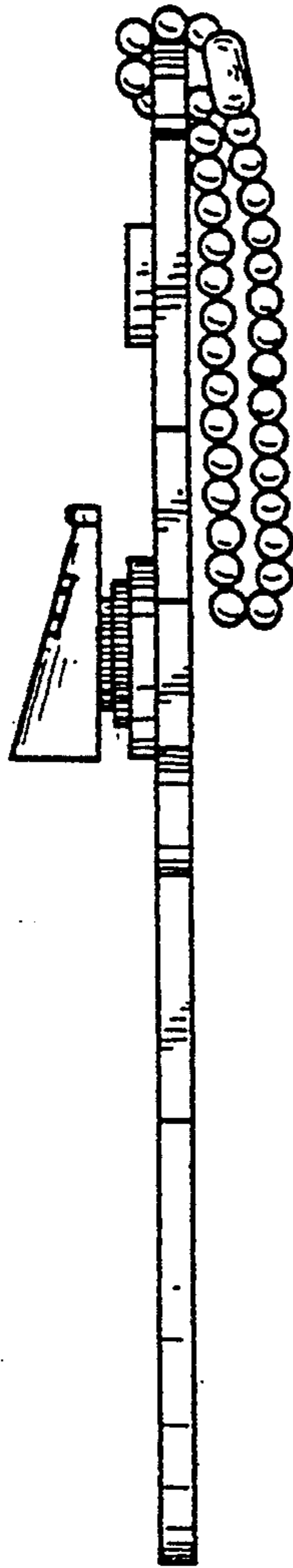

FIG. 29

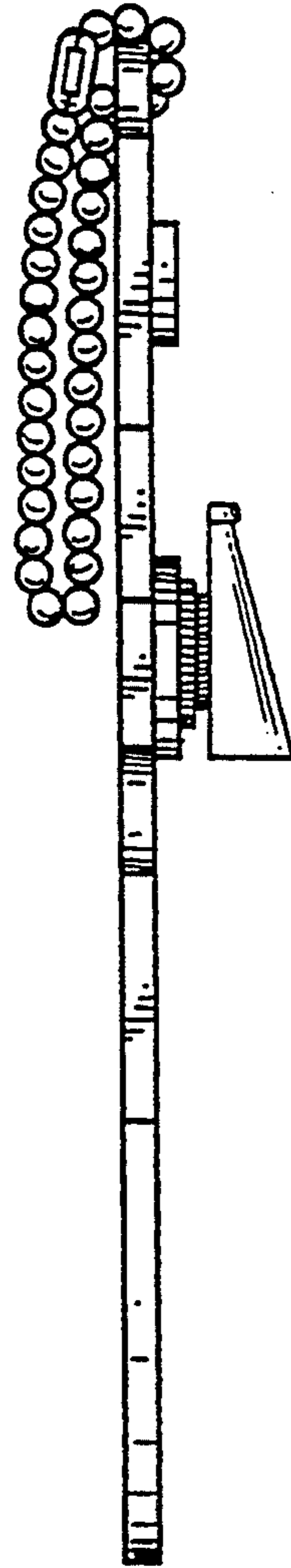

FIG. 30

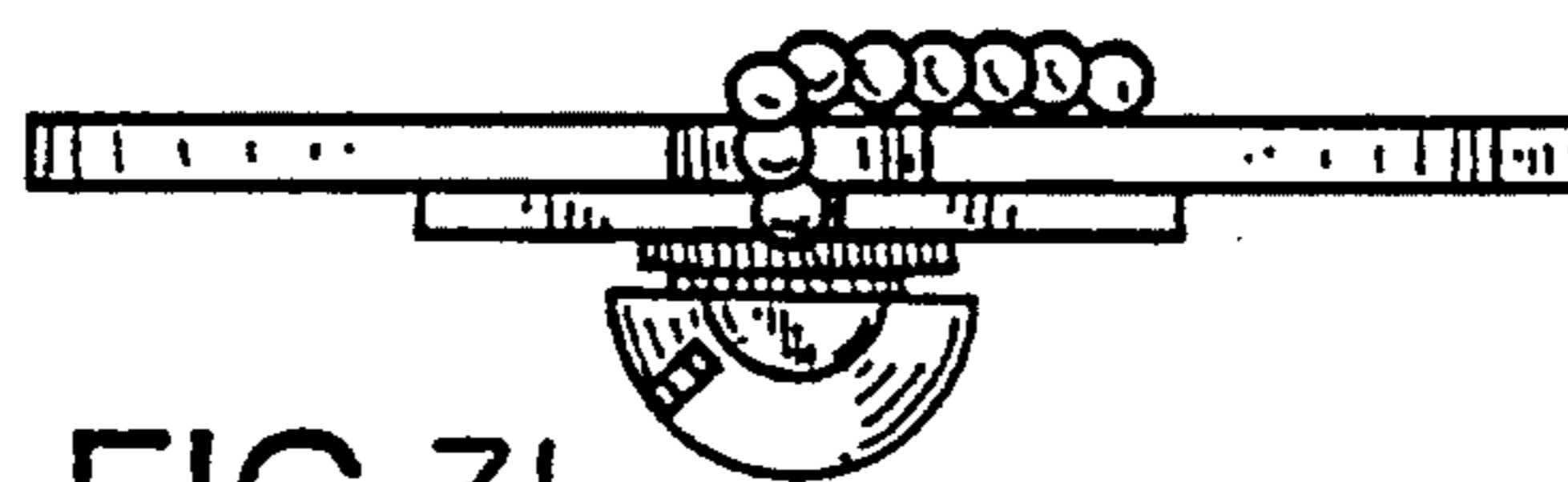

FIG. 31

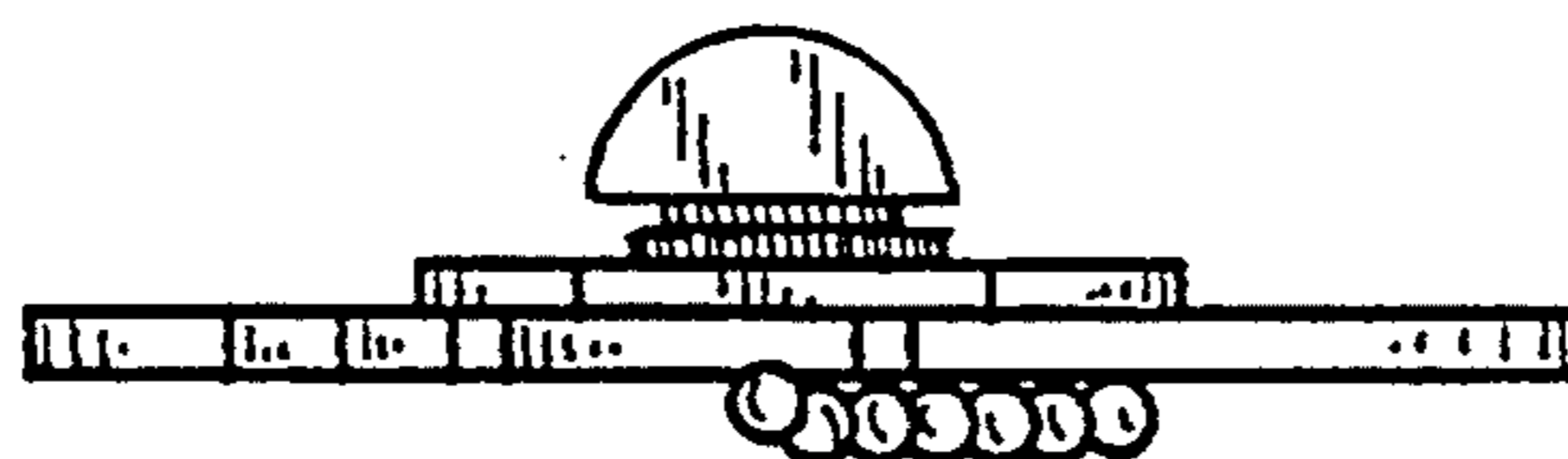

FIG. 32

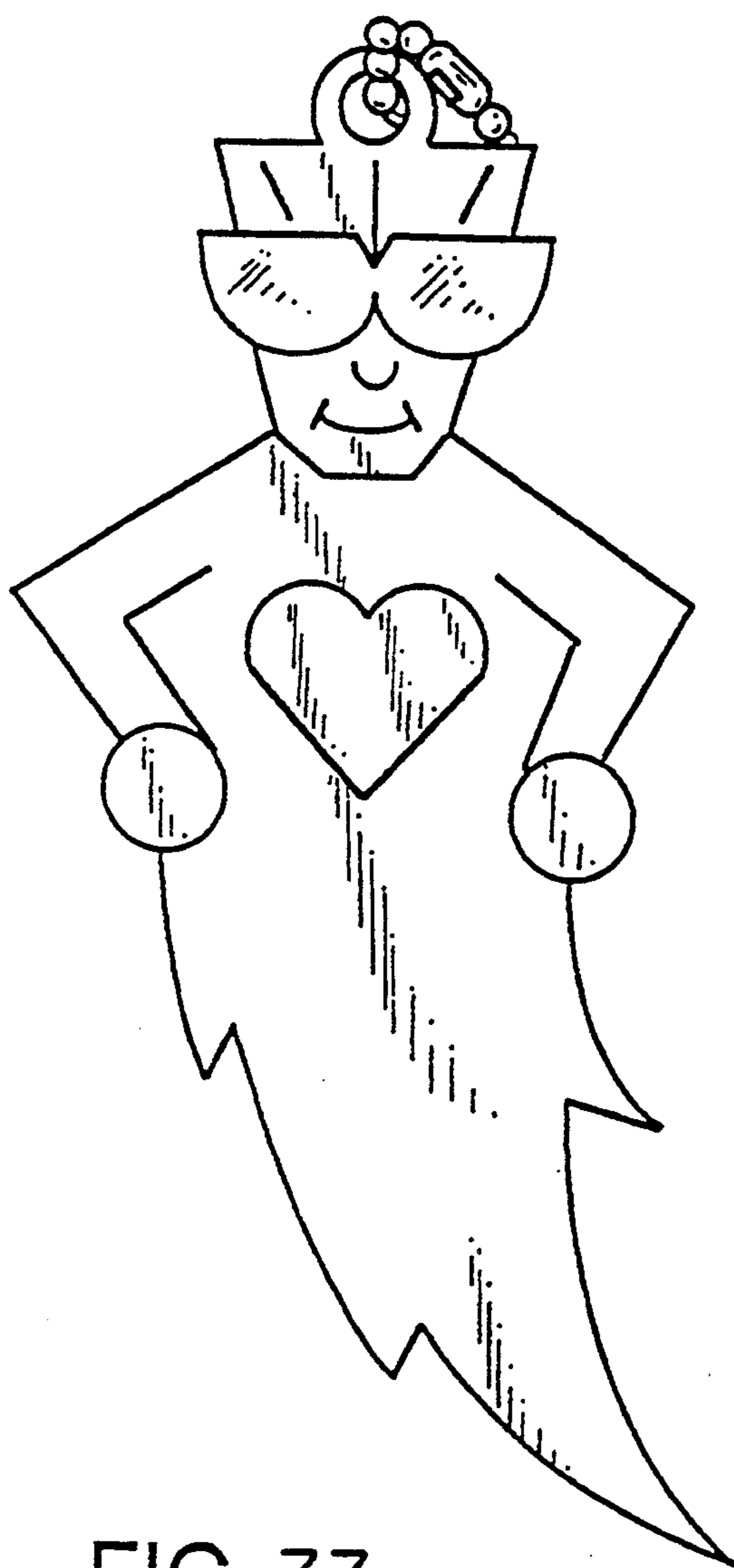

FIG. 33



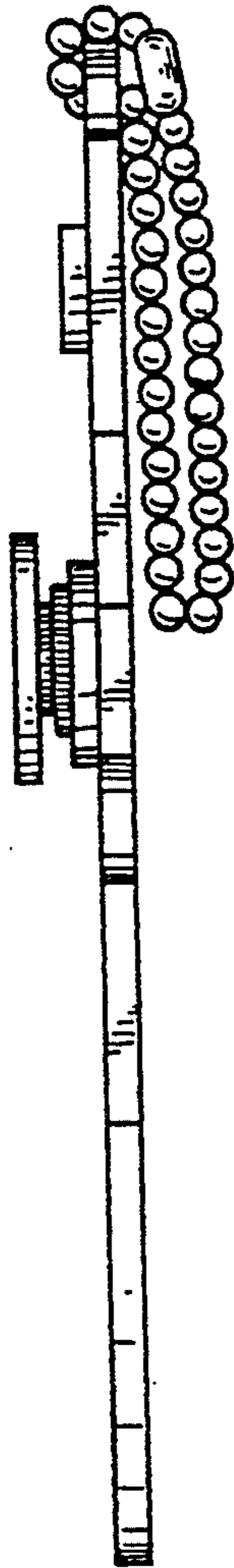

FIG. 34

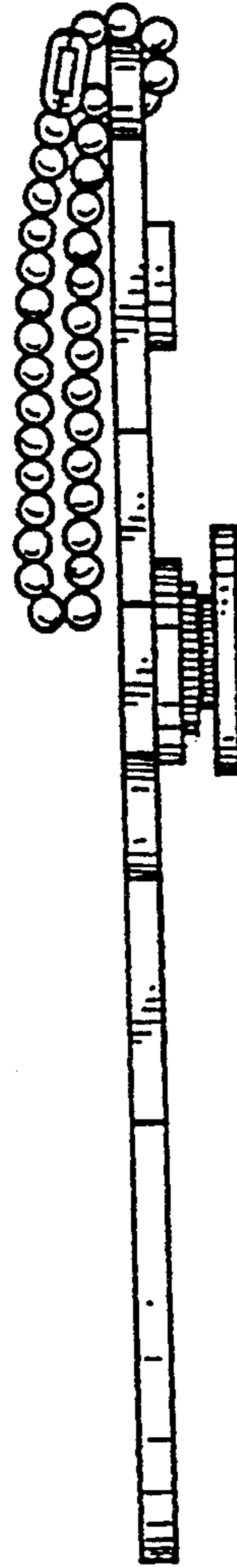

FIG. 35



FIG. 36

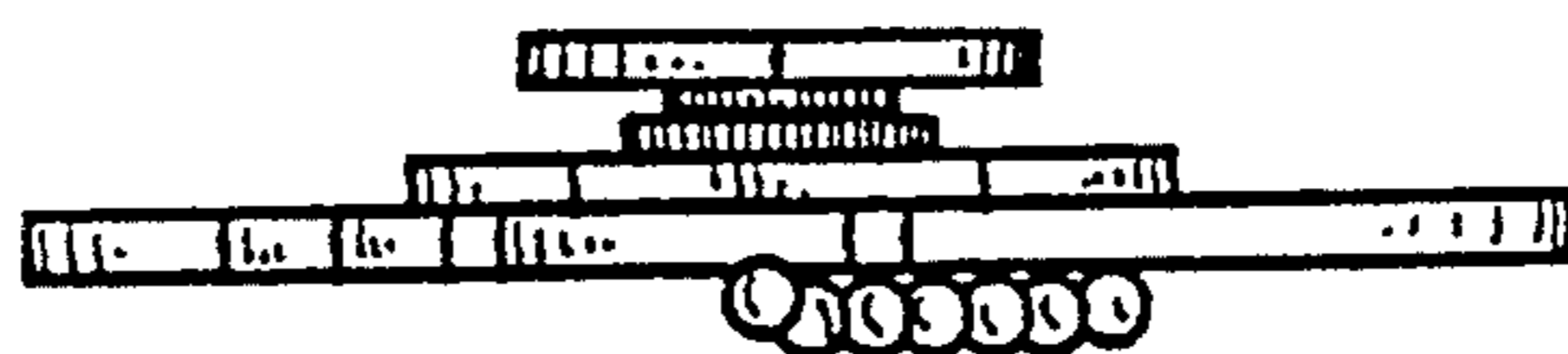

FIG. 37

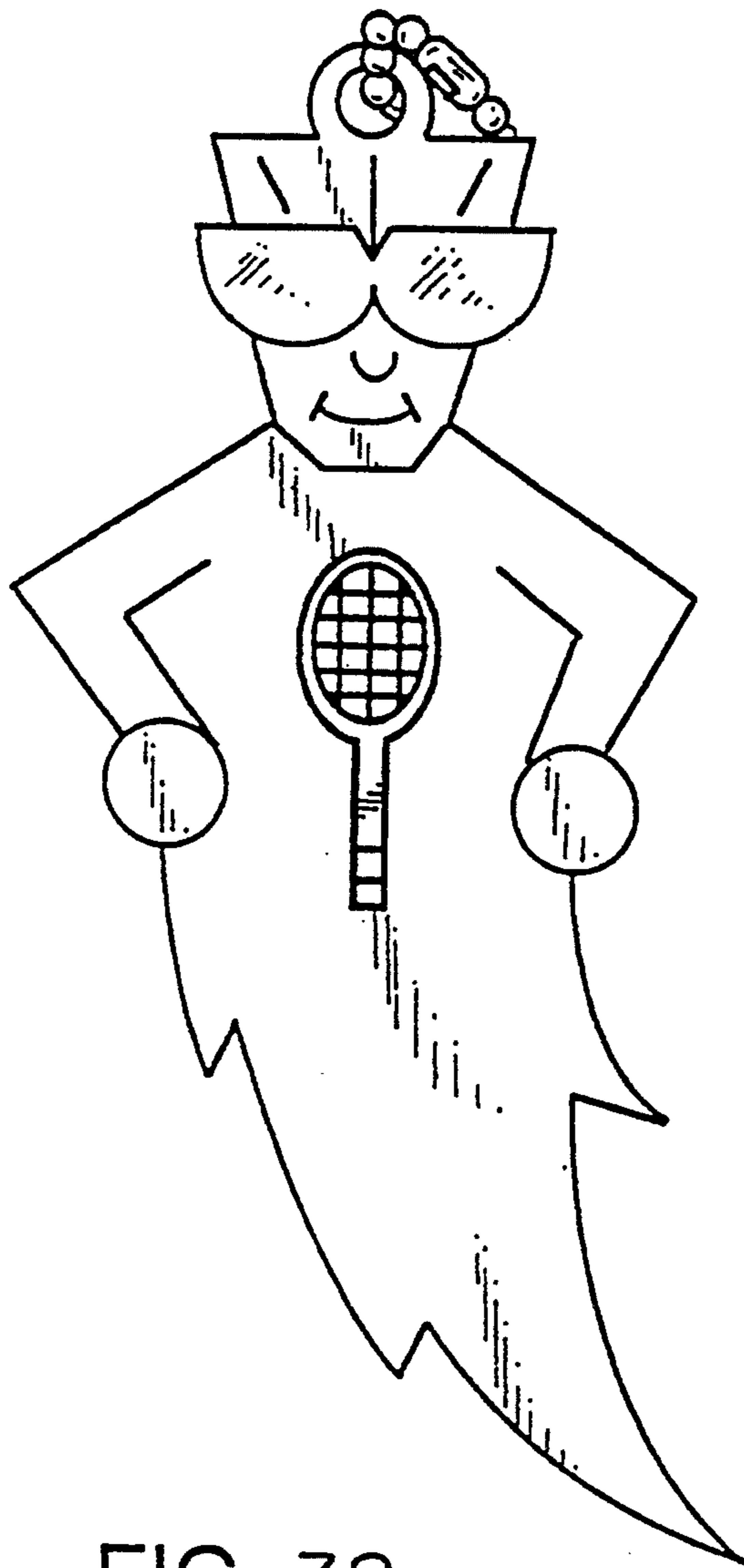

FIG. 38

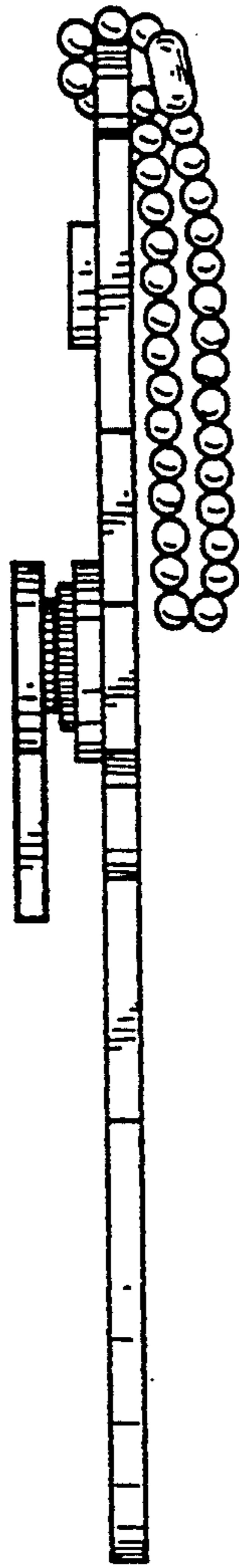

FIG. 39



FIG. 40



FIG. 41



FIG. 42