



US00D353164S

United States Patent [19]

Meei-Lin

[11] Patent Number: **Des. 353,164**

[45] Date of Patent: **** Dec. 6, 1994**

[54] **TOY ANIMAL SHELTER**

[76] Inventor: **Liou Meei-Lin**, No. 318, 8th Flr., Fu Shbng Rd., Sec. 3, Taichung, Taiwan, Prov. of China

[**] Term: **14 Years**

[21] Appl. No.: **10,278**

[22] Filed: **Jul. 6, 1993**

[52] U.S. Cl. **D21/59; D21/105**

[58] Field of Search **434/195, 204, 215, 259; D21/59, 105, 107, 114; D19/59**

[56] **References Cited**

U.S. PATENT DOCUMENTS

- D. 194,617 2/1963 Markham D21/105 X
- D. 222,999 2/1972 Tachi D21/107
- D. 271,898 12/1983 Flees D21/105

- D. 276,171 10/1984 Filipowicz D21/59
- D. 319,082 8/1991 Harris D21/107

Primary Examiner—Bernard Ansher
Assistant Examiner—Dominic Simone

[57] **CLAIM**

The ornamental design for a toy animal shelter, as shown.

DESCRIPTION

FIG. 1 is a perspective view of a toy animal shelter showing my new design;
 FIG. 2 is a front elevational view thereof;
 FIG. 3 is a rear elevational view thereof;
 FIG. 4 is a left elevational view thereof;
 FIG. 5 is a right elevational view thereof;
 FIG. 6 is a top plan view thereof; and,
 FIG. 7 is a bottom plan view thereof.

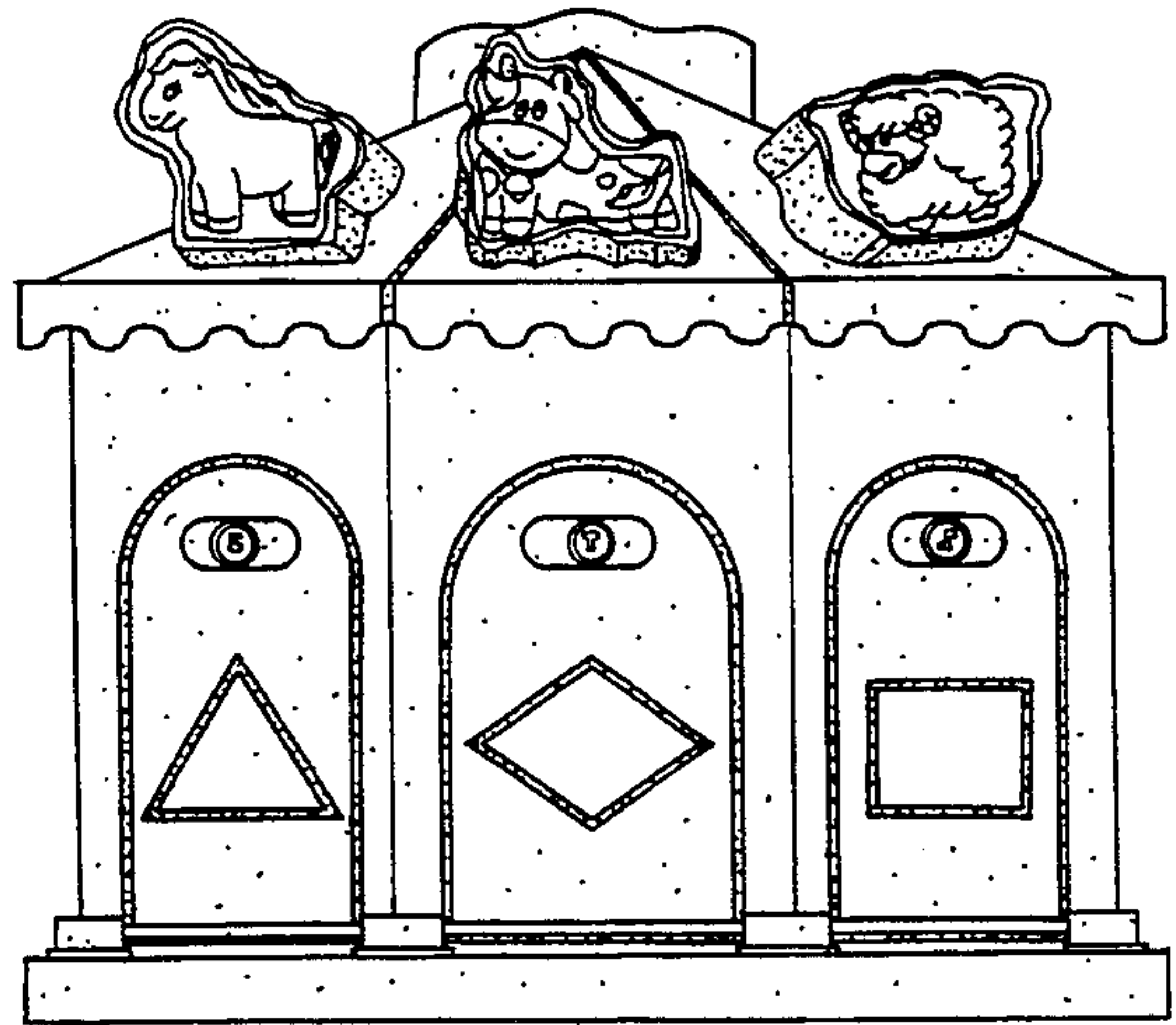
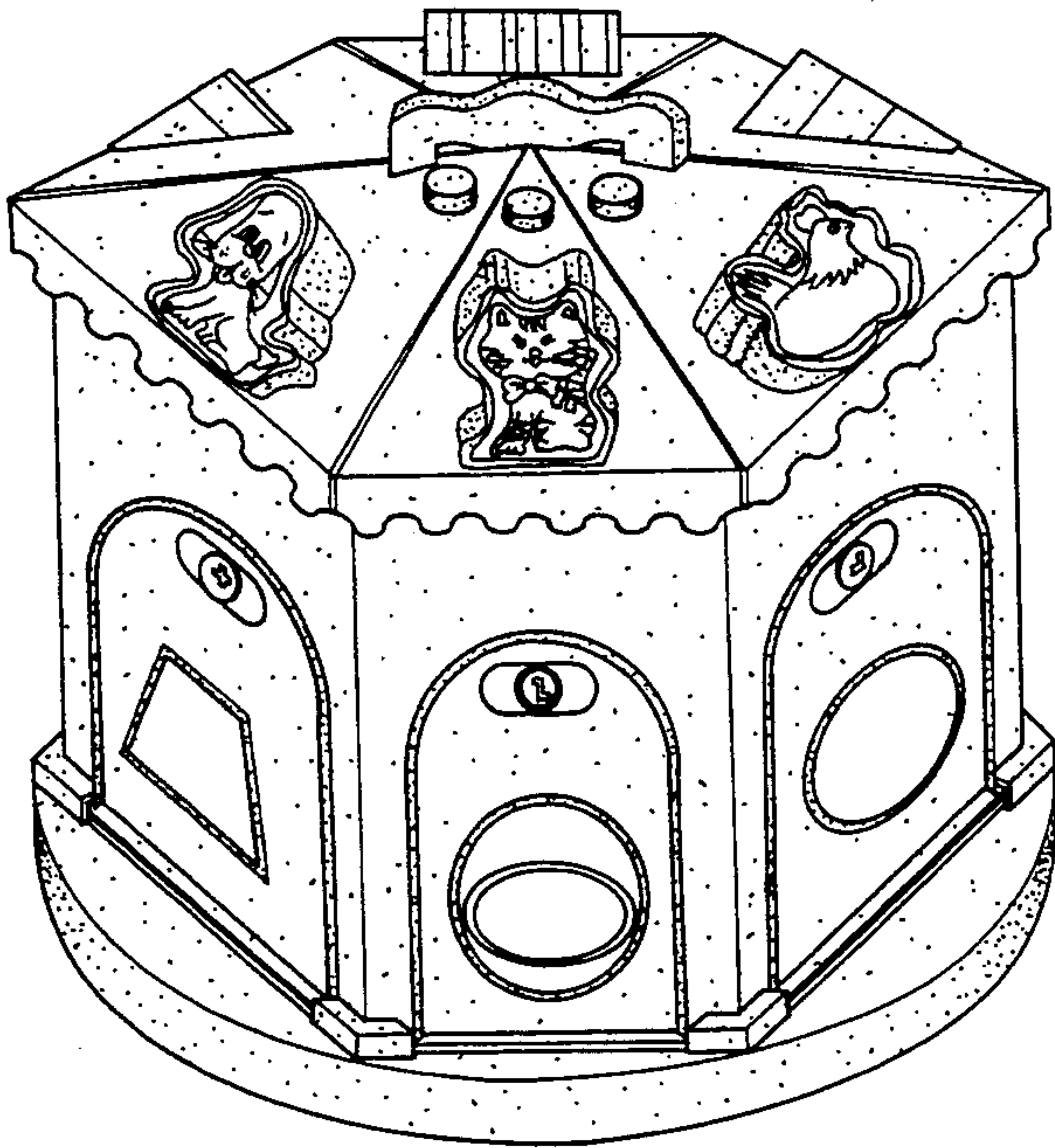

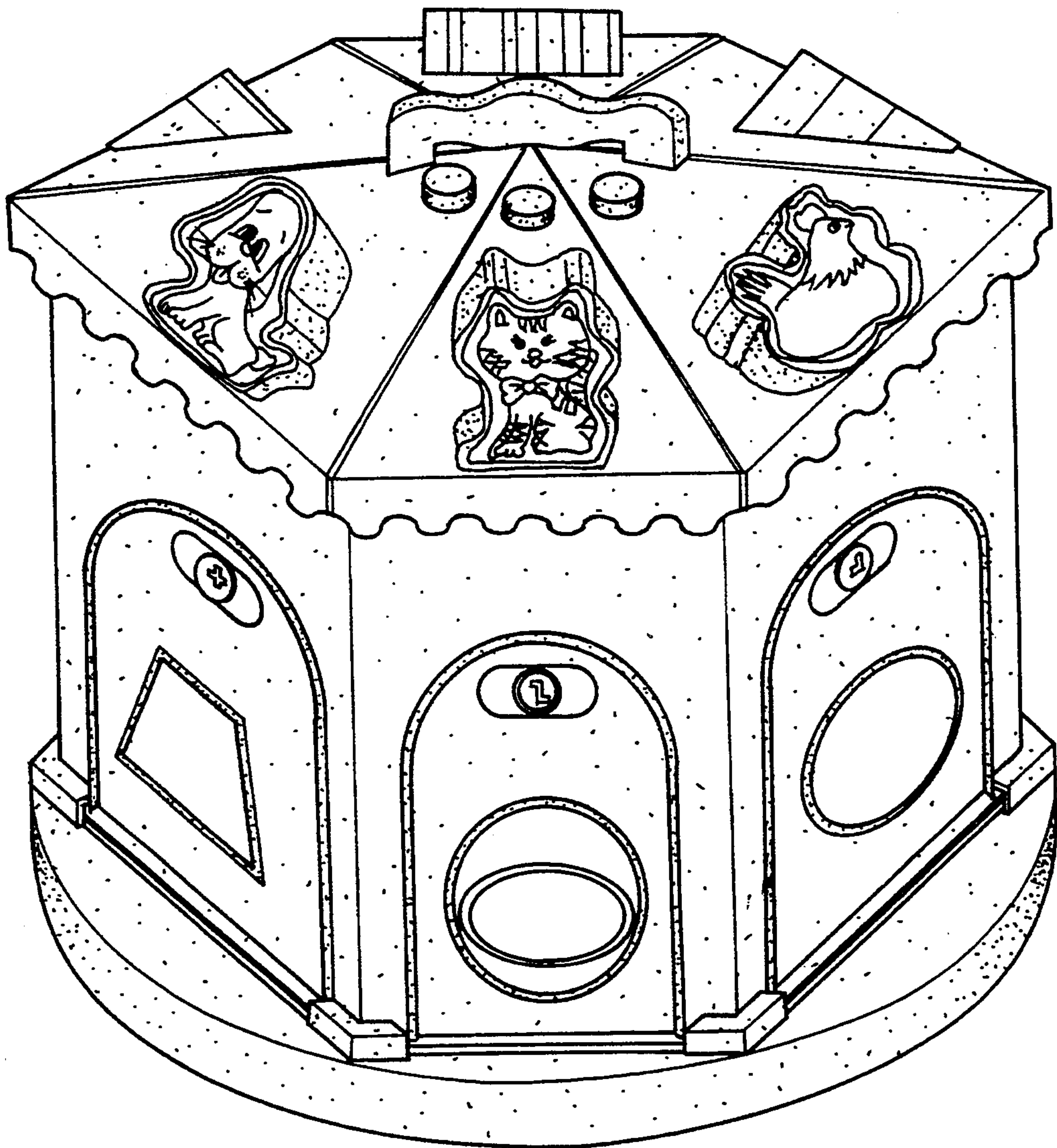

FIG. 1

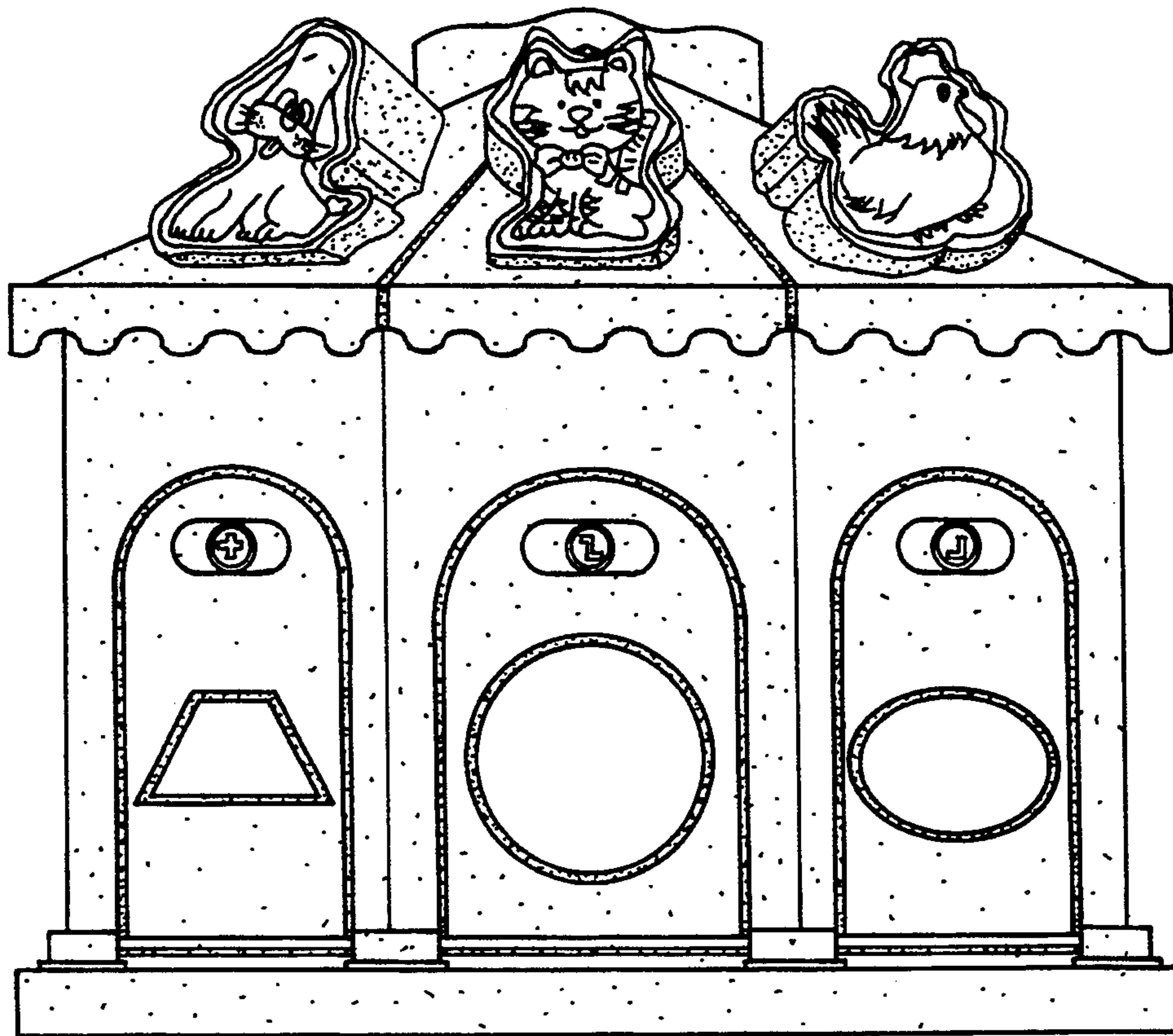

FIG. 2

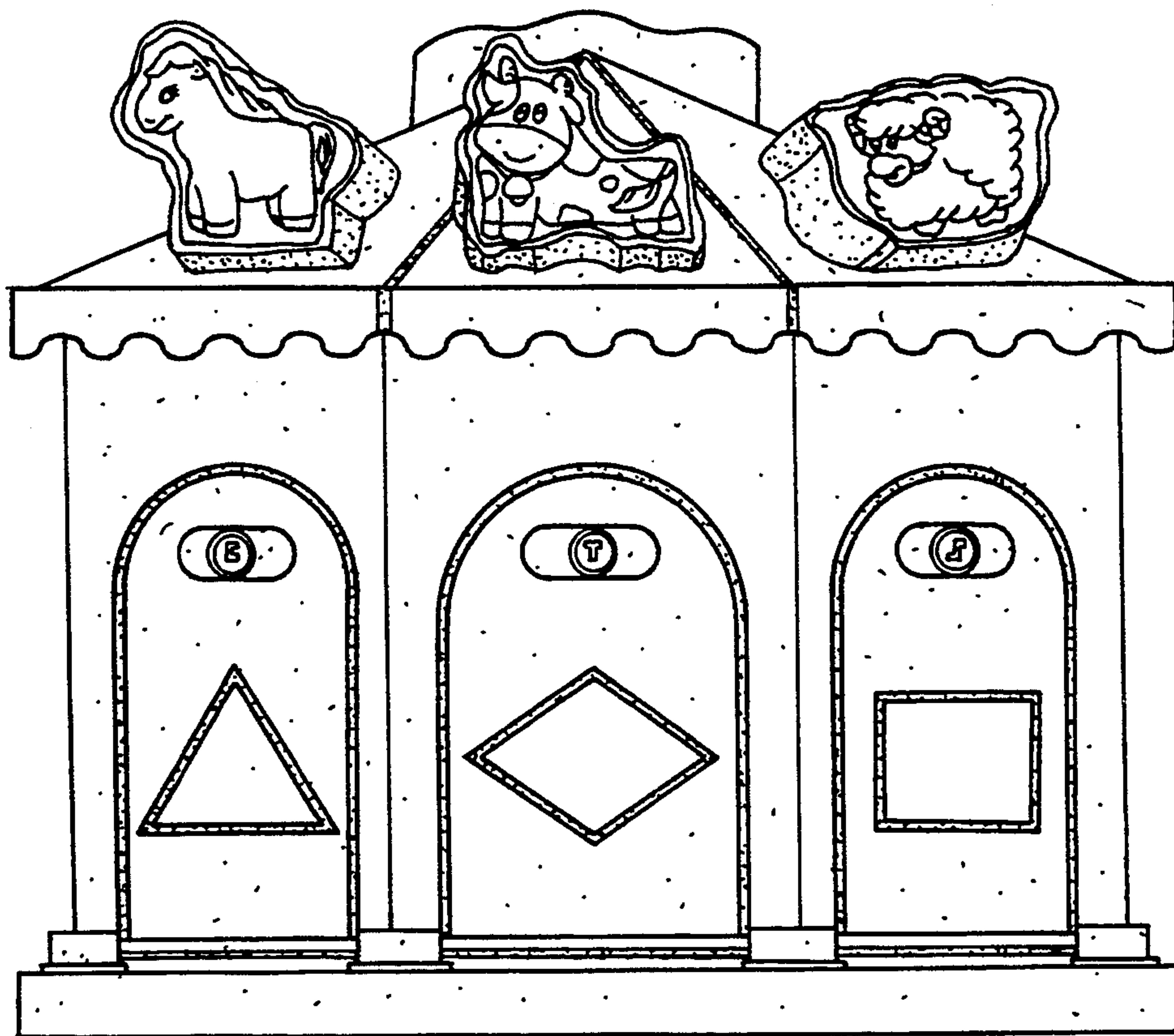

FIG. 3

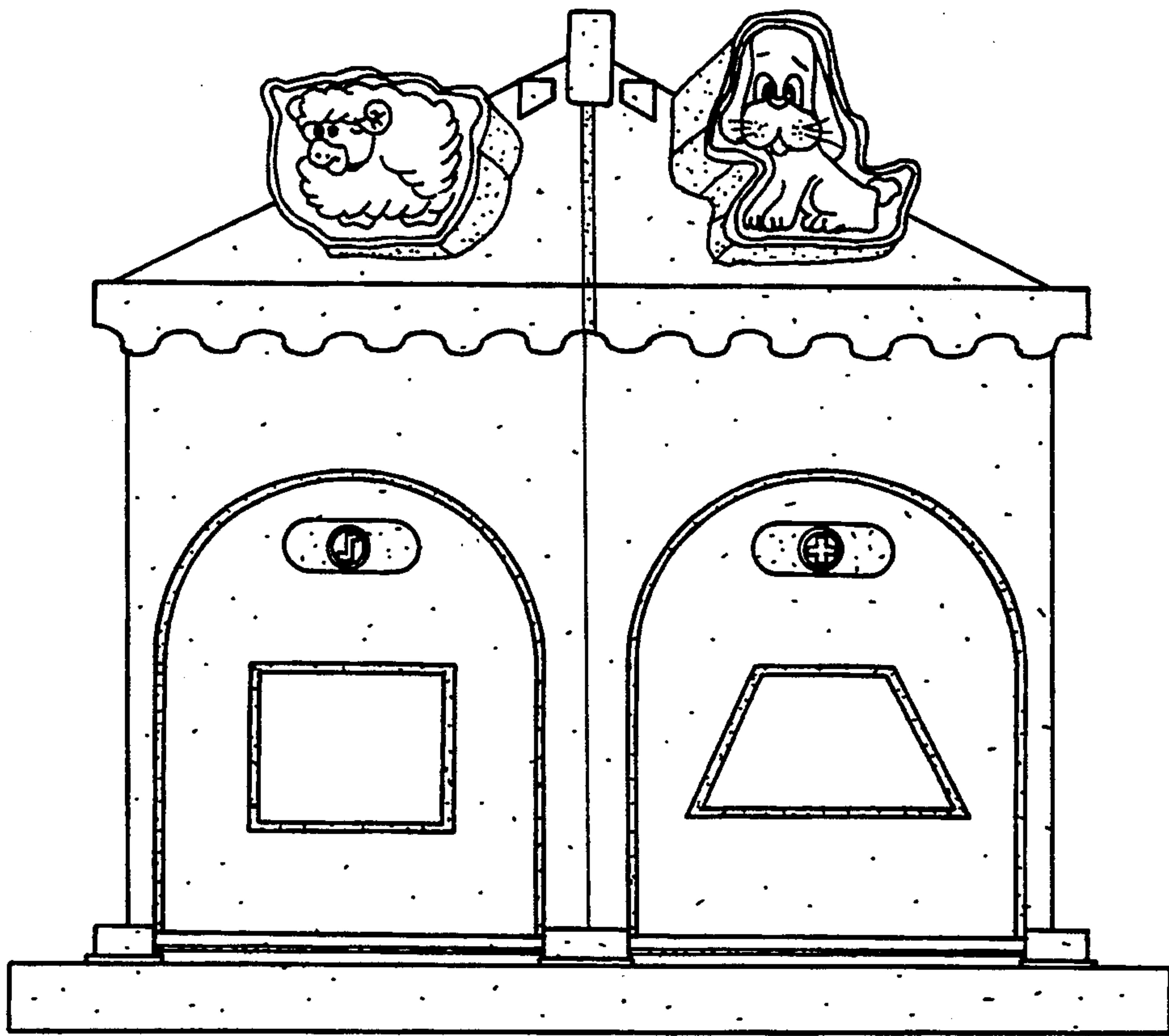

FIG. 4

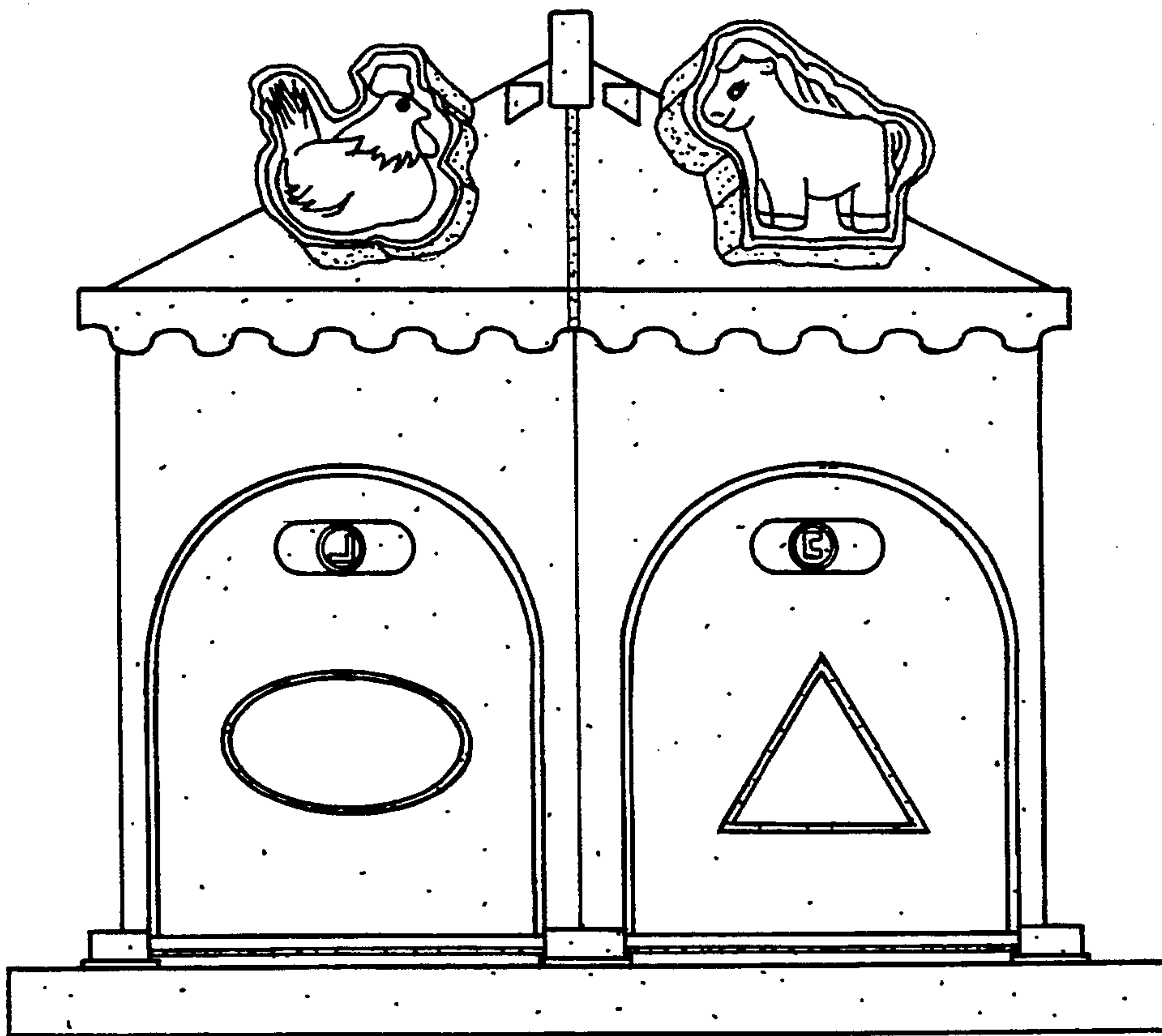

FIG. 5

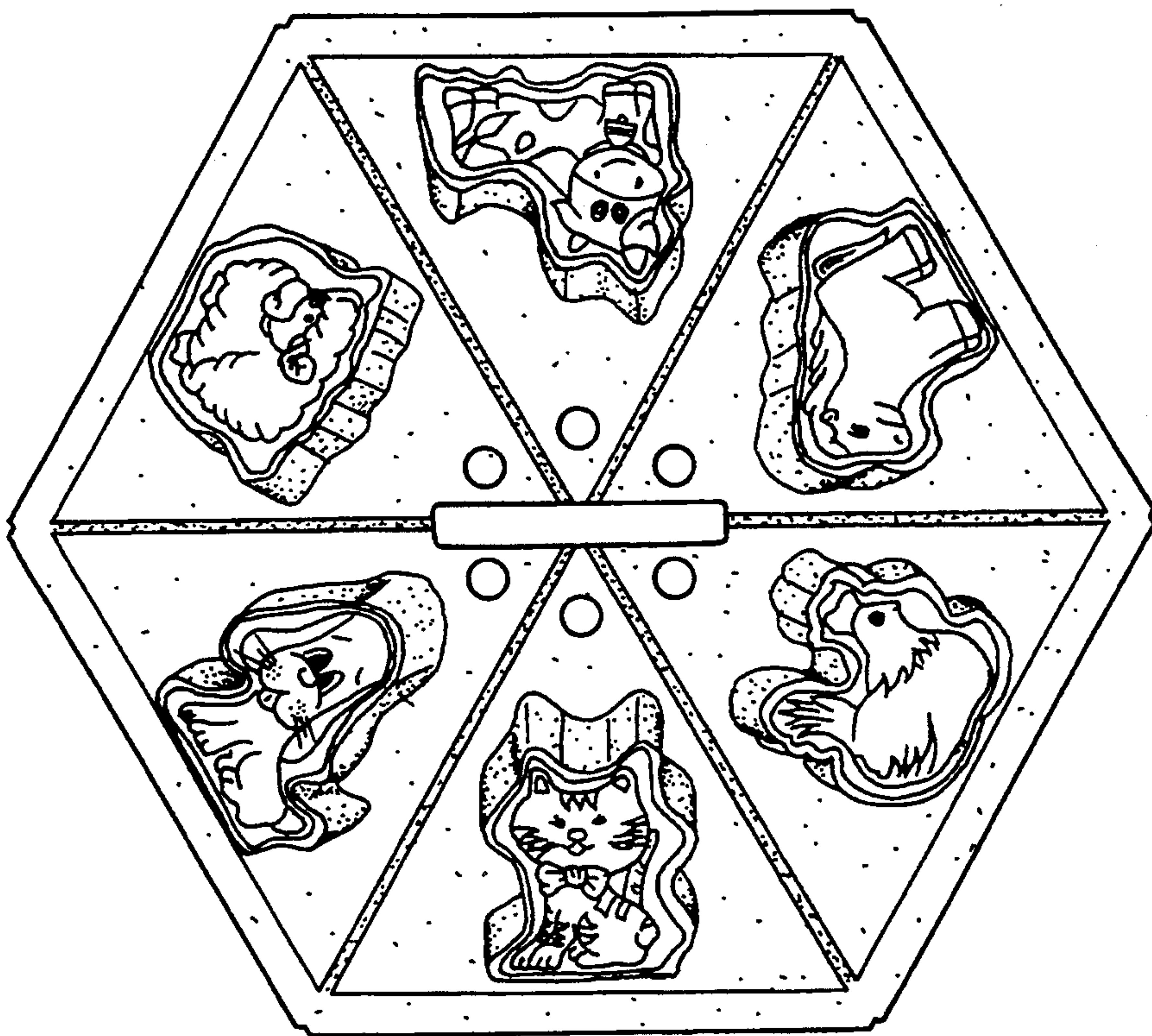

FIG. 6

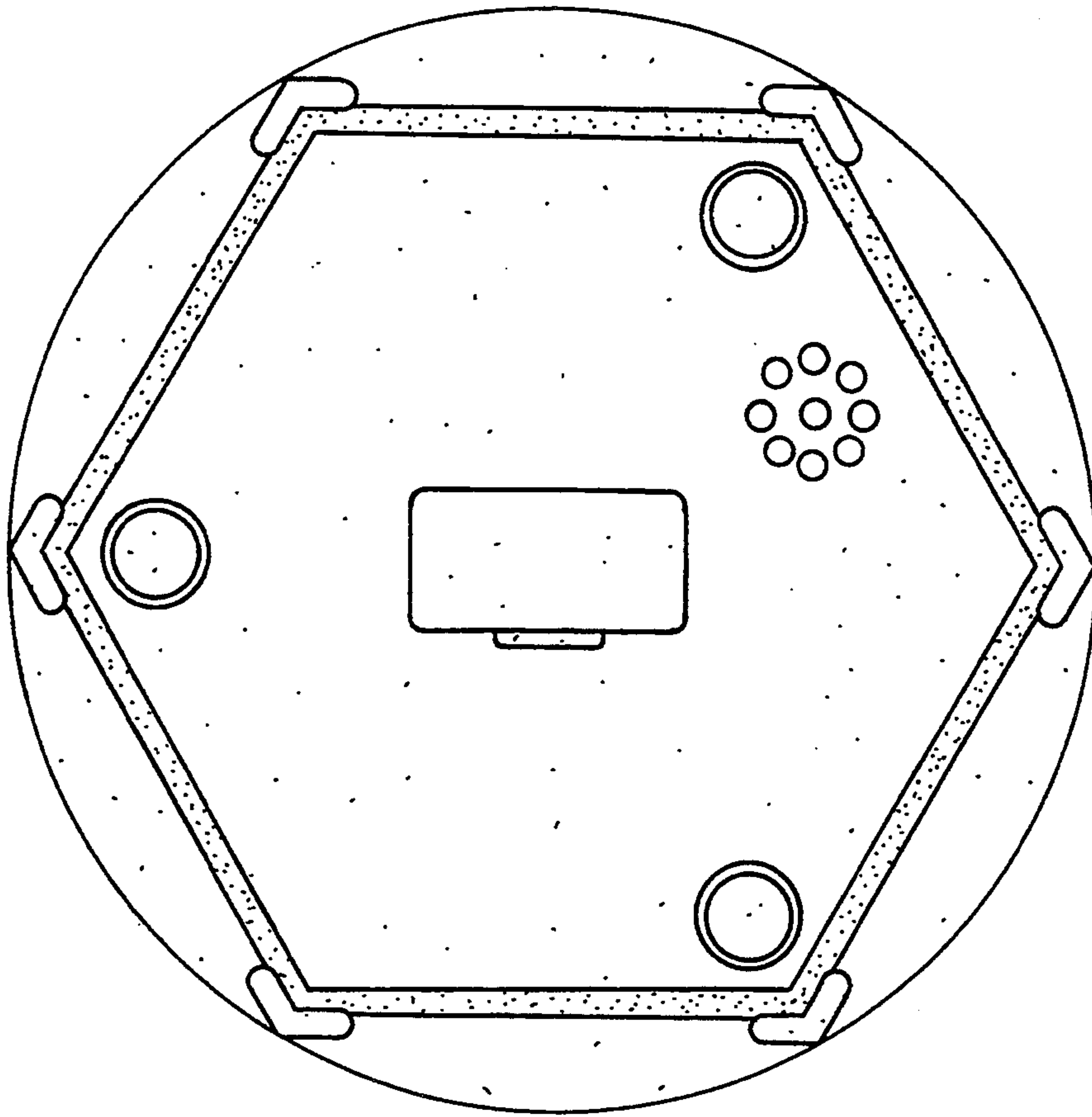

FIG. 7