



US00D353152S

# United States Patent [19]

[11] Patent Number: **Des. 353,152**

Dweck et al.

[45] Date of Patent: **\*\* Dec. 6, 1994**

## [54] WRAP-AROUND EYEGLASSES

[75] Inventors: **Jack Dweck, Scarsdale; Janet A. Ederer, Plainview, both of N.Y.**

[73] Assignee: **Arrow Trading Co. Inc., New York, N.Y.**

[\*\*] Term: **14 Years**

[21] Appl. No.: **5,436**

[22] Filed: **Mar. 4, 1993**

[52] U.S. Cl. .... **D16/312**

[58] Field of Search ..... **351/44, 103; 2/439, 2/447, 452; D16/102, 107, 111, 112, 116, 123, 127**

## [56] References Cited

### U.S. PATENT DOCUMENTS

D. 292,986	12/1987	Magestro	.....	D16/107
D. 311,197	10/1990	Jannard	.....	D16/112
D. 321,702	11/1991	Jennings	.....	D16/107
D. 337,595	7/1993	Reymondet	.....	D16/112
4,955,087	9/1990	Perez	.....	2/452

### OTHER PUBLICATIONS

Surfer Magazine Jun. 1989 p. 71 top of page.

Primary Examiner—Bernard Ansher

Assistant Examiner—R. Barkai

Attorney, Agent, or Firm—Henry R. Lerner

## [57] CLAIM

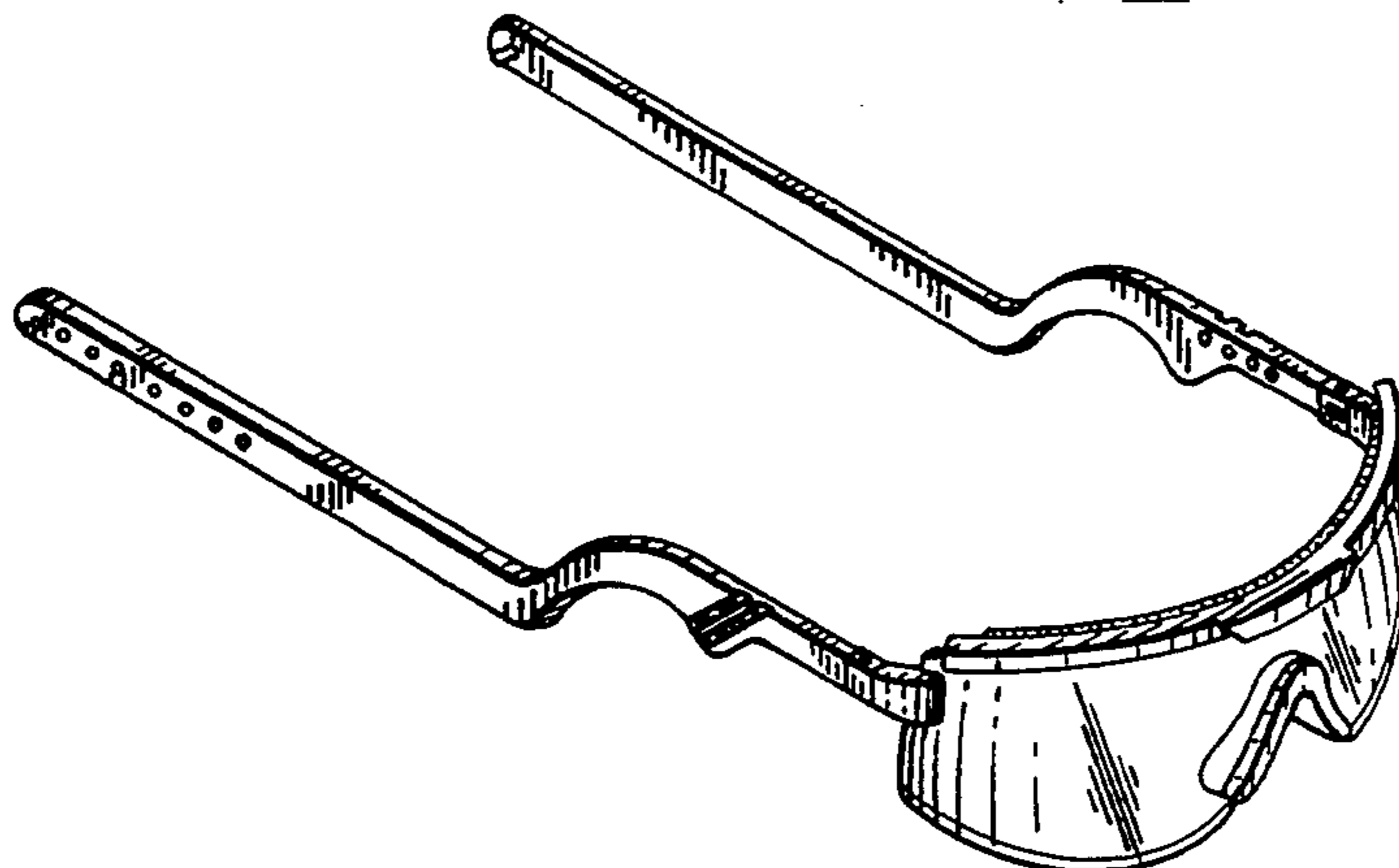
The ornamental designs for wrap-around eyeglasses, as shown and described.

## DESCRIPTION

FIG. 1 is a front perspective view of a wrap-around eyeglasses showing our new design;  
 FIG. 2 is a side elevational view thereof with the free ends of the straps secured;  
 FIG. 3 is a top plan view thereof;  
 FIG. 4 is a front elevational view thereof;  
 FIG. 5 is a rear elevational view thereof;  
 FIG. 6 is a bottom plan view thereof;  
 FIG. 7 is a perspective view of a second modified embodiment of the design shown in FIGS. 1-6 with a hook and loop type fastener on the free ends of the strap;

FIG. 8 is a side elevational view thereof with the free ends of the straps secured;  
 FIG. 9 is a top plan view thereof;  
 FIG. 10 is a front elevational view thereof;  
 FIG. 11 is a rear elevational view thereof;  
 FIG. 12 is a bottom plan view thereof;  
 FIG. 13 is a perspective view of a third modified embodiment of the design shown in FIGS. 1-6 with a buckle at the free end of the strap;  
 FIG. 14 is a side elevational view thereof with the free ends of the straps secured;  
 FIG. 15 is a top plan view thereof;  
 FIG. 16 is a front elevational view thereof;  
 FIG. 17 is a rear elevational view thereof;  
 FIG. 18 is a bottom plan view thereof;  
 FIG. 19 is a perspective view of a fourth modified embodiment of the design shown in FIGS. 1-6 with sides that are not adjustable;  
 FIG. 20 is a side elevational view thereof with the free ends of the straps secured;  
 FIG. 21 is a top plan view thereof;  
 FIG. 22 is a front elevational view thereof;  
 FIG. 23 is a rear elevational view thereof;  
 FIG. 24 is a bottom plan view thereof;  
 FIG. 25 is a perspective view of a fifth modified embodiment of the design shown in FIGS. 1-6 with a hook and loop type fastener on the free ends of the strap and the sides are not adjustable;  
 FIG. 26 is a side elevational view thereof with the free ends of the straps secured;  
 FIG. 27 is a top plan view thereof;  
 FIG. 28 is a front elevational view thereof;  
 FIG. 29 is a rear elevational view thereof;  
 FIG. 30 is a bottom plan view thereof;  
 FIG. 31 is a perspective view of a sixth modified embodiment of the design shown in FIGS. 1-6 with a buckle on the free end and the sides are not adjustable;  
 FIG. 32 is a side elevational view thereof with the free ends of the straps secured;  
 FIG. 33 is a top plan view thereof;  
 FIG. 34 is a front elevational view thereof;  
 FIG. 35 is a rear elevational view thereof;  
 FIG. 36 is a bottom plan view thereof;  
 FIG. 37 is a perspective view of a seventh modified embodiment of the design shown in FIGS. 1-6 with an elastic accordion type strap;

(Description continued on next page.)



## Des. 353,152

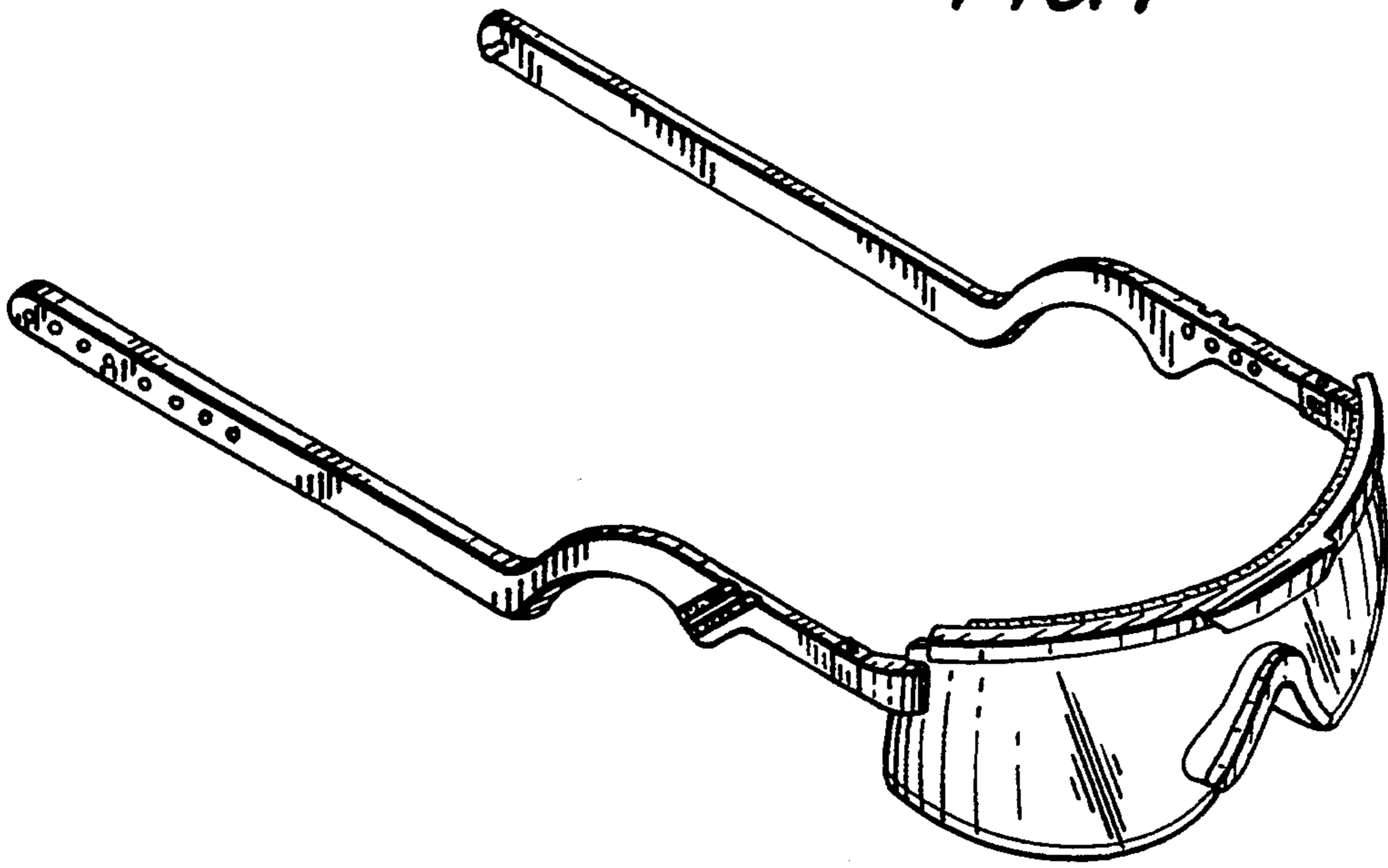
Page 2

---

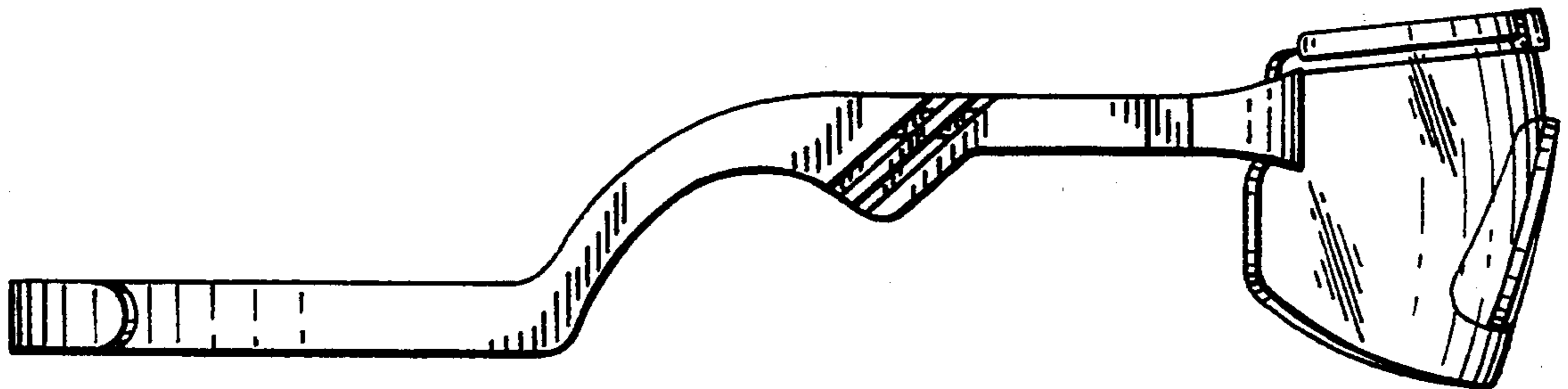
FIG. 38 is a side elevational view thereof;  
FIG. 39 is a top plan view thereof;  
FIG. 40 is a front elevational view thereof;  
FIG. 41 is a rear elevational view thereof;  
FIG. 42 is a bottom plan view thereof;  
FIG. 43 is a perspective view of a eighth modified em-

bodiment of the design shown in FIGS. 1-6 an elastic accordion type strap and the sides are not adjustable;  
FIG. 44 is a side elevational view thereof;  
FIG. 45 is a top plan view thereof;  
FIG. 46 is a front elevational view thereof;  
FIG. 47 is a rear elevational view thereof; and,  
FIG. 48 is a bottom plan view thereof.

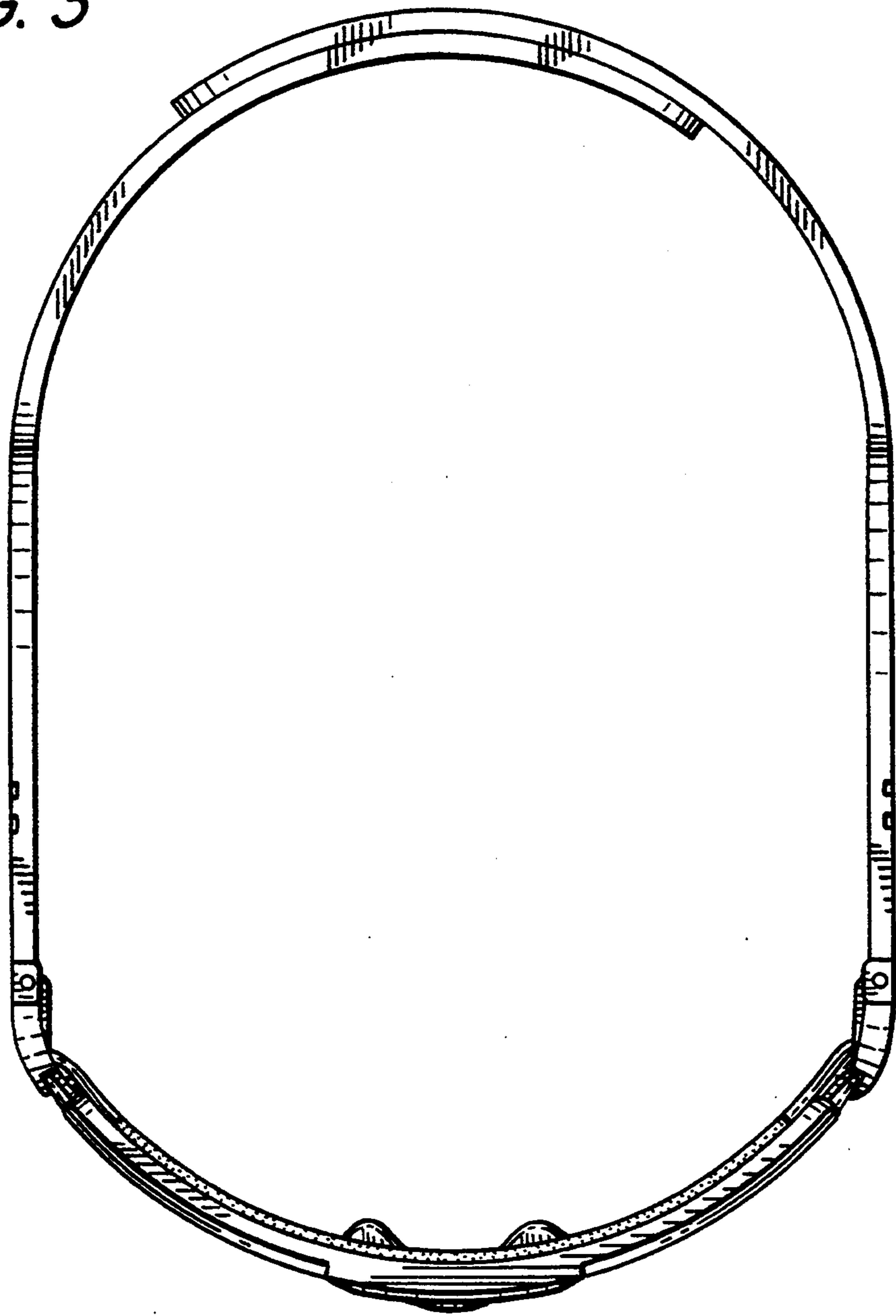
*FIG. 1*



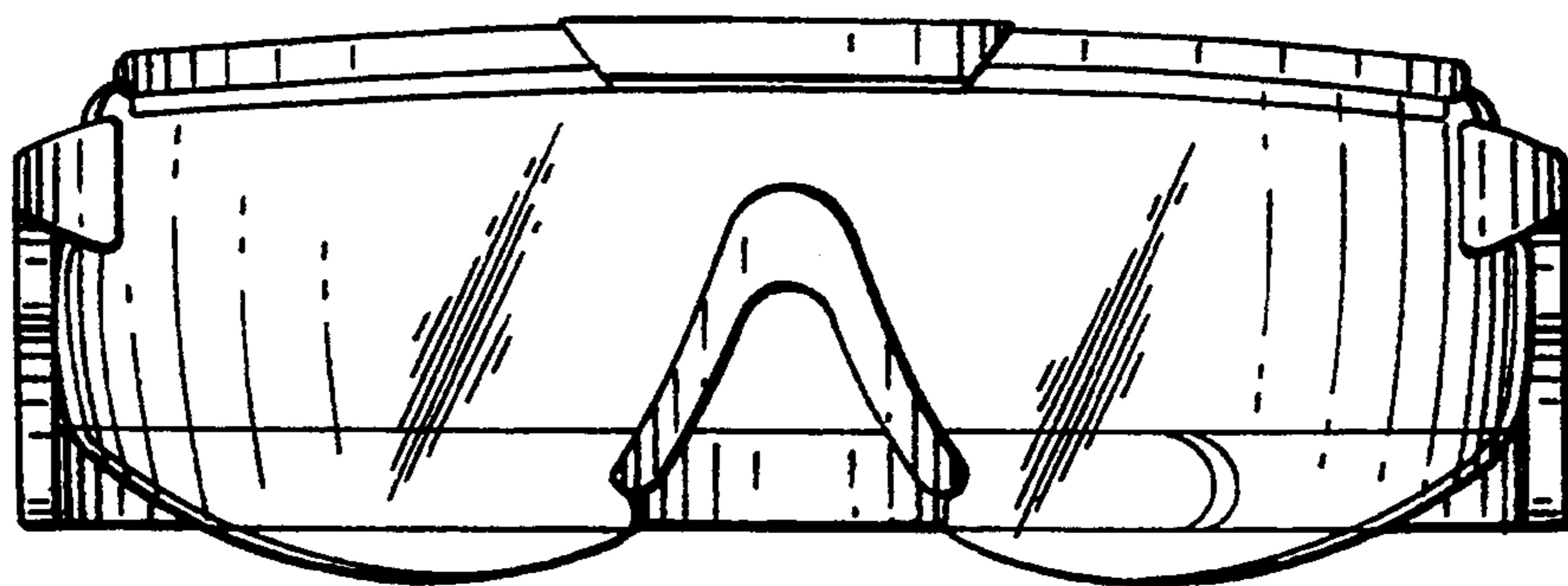
*FIG. 2*



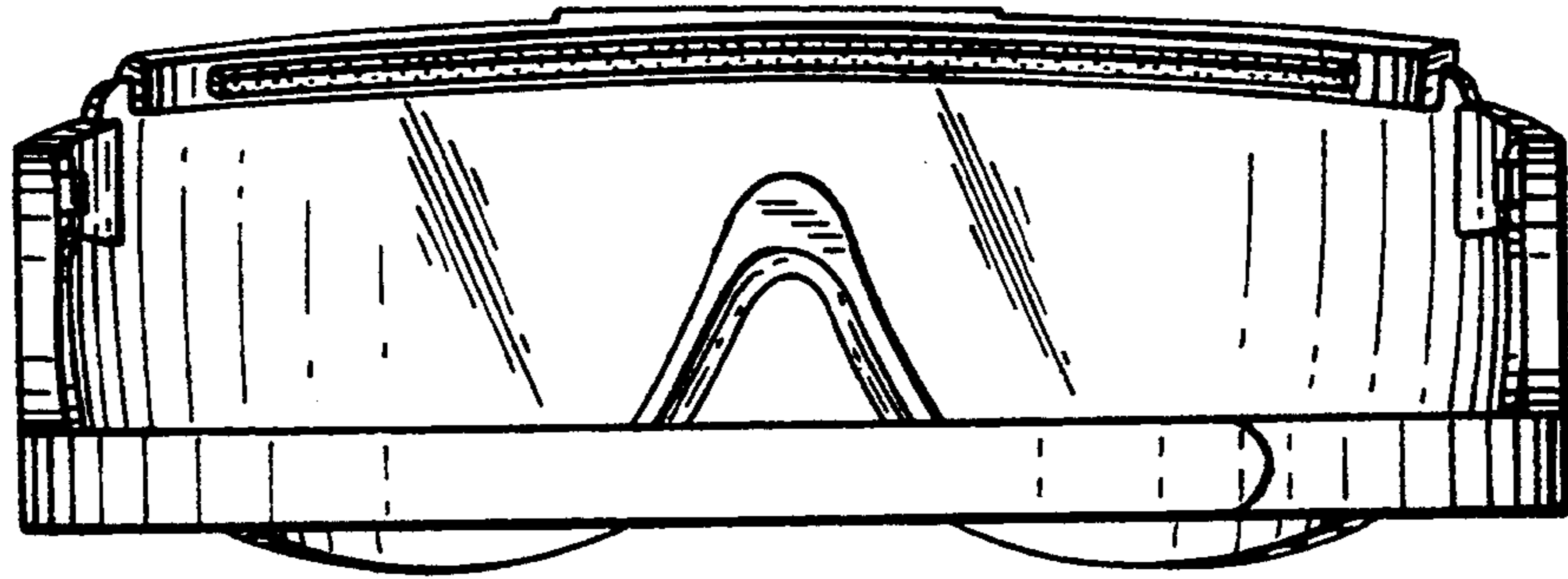
*FIG. 3*



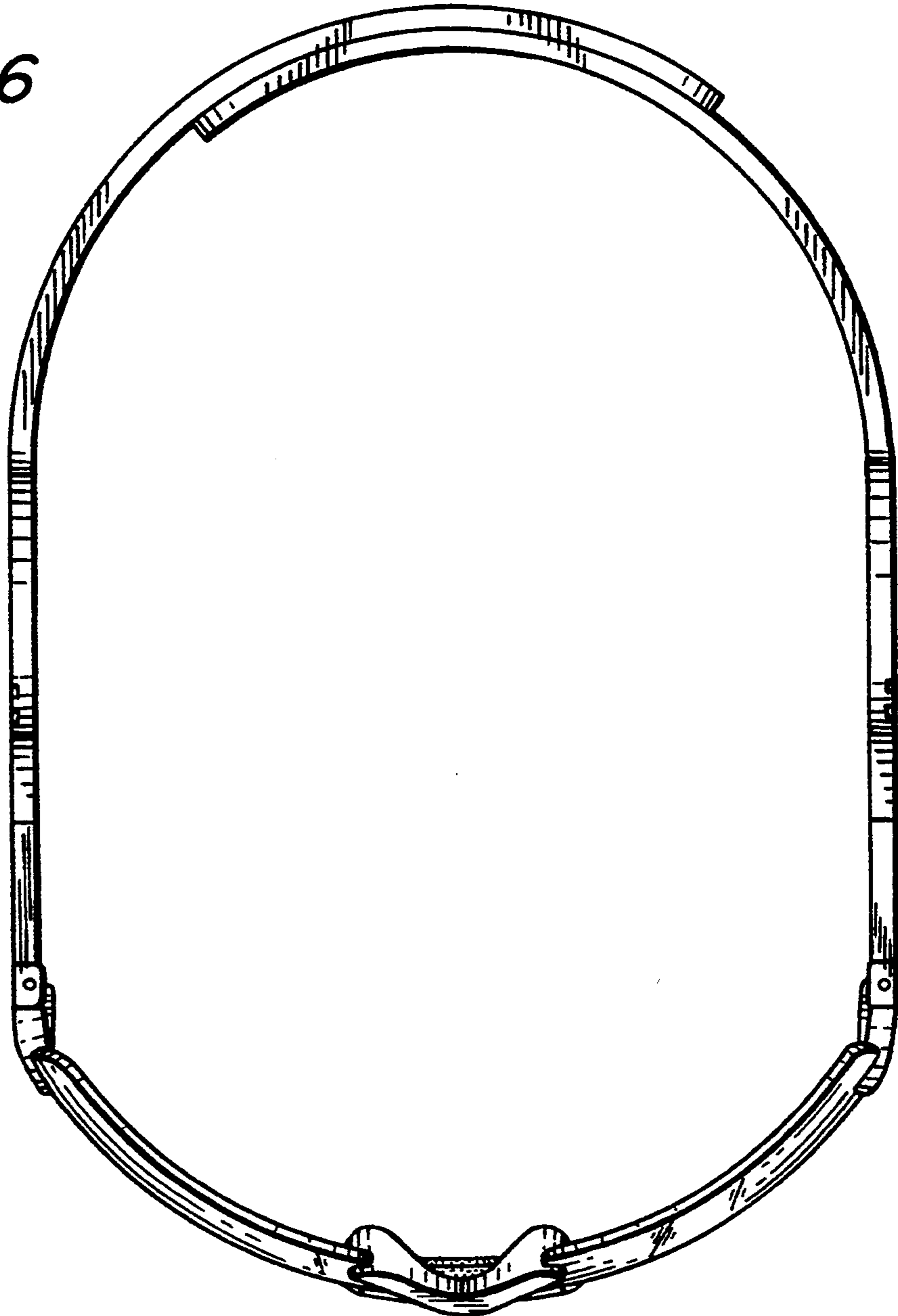
*FIG. 4*



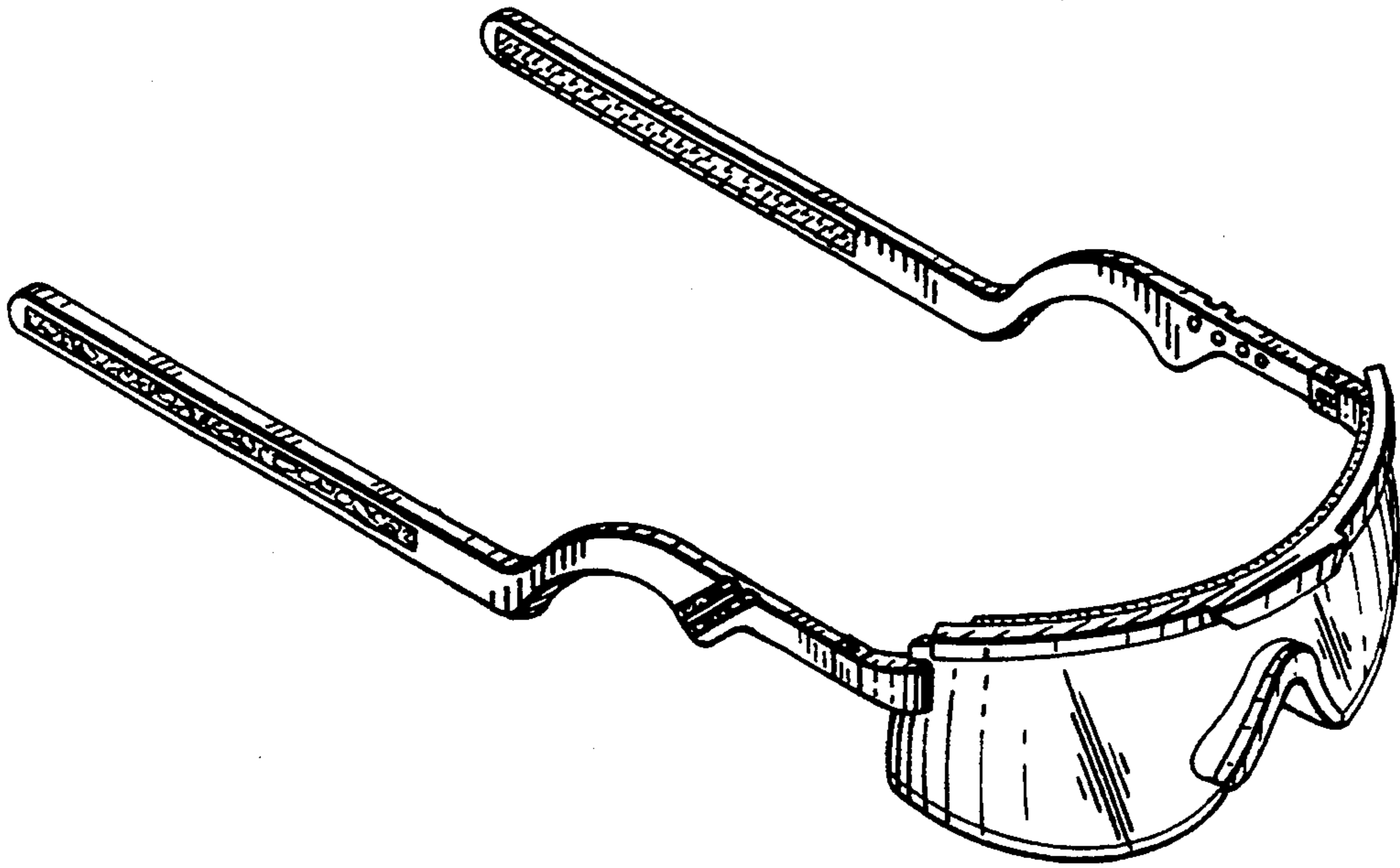
*FIG. 5*



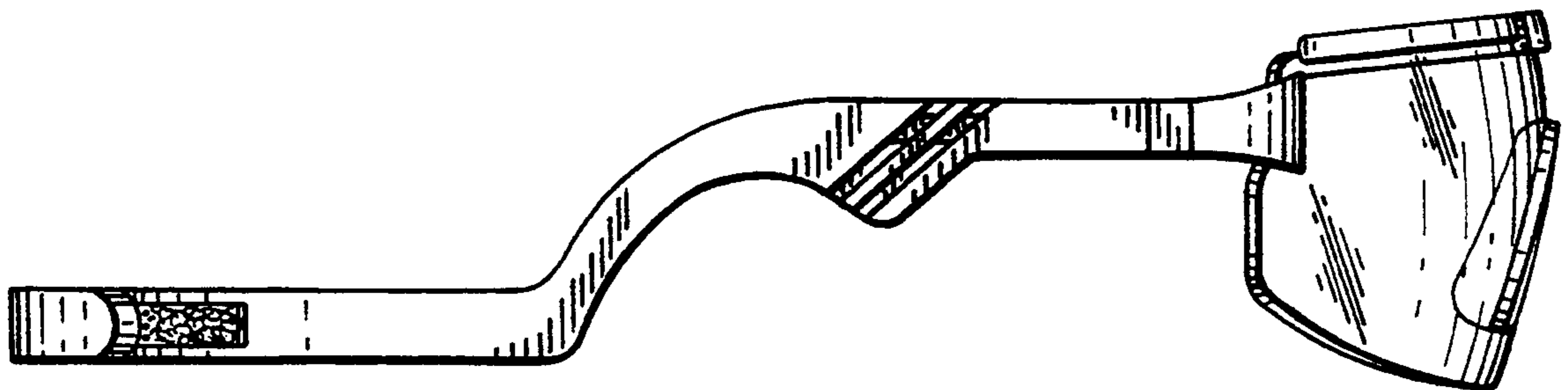
*FIG. 6*



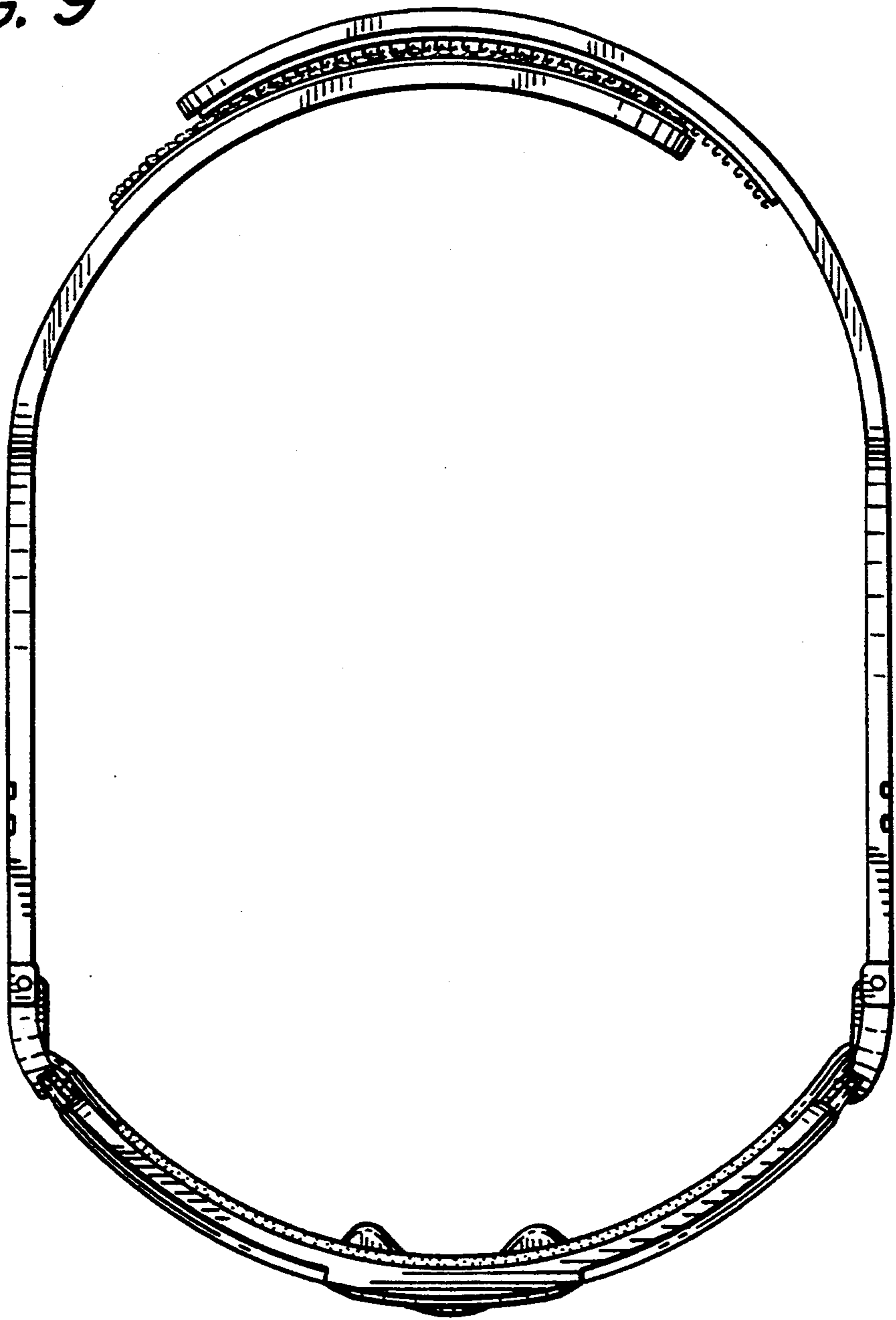
*FIG. 7*



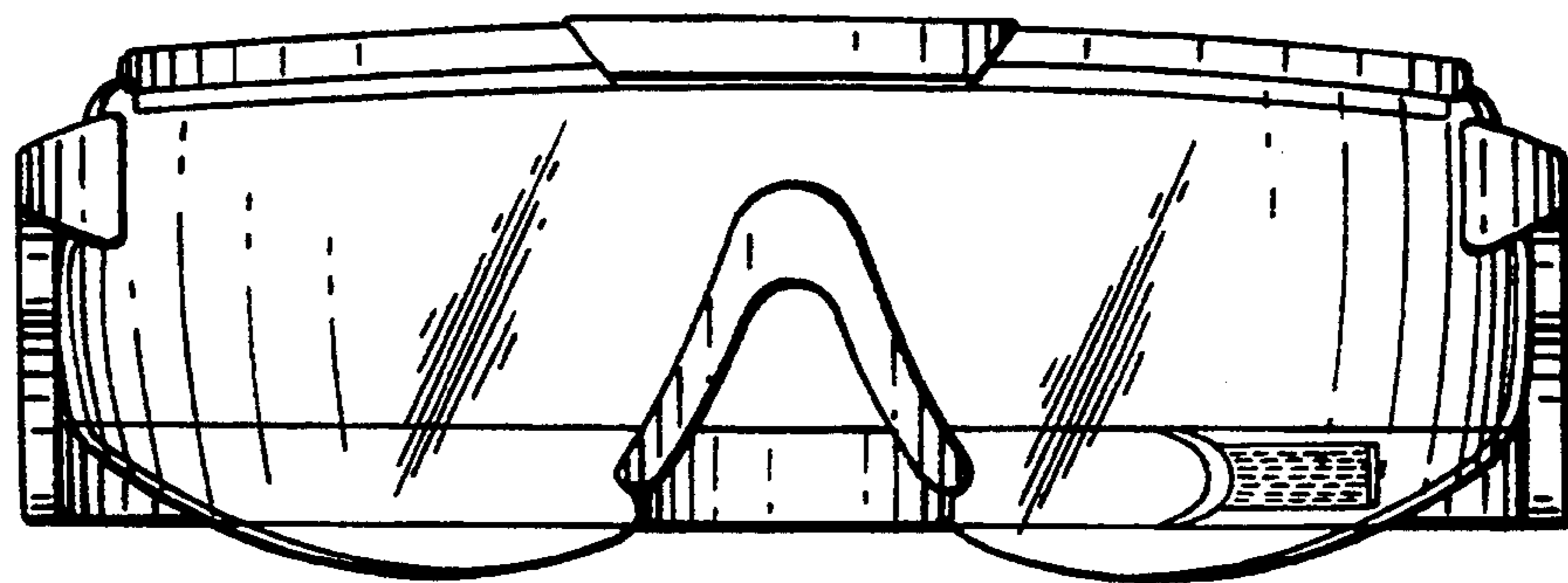
*FIG. 8*



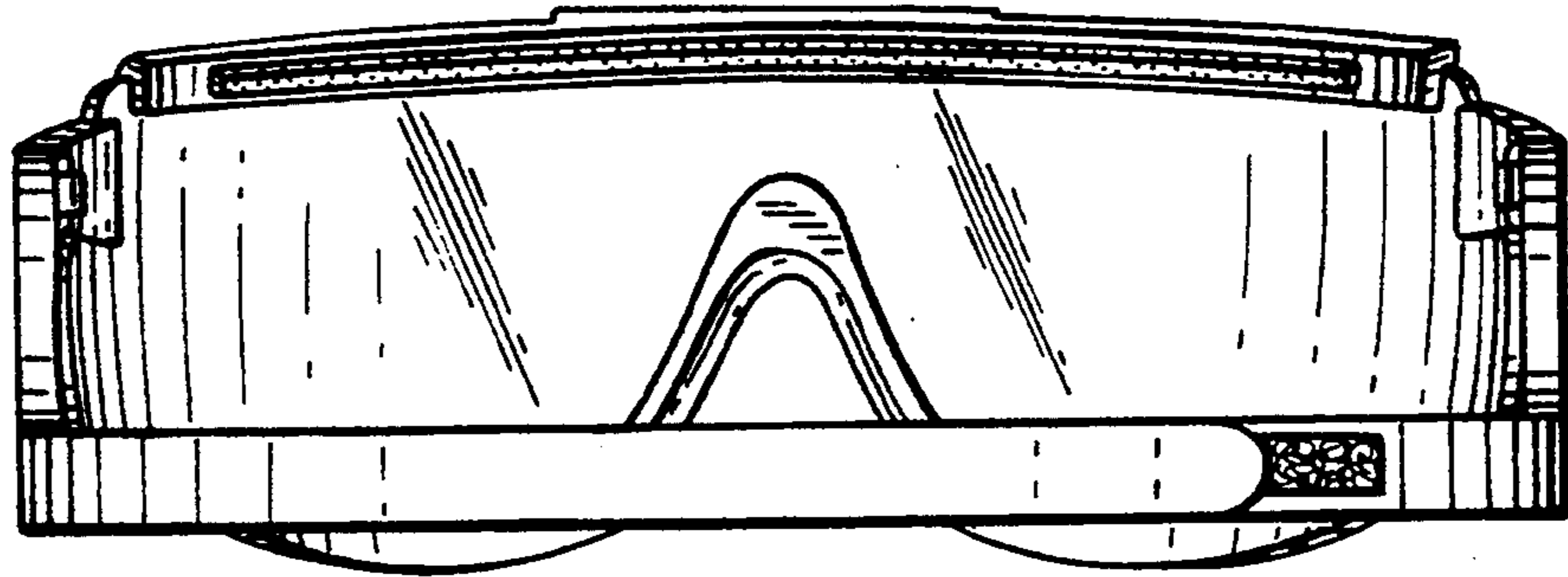
*FIG. 9*



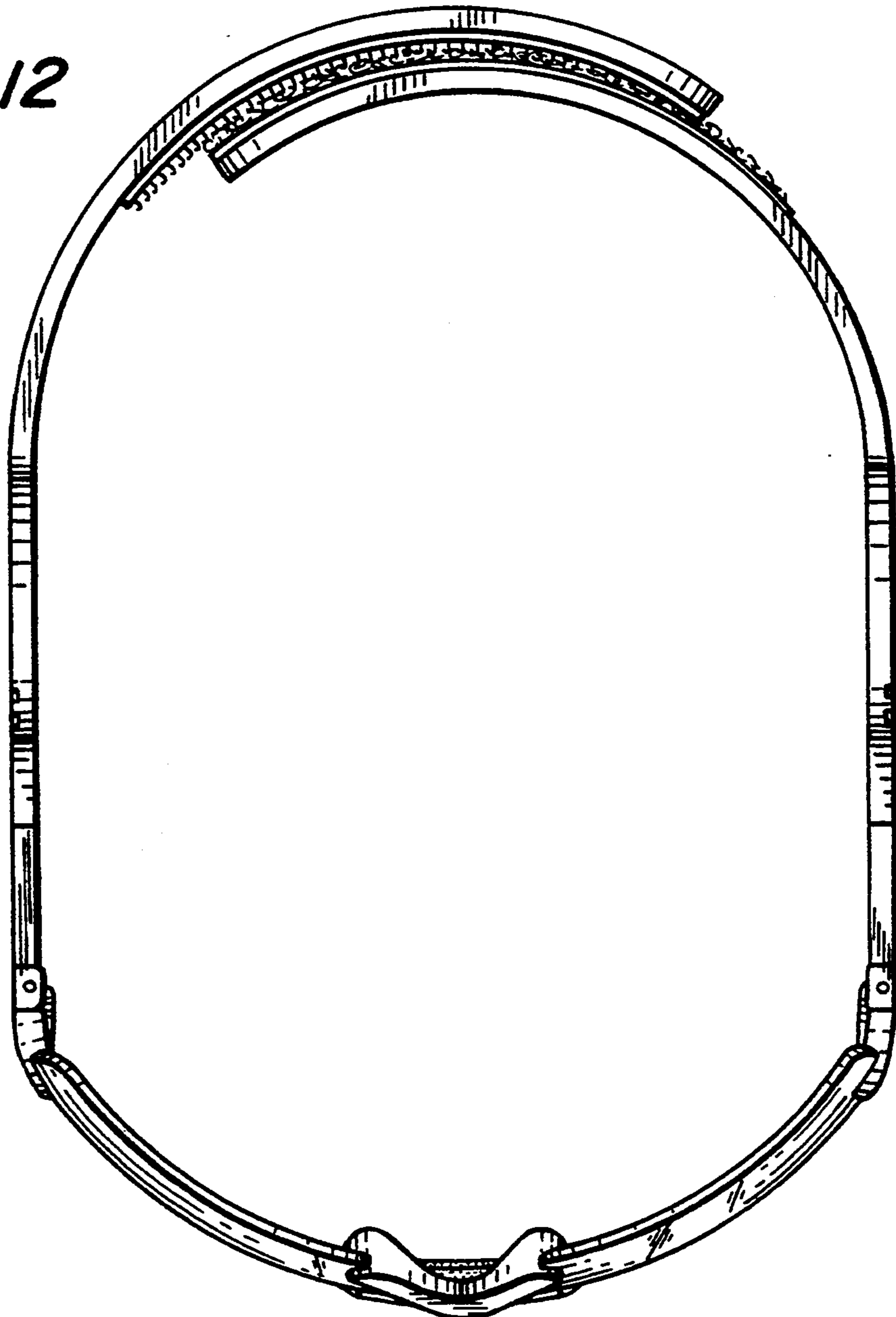
*FIG. 10*



*FIG. 11*

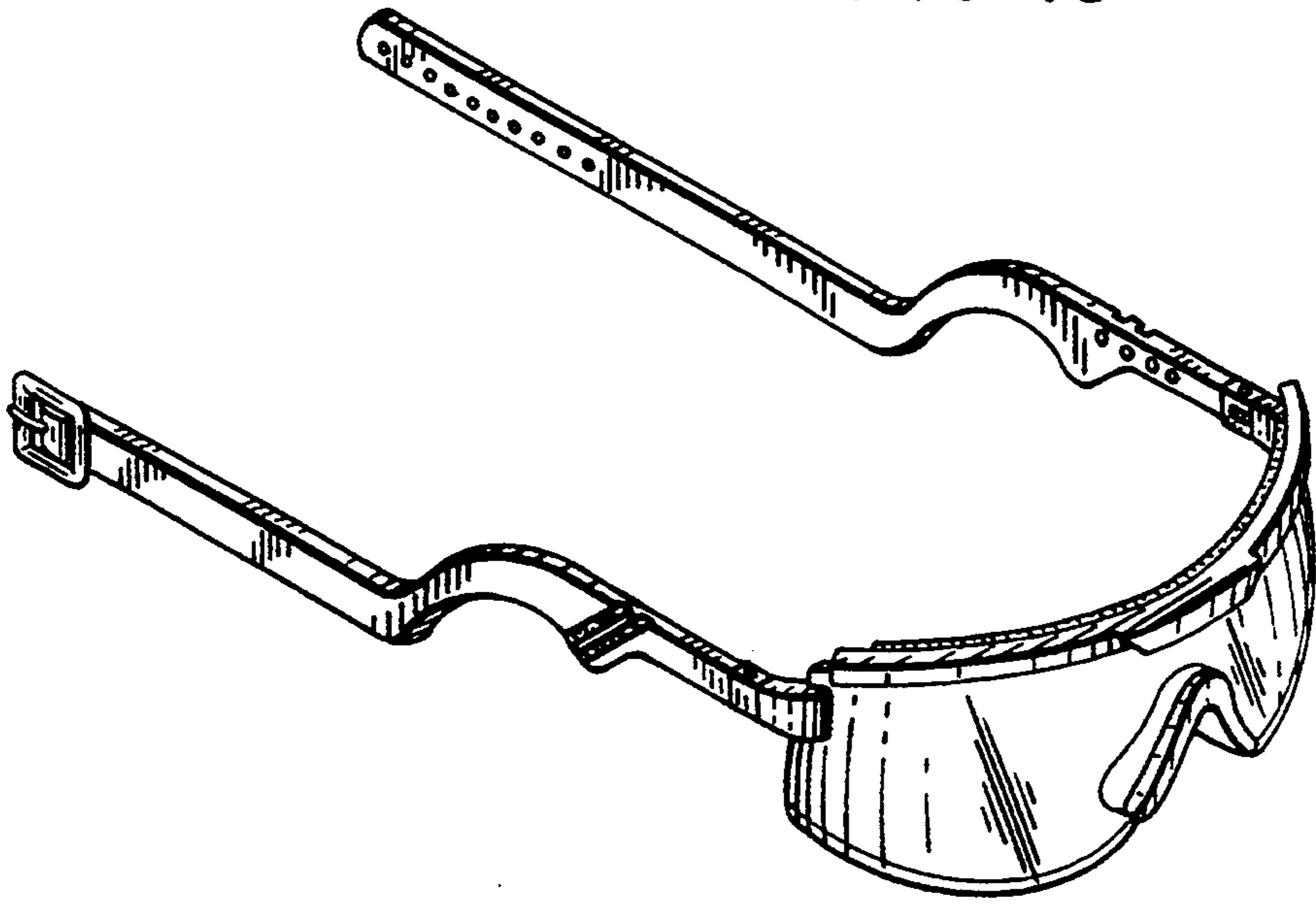


*FIG. 12*

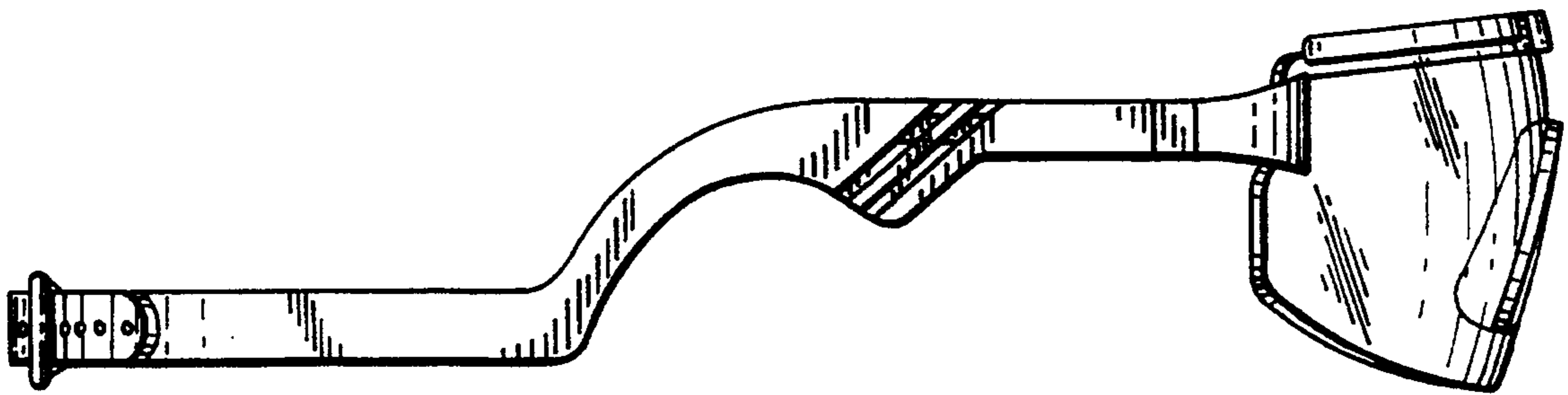




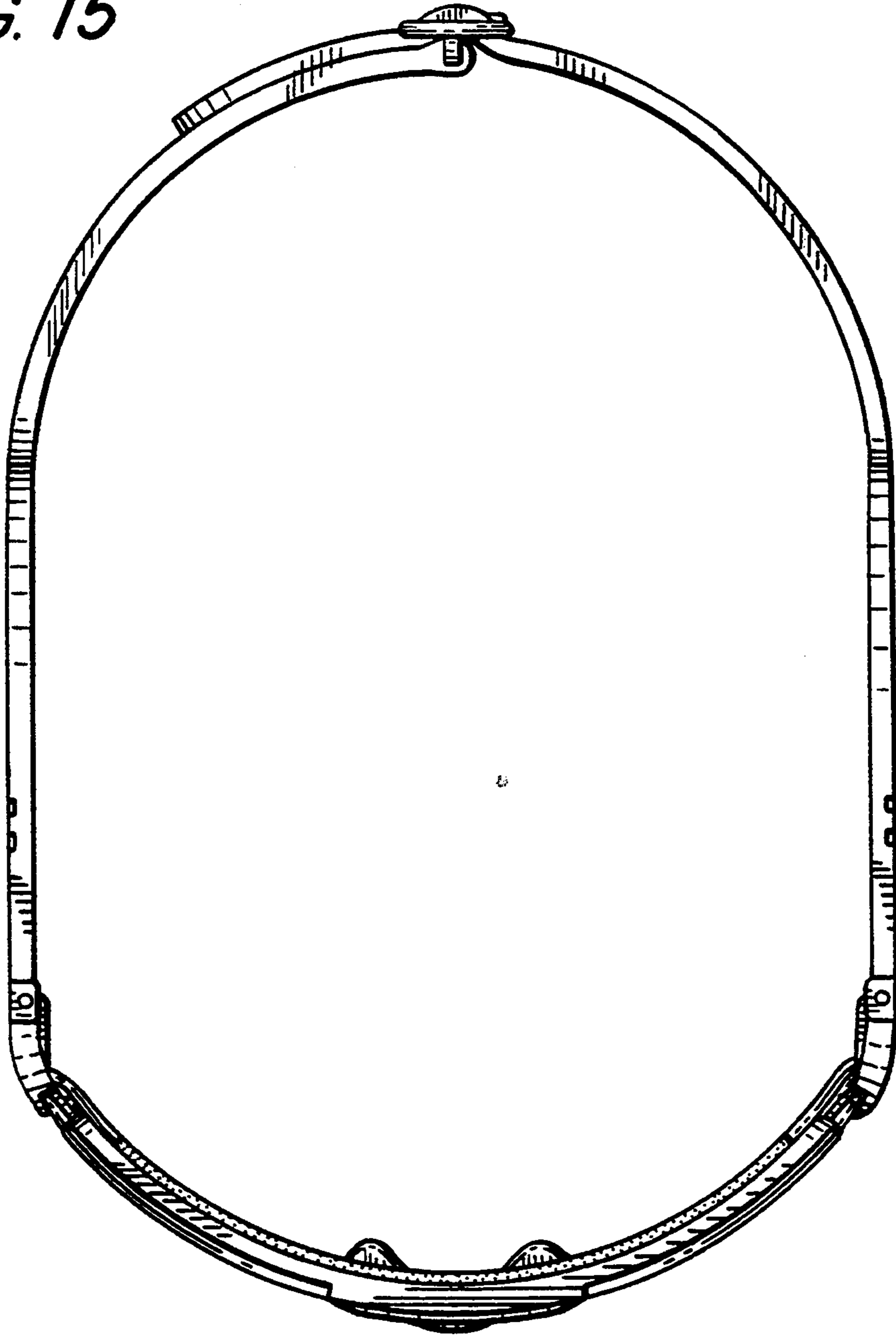
*FIG. 13*



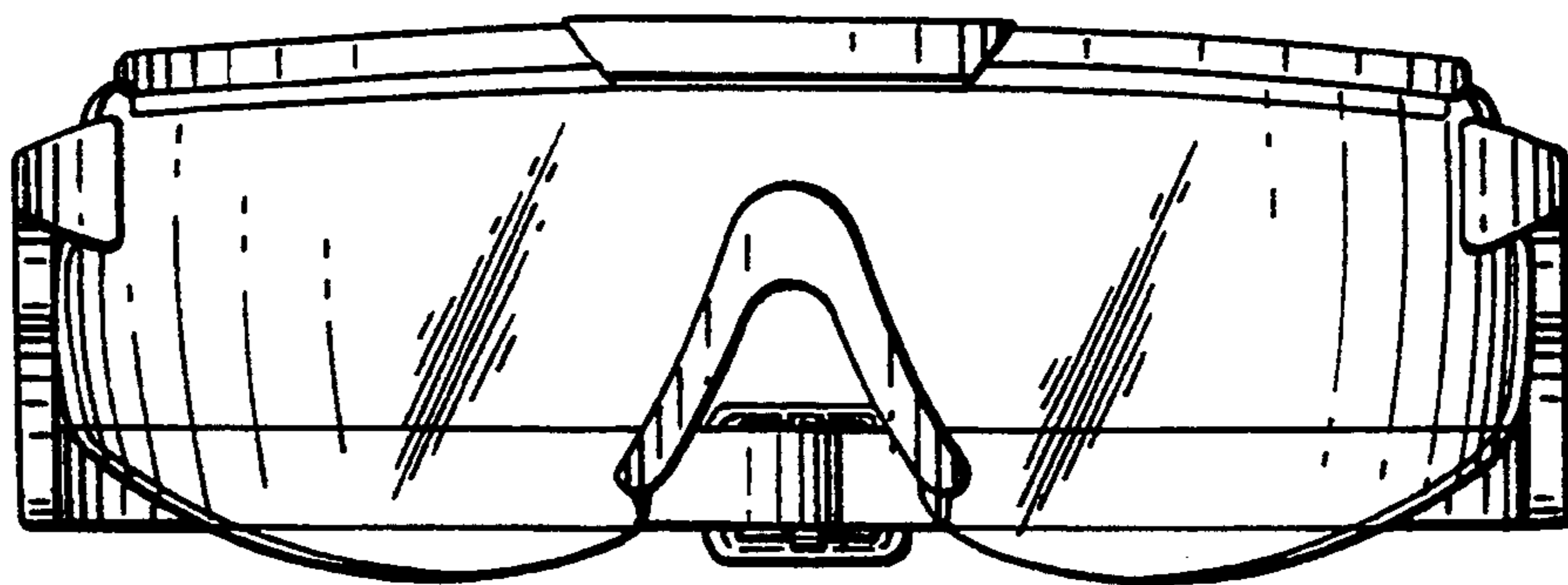
*FIG. 14*



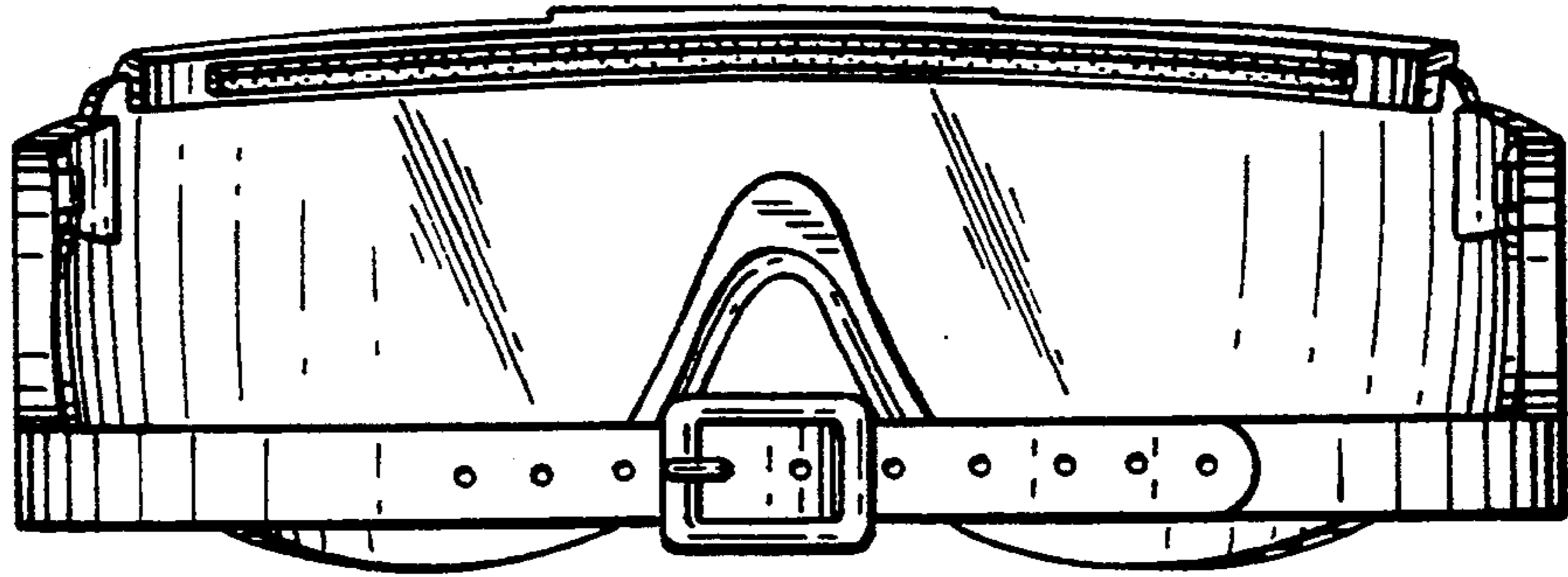
*FIG. 15*



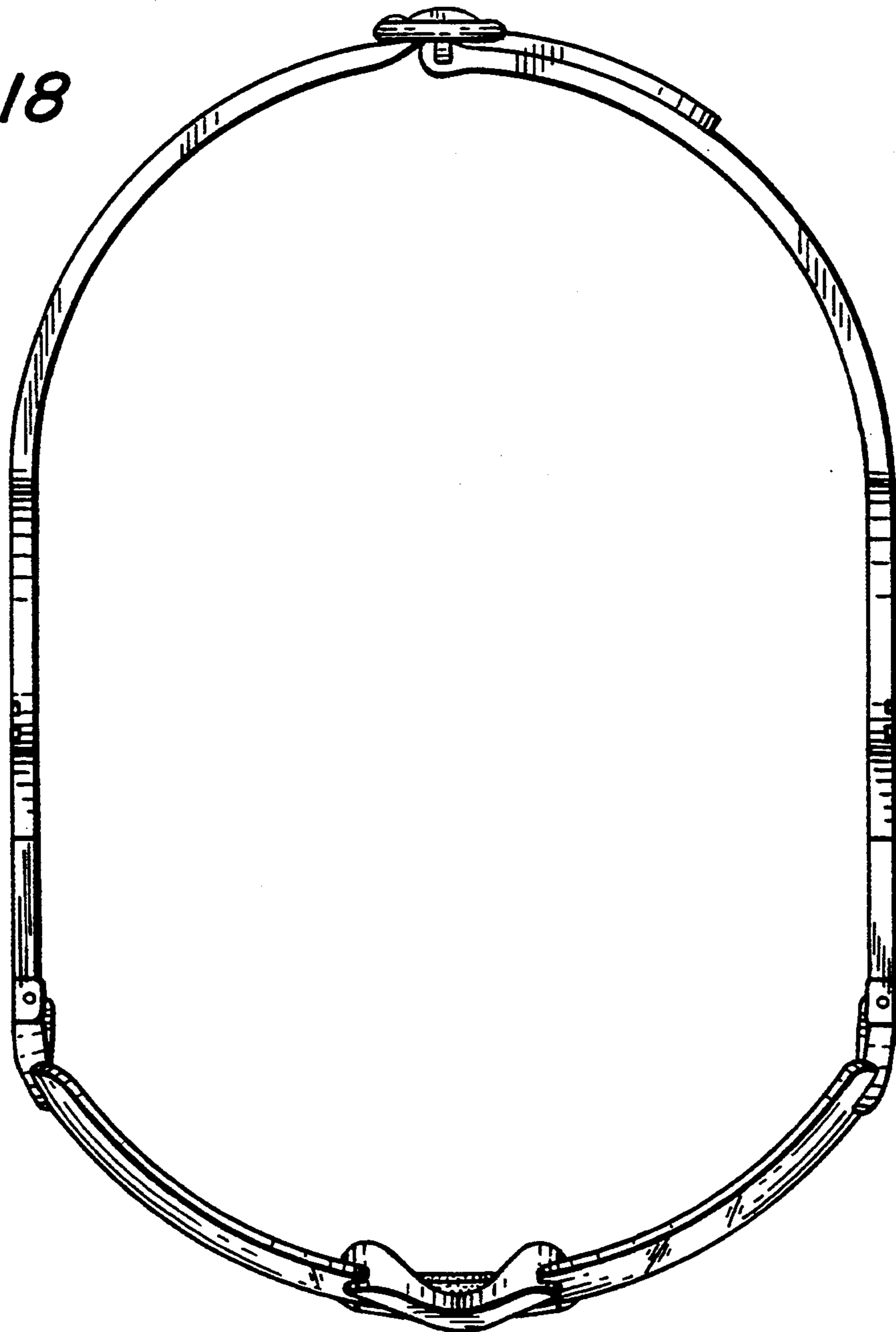
*FIG. 16*



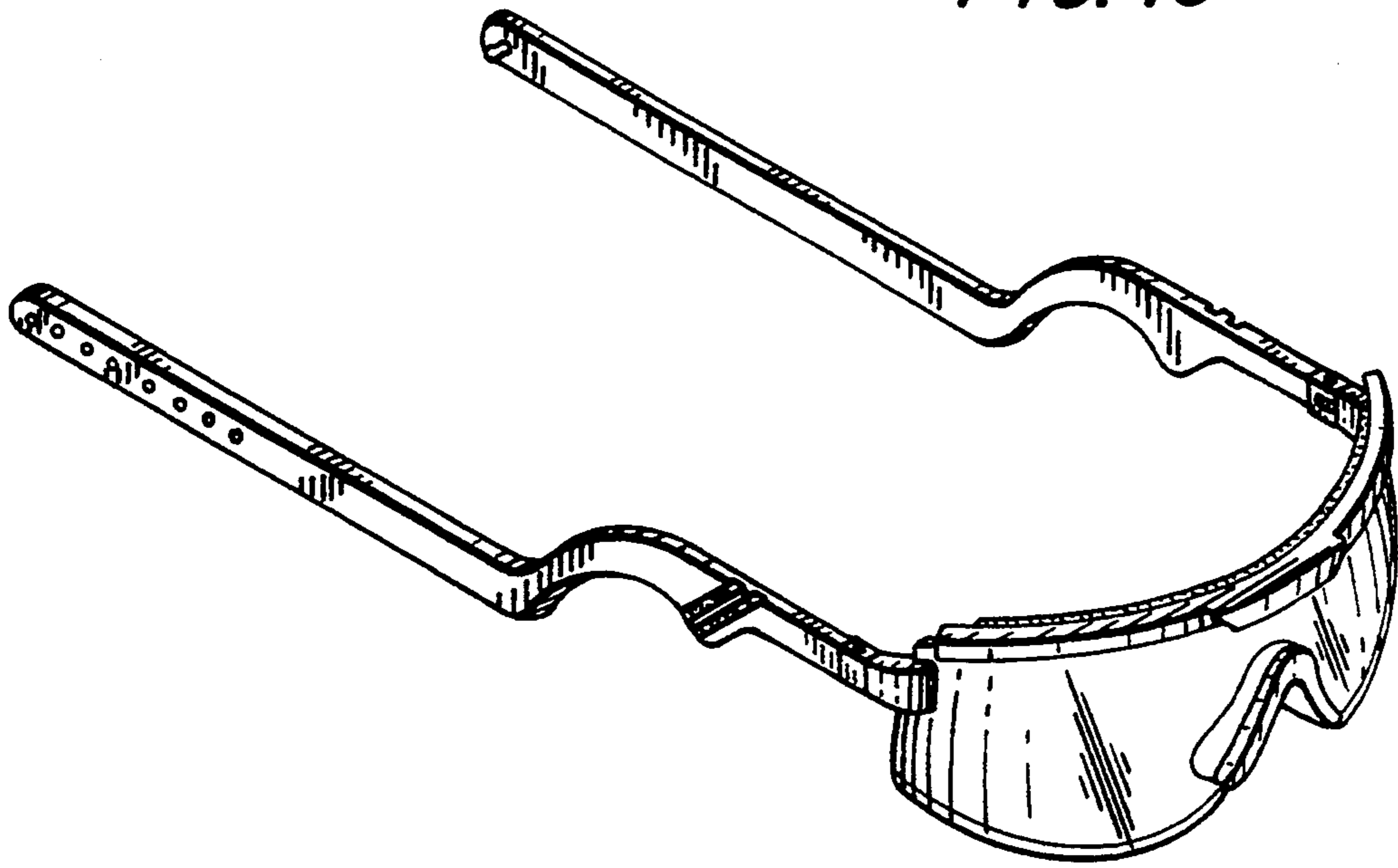
*FIG. 17*



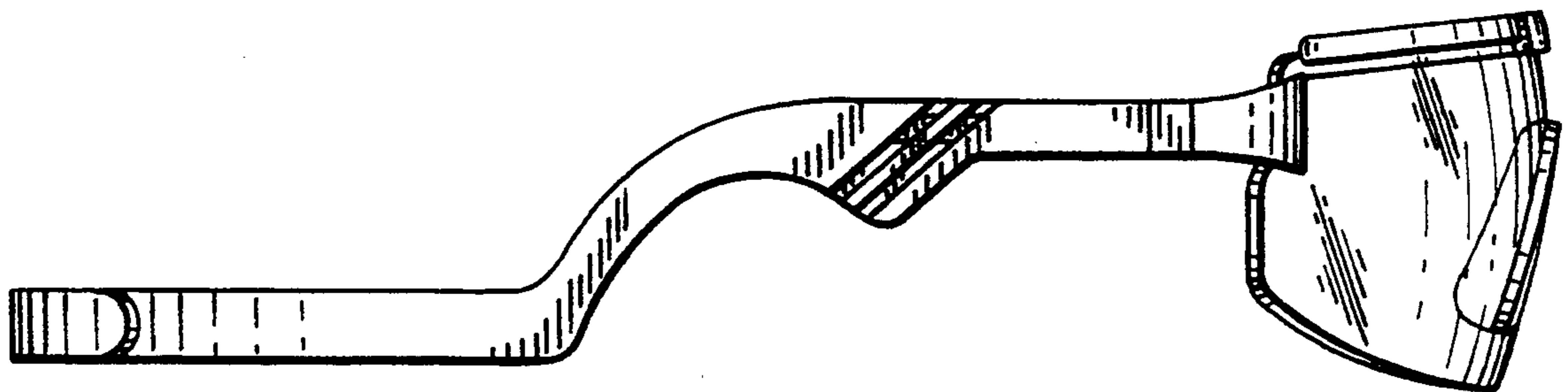
*FIG. 18*



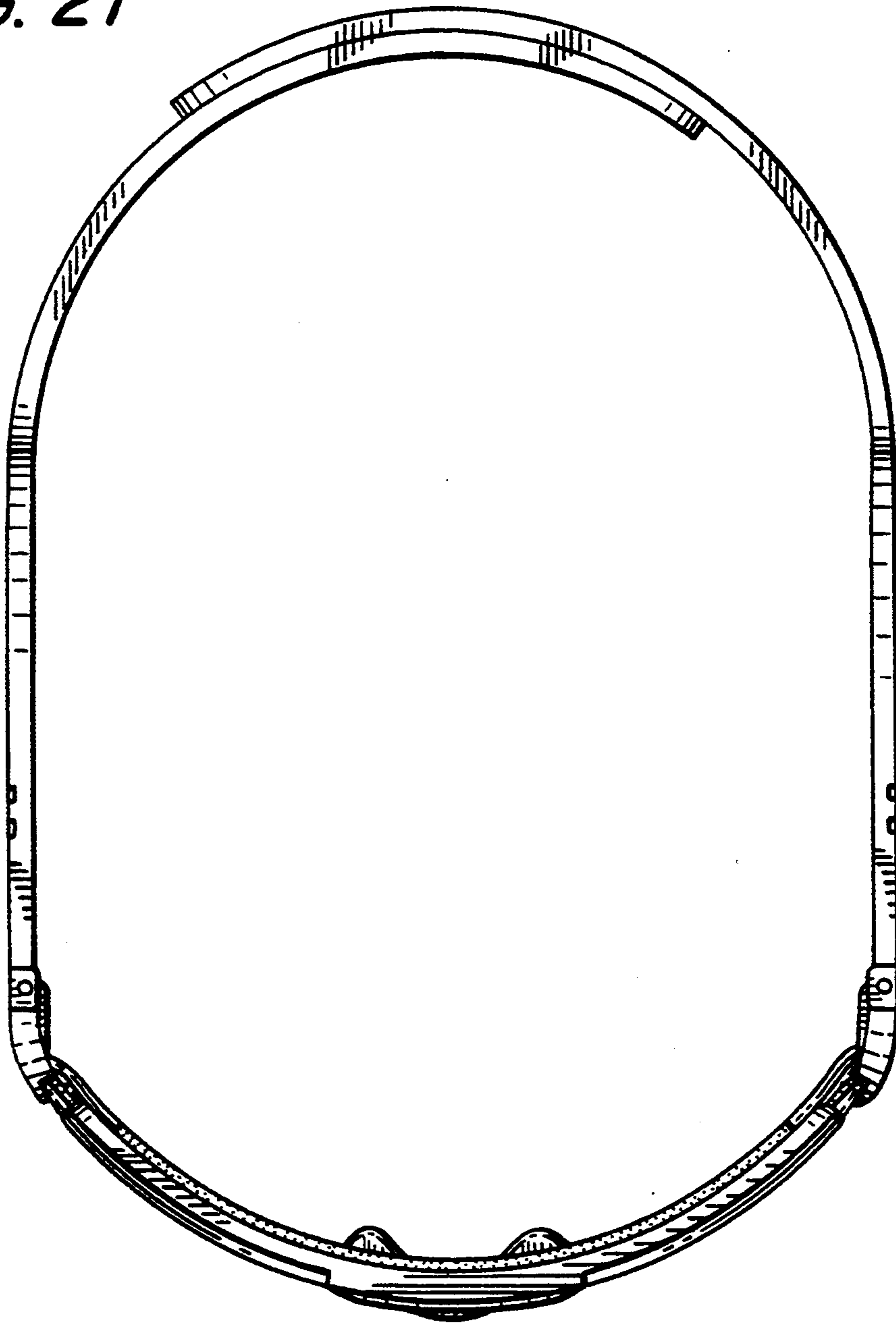
*FIG. 19*



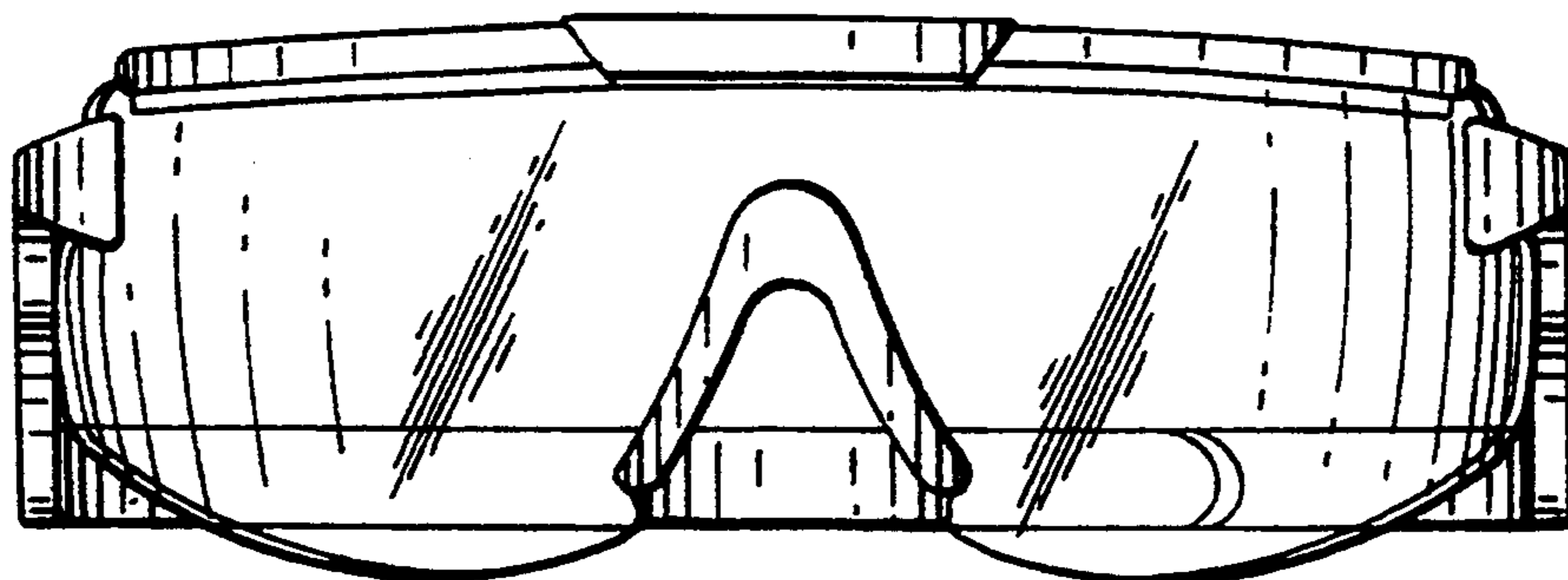
*FIG. 20*



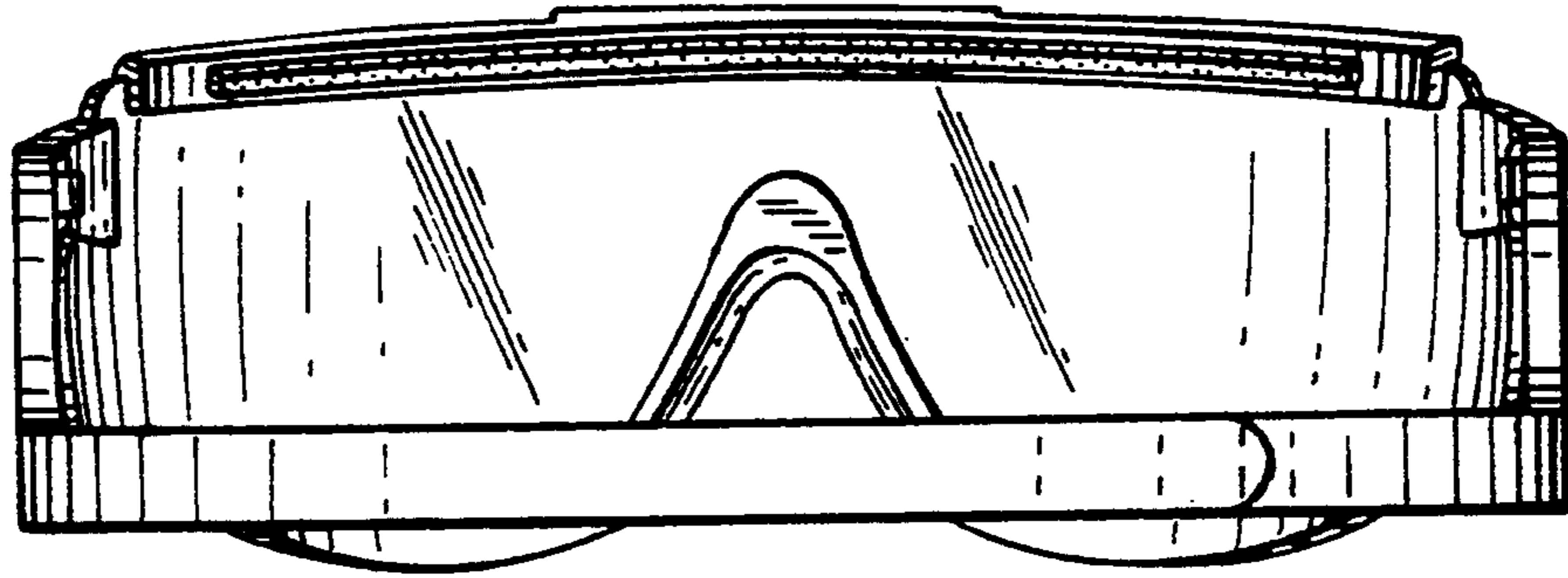
*FIG. 21*



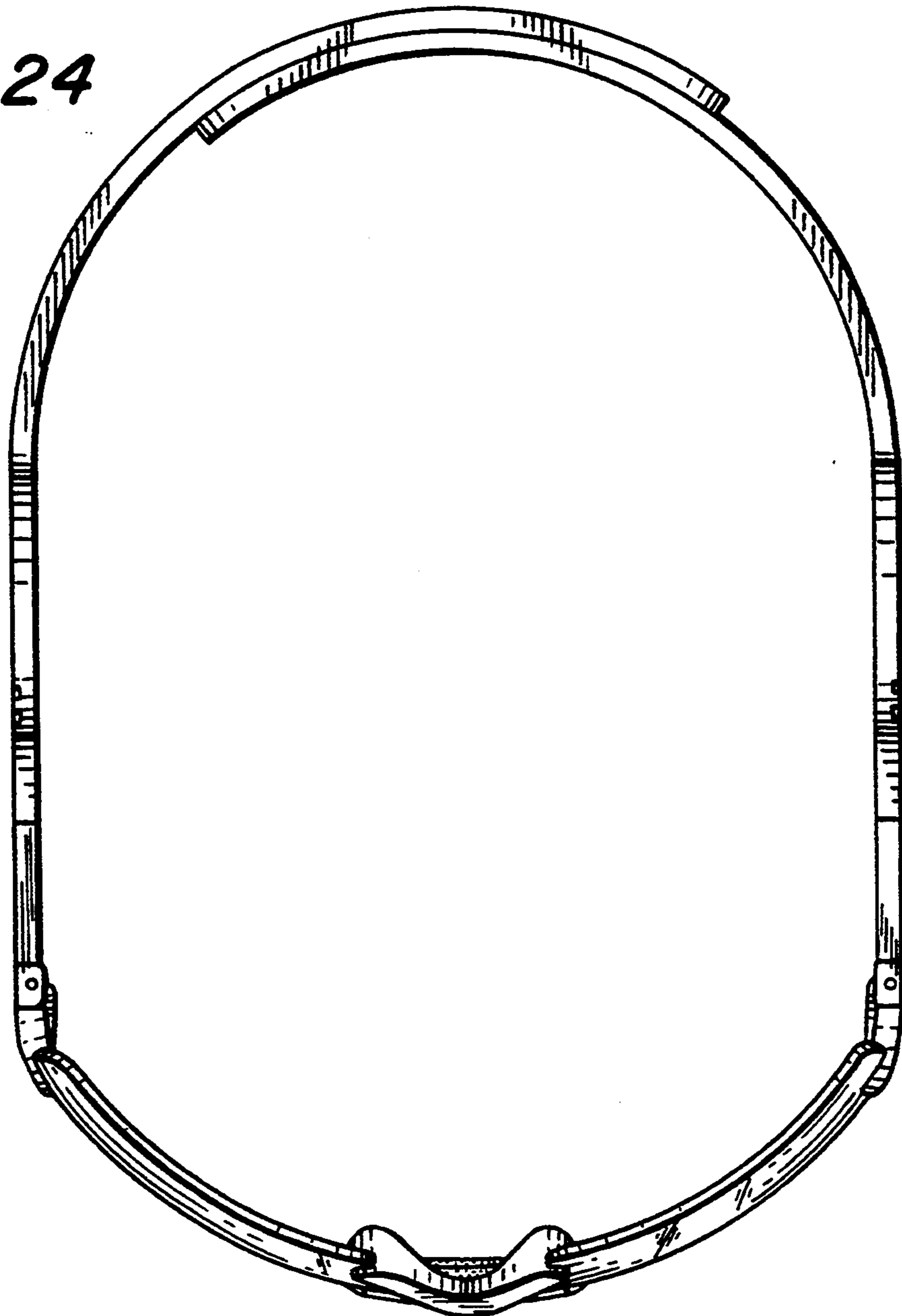
*FIG. 22*



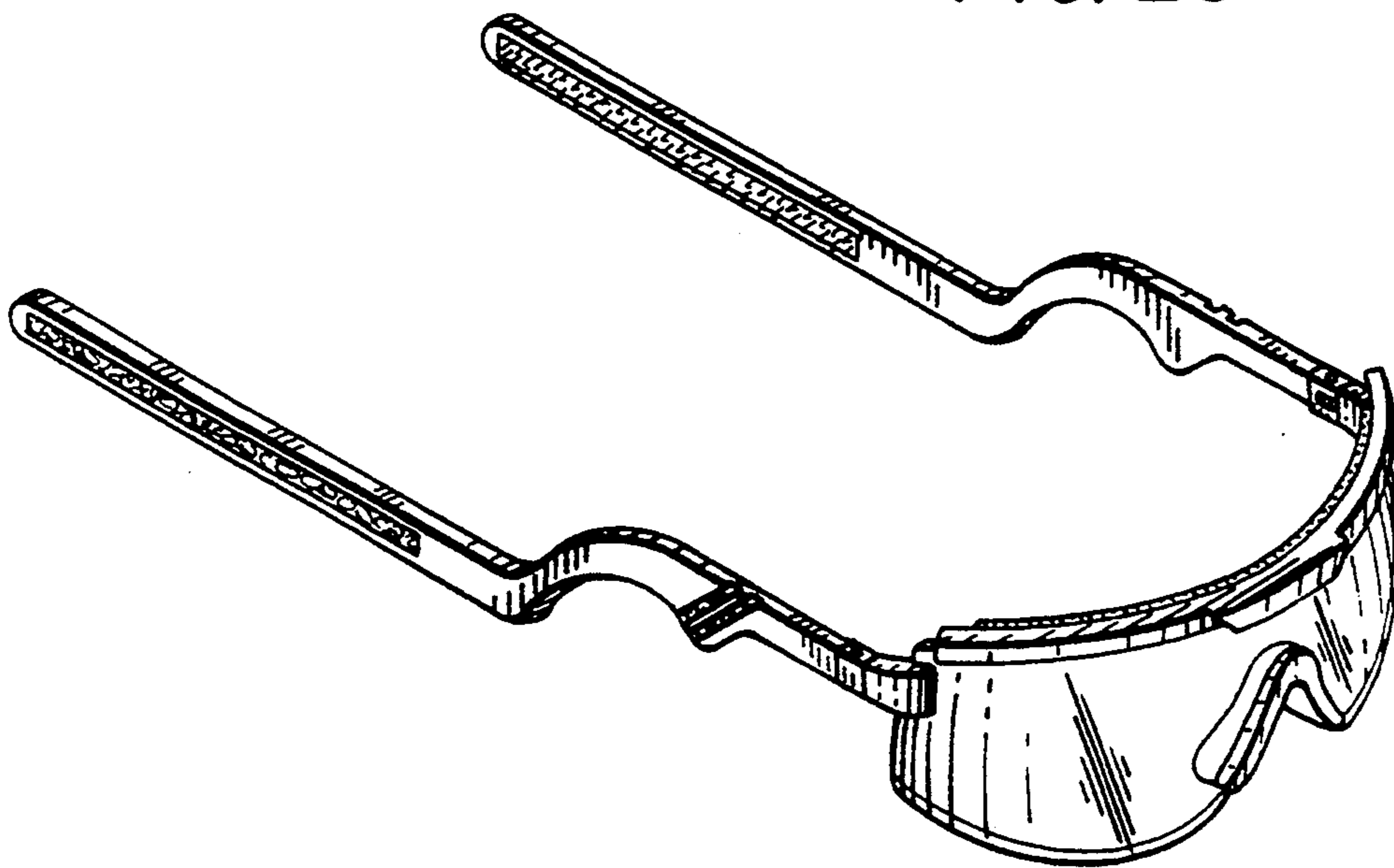
*FIG. 23*



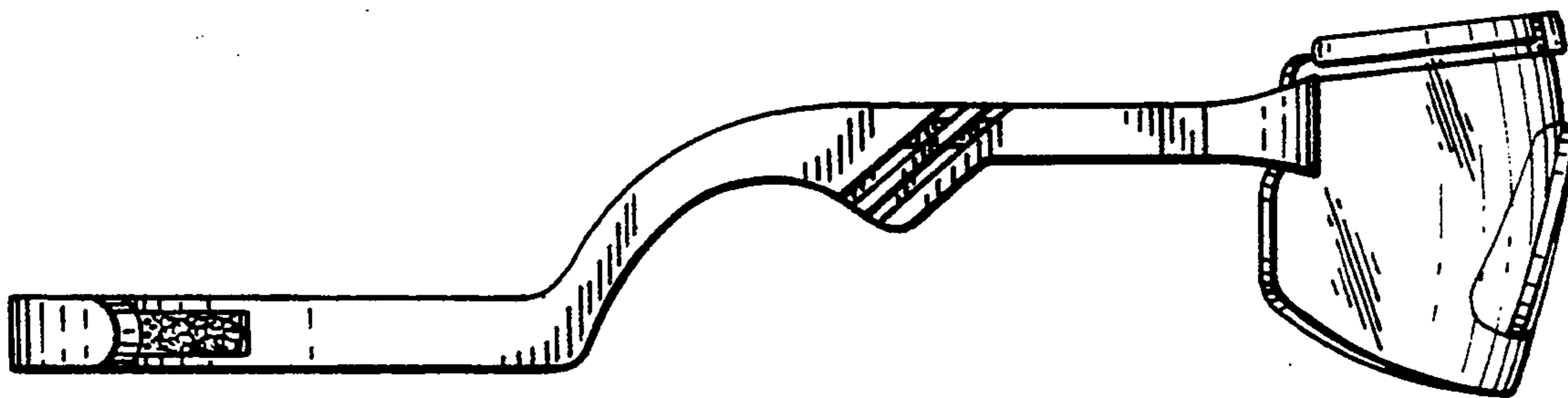
*FIG. 24*



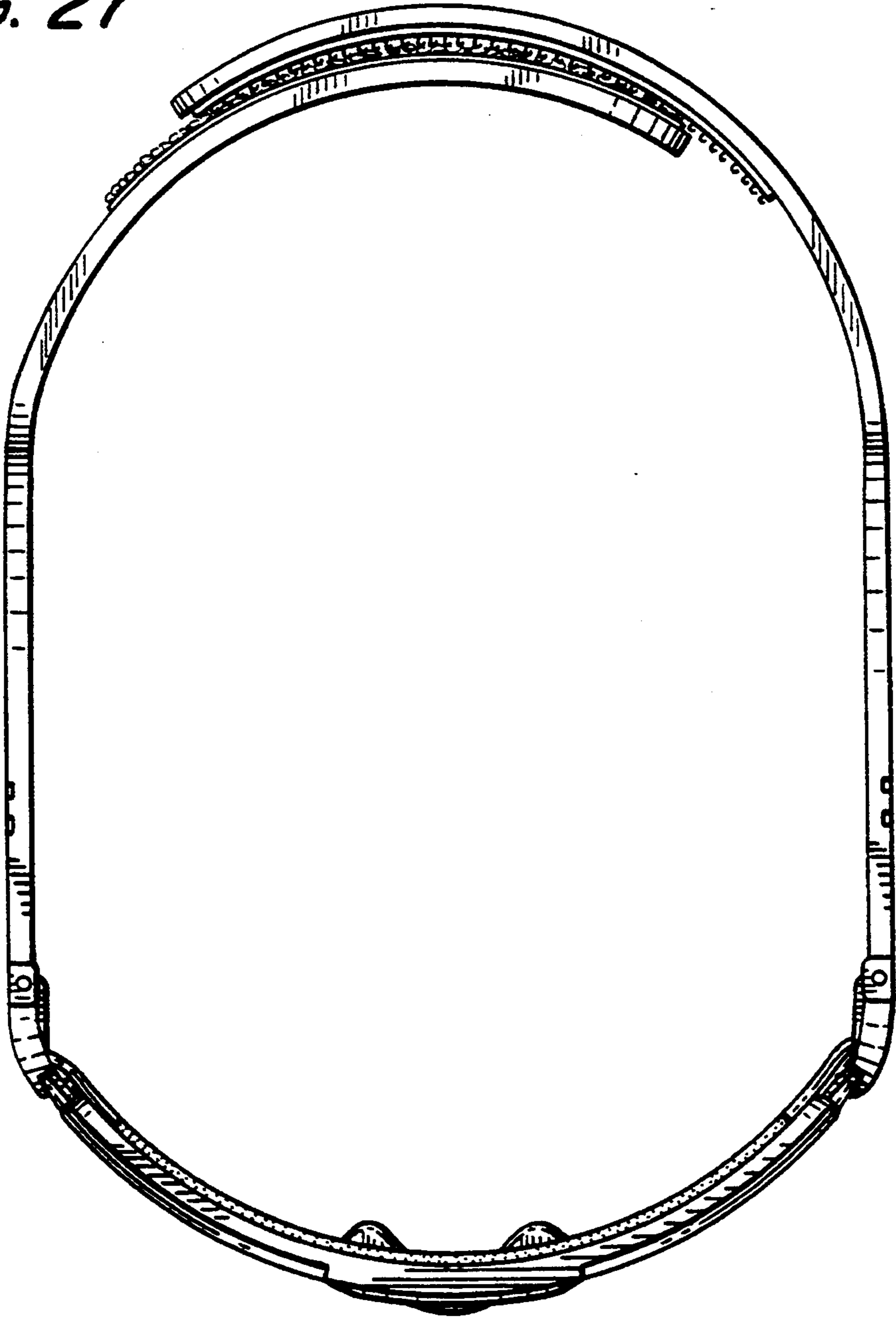
*FIG. 25*



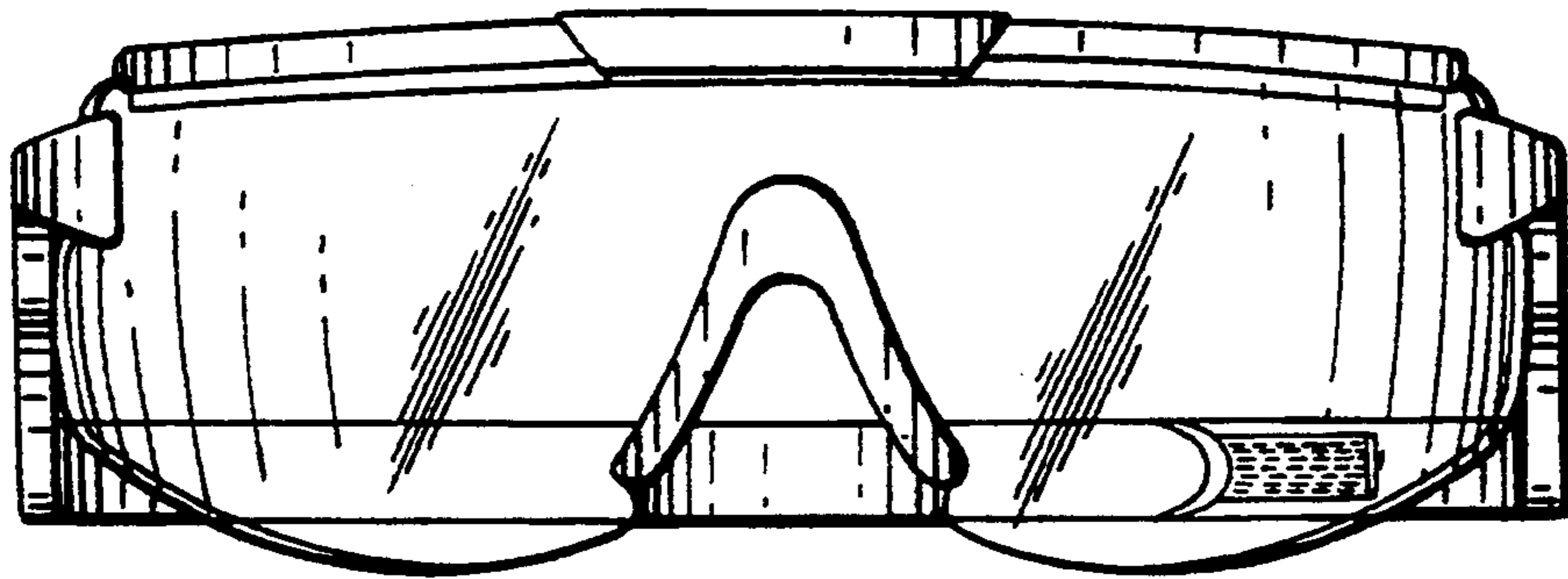
*FIG. 26*



*FIG. 27*

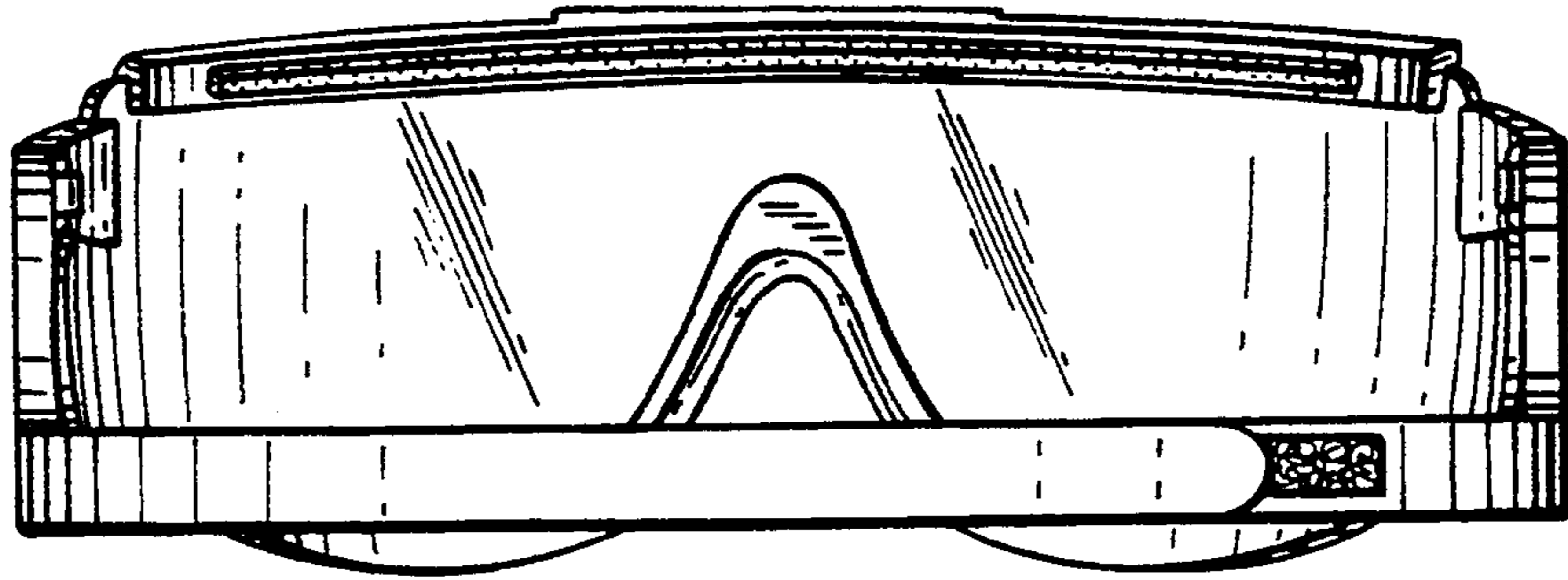


*FIG. 28*

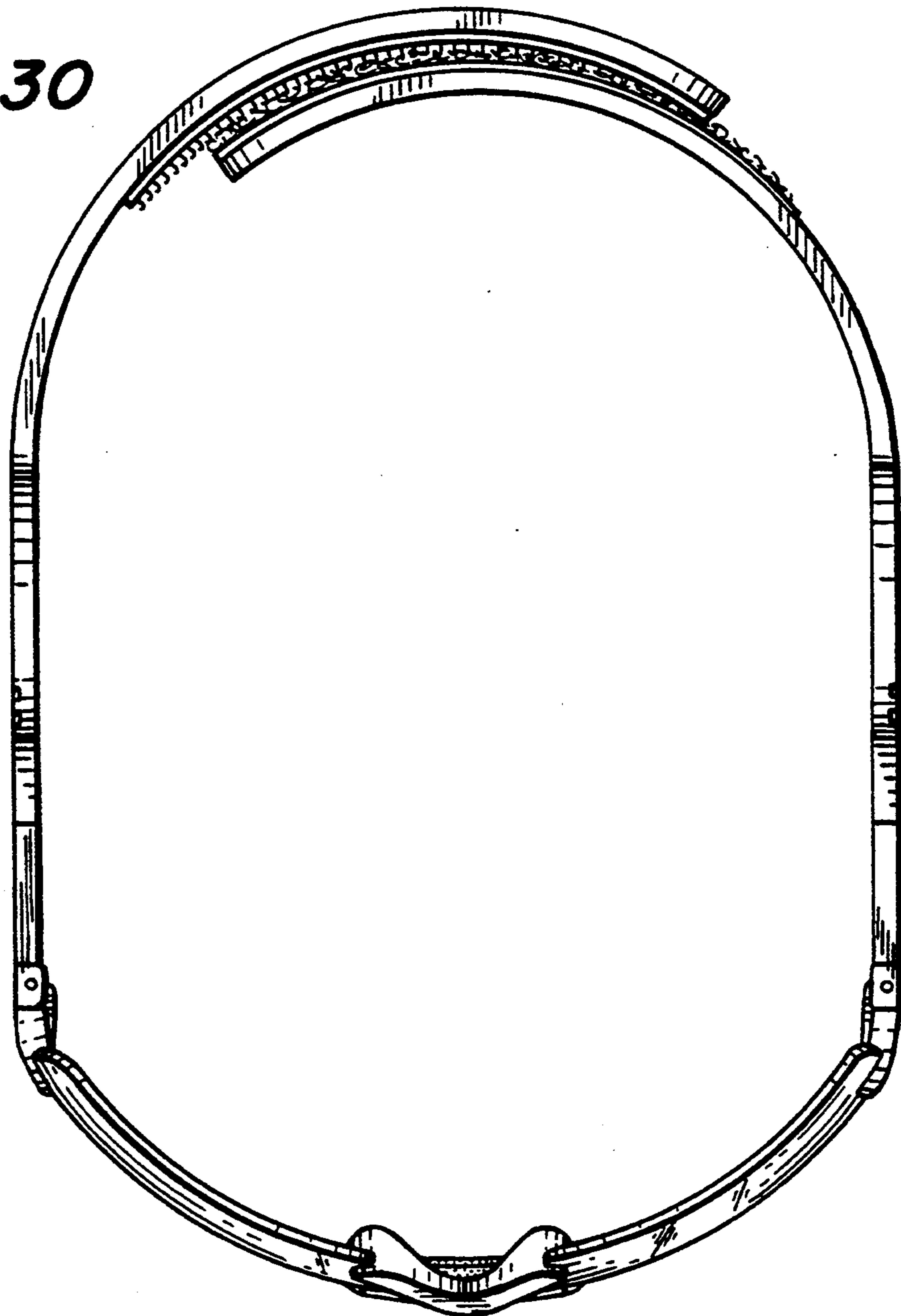




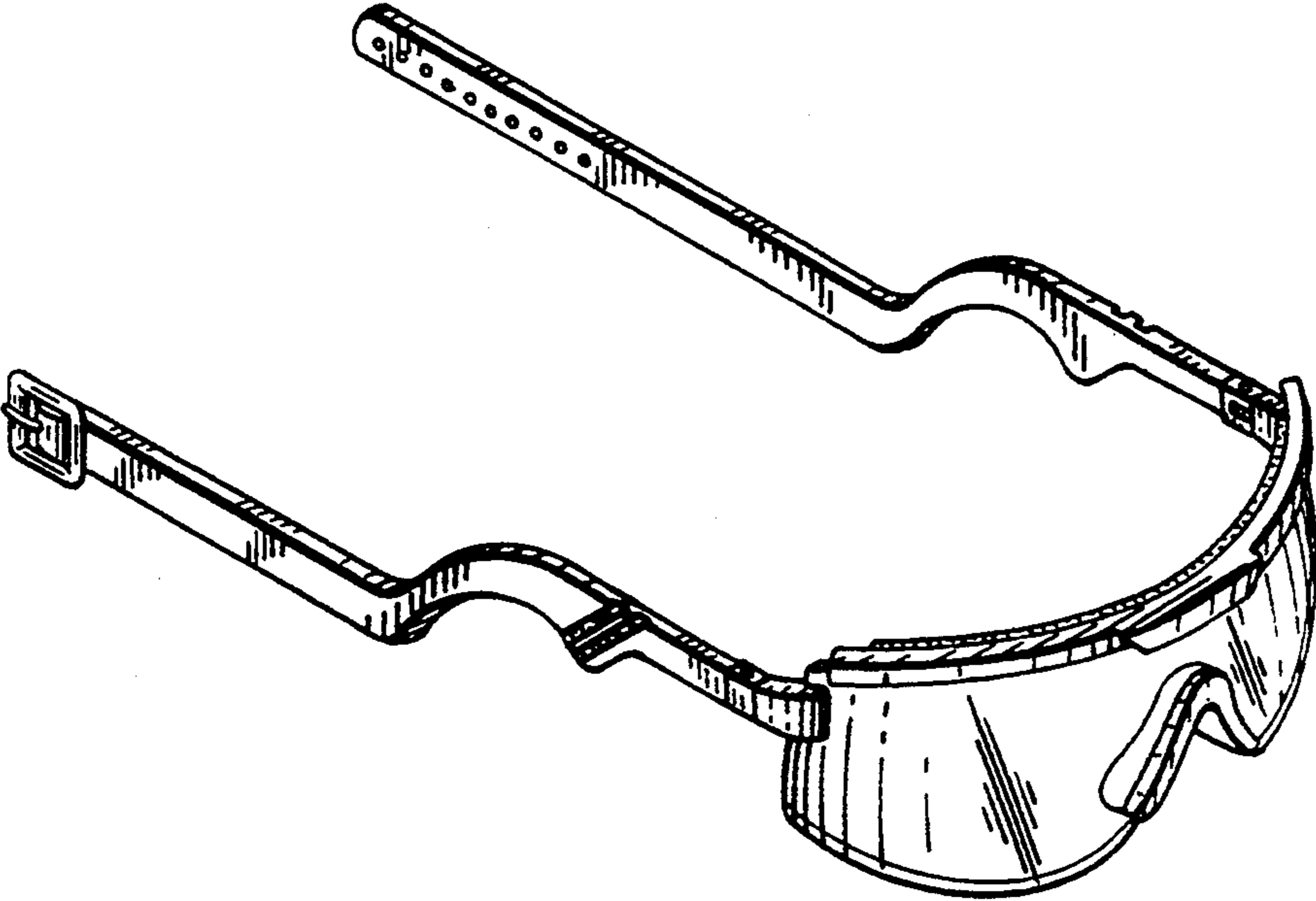
*FIG. 29*



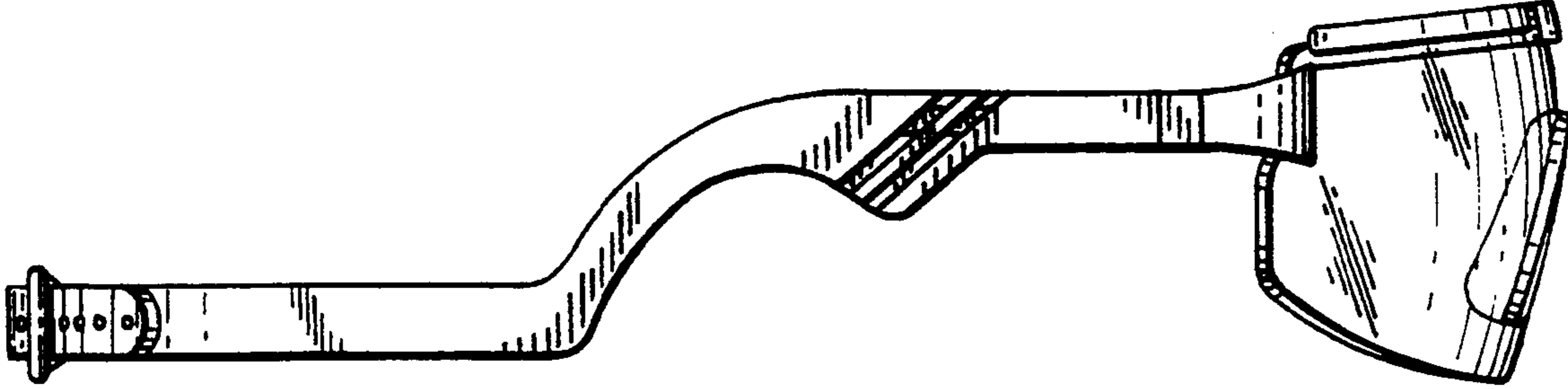
*FIG. 30*



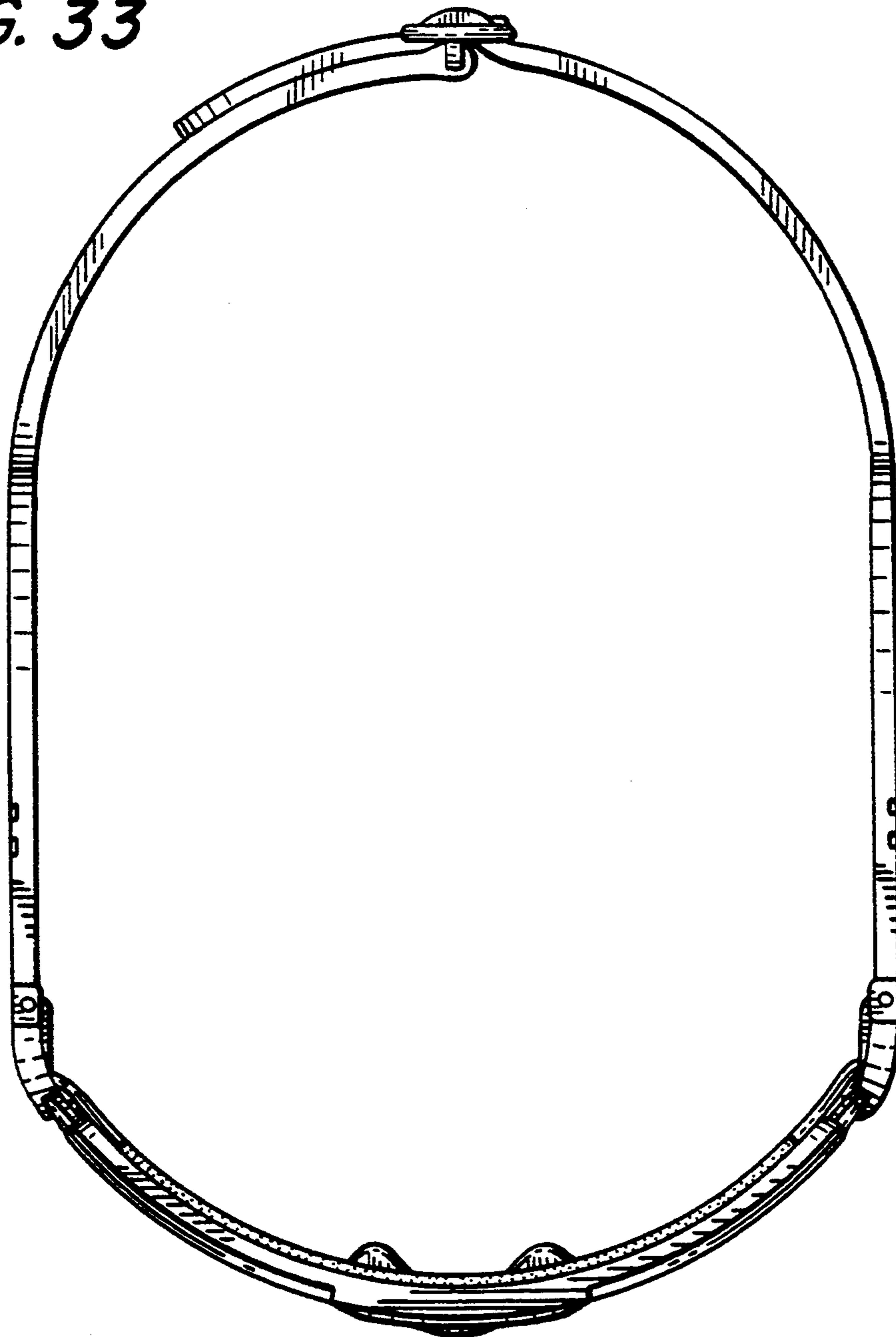
*FIG. 31*



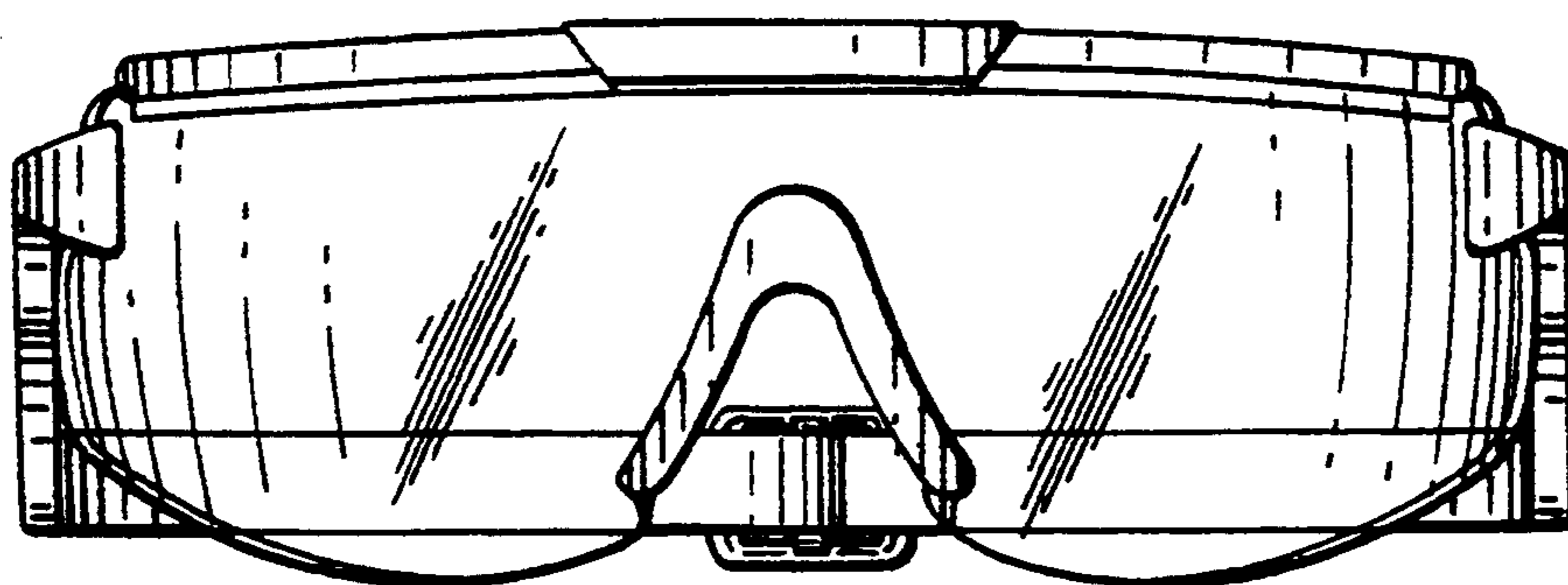
*FIG. 32*



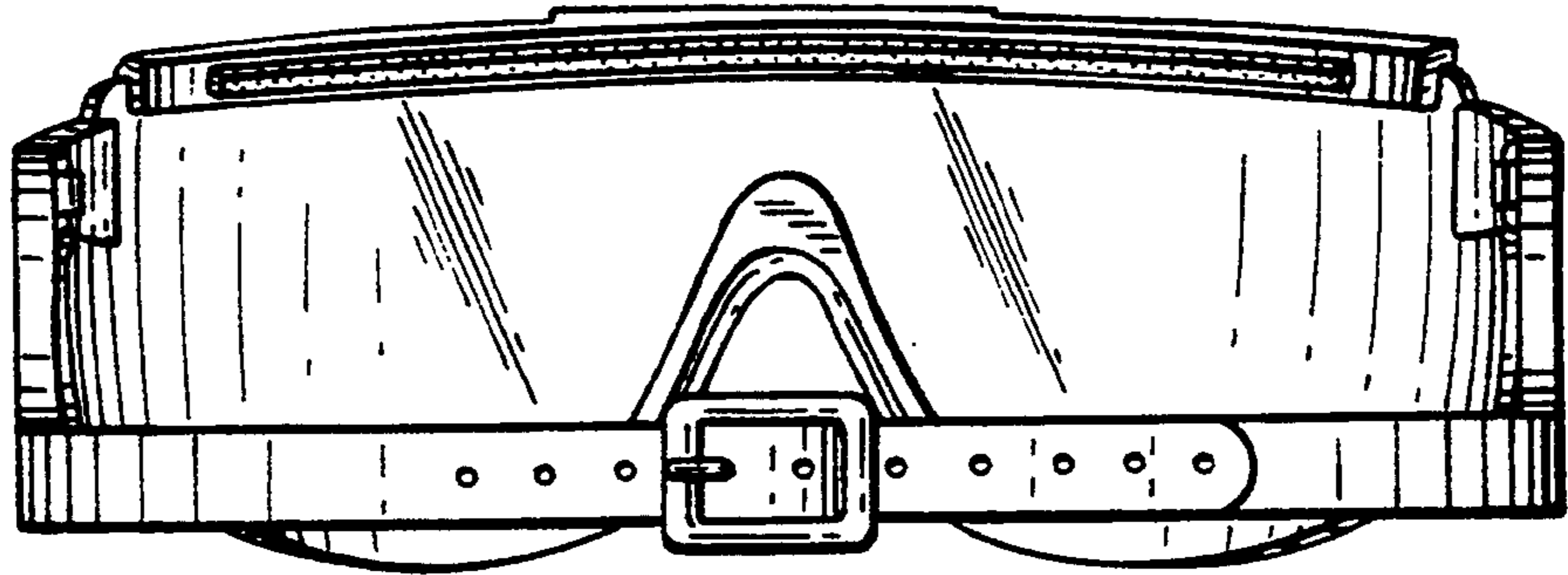
*FIG. 33*



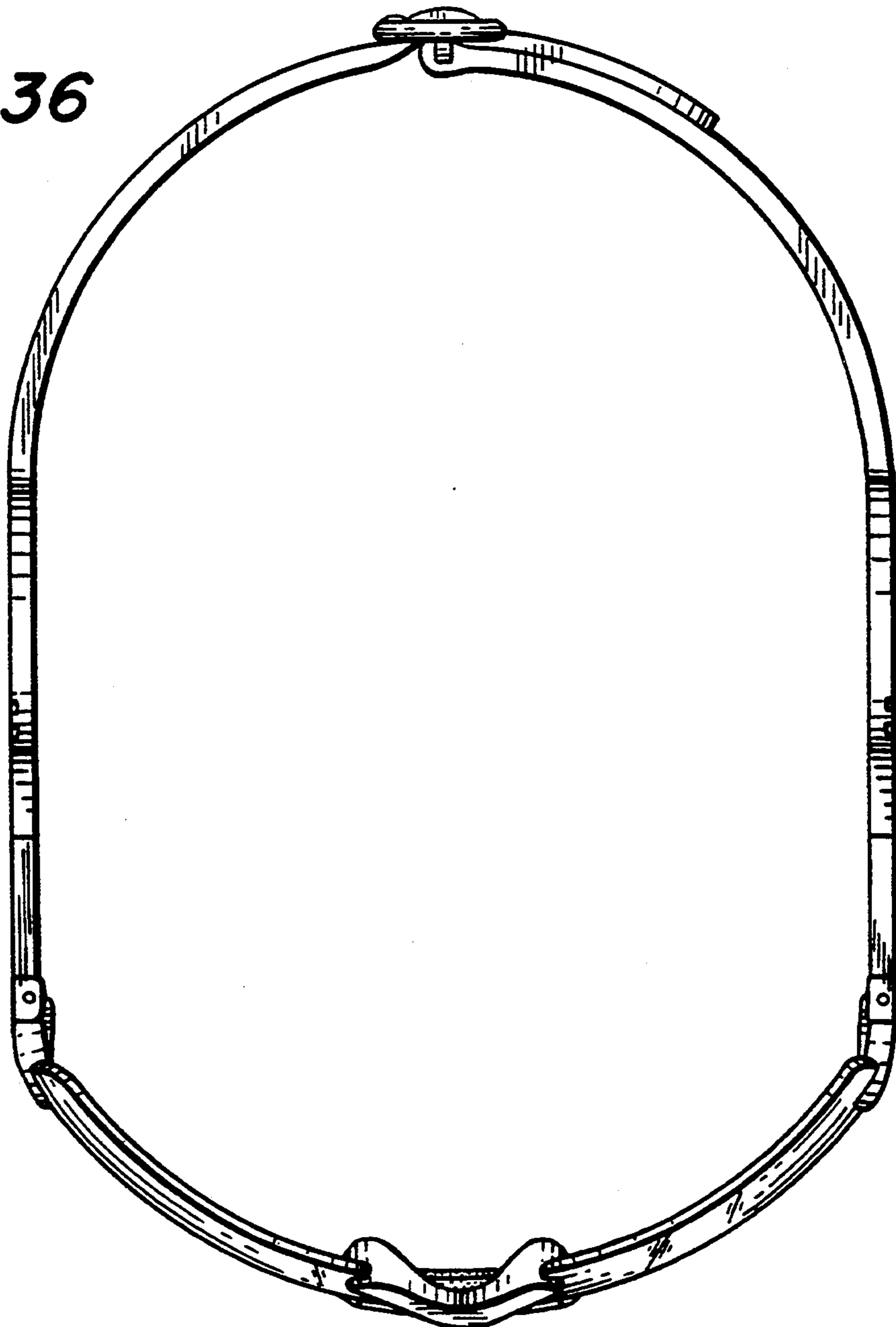
*FIG. 34*



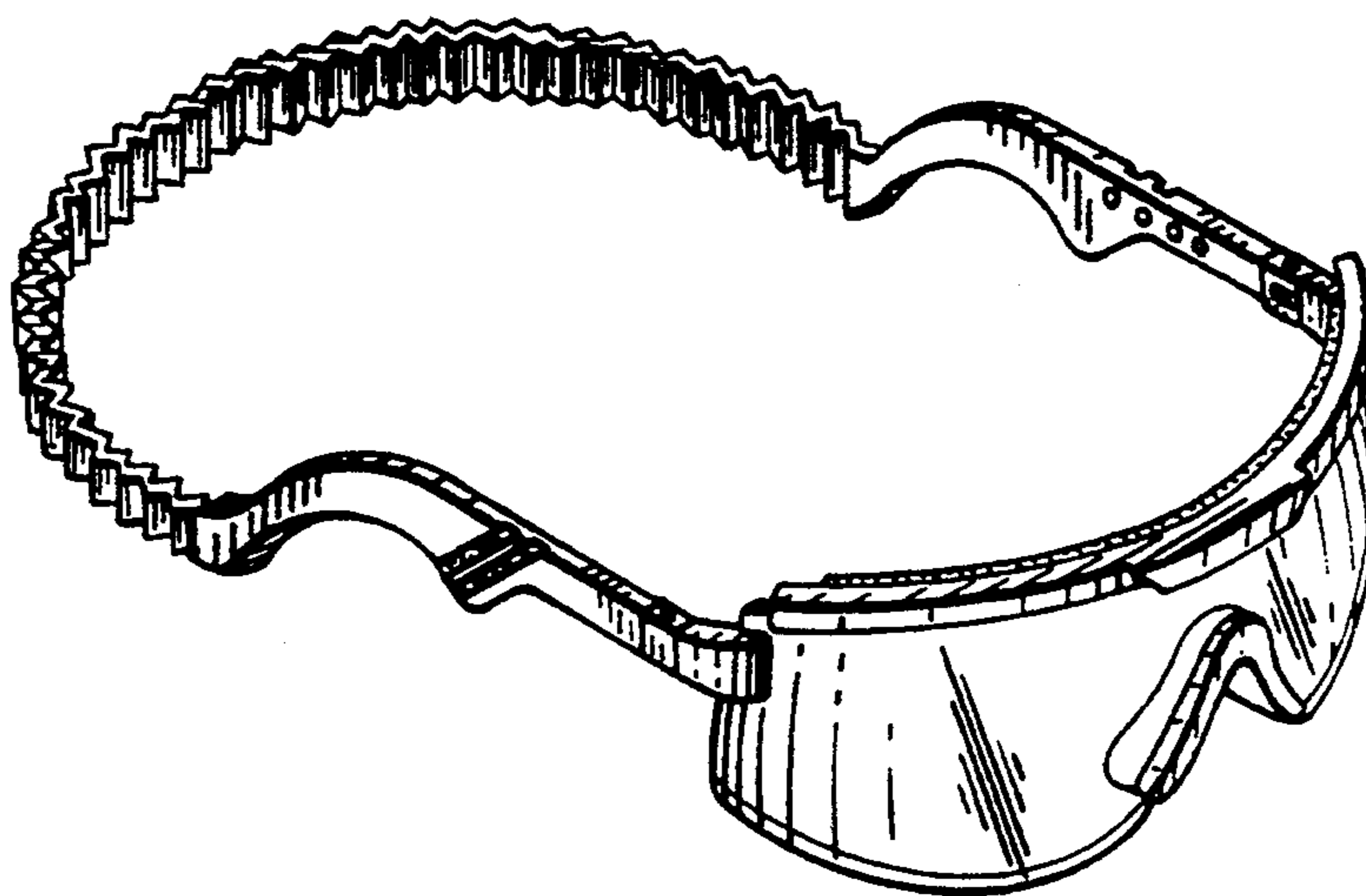
*FIG. 35*



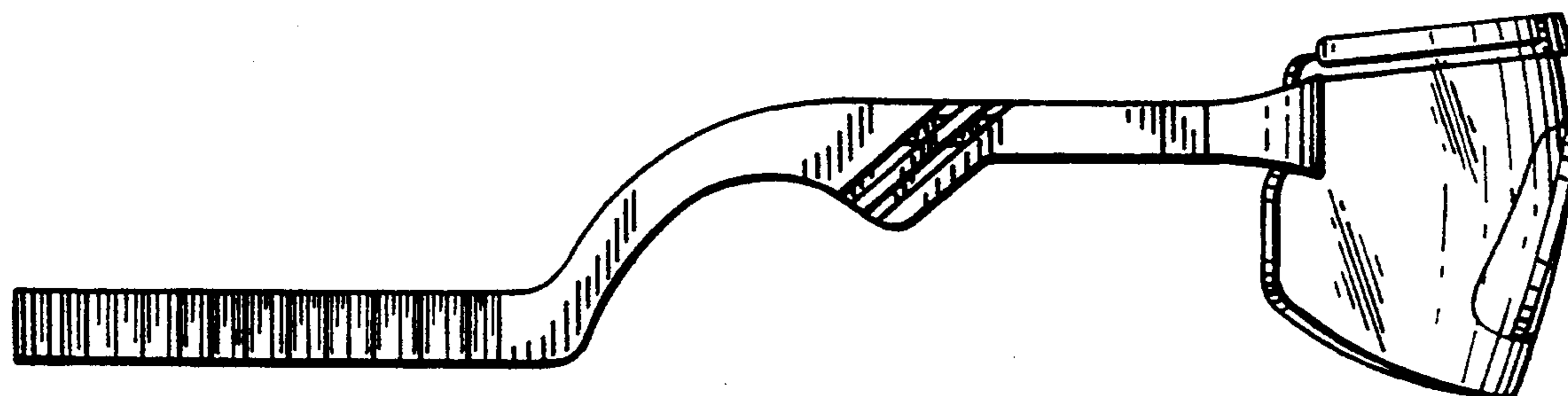
*FIG. 36*



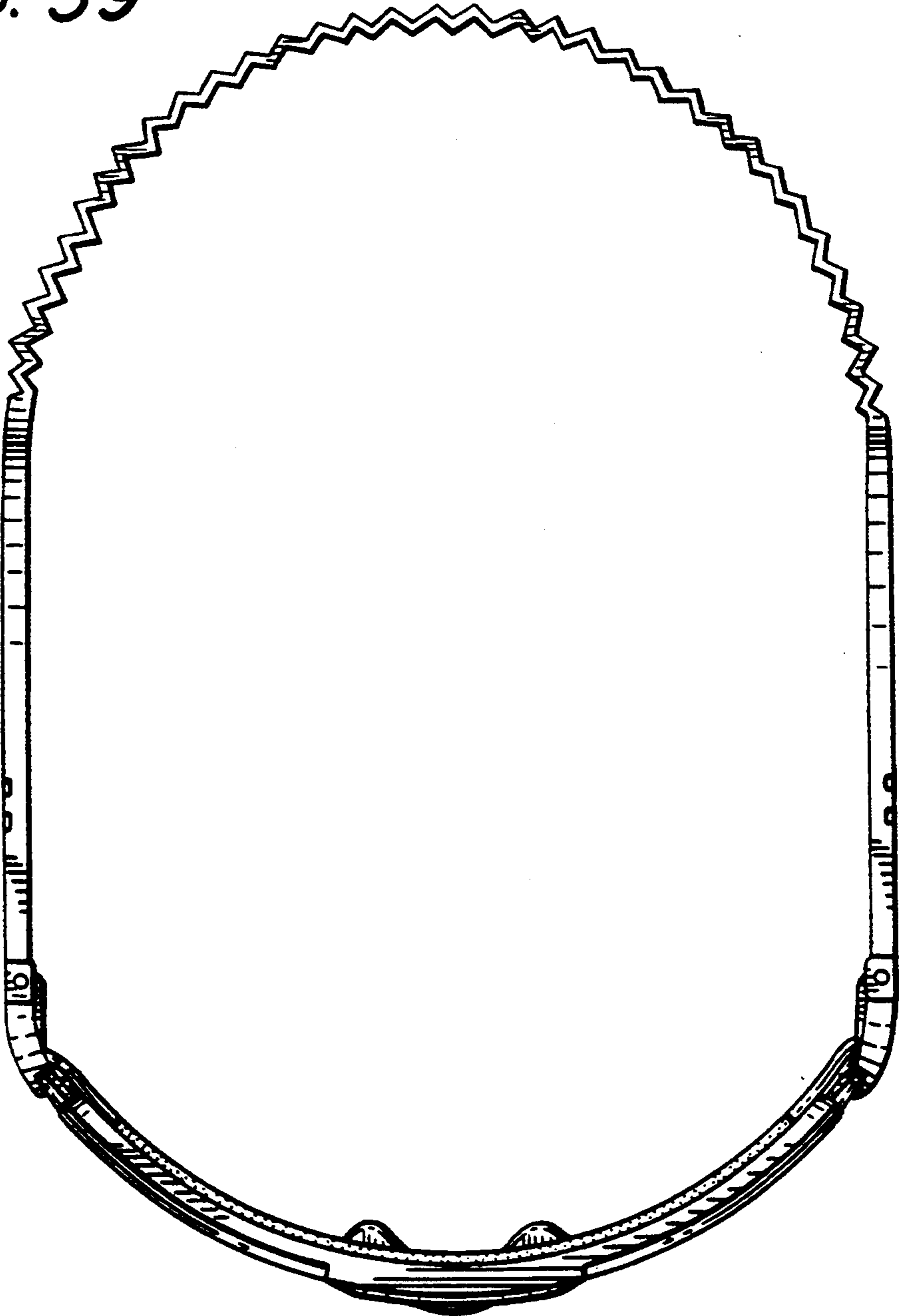
*FIG. 37*



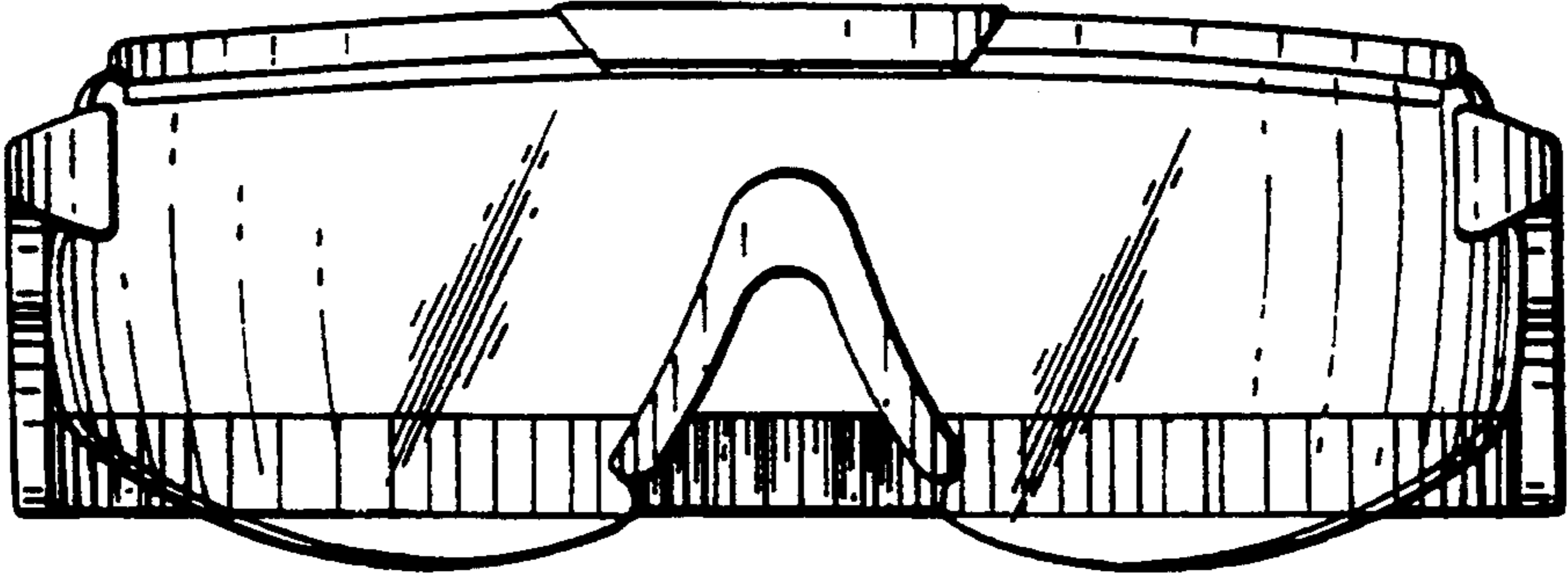
*FIG. 38*



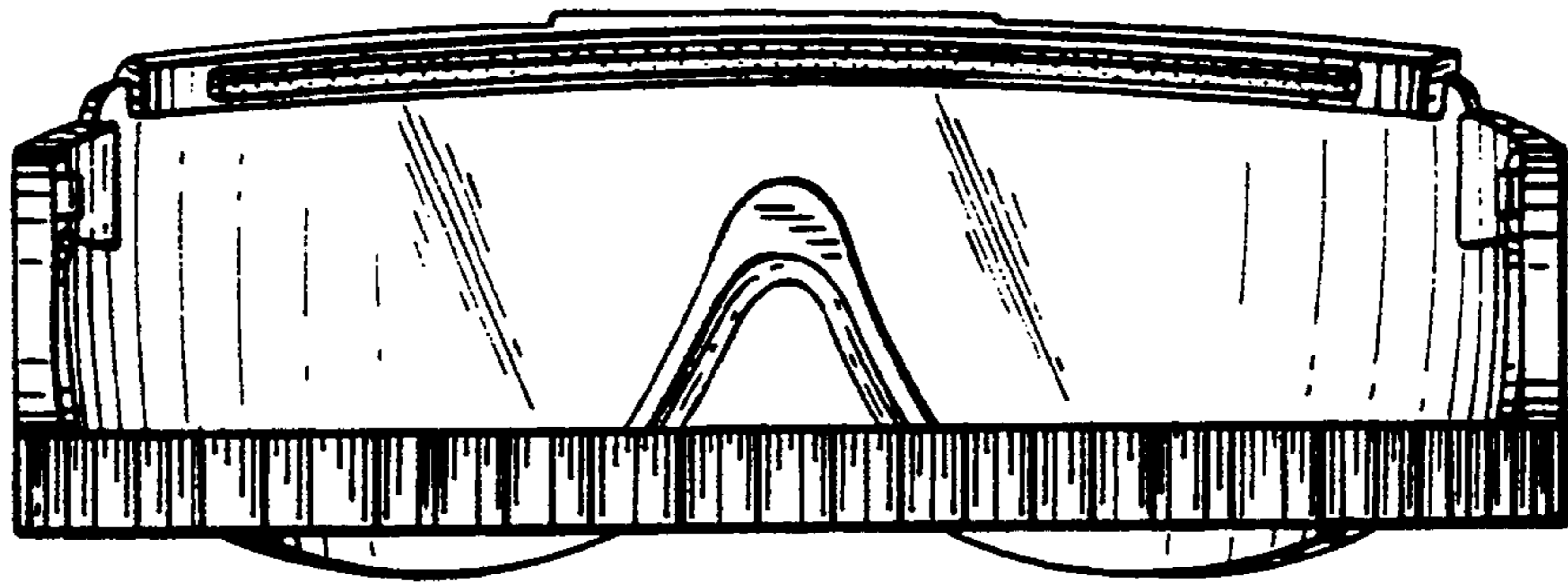
*FIG. 39*



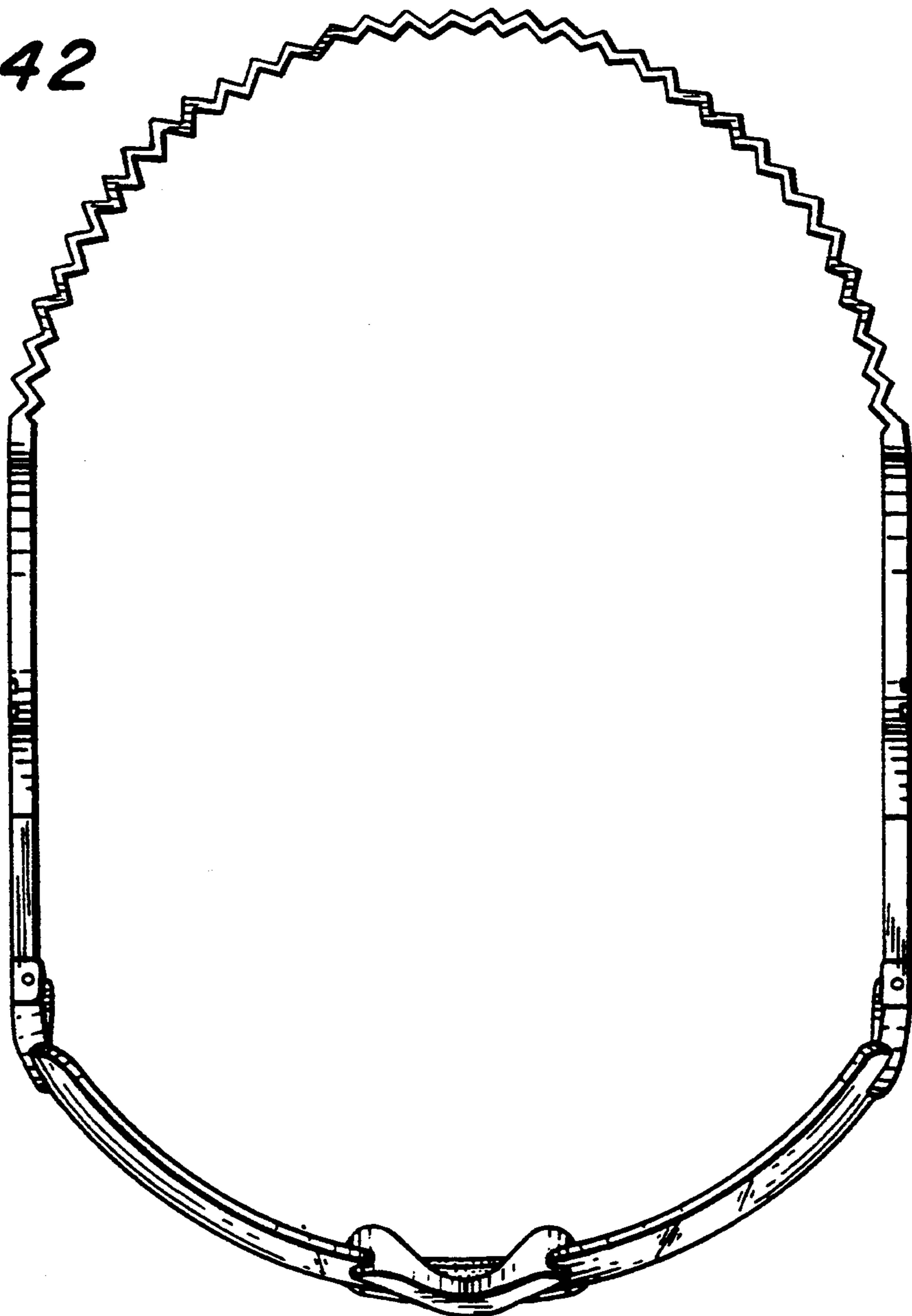
*FIG. 40*



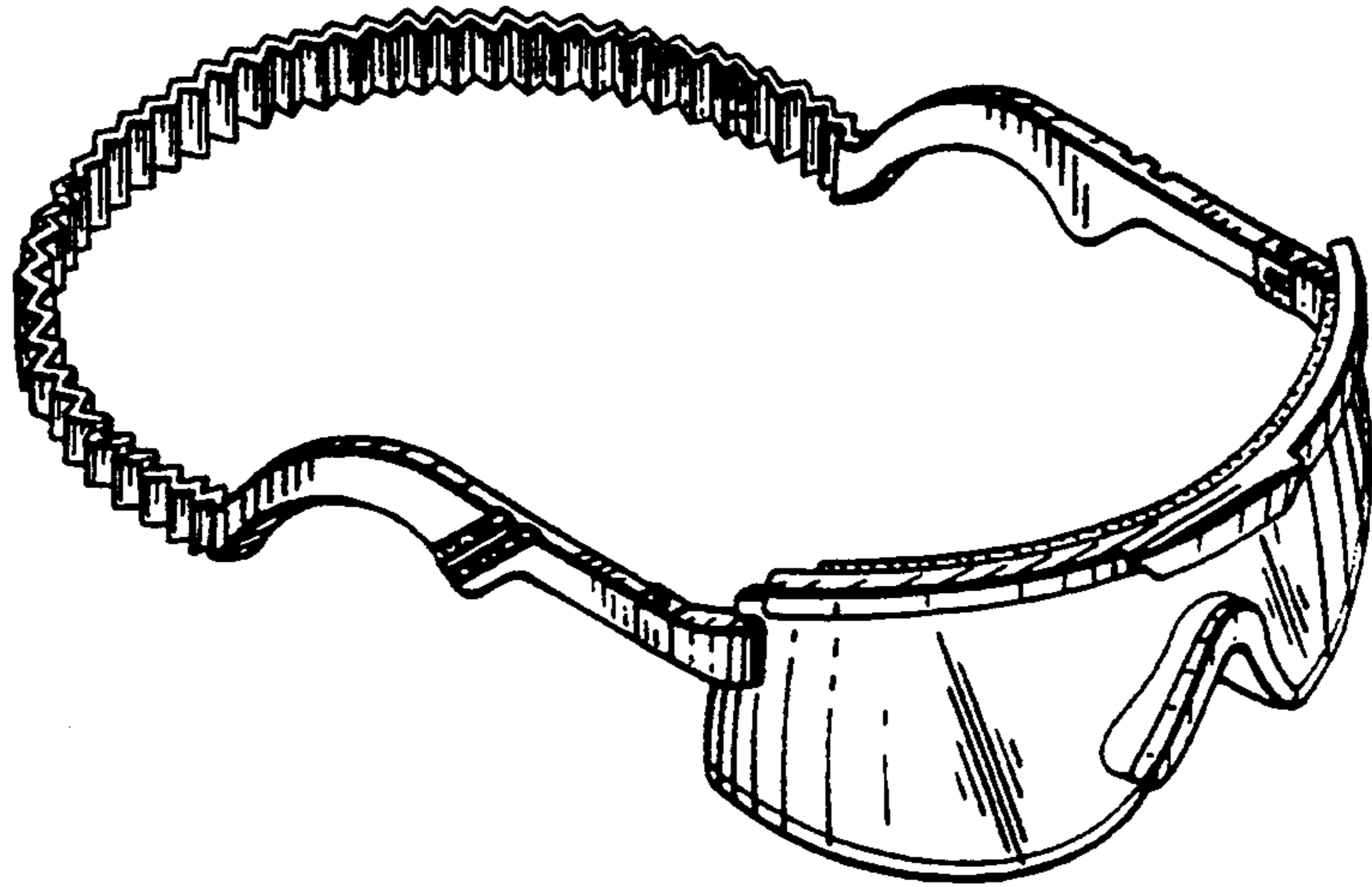
*FIG. 41*



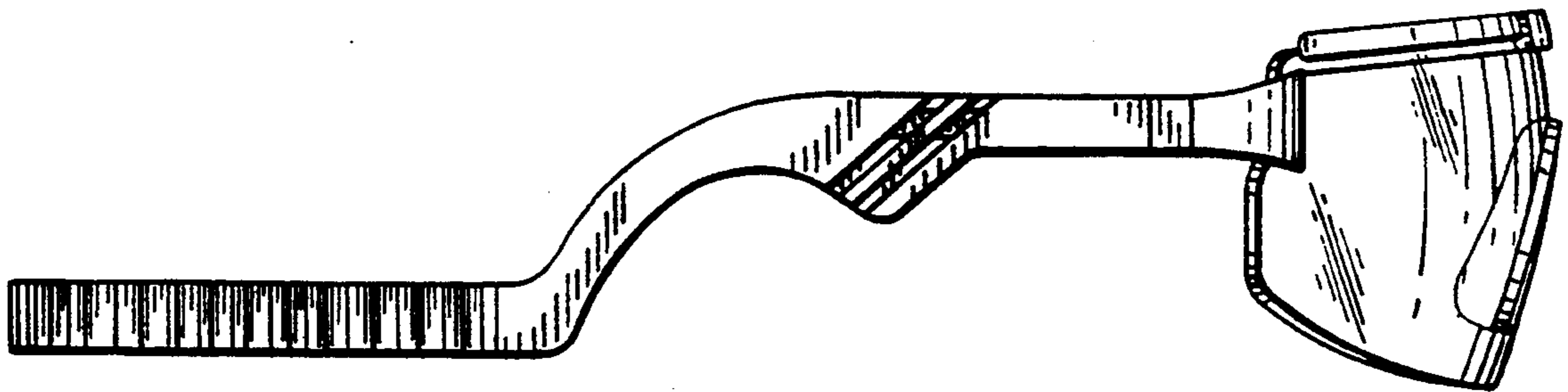
*FIG. 42*



*FIG. 43*

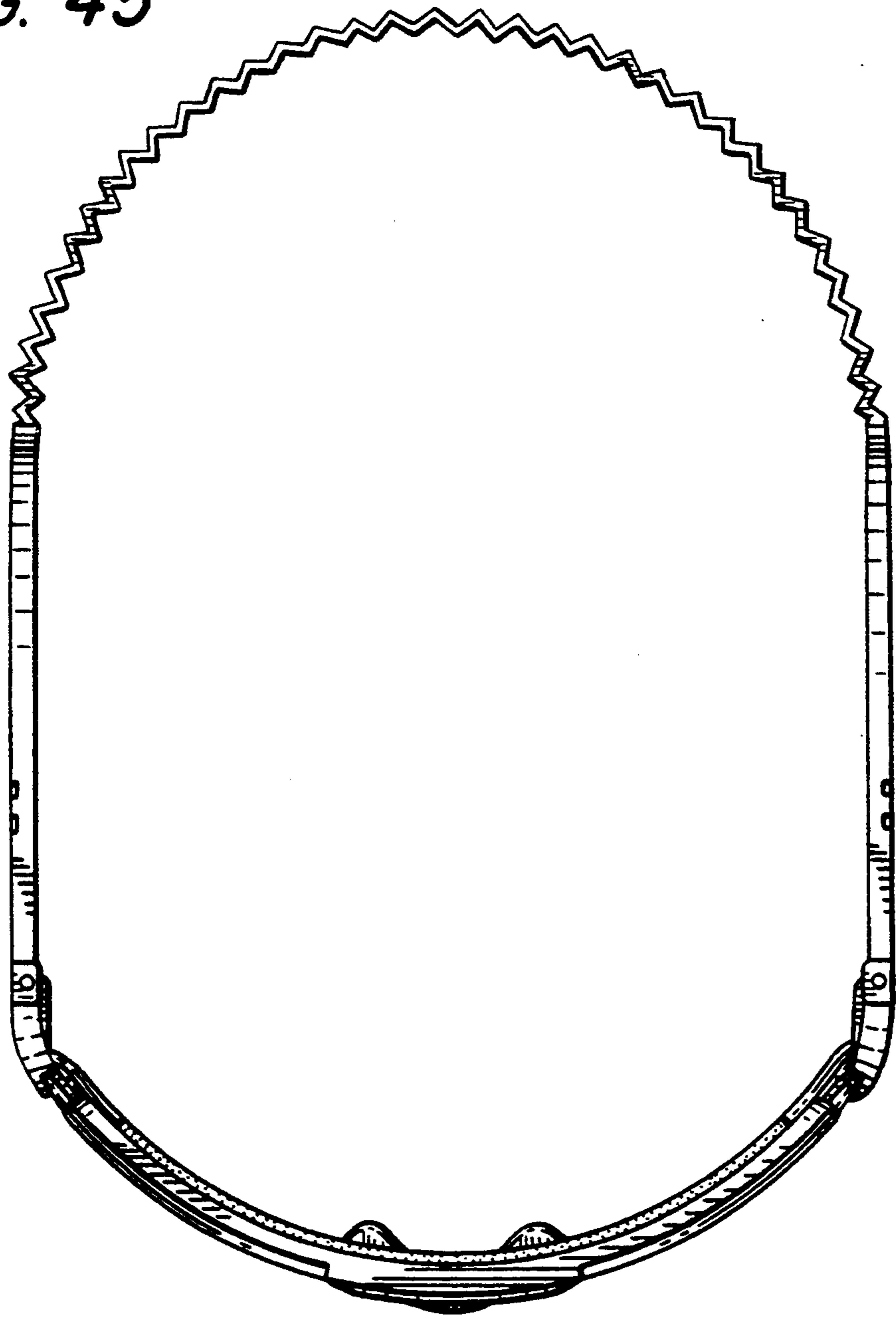


*FIG. 44*

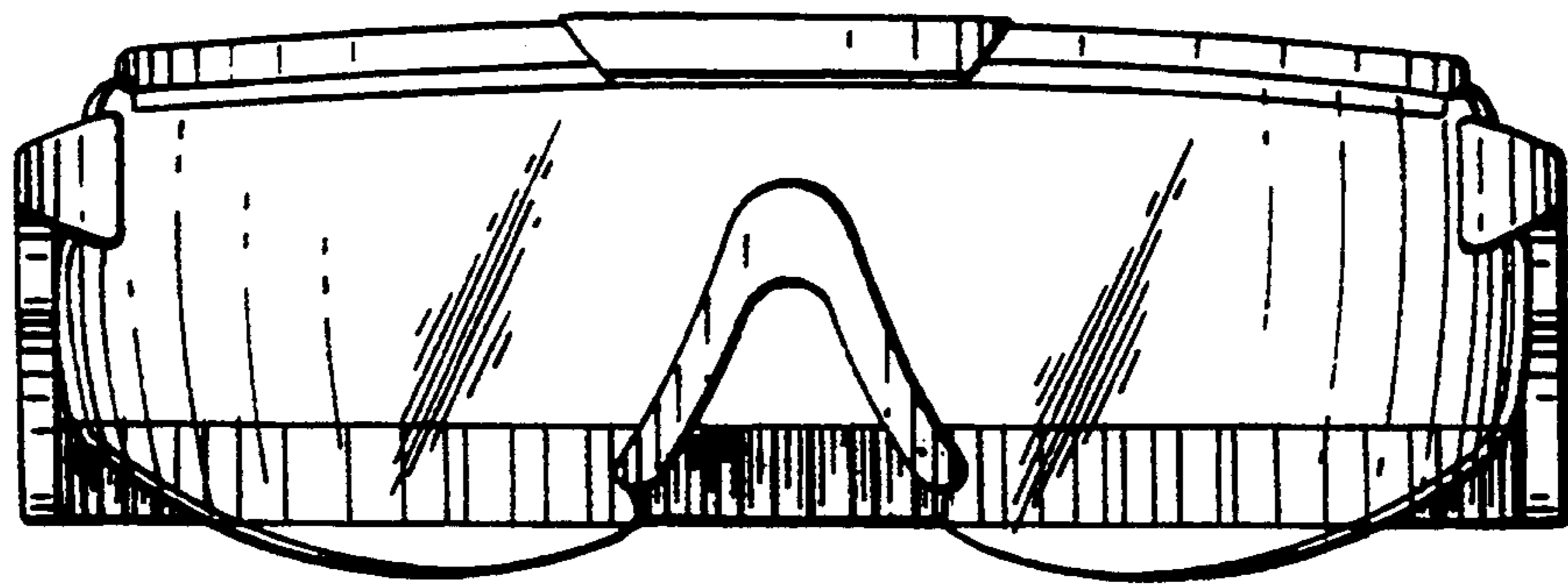




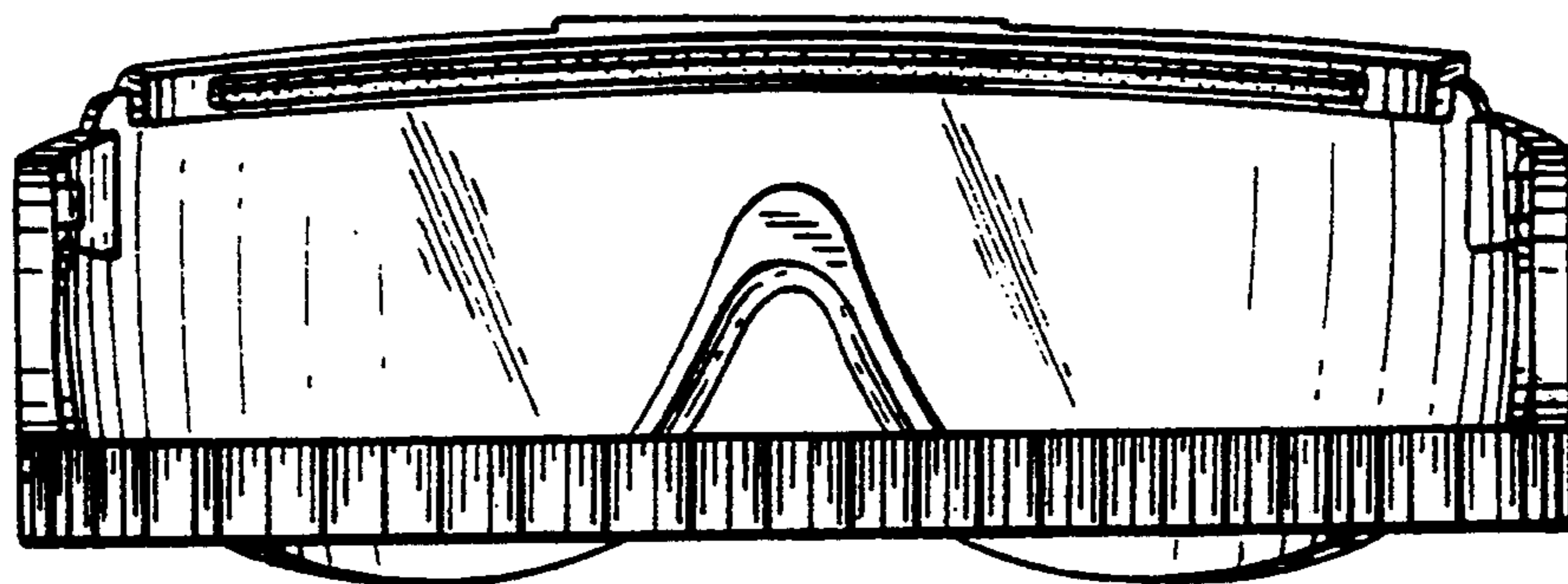
*FIG. 45*



*FIG. 46*



*FIG. 47*



*FIG. 48*

