



US00D353132S

United States Patent [19]

[11] Patent Number: **Des. 353,132**

Tinkham

[45] Date of Patent: **** Dec. 6, 1994**

- [54] **ACTUATOR HOUSING**
- [75] Inventor: **Ronald B. Tinkham**, Solana Beach, Calif.
- [73] Assignee: **Systems Analysis and Integration, Inc.**, Orange, Calif.
- [**] Term: **14 Years**
- [21] Appl. No.: **12,572**
- [22] Filed: **Sep. 3, 1993**
- [52] U.S. Cl. **D13/174**
- [58] Field of Search 361/600, 601, 605, 616; 200/146 R, 48 R; 623/24; D15/1-7; D13/152, 158, 173

- 4,095,061 6/1978 Bridges .
- 4,596,906 6/1986 Chabala et al. .
- 4,622,443 11/1986 Mooz .
- 5,249,097 9/1993 Bassin 361/600

Primary Examiner—Ralf T. Seifert
Attorney, Agent, or Firm—Knobbe, Martens, Olson & Bear

[57] CLAIM

The ornamental design for an actuator housing, as shown and described.

DESCRIPTION

FIG. 1 is a front perspective view of an actuator housing showing my new and ornamental design; FIG. 2 is a right side elevational view thereof; FIG. 3 is a left side elevational view thereof; FIG. 4 is a top plan view thereof; FIG. 5 is a bottom plan view thereof; FIG. 6 is a rear elevational view thereof; and, FIG. 7 is a front elevational view thereof.

The broken line showing of a base and connecting rods in FIG. 1 and connector and plug in FIGS. 1-4 and 7 is for illustrative purposes only and forms no part of the claimed design.

[56] References Cited U.S. PATENT DOCUMENTS

- D. 331,411 12/1992 Kassouni D15/5
- D. 336,636 6/1993 Veno et al. D3/173
- 3,233,071 2/1966 Buzzell .
- 3,499,129 3/1970 Hulteen et al. 200/48 R
- 3,594,525 7/1971 Miller .
- 3,662,128 5/1972 Neudorfer et al. .
- 4,051,340 9/1977 Wolski .

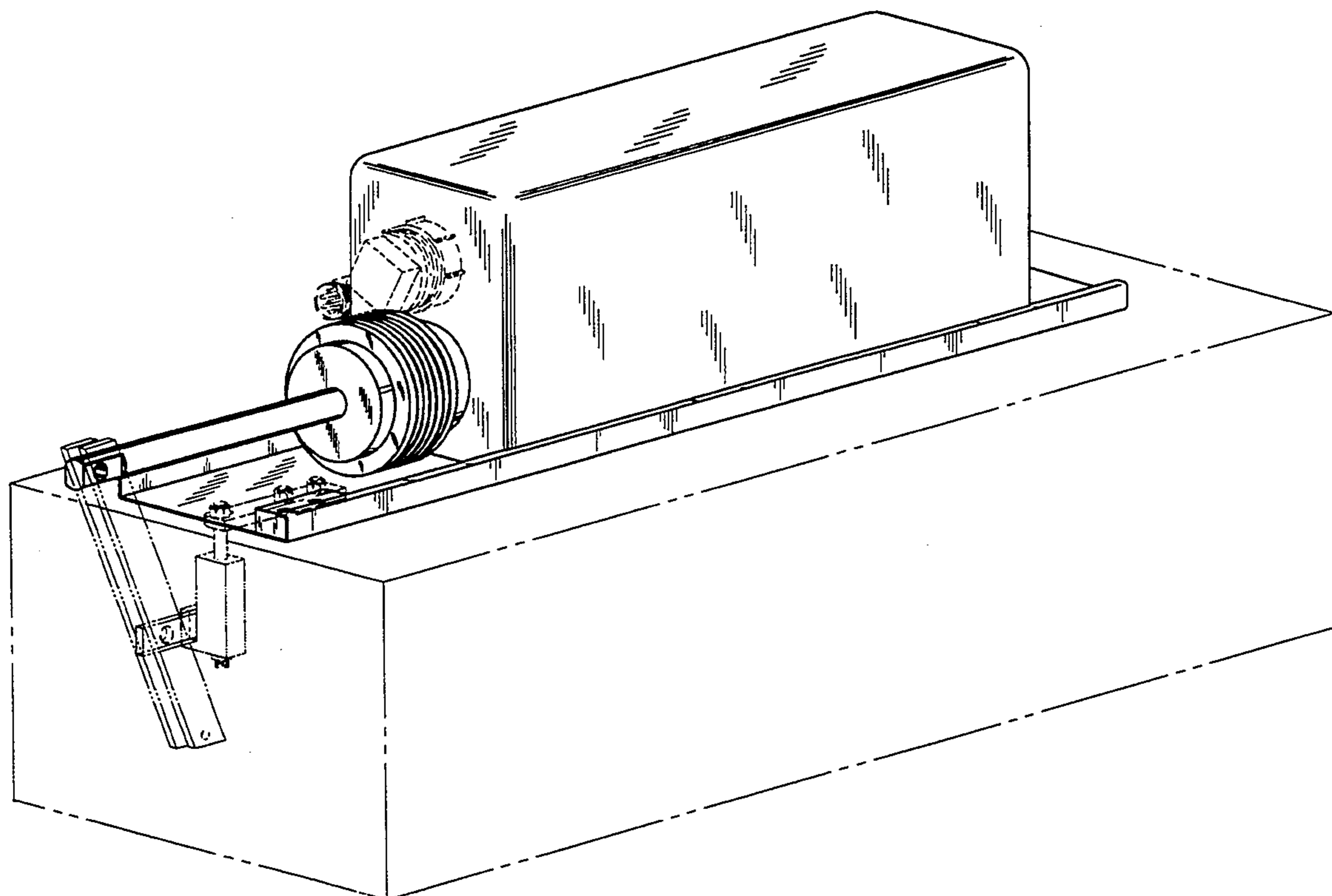

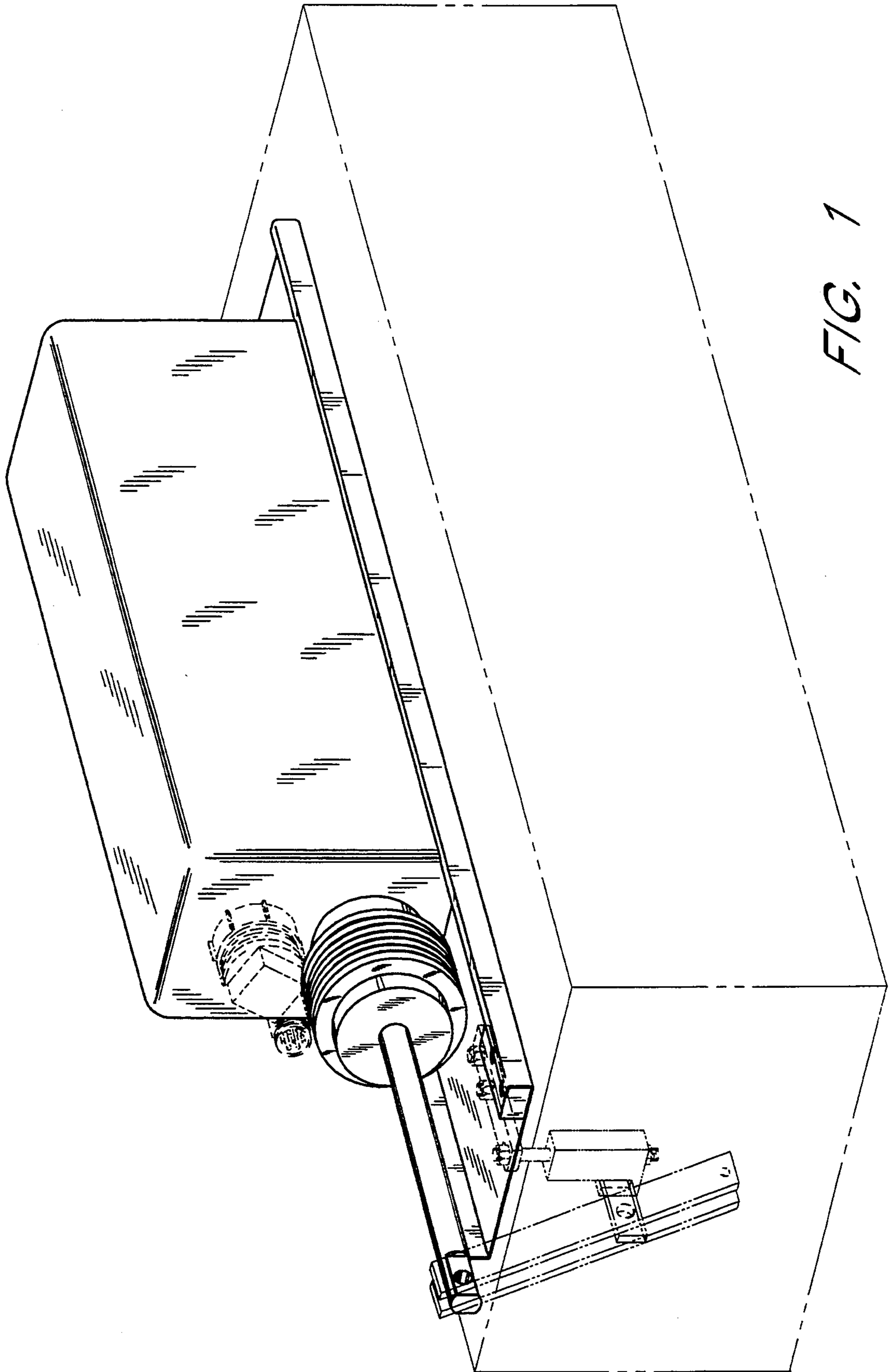

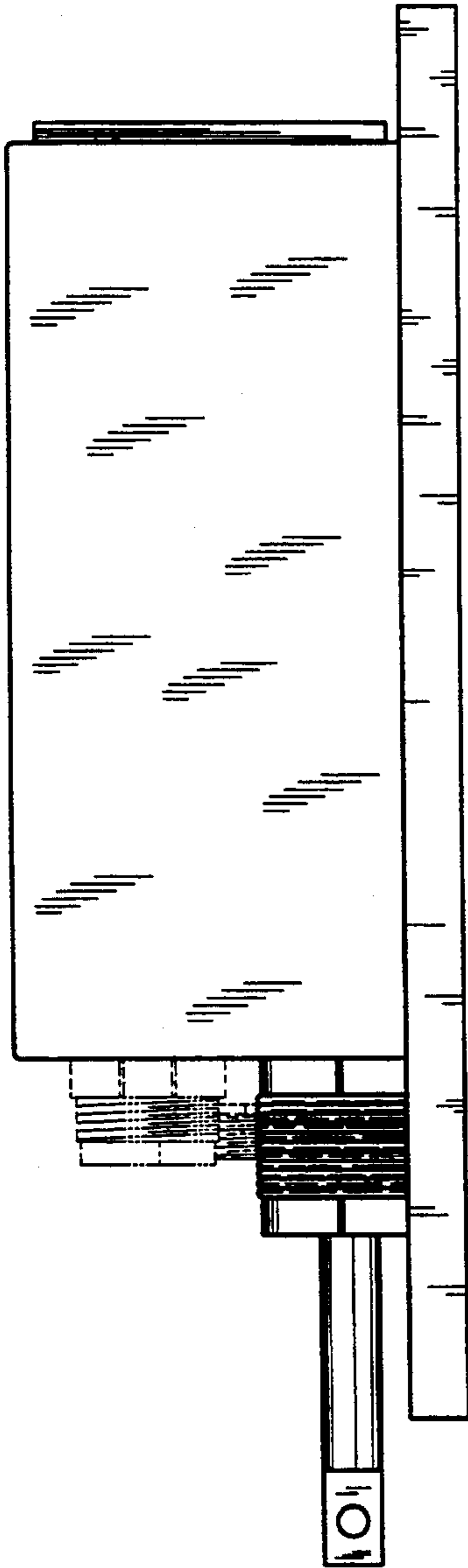

FIG. 2

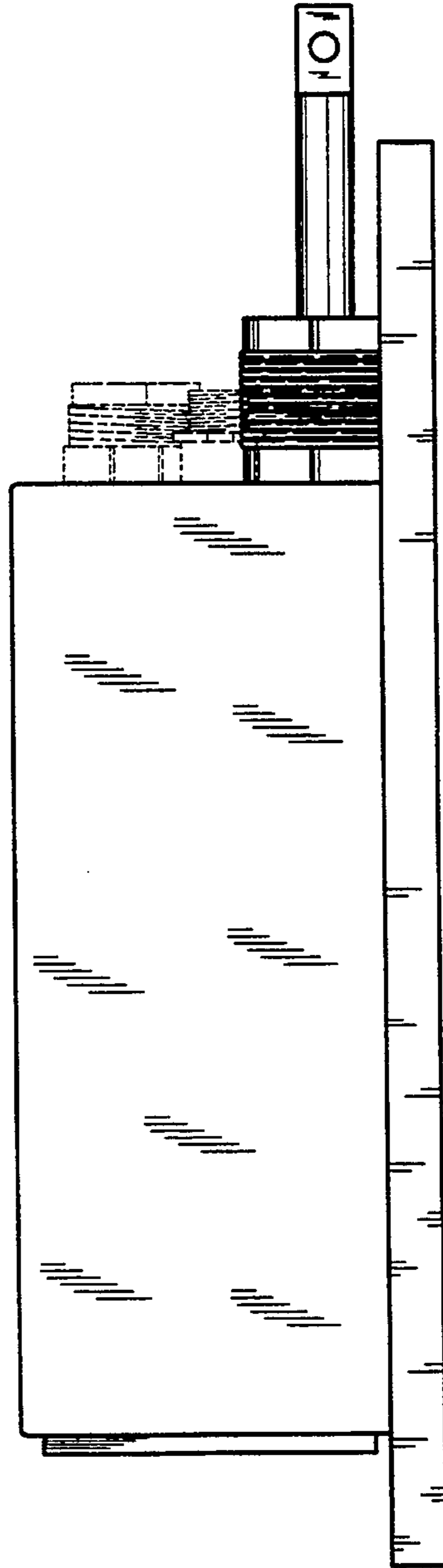

FIG. 3

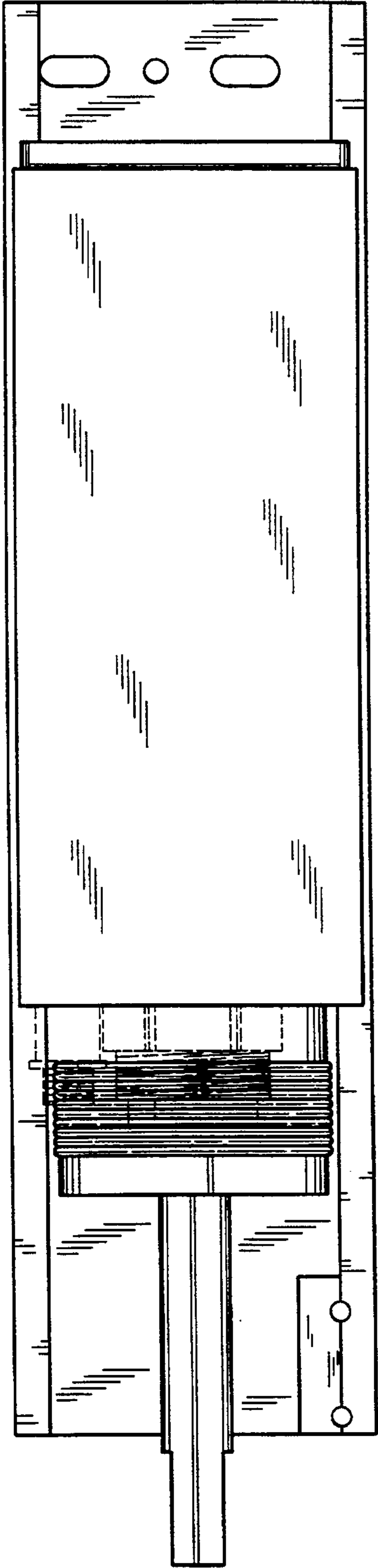

FIG. 4

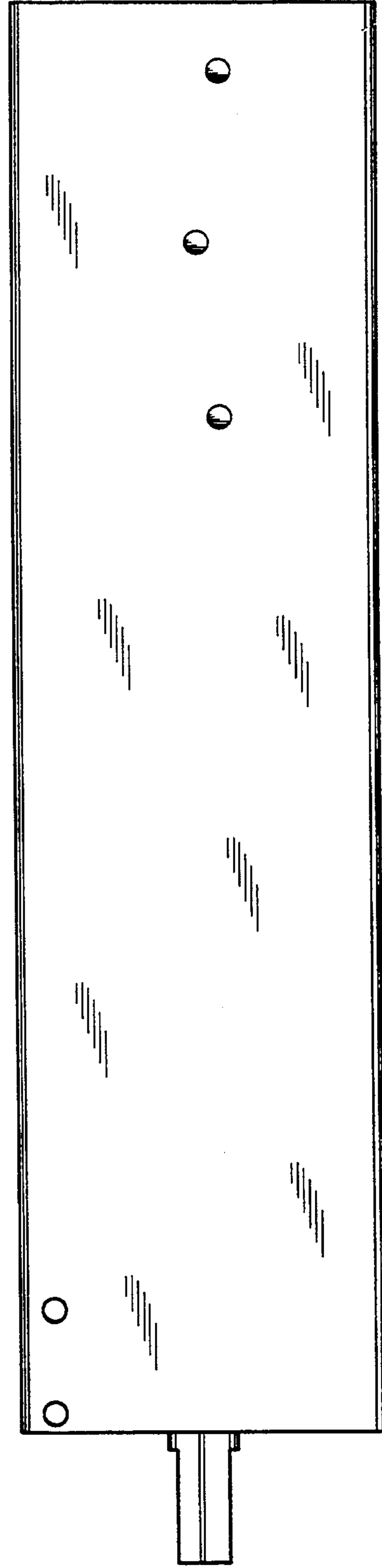

FIG. 5

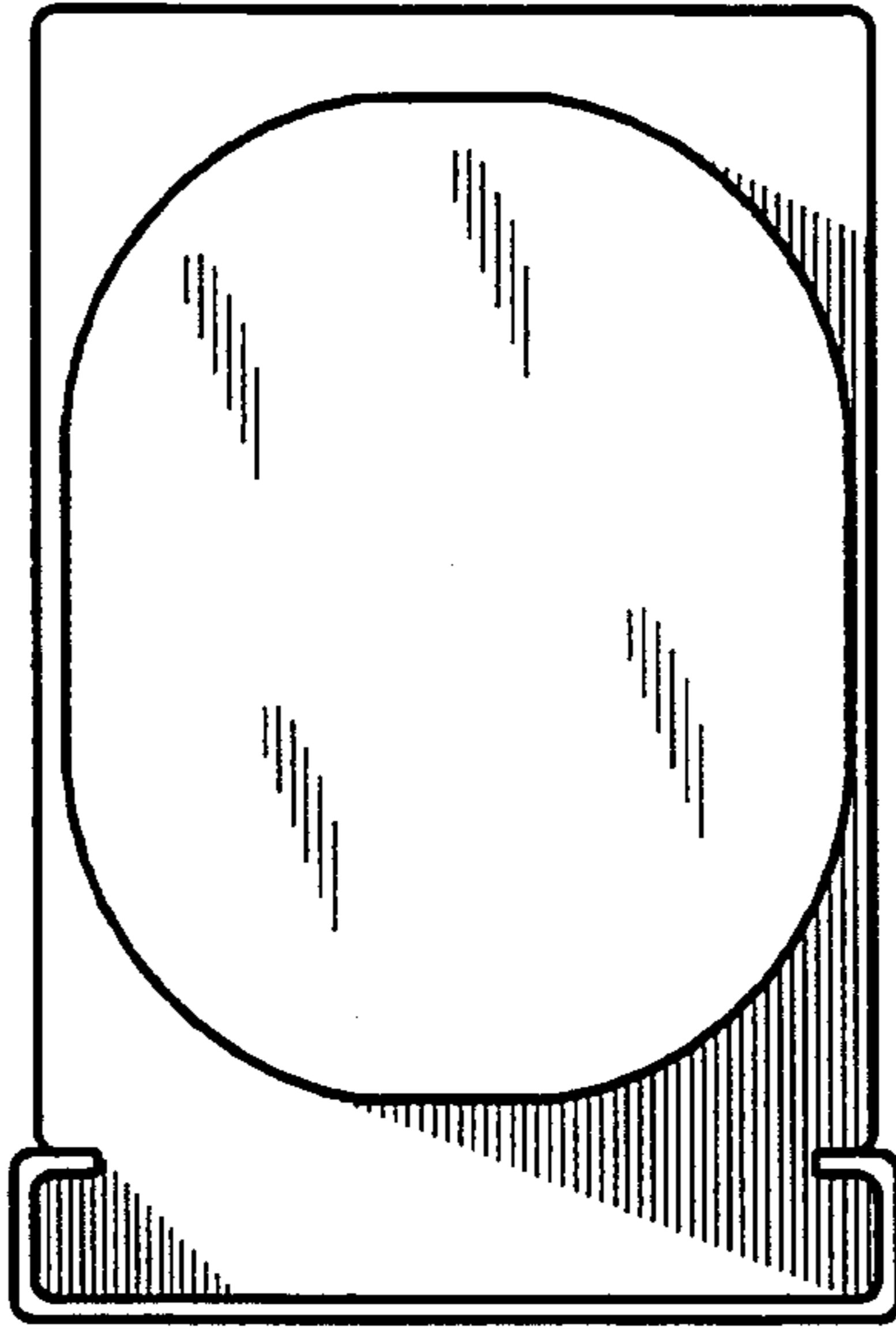

FIG. 6

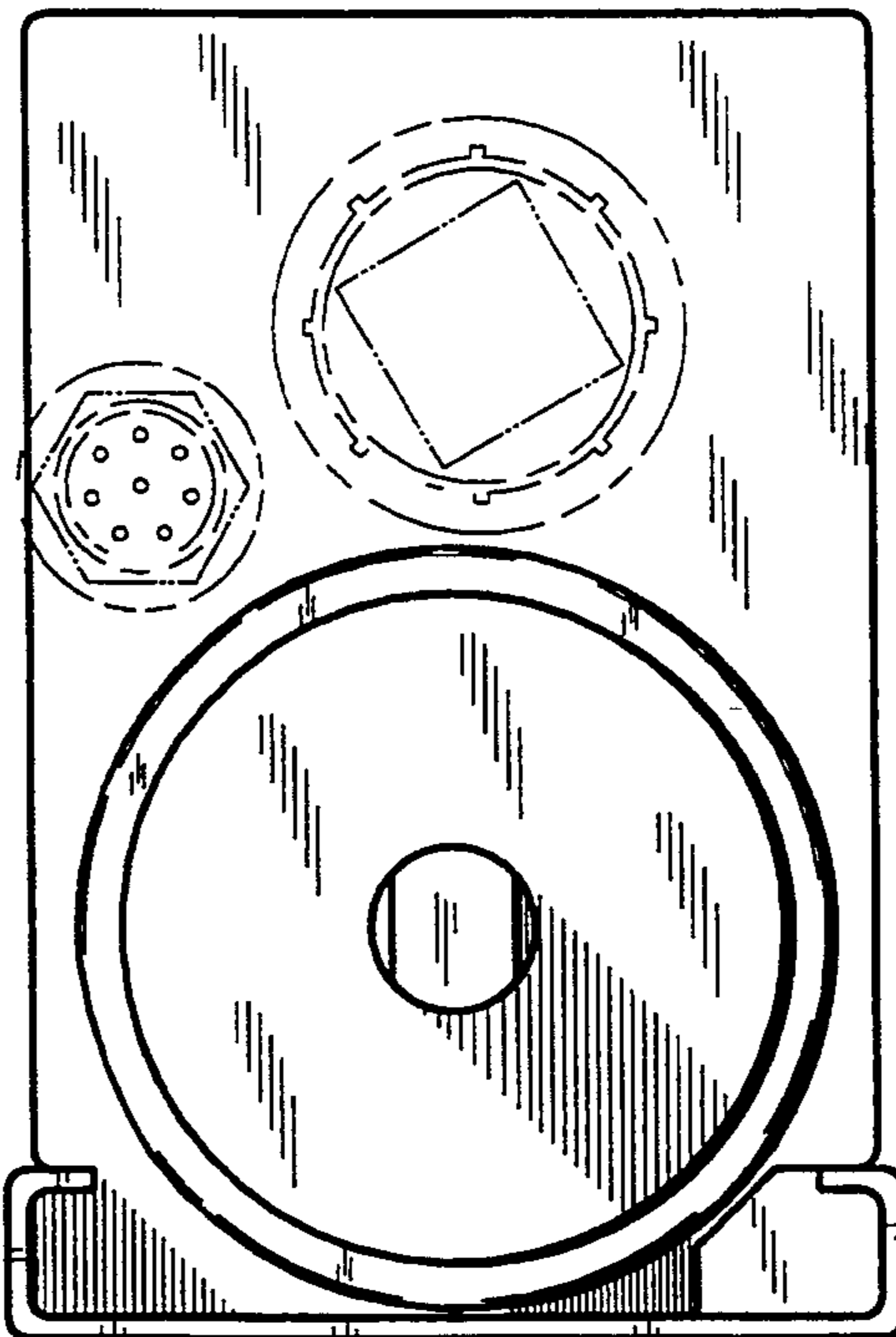

FIG. 7