



US00D352986S

United States Patent [19]

[11] Patent Number: **Des. 352,986**

Houry et al.

[45] Date of Patent: **** Nov. 29, 1994**

[54] **SANDBOX**

[75] Inventors: **Robert L. Houry**, Solon; **James R. Nagy**, Cuyahoga Falls, both of Ohio

[73] Assignee: **The Little Tikes Company**, Hudson, Ohio

[**] Term: **14 Years**

[21] Appl. No.: **6,994**

[22] Filed: **Apr. 13, 1993**

[52] U.S. Cl. **D21/252**

[58] Field of Search **472/116, 117, 126, 128; 446/70; D21/240-252**

FOREIGN PATENT DOCUMENTS

906062 9/1962 United Kingdom .

OTHER PUBLICATIONS

Sears Roebuck, 1955, p. 878.

Quality Play Equipment Cat. #21, 1979, p. 17 Sandbox. Pg. 19, Sandbox; Fisher-Price, 620 Girard Ave., East Aurora, NY 14052-1879. Publication date-1989.

Pg. 76, Sandboxes; The Little Tikes Company, 2180 Barlow Rd., Hudson, OH 44236. Publication date-1991.

Primary Examiner—Prabhakar G. Deshmukh

Attorney, Agent, or Firm—Richard B. O'Planick; Lisa B. Riedesel

[57] CLAIM

The ornamental design for a sandbox, as shown and described.

[56] References Cited

U.S. PATENT DOCUMENTS

| | | | |
|------------|---------|-------------------|---------|
| D. 160,499 | 10/1950 | Hughes . | |
| D. 189,199 | 11/1960 | Allen et al. . | |
| D. 204,287 | 4/1966 | Thompson . | |
| D. 262,563 | 1/1982 | Reiling et al. . | |
| D. 273,508 | 4/1984 | Mariol | D21/252 |
| D. 280,436 | 9/1985 | Mariol . | |
| D. 308,088 | 5/1990 | Mariol . | |
| D. 311,432 | 10/1990 | Cattoni | D21/252 |
| D. 313,058 | 12/1990 | Wehmeyer | D21/252 |
| D. 334,789 | 4/1993 | Fish . | |
| D. 337,136 | 7/1993 | Murdough et al. . | |
| 3,126,669 | 3/1964 | Gausewutz . | |
| 4,515,360 | 5/1985 | Mariol . | |
| 4,799,665 | 1/1989 | Bracy | 472/126 |
| 4,894,041 | 1/1990 | Dahlgren . | |
| 5,205,791 | 4/1993 | Pledger | 472/126 |

DESCRIPTION

FIG. 1 is a top right front perspective view of a sandbox showing our new design;

FIG. 2 is a top plan view thereof, in a reduced scale;

FIG. 3 is a bottom plan view thereof, in reduced scale;

FIG. 4 is a front elevational view thereof;

FIG. 5 is a rear elevational view thereof;

FIG. 6 is a side elevational view thereof; the opposite side being a mirror image;

FIG. 7 is a top right front perspective view of the base of the sandbox shown with the lid removed;

FIG. 8 is a right side elevational view of the sandbox base; the opposite side being a mirror image;

FIG. 9 is a rear elevational view of the sandbox base; and,

FIG. 10 is a top plan view of the sandbox base, in reduced scale.

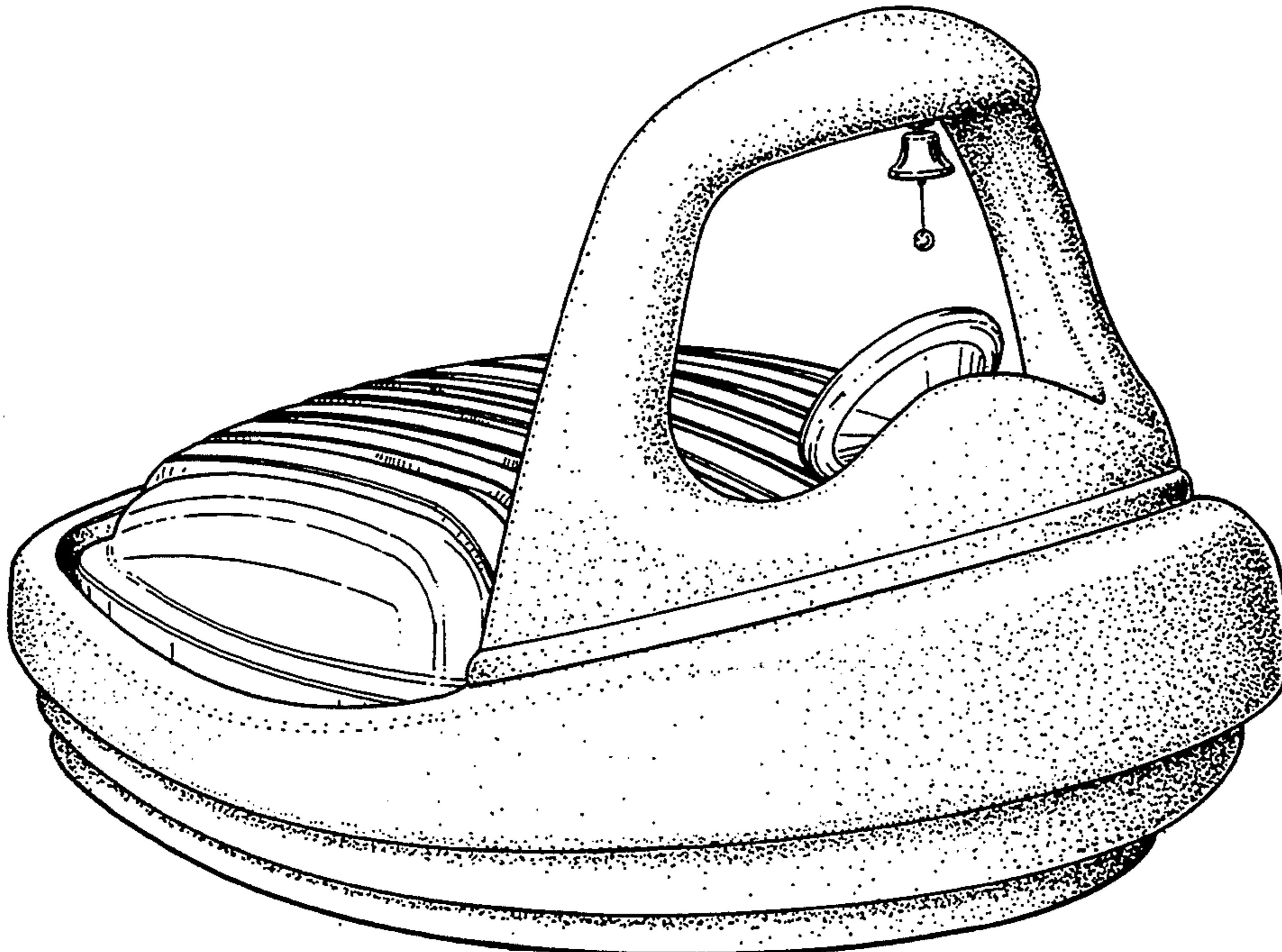

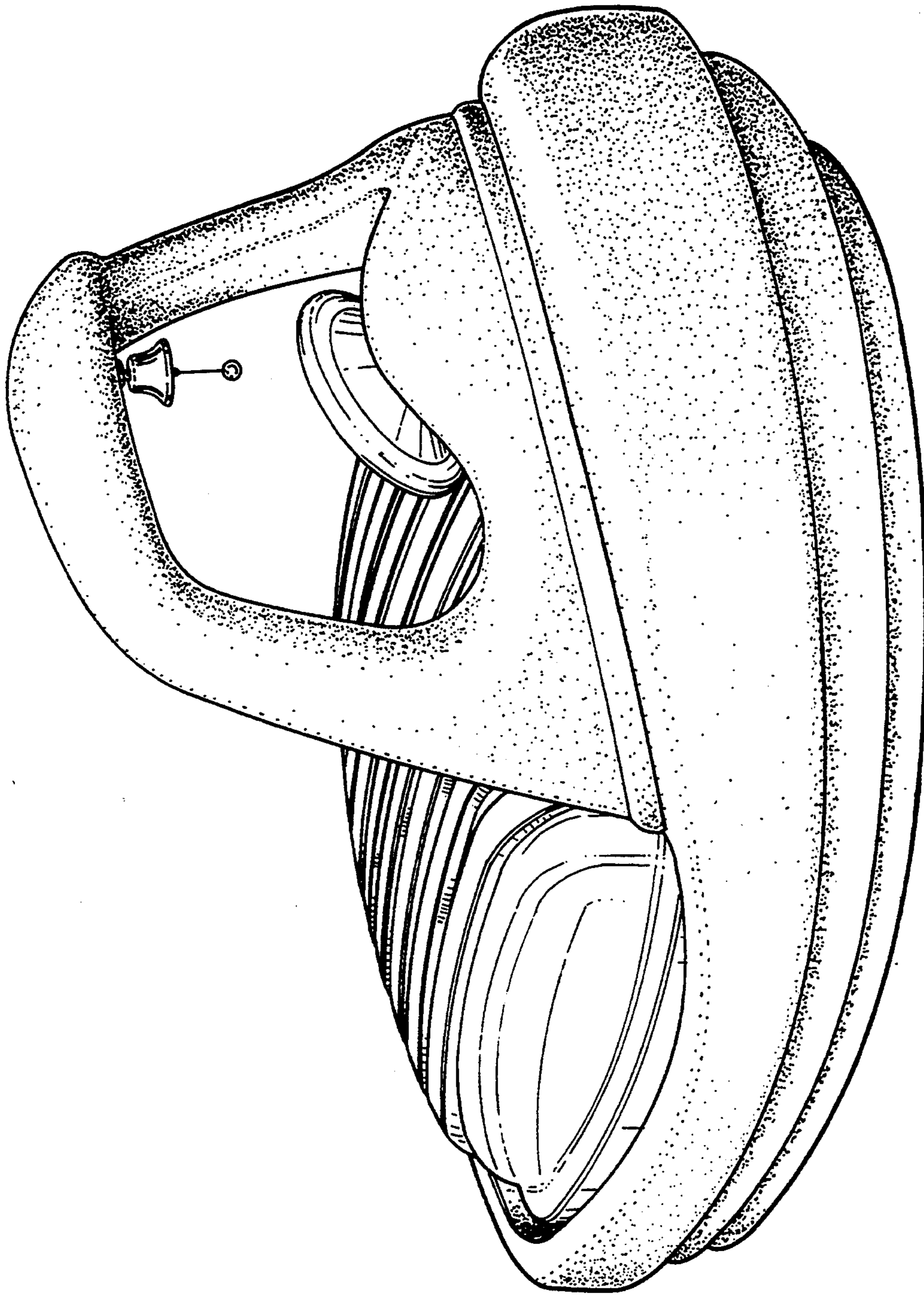

FIG. 1

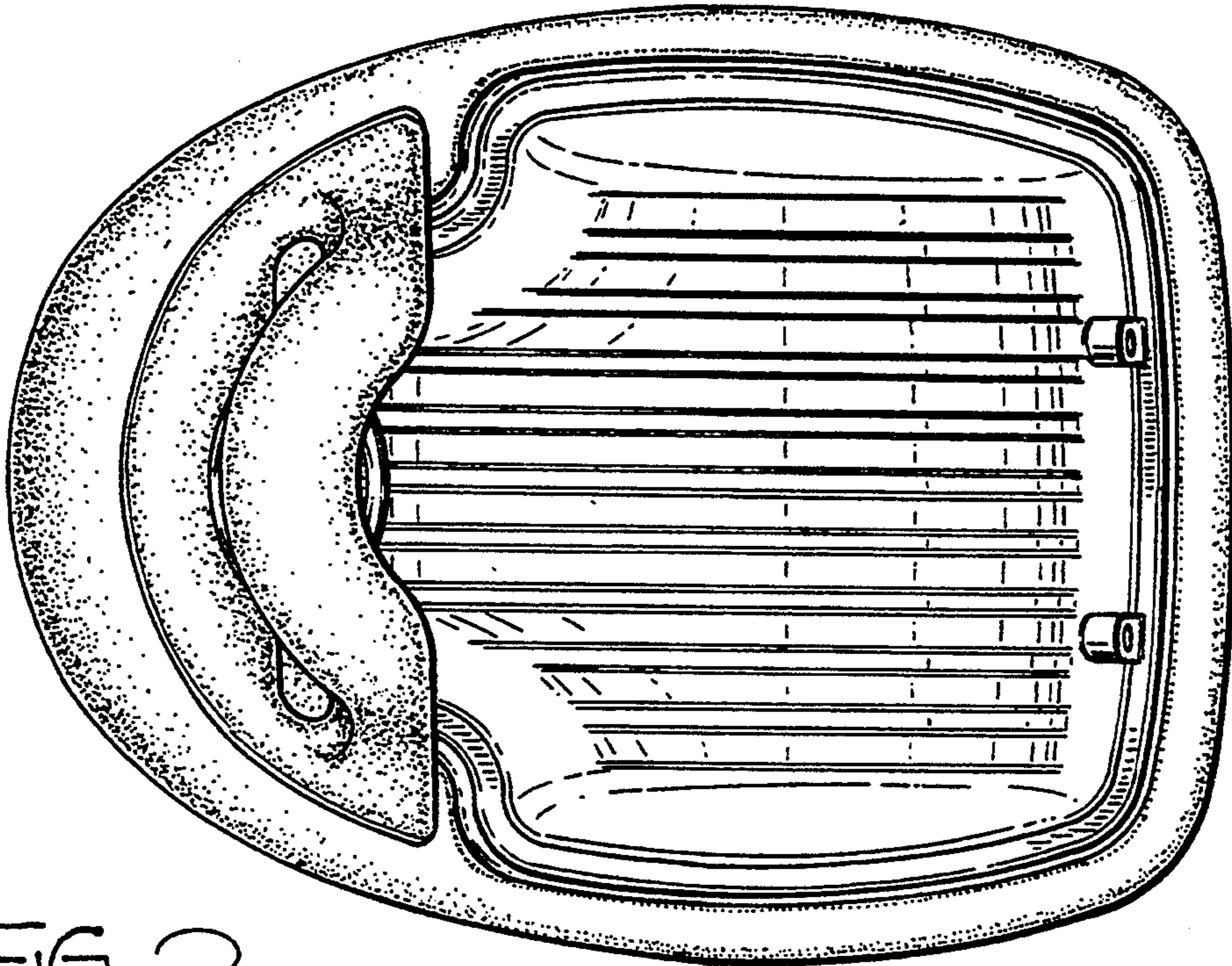

FIG. 2

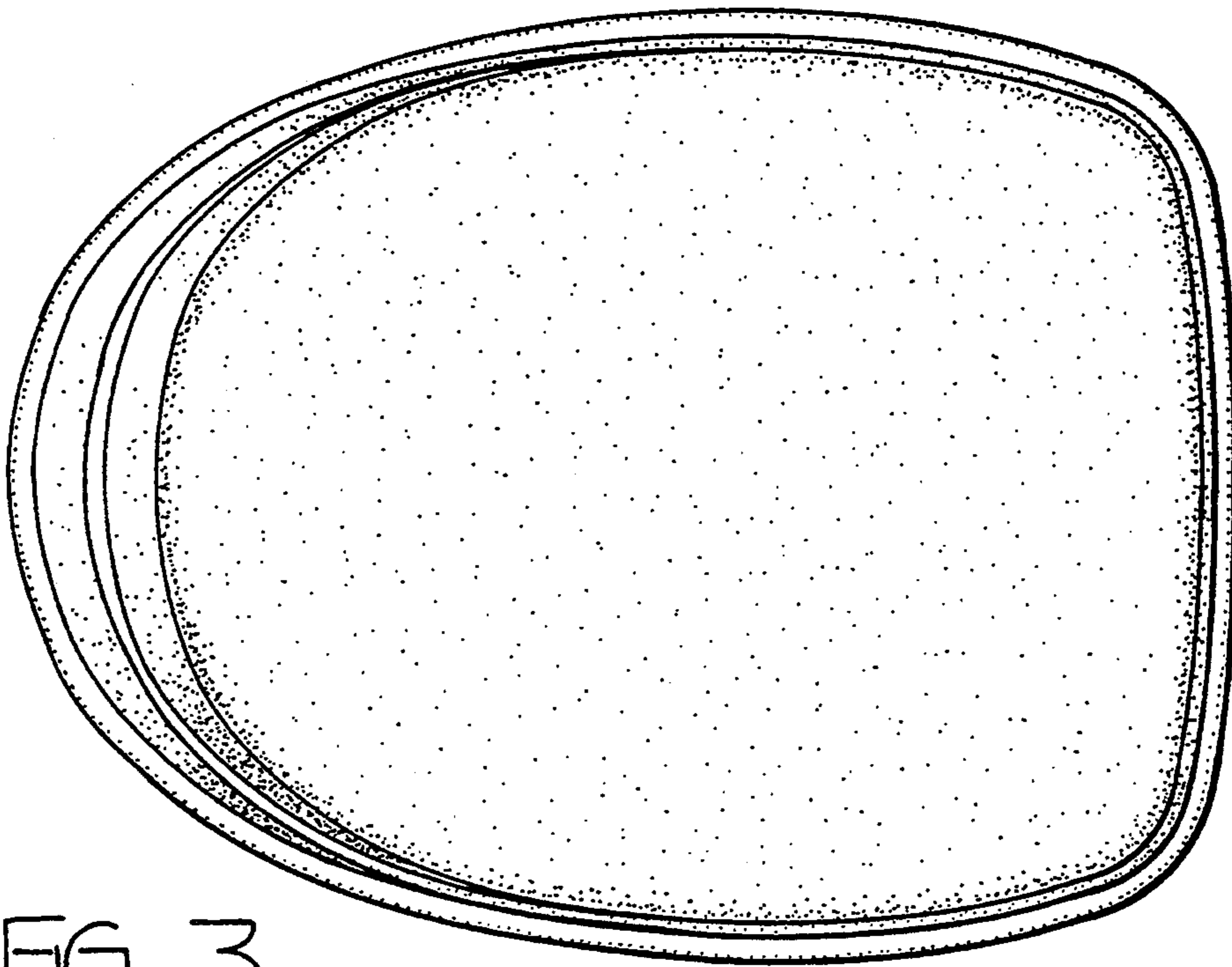

FIG. 3

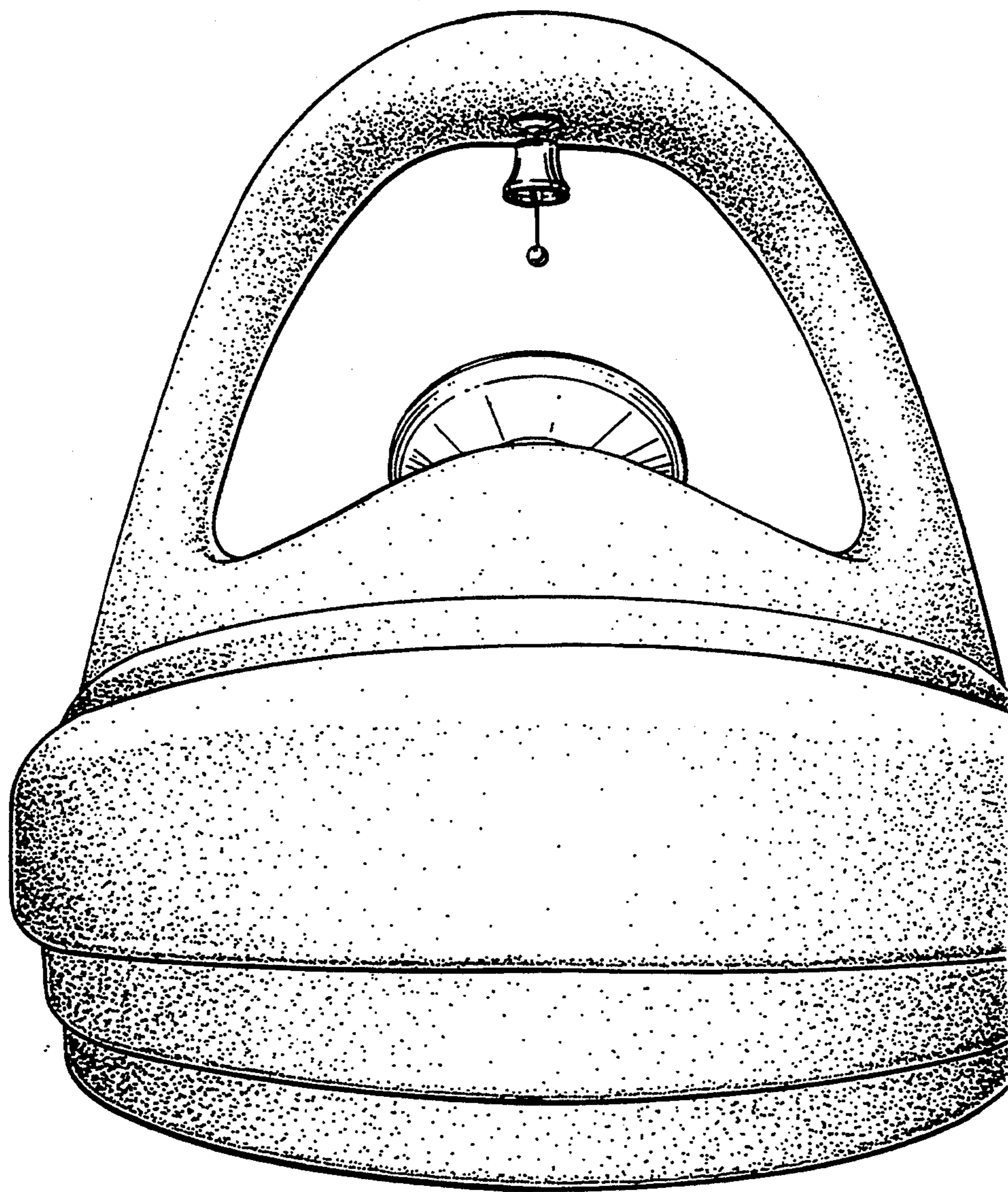

FIG. 4

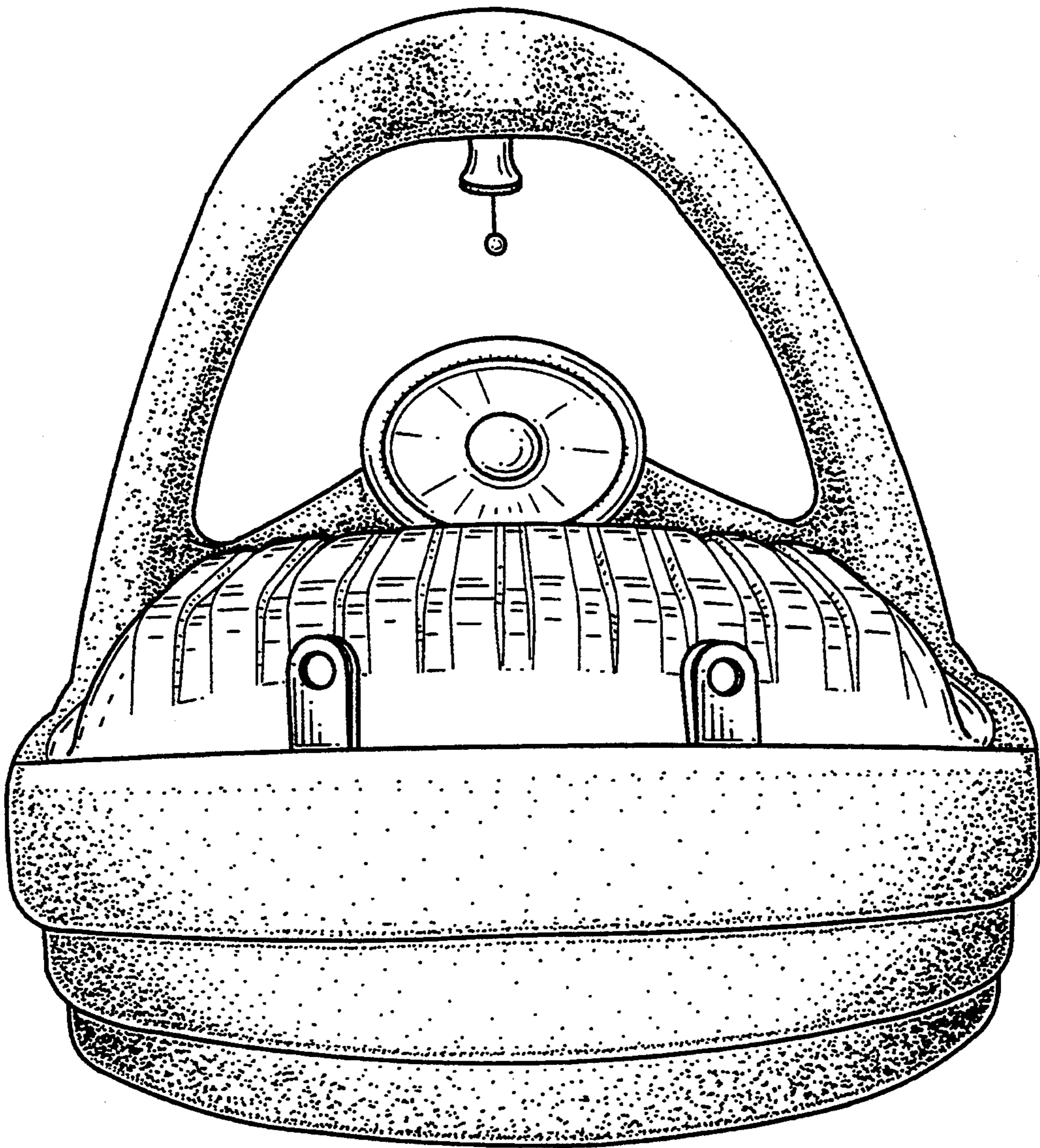

FIG. 5

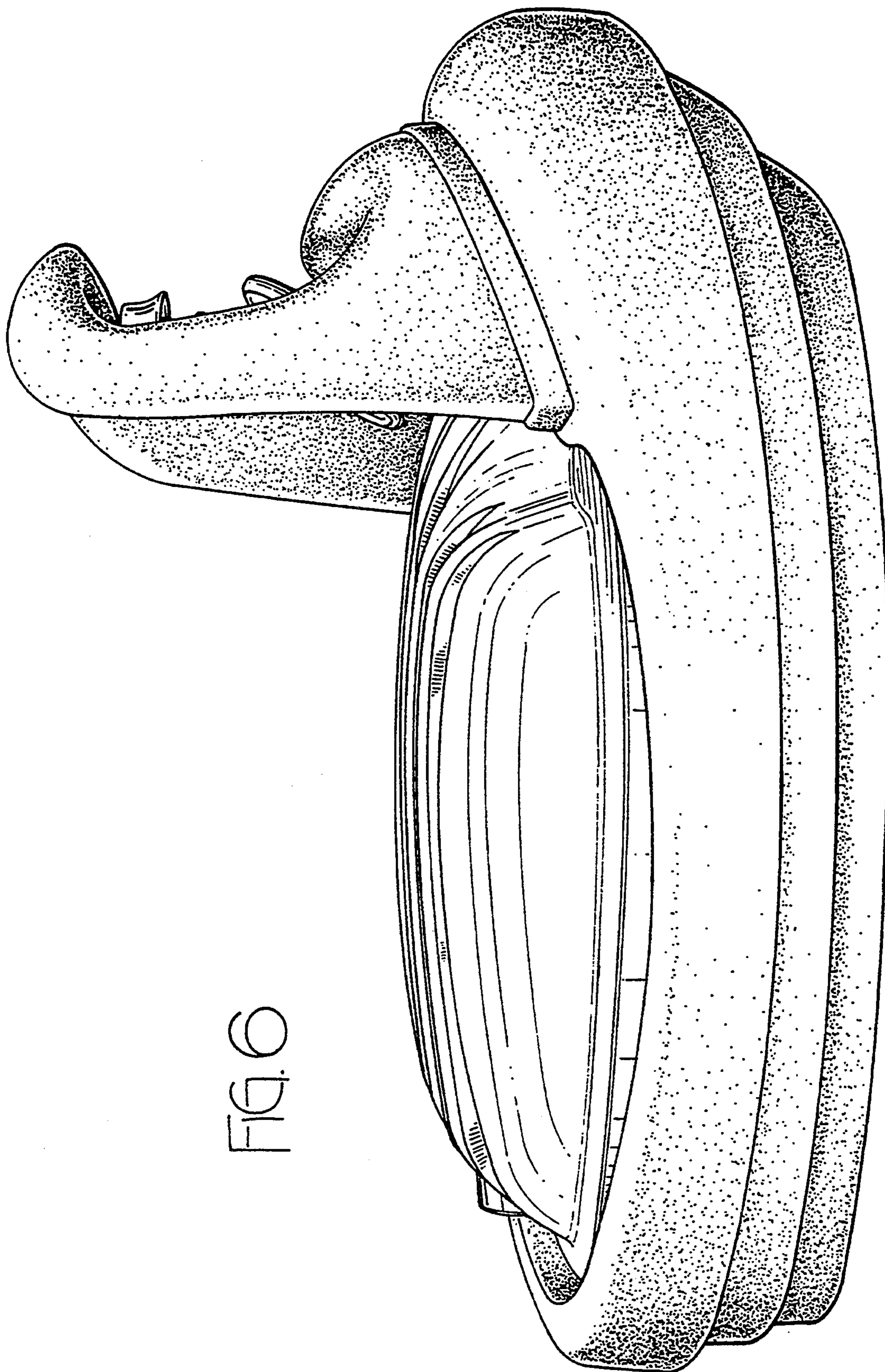

FIG. 6

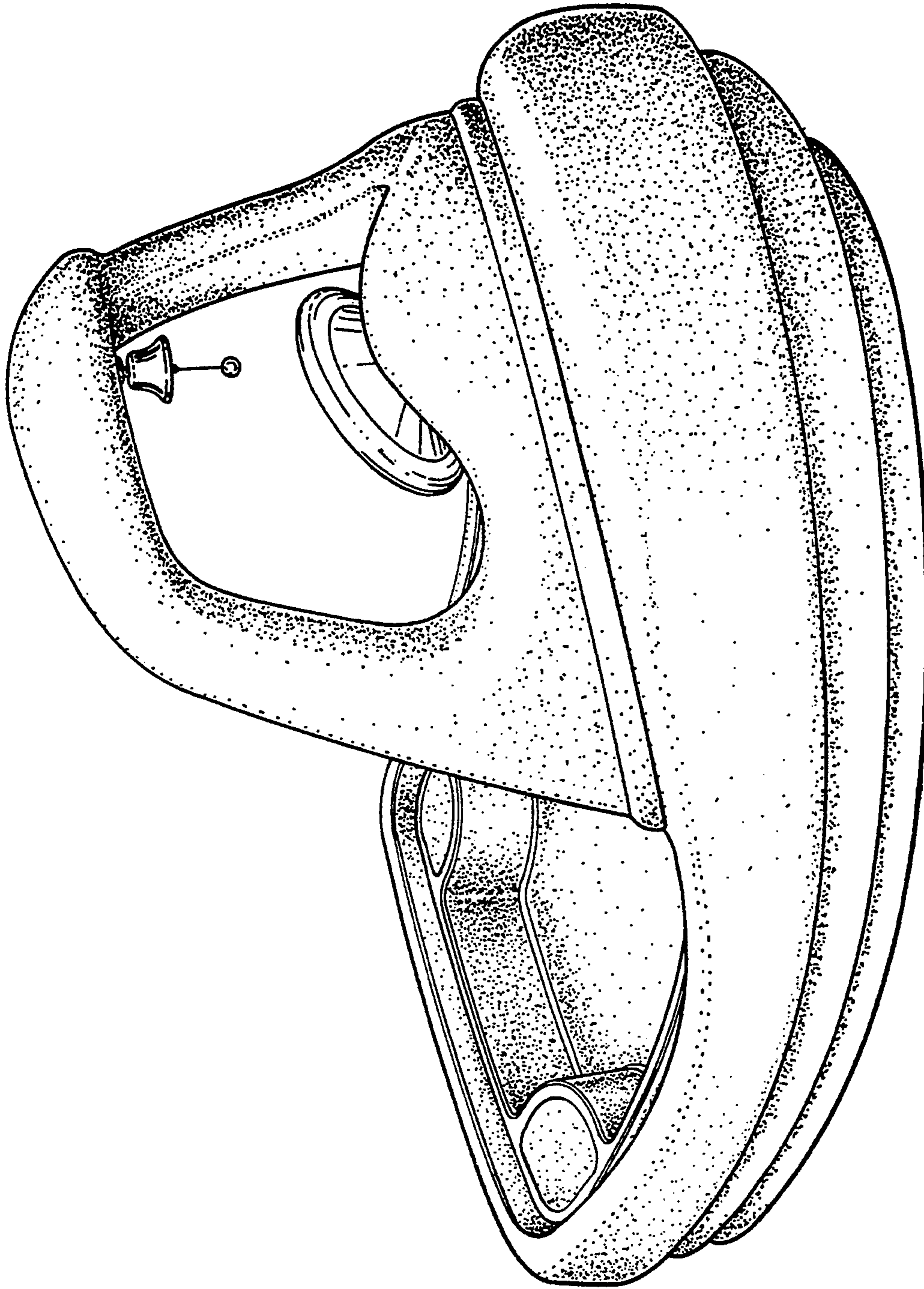

FIG. 7

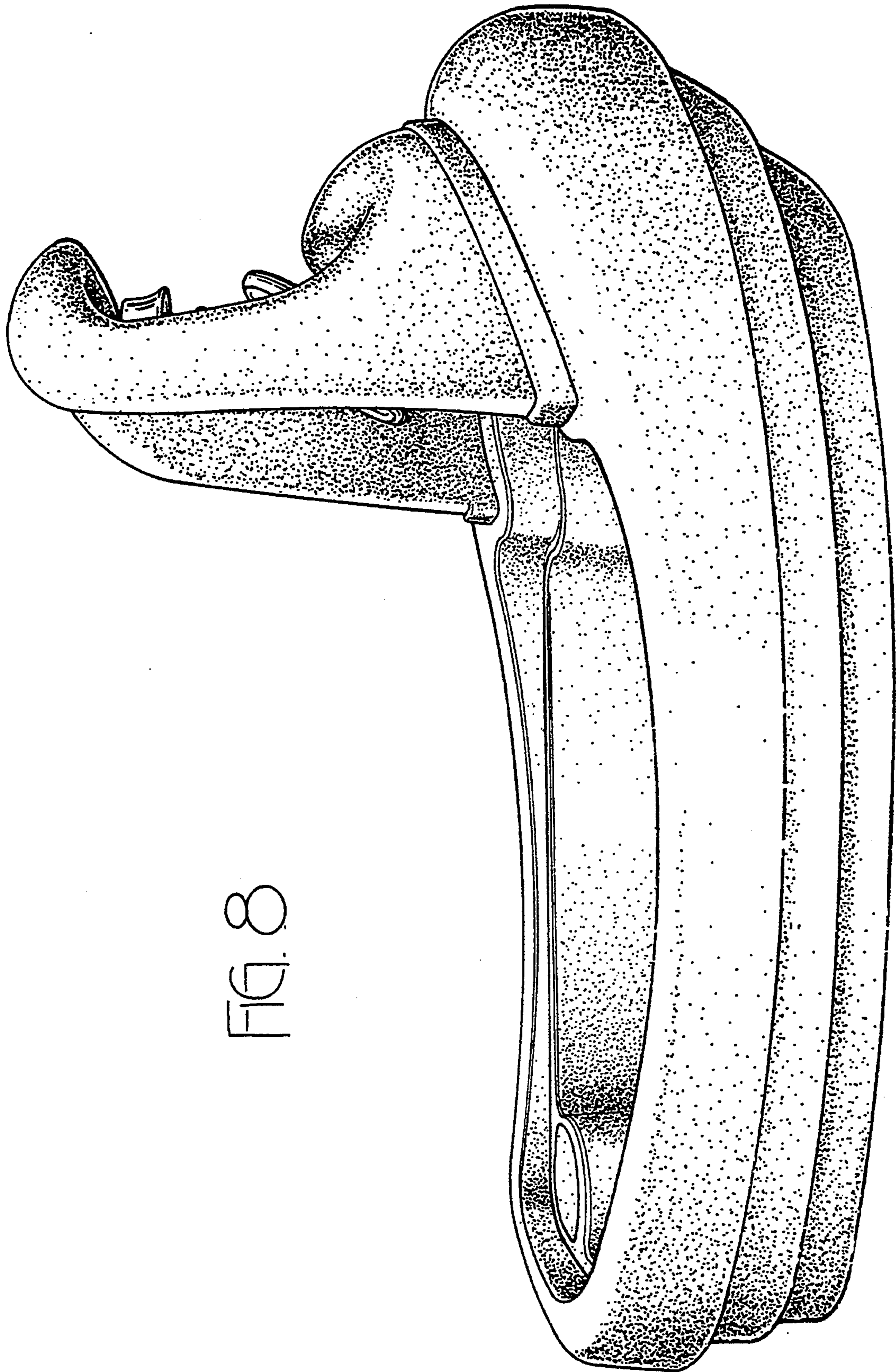

FIG. 8

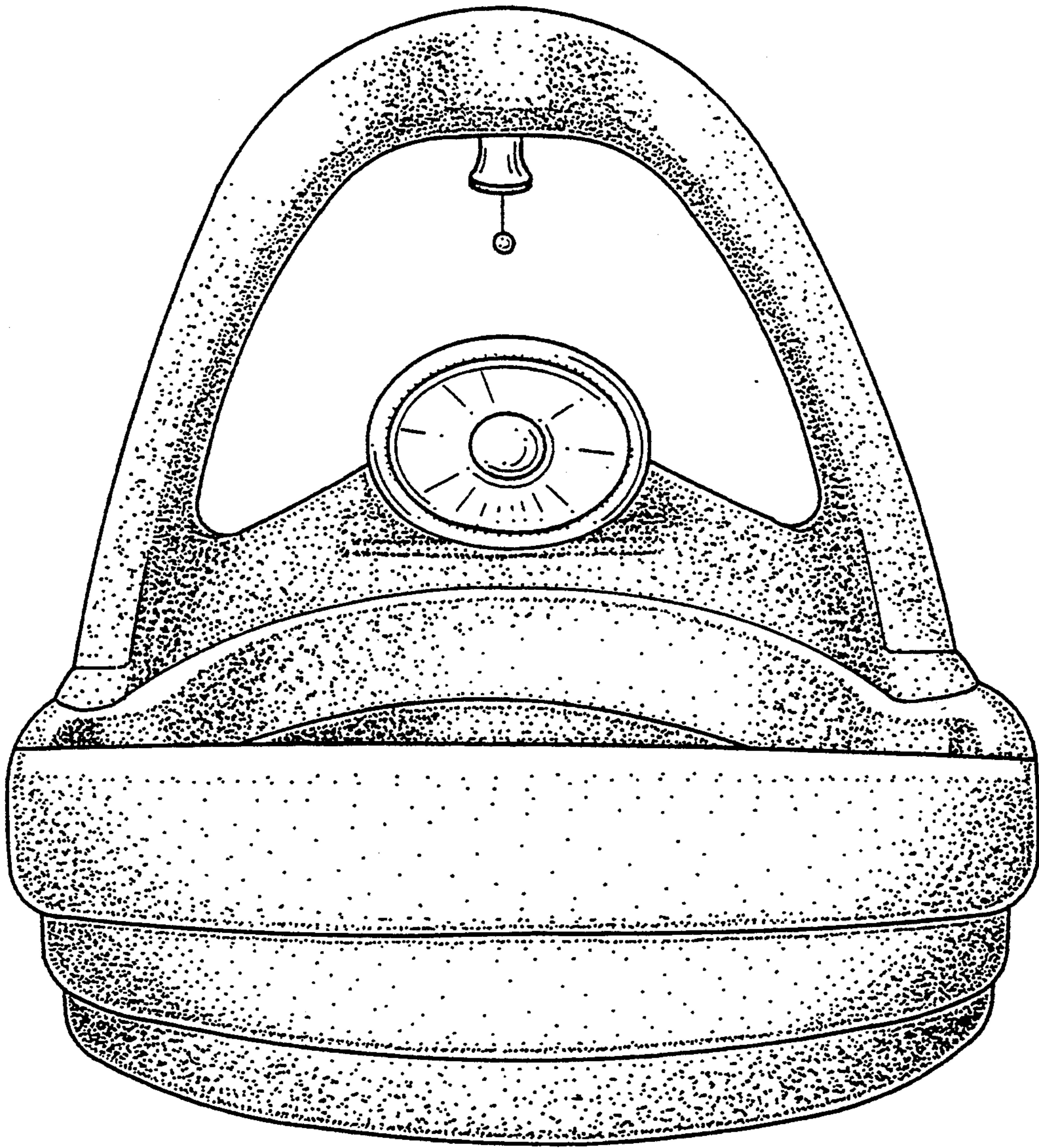

FIG. 9

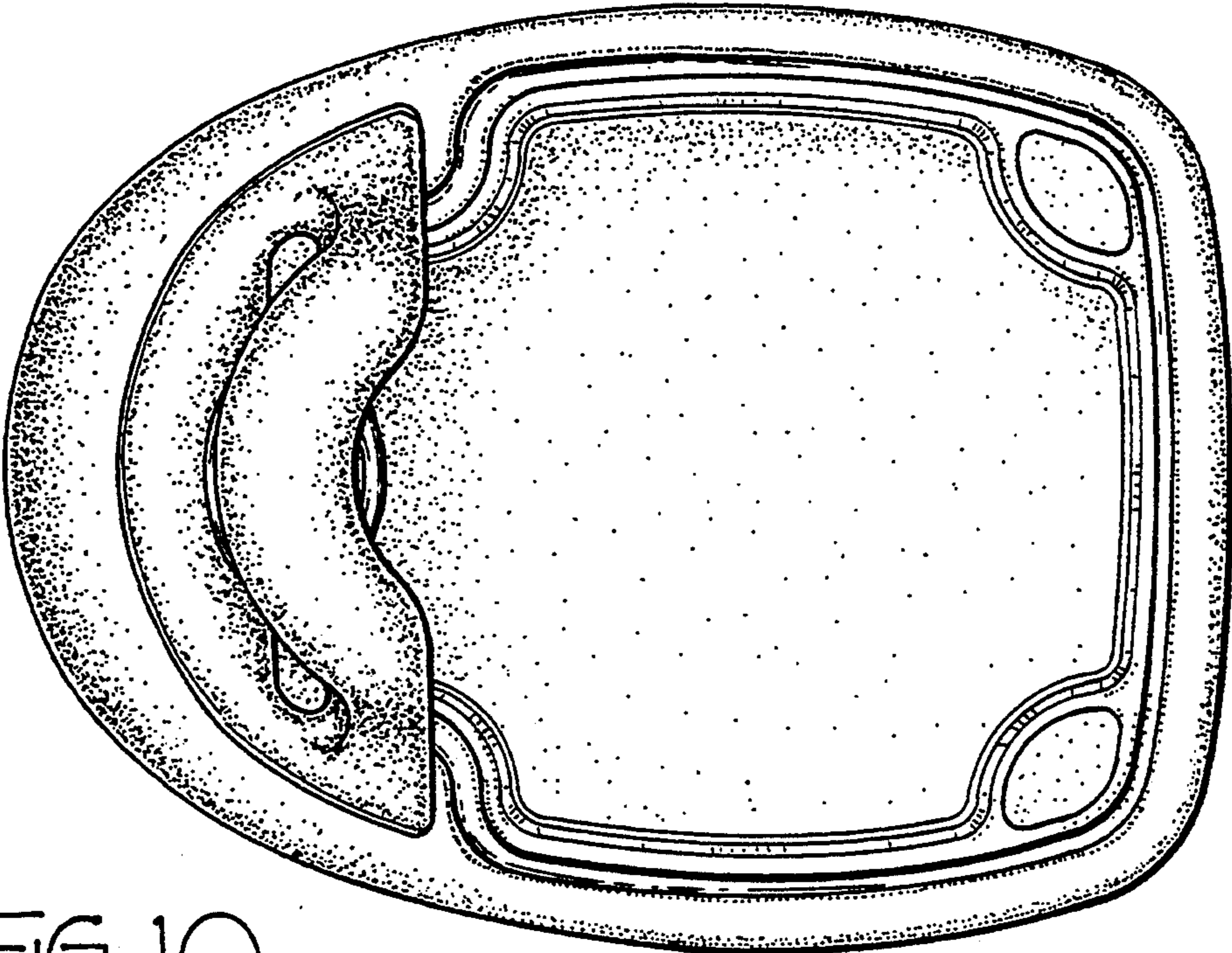

FIG. 10