



US00D352954S

# United States Patent [19]

Seshimo et al.

[11] Patent Number: **Des. 352,954**

[45] Date of Patent: **\*\* Nov. 29, 1994**

[54] **RIBBON CARTRIDGE FOR PRINTER**

[75] Inventors: **Tatsuya Seshimo; Kiyoto Komuro; Kenjiro Murakami**, all of Nagano, Japan

[73] Assignee: **Seiko Epson Corporation**, Tokyo, Japan

[\*\*] Term: **14 Years**

[21] Appl. No.: **869,708**

[22] Filed: **Apr. 17, 1992**

[30] **Foreign Application Priority Data**

Oct. 30, 1991 [JP] Japan ..... 3-32911

[52] U.S. Cl. .... **D18/12**

[58] Field of Search ..... 400/194, 195, 196, 196.1, 400/207, 208, 247; D14/121; D18/12, 22, 40, 56, 99

[56] **References Cited**

**U.S. PATENT DOCUMENTS**

D. 302,438 7/1989 Omino ..... D18/12  
D. 302,828 8/1989 Endo et al. .... D18/12

D. 304,955 12/1989 Tsukada ..... D18/12  
D. 332,796 1/1993 DeFalco et al. .... D18/12  
4,712,935 12/1987 LaDue et al. .... 400/247 X  
5,071,272 12/1991 Bell ..... 400/208  
5,141,342 8/1992 Kawahara ..... 400/207  
5,186,554 2/1993 Mizutani ..... 400/247

*Primary Examiner*—Alan P. Douglas  
*Assistant Examiner*—Robert M. Spear  
*Attorney, Agent, or Firm*—Stroock & Stroock & Lavan

[57] **CLAIM**

The ornamental design for a ribbon cartridge for printer, as shown.

**DESCRIPTION**

FIG. 1 is a perspective view of the ribbon cartridge for printer in accordance with my new design; FIG. 2 is a front elevational view thereof; FIG. 3 is a top plan view thereof; FIG. 4 is a left side view thereof; FIG. 5 is a right side view thereof; FIG. 6 is a rear elevational view thereof; FIG. 7 is a bottom plan view thereof; and, FIG. 8 is a perspective view of ribbon cartridge showing the interior of the widened ribbon shield.

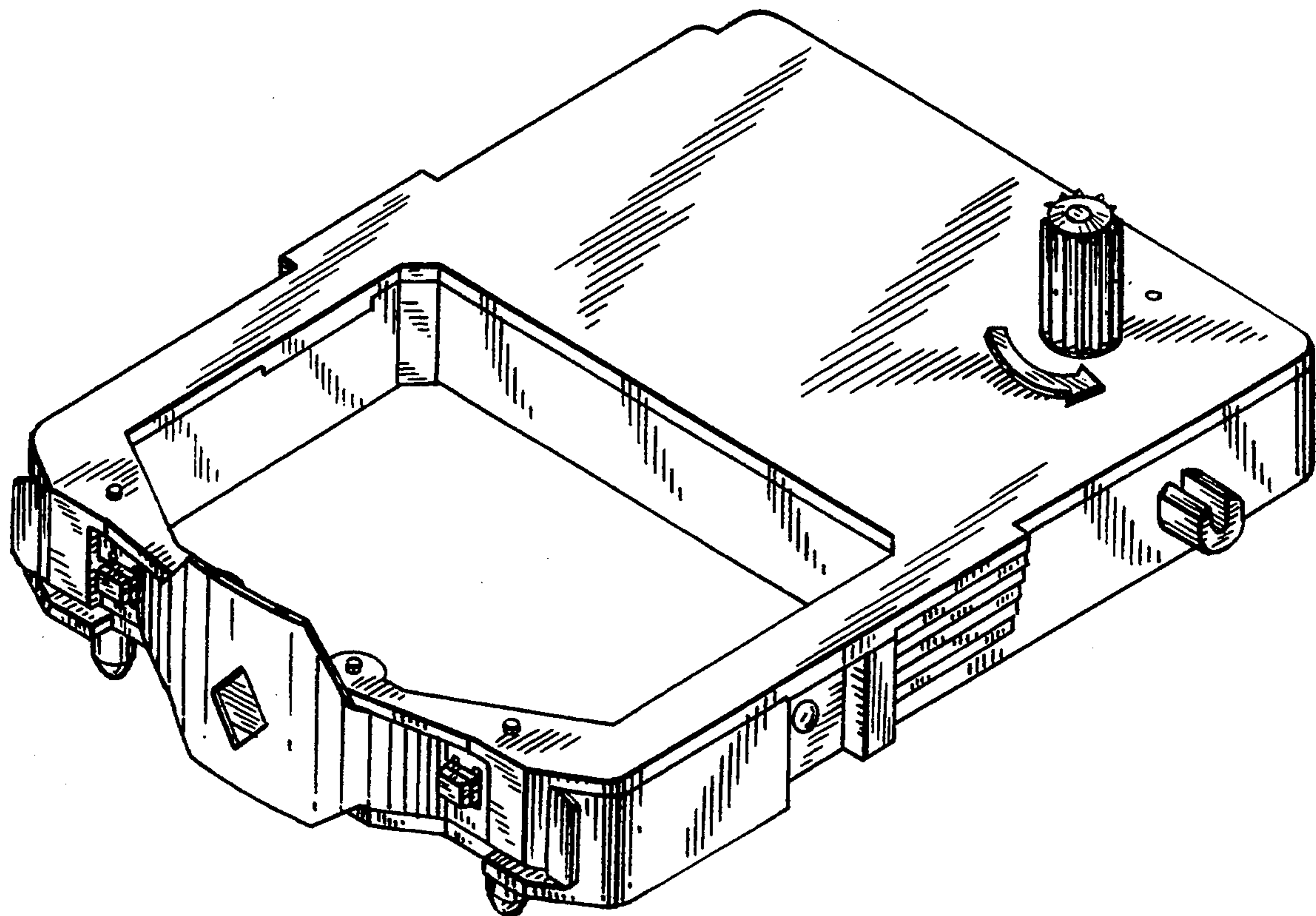

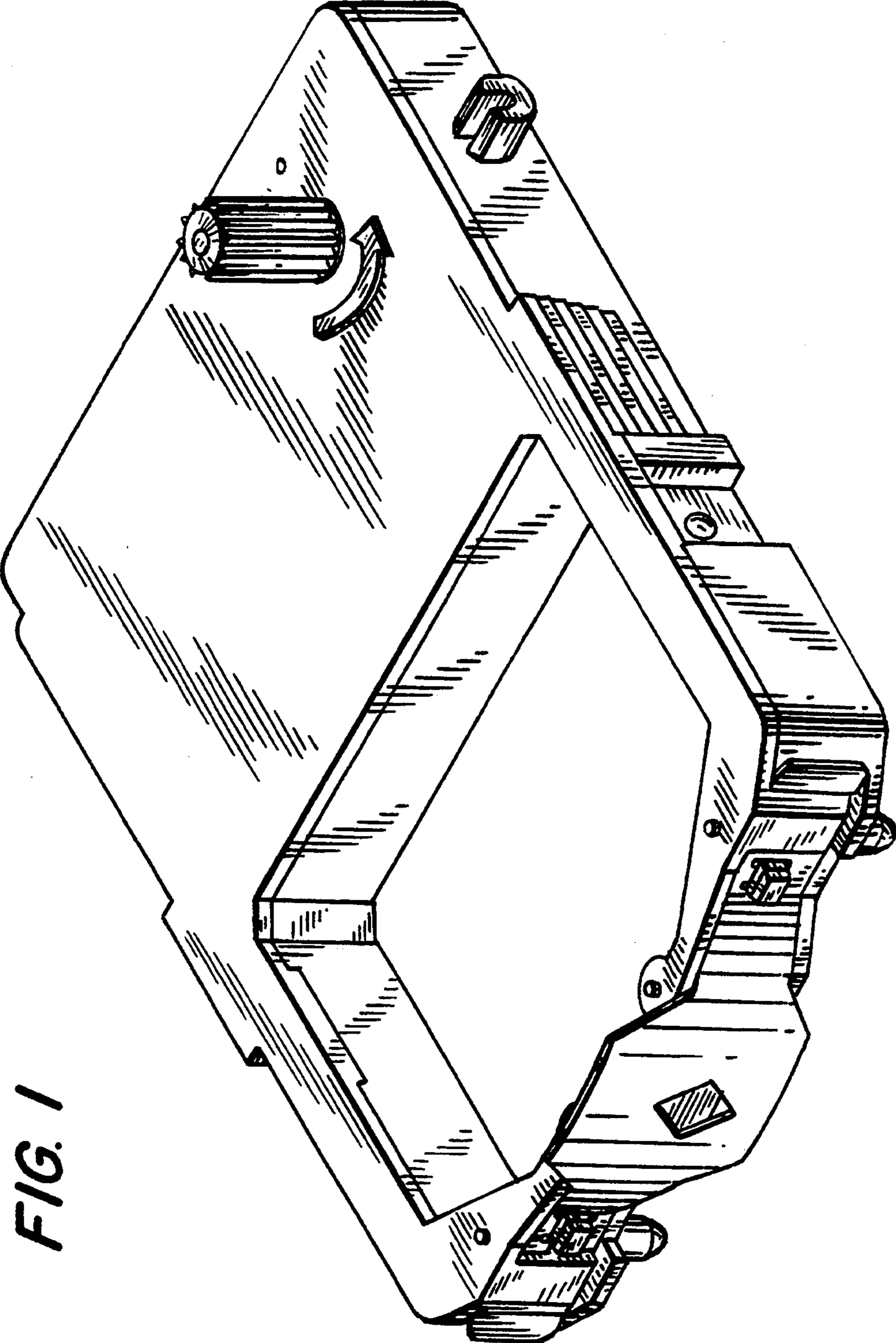
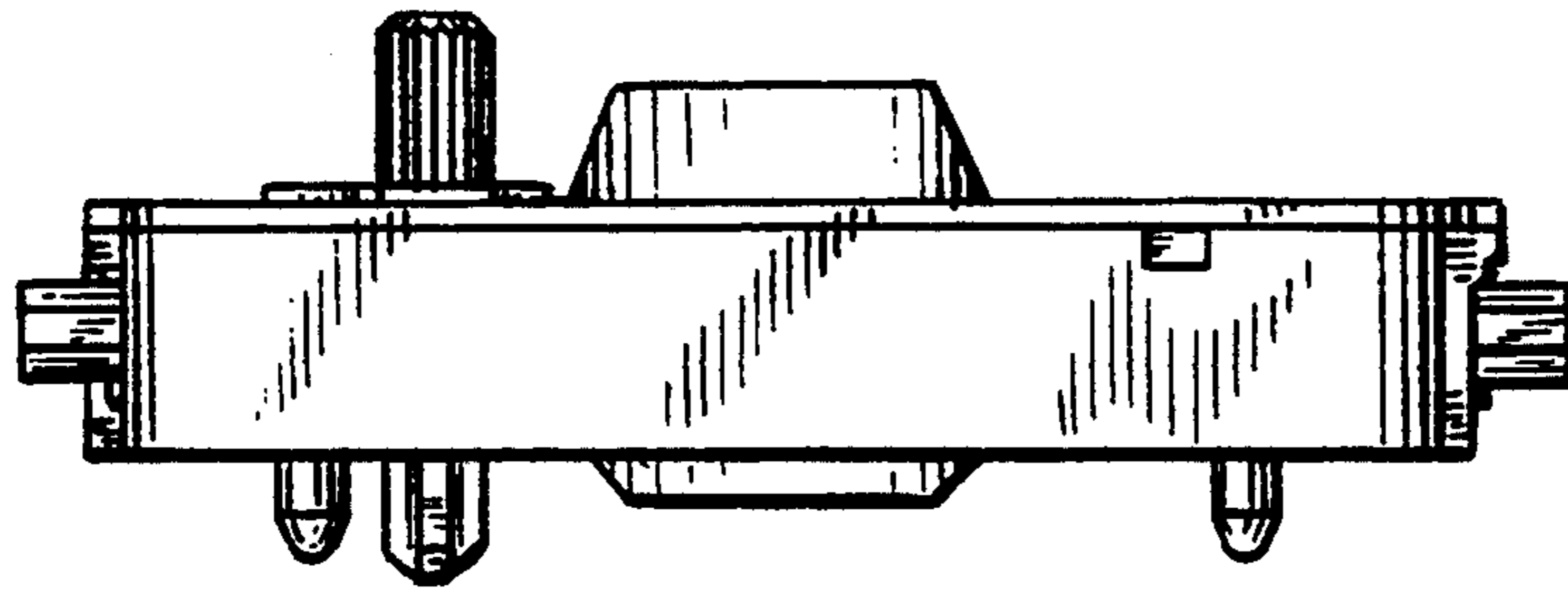
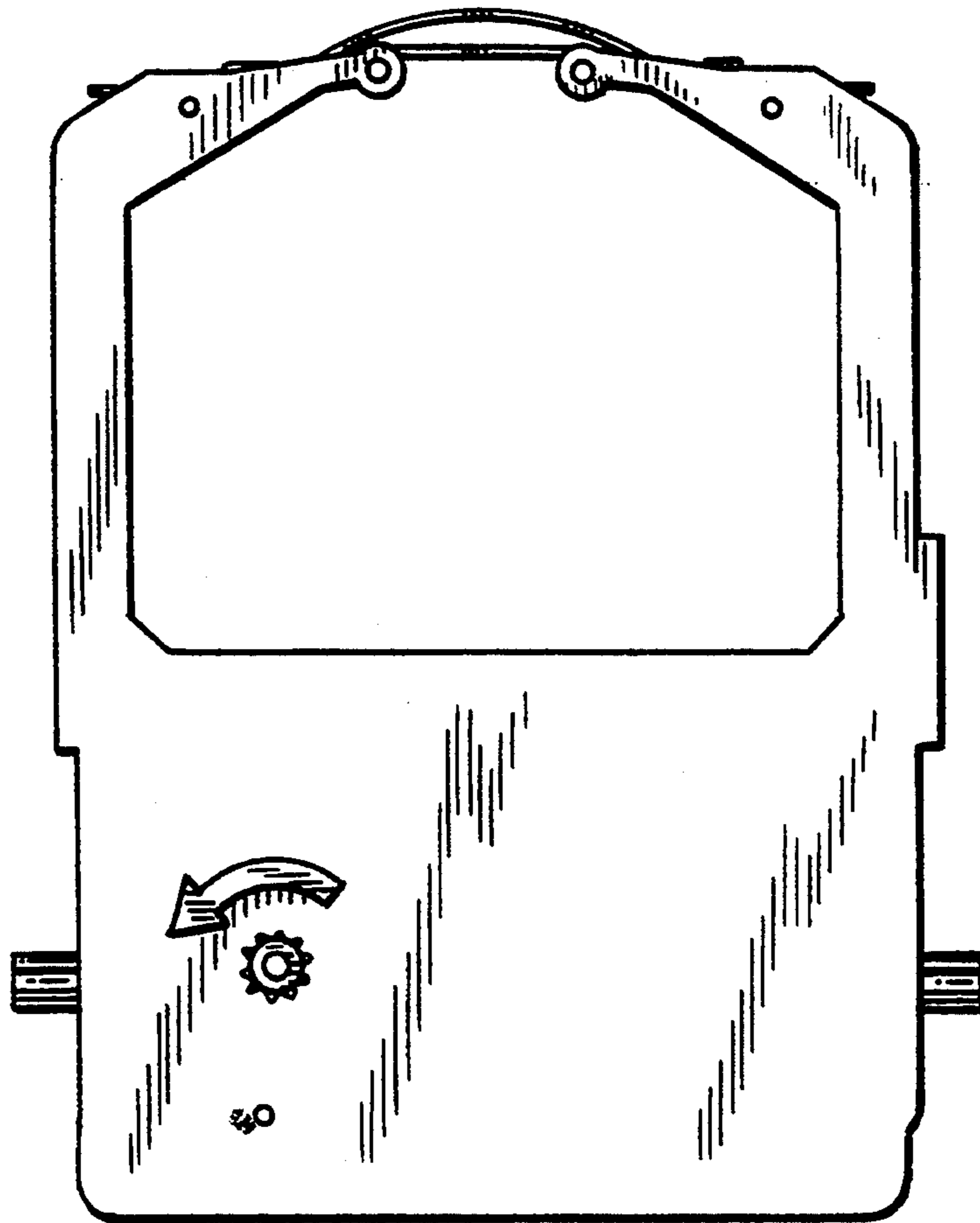

FIG. 1

*FIG. 2*



*FIG. 3*



*FIG. 4*

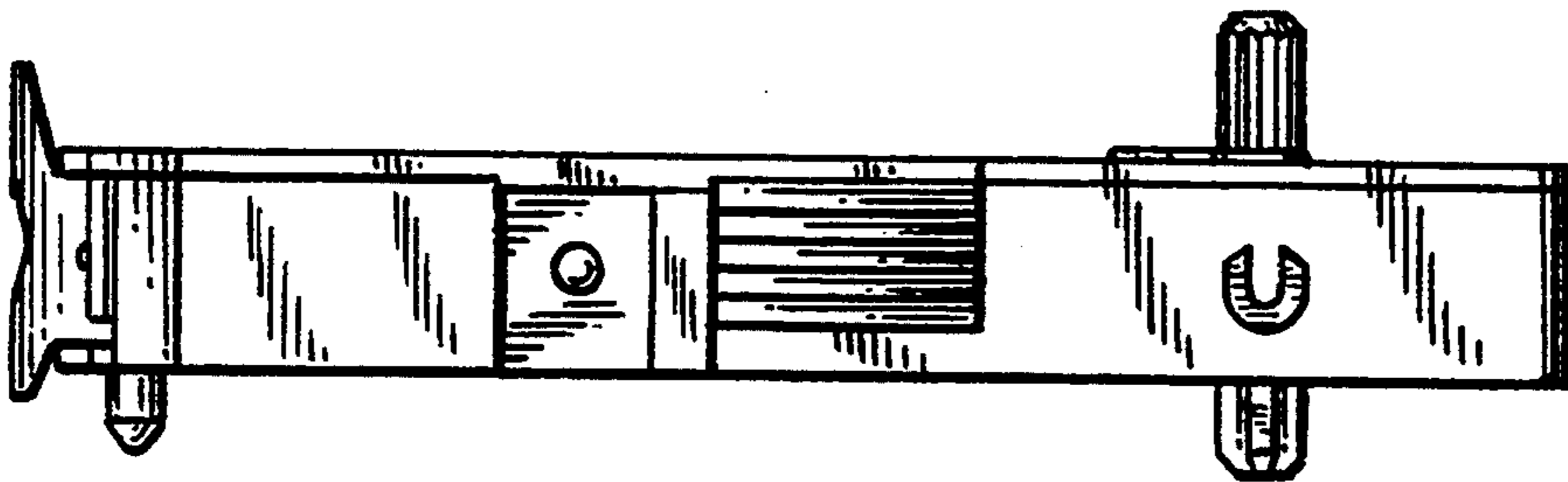

*FIG. 5*

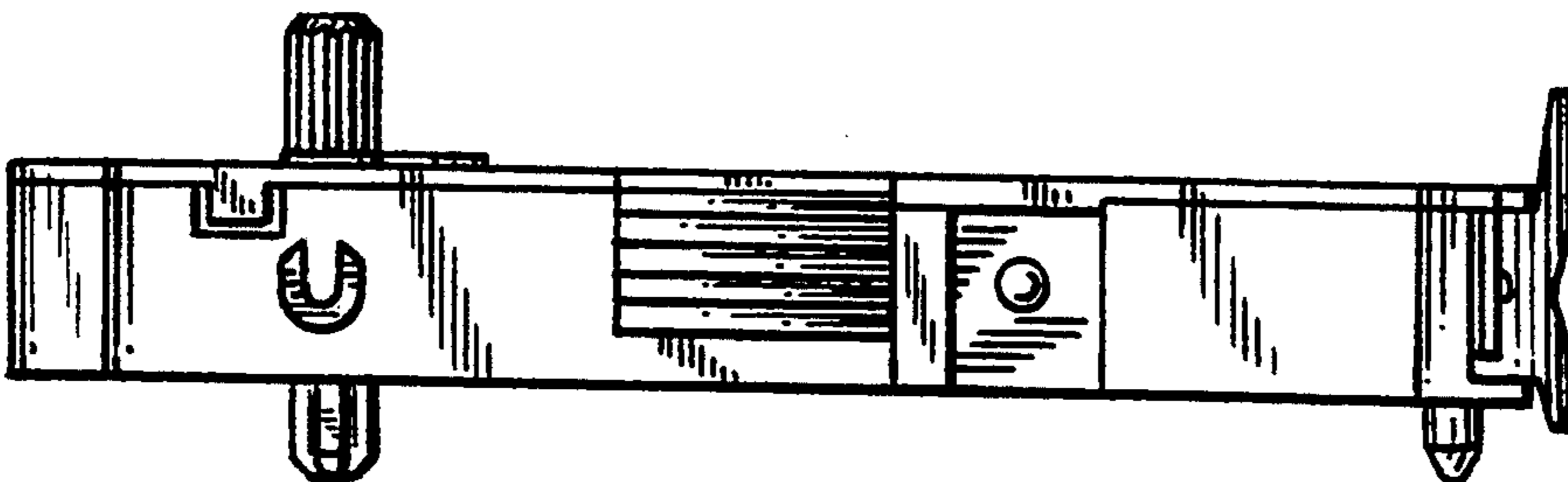

*FIG. 6*

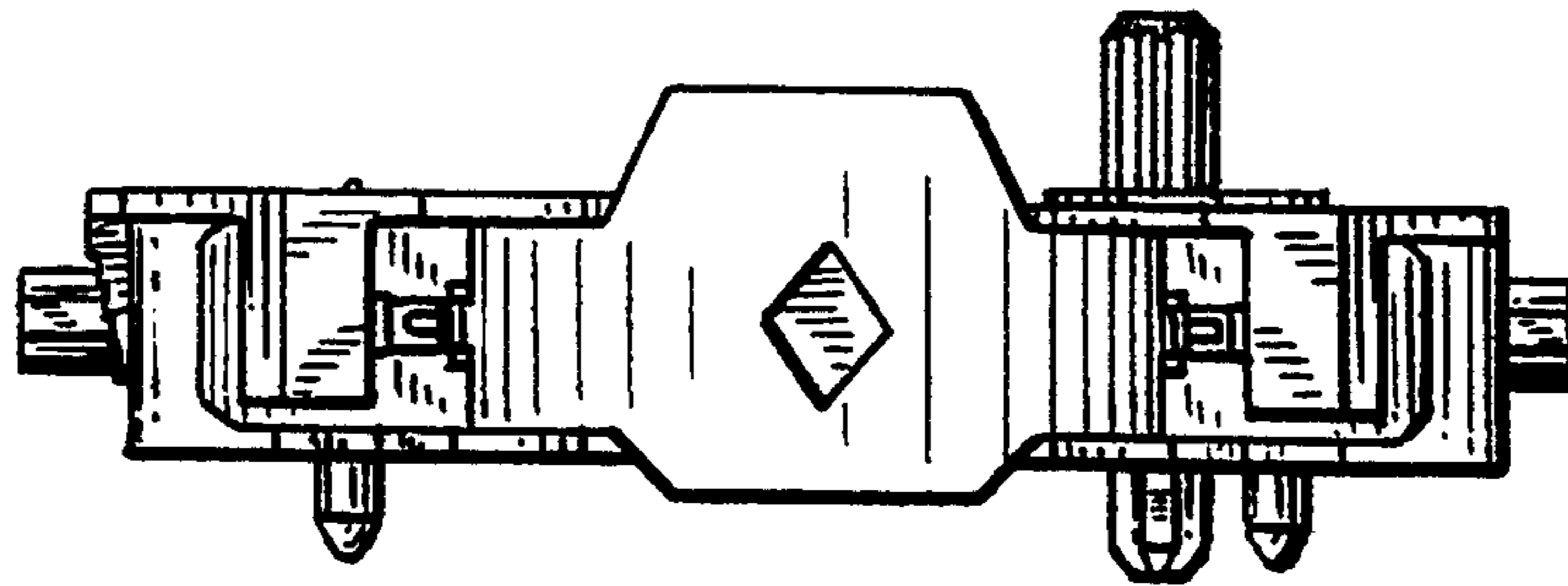

*FIG. 7*

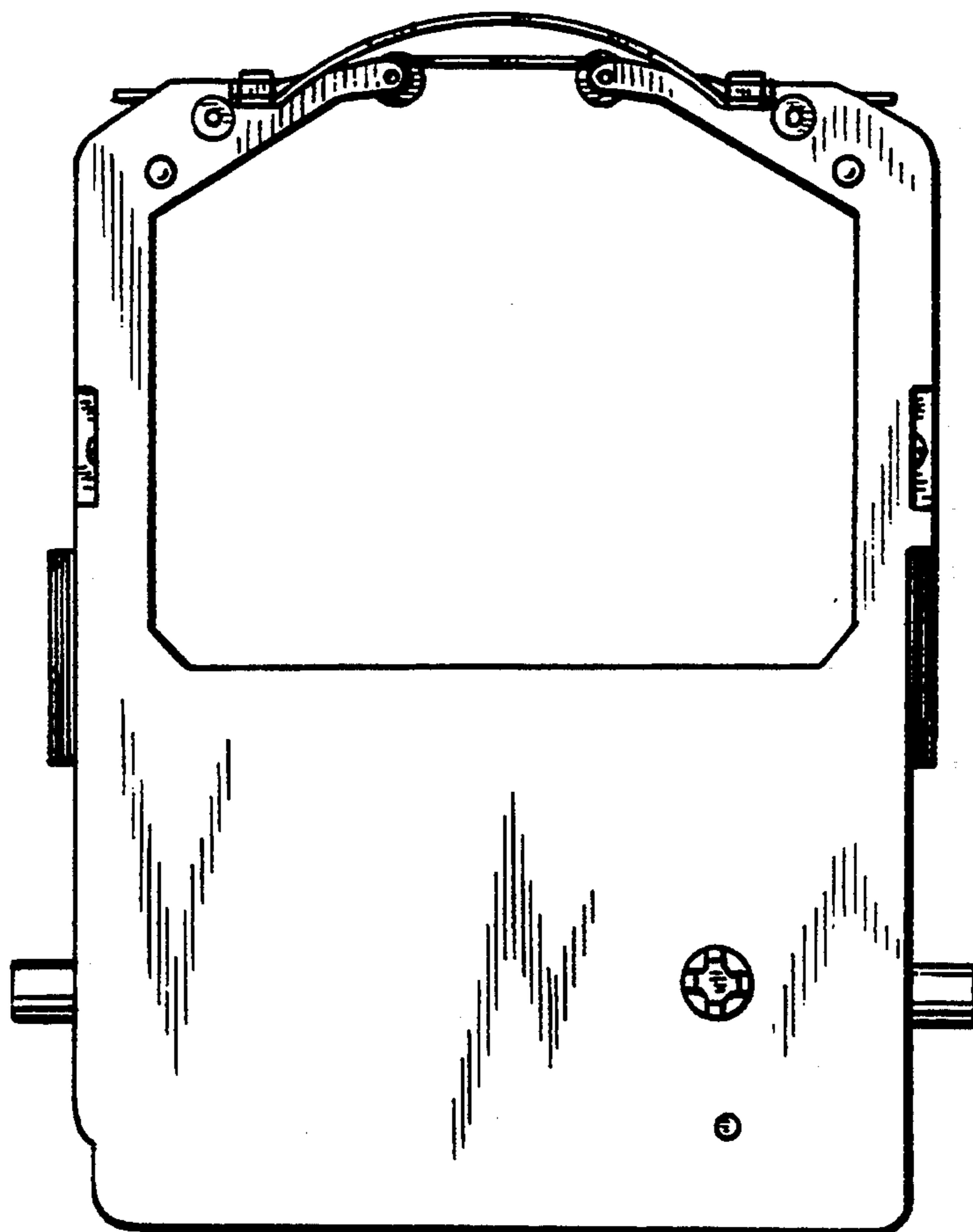

FIG. 8

