



US00D352918S

United States Patent [19]

[11] Patent Number: **Des. 352,918**

Weder et al.

[45] Date of Patent: **** Nov. 29, 1994**

[54] FLOWER POT COVER

[75] Inventors: **Donald E. Weder; Joseph G. Straeter,**
both of Highland, Ill.

Primary Examiner—Martie Thompson
Attorney, Agent, or Firm—Dunlap, Coddling & Lee

[73] Assignee: **Highland Supply Corporation,**
Highland, Ill.

[57] CLAIM

[**] Term: **14 Years**

The ornamental design for a flower pot cover, as shown and described.

[21] Appl. No.: **808,566**

[22] Filed: **Dec. 16, 1991**

DESCRIPTION

Related U.S. Application Data

[63] Continuation-in-part of Ser. No. 710,272, Jun. 4, 1991, which is a continuation-in-part of Ser. No. 617,454, Nov. 21, 1990, and a continuation-in-part of Ser. No. 411,249, Sep. 22, 1989, and a continuation-in-part of Ser. No. 411,247, Sep. 22, 1989, and a continuation-in-part of Ser. No. 411,245, Sep. 22, 1989.

[52] U.S. Cl. **D11/164**

[58] Field of Search 47/66, 72; 206/423; 215/100.5; 229/1.5 B, 4.5, 922; 248/27, 835.1, 542.6; D11/143, 152, 153, 154, 155, 156, 164

FIG. 1 is a perspective view of a flower pot cover showing our new design;
FIG. 2 is a reduced side elevational view thereof;
FIG. 3 is a reduced top plan view thereof;
FIG. 4 is a reduced bottom plan view thereof;
FIG. 5 is a reduced side elevational view of the design of FIG. 1, the only difference being the angle of the skirt;
FIG. 6 is a reduced side elevational view of the design of FIG. 1, the only difference being the angle of the skirt;
FIG. 7 is a reduced side elevational of a second embodiment of the design of FIG. 1;
FIG. [is a reduced side elevational view of a third embodiment of the design of FIG. 1;
FIG. 9 is a reduced side elevational view of a fourth embodiment of the design of FIG. 1;
FIG. 10 is a reduced side elevational view of a fifth embodiment of the design of FIG. 1;
FIG. 11 is a perspective view of a sixth embodiment of the design of FIG. 1;
FIG. 12 is a reduced side elevational view thereof;
FIG. 13 is a reduced top plan view thereof;
FIG. 14 is a reduced bottom plan view thereof;
FIG. 15 is a reduced side elevational view of the design of FIG. 11, the only difference being the angle of the skirt;
FIG. 16 is a reduced side elevational view of the design of FIG. 11, the only difference being the angle of the skirt;
FIG. 17 is a reduced side elevational view of a seventh embodiment of the design of FIG. 1;
FIG. 18 is a reduced side elevational view of an eighth embodiment of the design of FIG. 1;
FIG. 19 is a reduced side elevational view of a ninth embodiment of the design of FIG. 1; and,
FIG. 20 is a reduced side elevational view of a tenth embodiment of the design of FIG. 1.

[56] References Cited

U.S. PATENT DOCUMENTS

- D. 47,800 9/1915 Pick .
- 132,559 5/1942 Sawyer D11/153
- D. 209,788 11/1978 Affel .
- D. 254,659 4/1980 Karotseris D11/143
- D. 287,950 1/1987 Weder et al. D11/143
- D. 289,024 3/1987 Vaughn D11/164
- D. 289,982 5/1987 Weder et al. D11/164
- D. 292,182 10/1987 Weder et al. D11/164
- D. 292,183 10/1987 Weder et al. D11/164
- D. 292,184 10/1987 Weder et al. D11/164
- D. 292,185 10/1987 Weder et al. D11/164
- D. 292,186 10/1987 Weder et al. D11/164
- D. 292,187 10/1987 Weder et al. D11/164

(List continued on next page.)

FOREIGN PATENT DOCUMENTS

- 103316 3/1988 Australia 229/922
- 560532 4/1975 Switzerland .

OTHER PUBLICATIONS

Exhibit A. Curtis Wagner Co., Inc., Houston, Tex., shows thick, stiff shiny red plastic pot cover with large scalloped border. (Photograph) Date unknown.

(List continued on next page.)

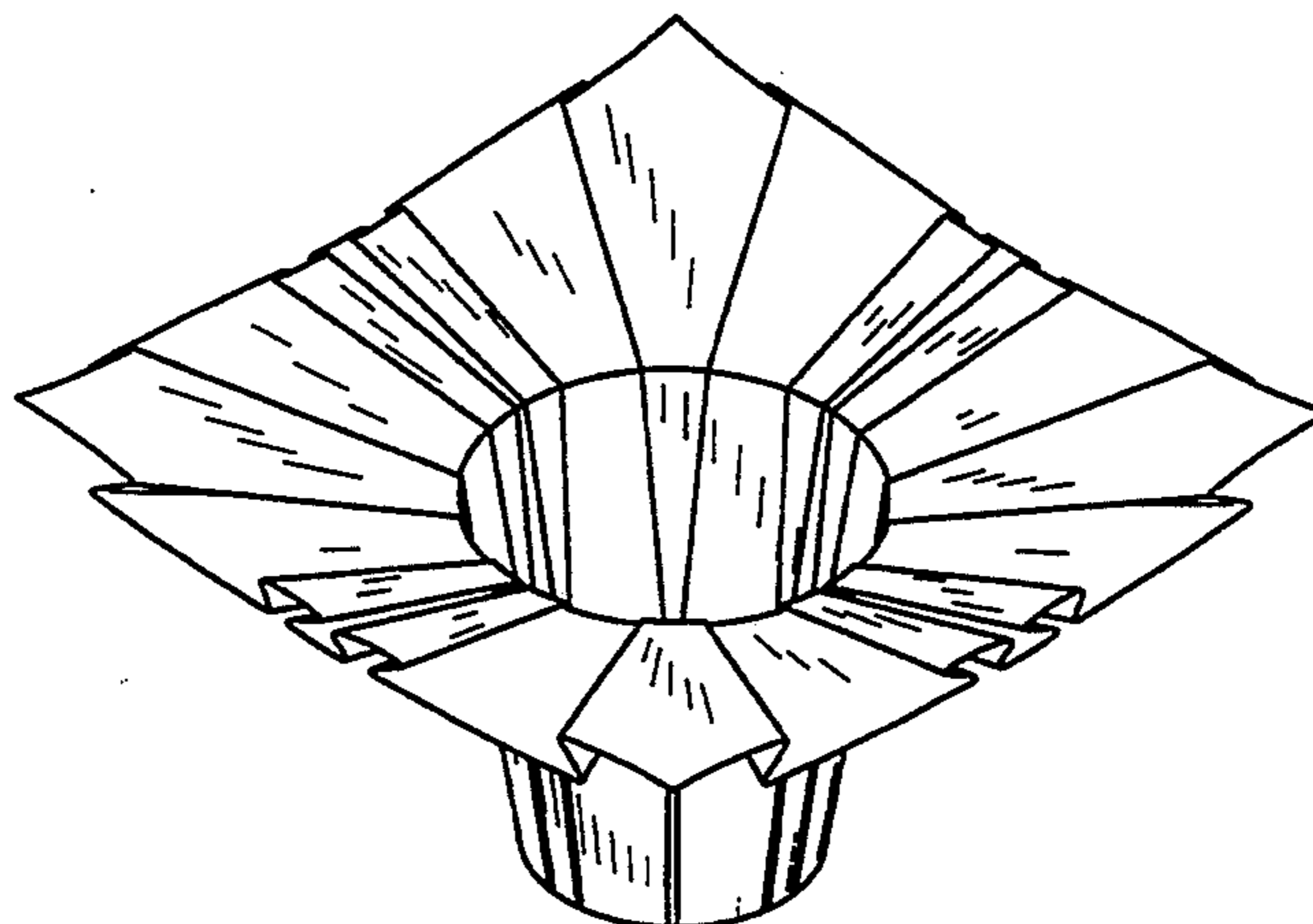

U.S. PATENT DOCUMENTS

D. 292,188	10/1987	Weber et al.	D11/164
D. 292,189	10/1987	Weder et al.	D11/164
D. 292,190	10/1987	Weder et al.	D11/164
D. 292,191	10/1987	Weder et al.	D11/164
D. 292,561	11/1987	Weder et al.	D11/164
D. 292,562	11/1987	Weder et al.	D11/164
D. 292,563	11/1987	Weder et al.	D11/164
D. 293,222	12/1987	Weder et al.	D11/164
D. 293,223	12/1987	Weder et al.	D11/164
D. 293,224	12/1987	Weder et al.	D11/164
D. 293,304	12/1987	Weder et al.	D11/164
D. 293,305	12/1987	Weder et al.	D11/164
D. 293,306	12/1987	Weder et al.	D11/164
D. 293,307	12/1987	Weder et al.	D11/164
D. 293,308	12/1987	Weder et al.	D11/164
D. 293,774	1/1988	Weder et al.	D11/164
D. 293,775	1/1988	Weder et al.	D11/164
D. 296,535	7/1988	Weder et al.	D11/149
D. 297,422	8/1988	Weder et al.	D11/164
D. 298,017	10/1988	Weder et al.	D11/164
D. 301,565	6/1989	Weder	29/152
D. 302,139	7/1989	Weder	D11/153
D. 302,253	7/1989	Weder	D11/153
D. 302,254	7/1989	Weder	D11/153
D. 302,404	7/1989	Weder	D11/153
D. 302,405	7/1989	Weder	D11/155
D. 302,406	7/1989	Weder	D11/155
D. 302,407	7/1989	Weder	D11/155
D. 303,759	10/1989	Mileos	D9/306
D. 303,775	10/1989	Weder	D11/155
D. 313,376	1/1991	Weder	D11/164
D. 313,573	1/1991	Weder et al.	D11/164
D. 313,574	1/1991	Weder et al.	D11/164
D. 313,575	1/1991	Weder et al.	D11/164
D. 313,576	1/1991	Weder	D11/164
D. 314,732	2/1991	Weder	D11/164
D. 315,534	3/1991	Weder et al.	D11/164
D. 315,878	4/1991	Weder et al.	D11/164
D. 315,879	4/1991	Weder et al.	D11/164
D. 315,880	4/1991	Weder et al.	D11/164
D. 315,881	4/1991	Weder et al.	D11/164
D. 315,882	4/1991	Weder	D11/164
D. 315,883	4/1991	Weder	D11/164
D. 316,060	4/1991	Weder	D11/164
D. 316,061	4/1991	Weder	D11/164
D. 316,062	4/1991	Weder et al.	D11/164

D. 316,837	5/1991	Weder et al.	D11/164
D. 316,838	5/1991	Weder et al.	D11/164
D. 316,985	5/1991	Weder	D11/164
D. 317,424	6/1991	Weder	D11/164

(List continued on next page.)

OTHER PUBLICATIONS

- Exhibit B. Jacobson Pot Cover Company of Scranton, Pa. advertising literature. Date of first use unknown.
- Exhibit C. Photograph of pot cover, manufacturer unknown, but very similar to #C21 on Exhibit B (Jacobson literature).
- Exhibit D. Photocopy of photo of pot cover ("Platform Pot Dresser") made by John Raisen Corp., San Francisco, Calif. Date of first use unknown.
- Exhibit E. Photograph of 2-part pot cover system made by Floral Decor, subsidiary of John Henry Co., Lansing Mich.
- Exhibit F. Photo of pot cover made by a Holland Company (K.P.I.). Date of first public use believed to be late 1984.
- Exhibit G. "The Glass of Frederick Carder", copyright 1971 by P. V. Gardner, showing various styles of glass basket-like vases or containers.
- Exhibit H. "Speed Cover®" brochure, published in 1983 by Applicants, showing various pot covers for sale.
- Exhibit I. "Speed Cover®" brochure, published in 1983 by Applicants, showing various pot covers for sale.
- Exhibit J. Item published in 1936 by Gellman Bros., Minneapolis, Minn. Shows an assortment of paper hats.
- Exhibit K. Photo of various other flower pot wrappings, sold in rolls or sheets and used in the floral industry for years.
- Exhibit L. Photo of pot cover made of woven straw-like material.
- Exhibit M. Photo of basket-type pot cover used in the floral industry.
- Exhibit N. "Speed Cover®" brochure, published in 1984 by Applicants, showing various pot covers for sale.

U.S. PATENT DOCUMENTS

D. 317,582	6/1991	Weder	D11/164	2,570,954	10/1951	Kasman	65/53
D. 317,583	6/1991	Weder et al.	D11/164	2,967,652	1/1961	Canfield et al.	229/5.5
D. 318,029	7/1991	Weder	D11/164	3,022,605	2/1962	Reynolds	47/58
D. 318,030	7/1991	Weder et al.	D11/164	3,232,469	2/1966	Piazzè	215/38
D. 318,635	7/1991	Weder et al.	D11/164	3,271,922	9/1966	Wallerstein et al.	53/3
D. 319,034	8/1991	Weder et al.	D11/164	3,488,022	1/1970	Vittori	248/152
D. 319,417	8/1991	Weder et al.	D11/164	3,542,616	11/1970	Cain et al.	156/224
D. 319,991	9/1991	Weder	D11/164	3,820,684	6/1974	Harrison	206/520
1,065,486	6/1913	Washburn	229/1.5 B	3,962,503	6/1976	Crawford	428/40
1,069,675	8/1913	Claussen	.		4,043,077	8/1977	Stonehocker	47/66
1,446,563	2/1923	Hughes	.		4,118,890	10/1978	Shore	47/28
1,520,647	12/1924	Hennegan	.		4,170,618	10/1979	Adams	264/101
1,632,347	6/1927	Pipkin	.		4,216,620	8/1980	Weder et al.	47/72
1,868,853	7/1932	Sievers	.		4,300,312	11/1981	Weder et al.	47/72
1,924,926	8/1933	Gray	.		4,408,644	10/1983	Svantesson	150/55
1,951,642	3/1934	Augustin et al.	47/34	4,413,725	11/1983	Bruno et al.	206/45.33
2,054,934	9/1936	Goraffenberger	229/1.5 B	4,508,223	4/1985	Catrambone	206/423
2,102,510	12/1937	Cecil, II	229/1.5 B	4,712,725	12/1987	Moore	229/8
2,302,259	11/1942	Rothfuss	41/10	4,733,521	3/1988	Weder et al.	53/580
2,355,559	8/1944	Renner	229/8	4,773,182	9/1988	Weder et al.	47/72
2,482,981	9/1949	Kamrass	41/13	4,795,601	1/1989	Cheng	264/138
					4,813,862	3/1989	Bowers et al.	425/87
					4,835,834	6/1989	Weder	29/525

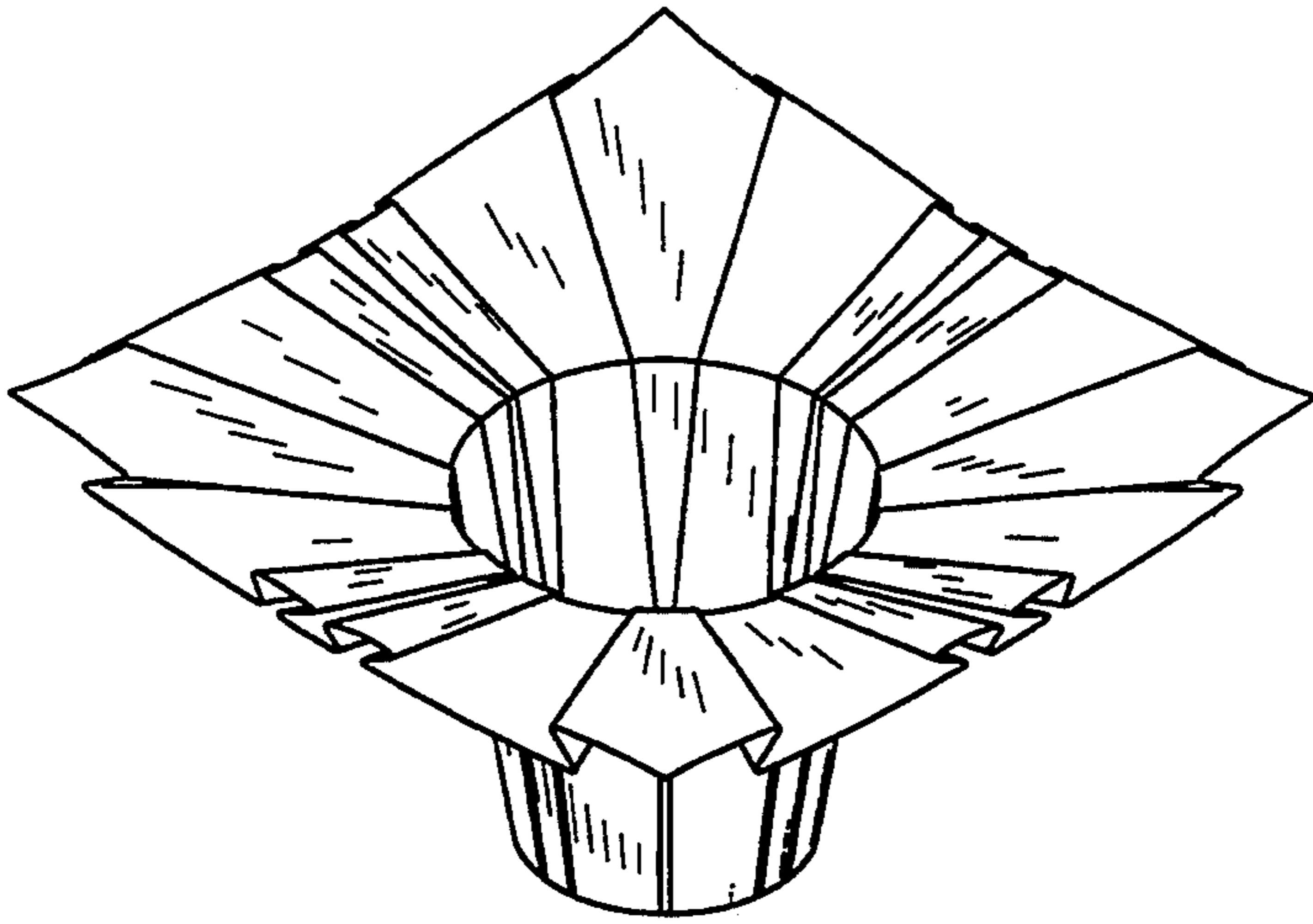

FIG. 1

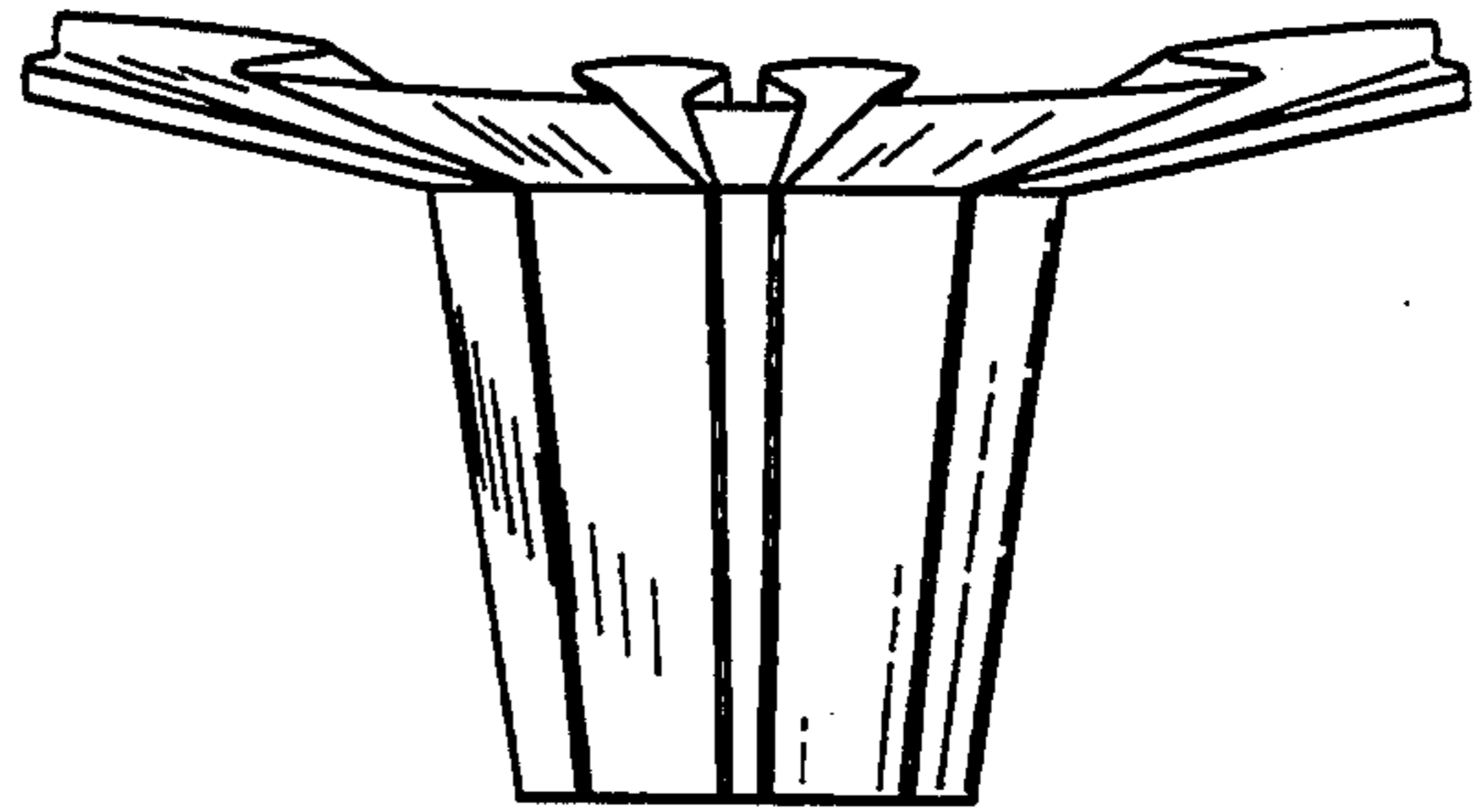

FIG. 2

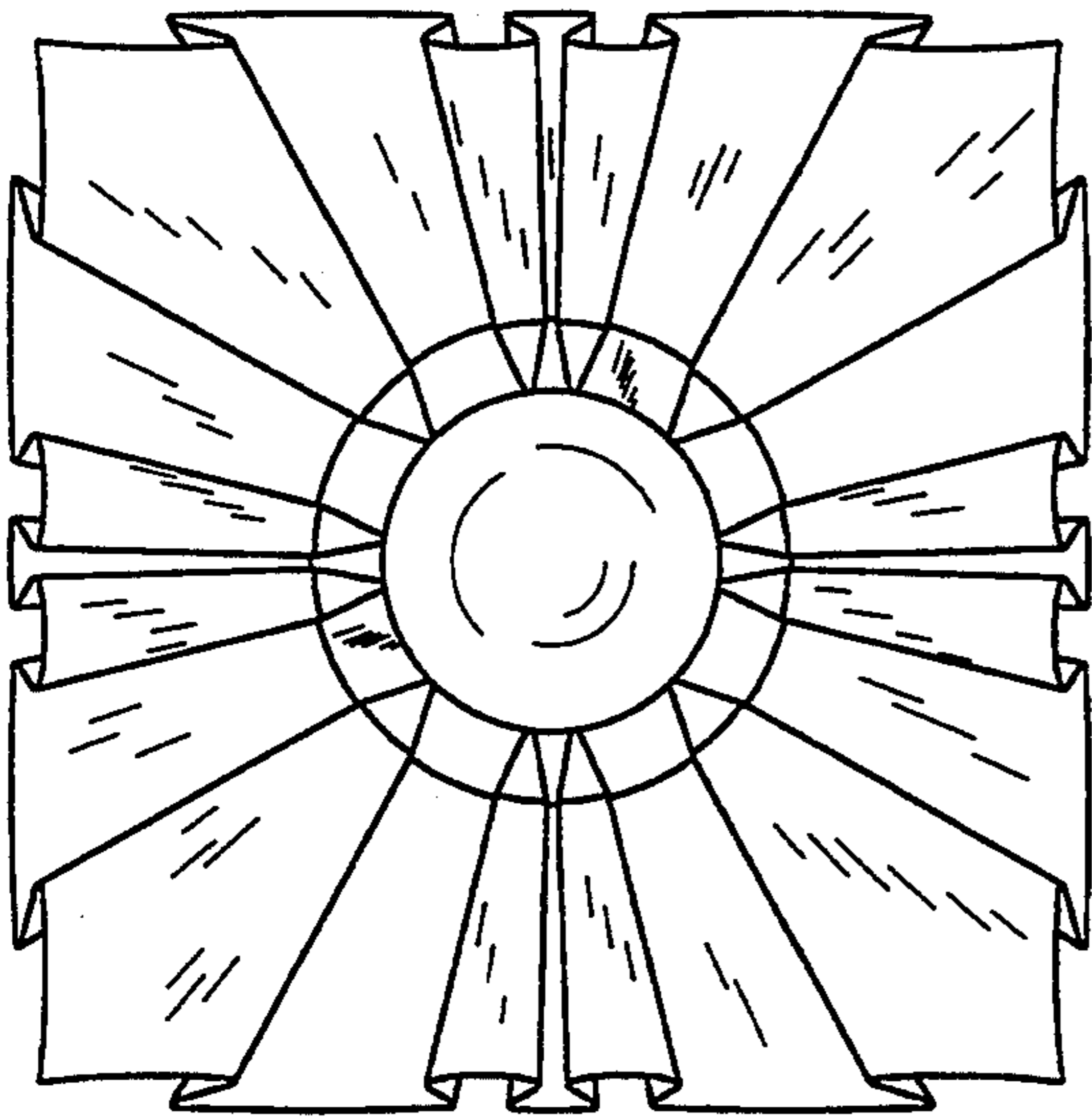

FIG. 3

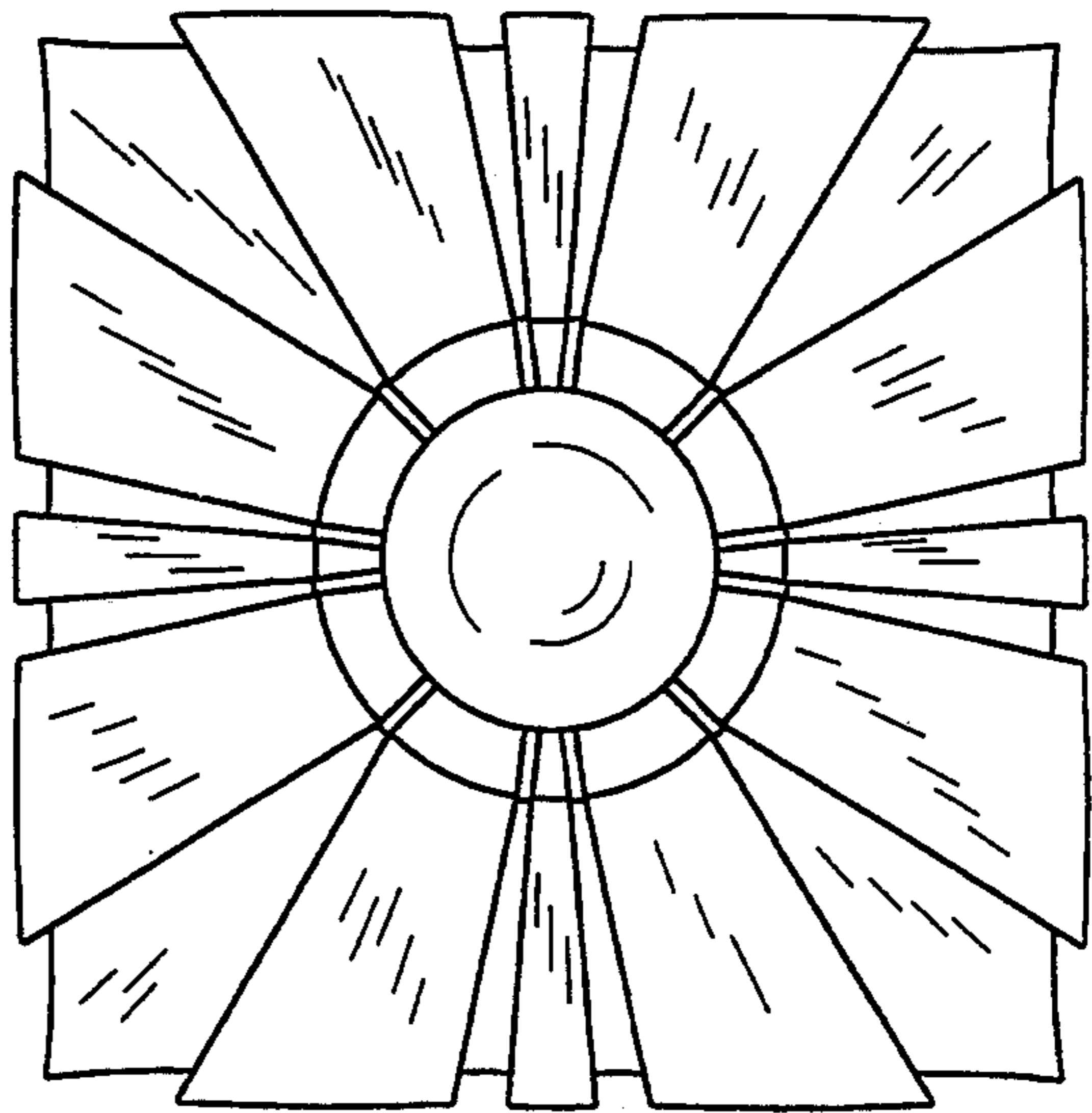

FIG. 4

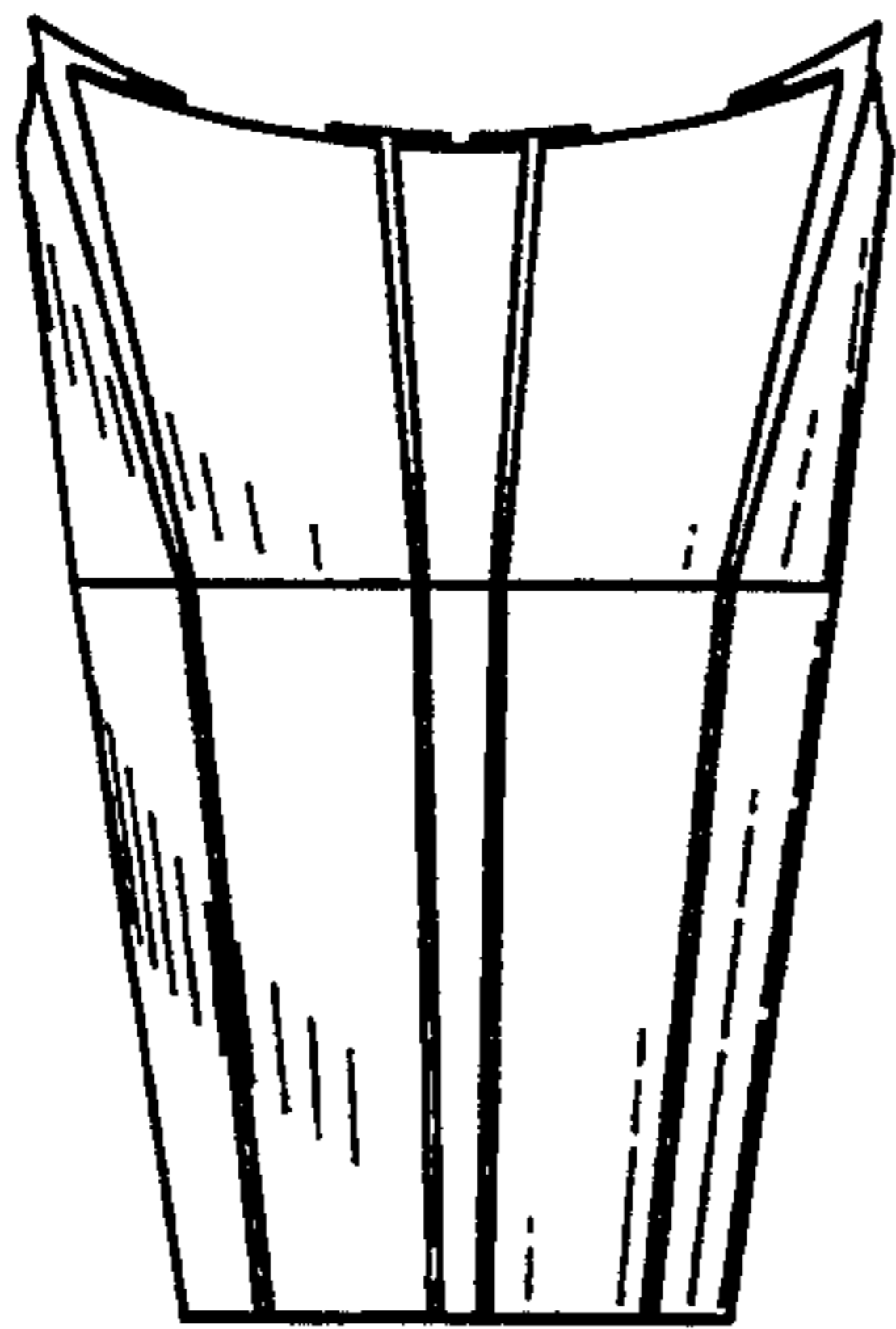

FIG. 5

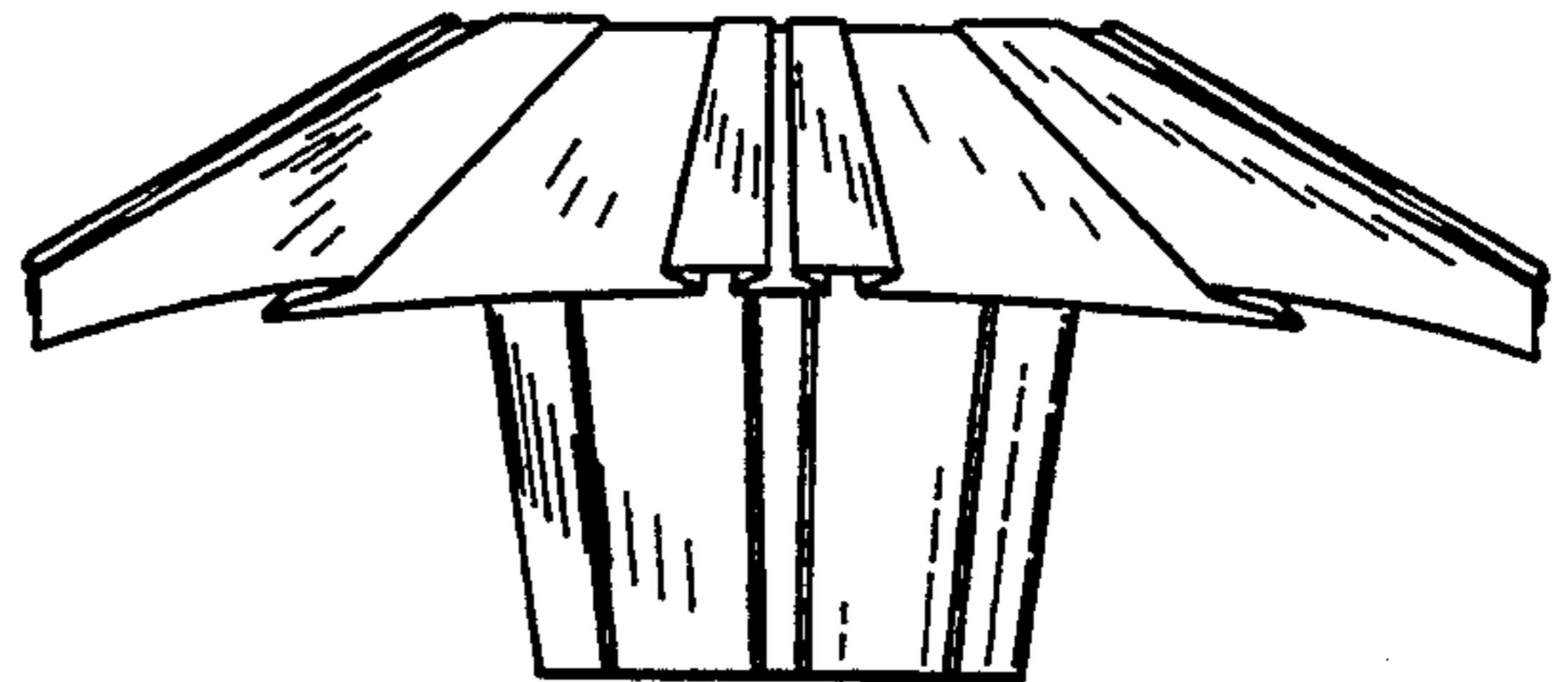

FIG. 6

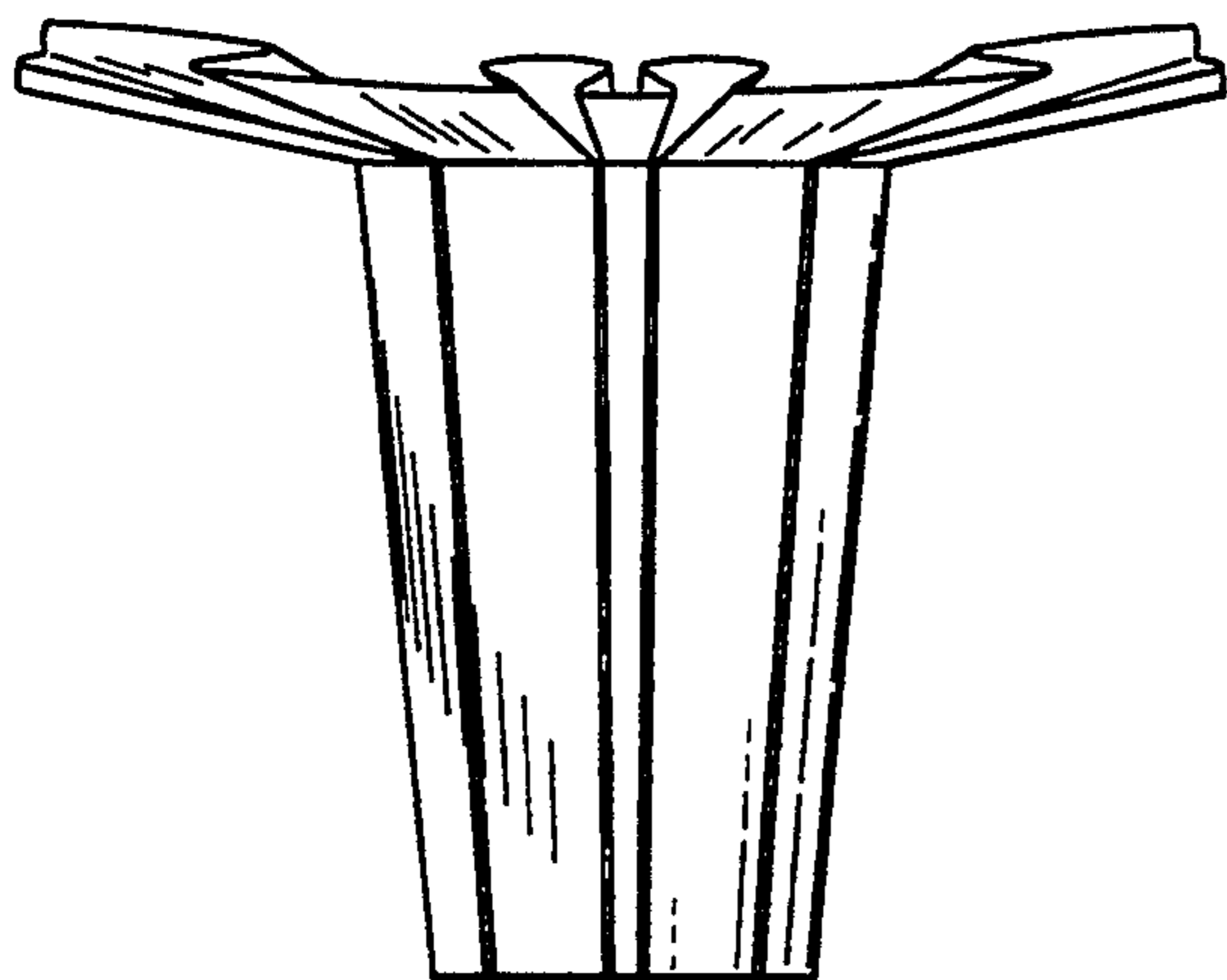

FIG. 7

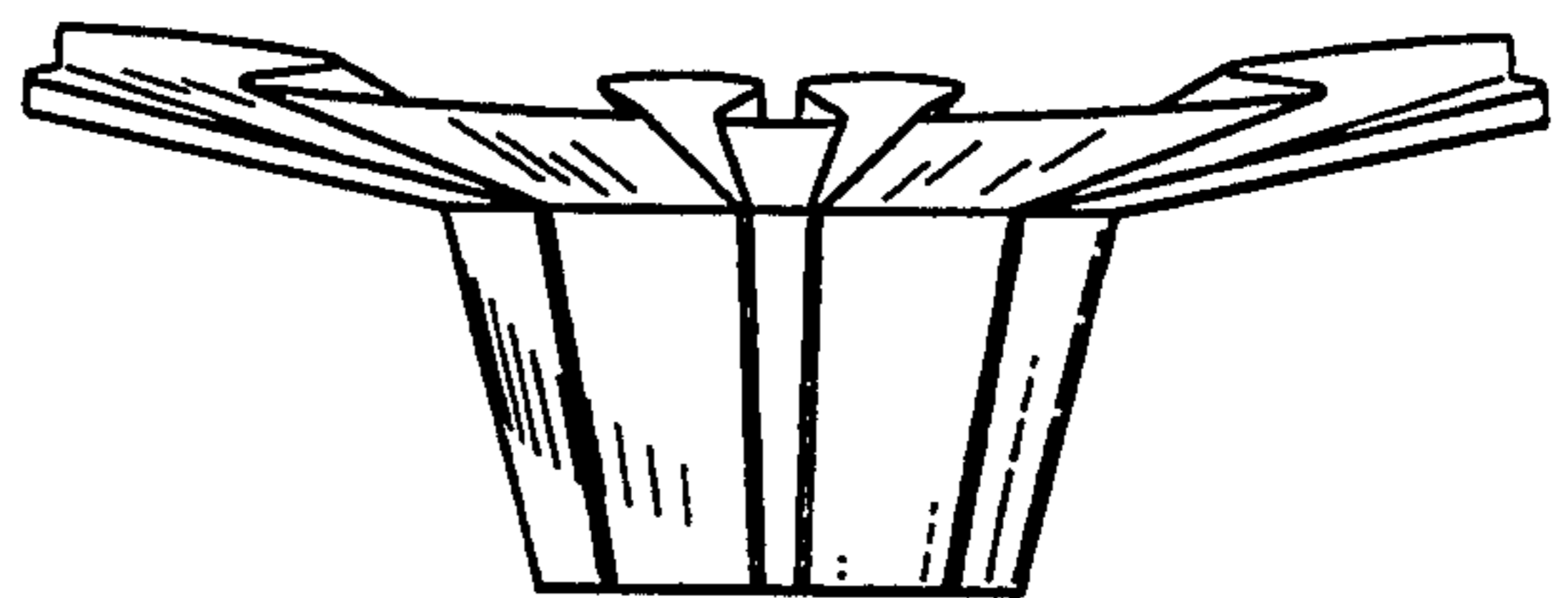

FIG. 8

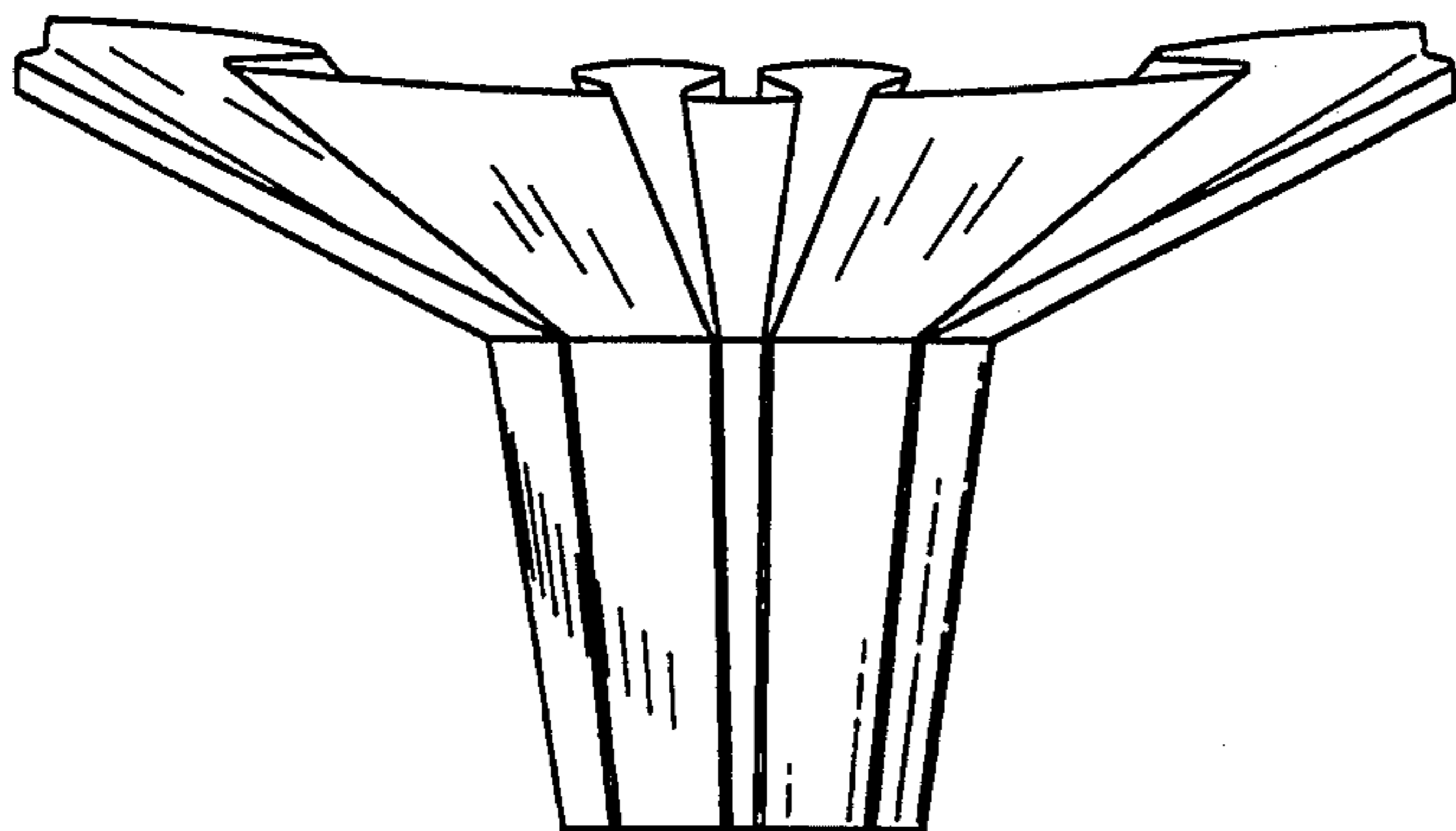

FIG. 9

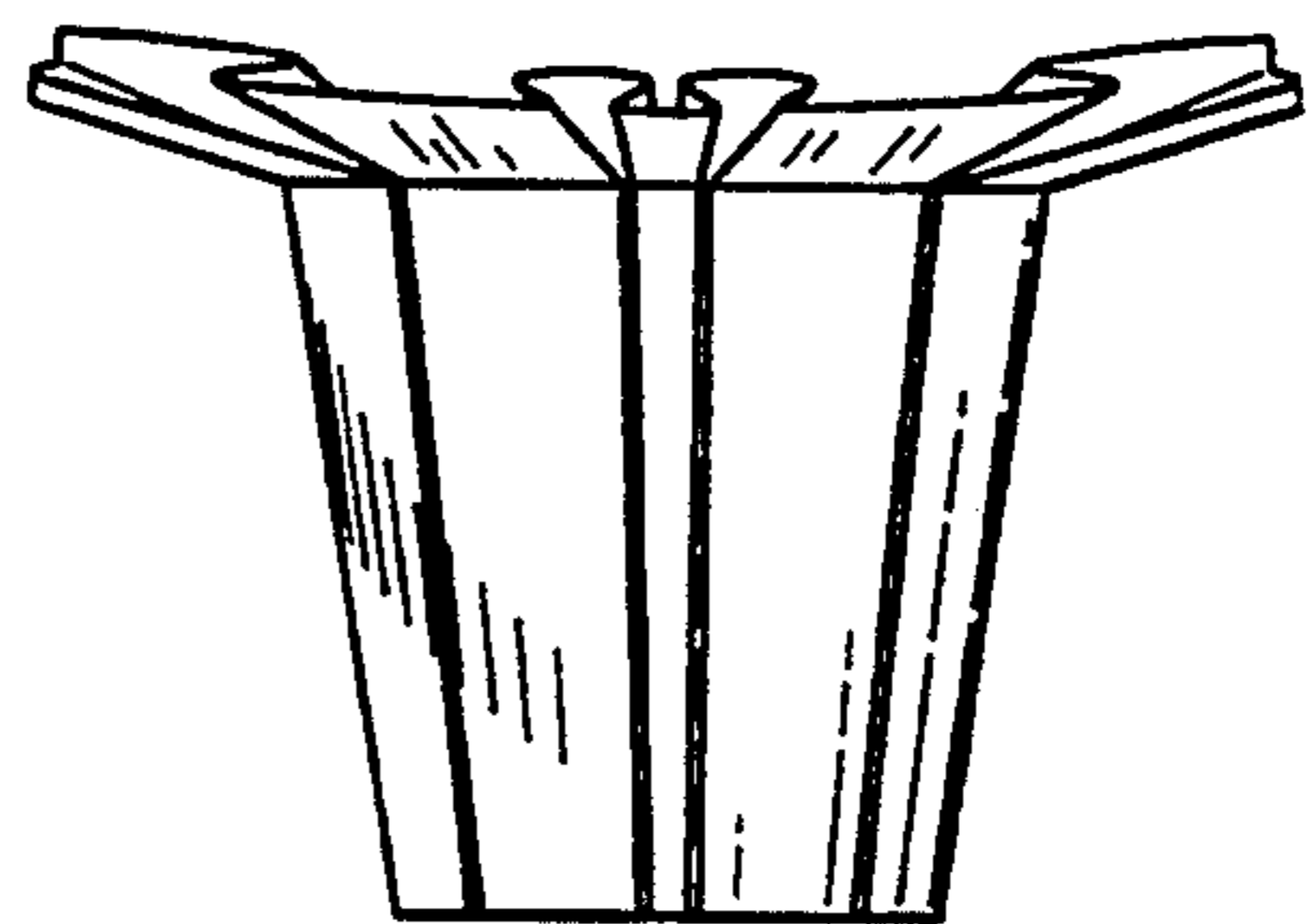

FIG. 10

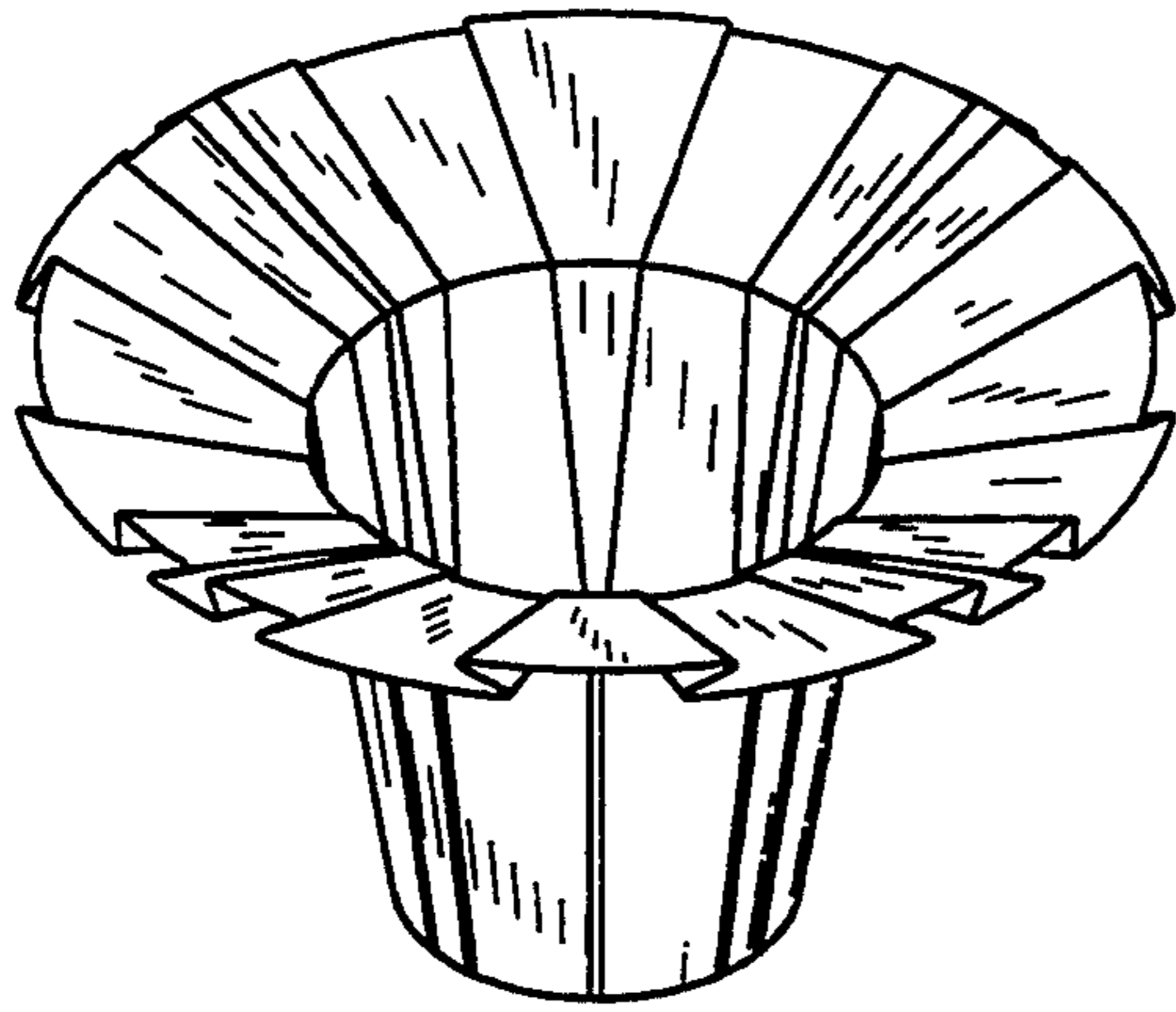

FIG 11

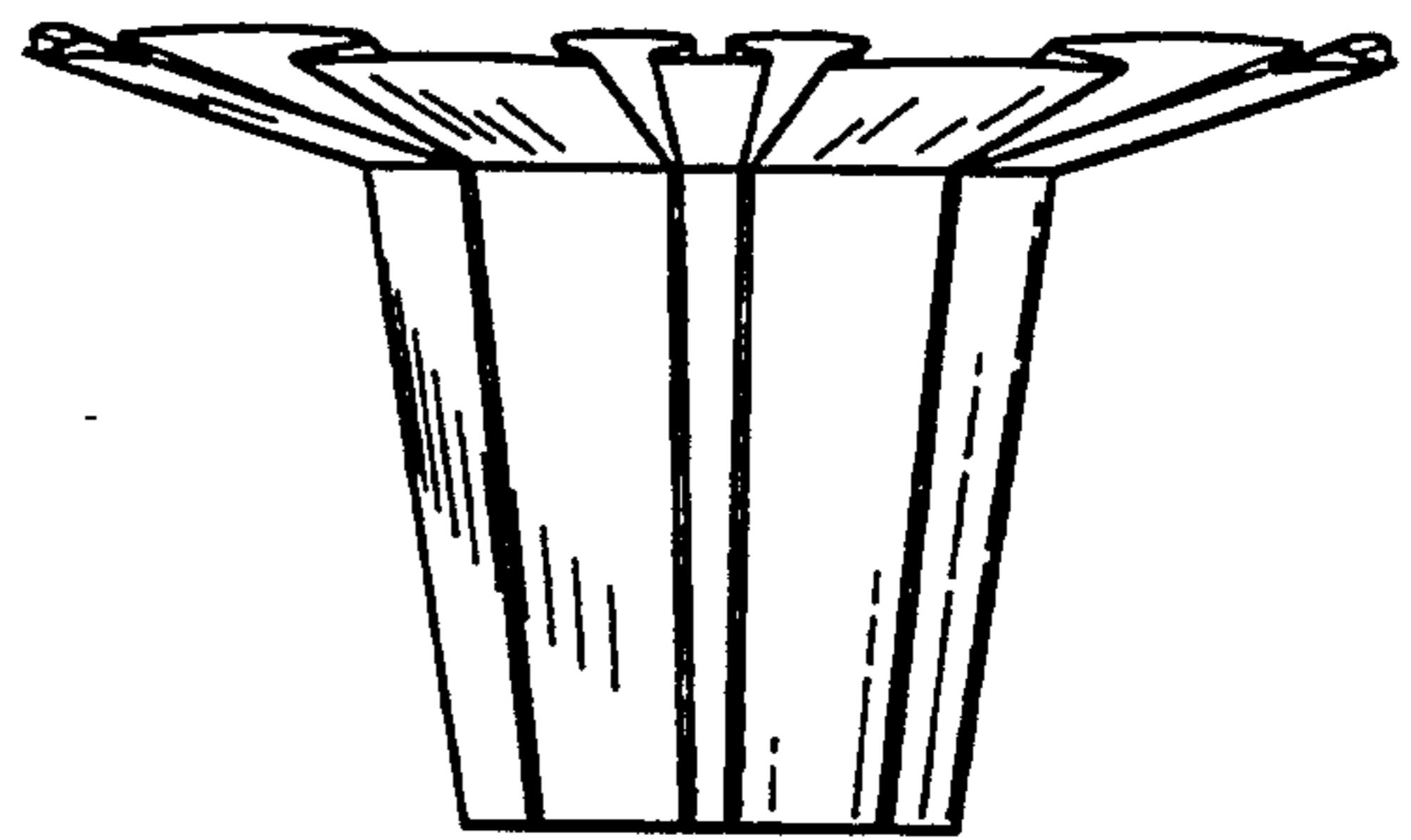

FIG 12

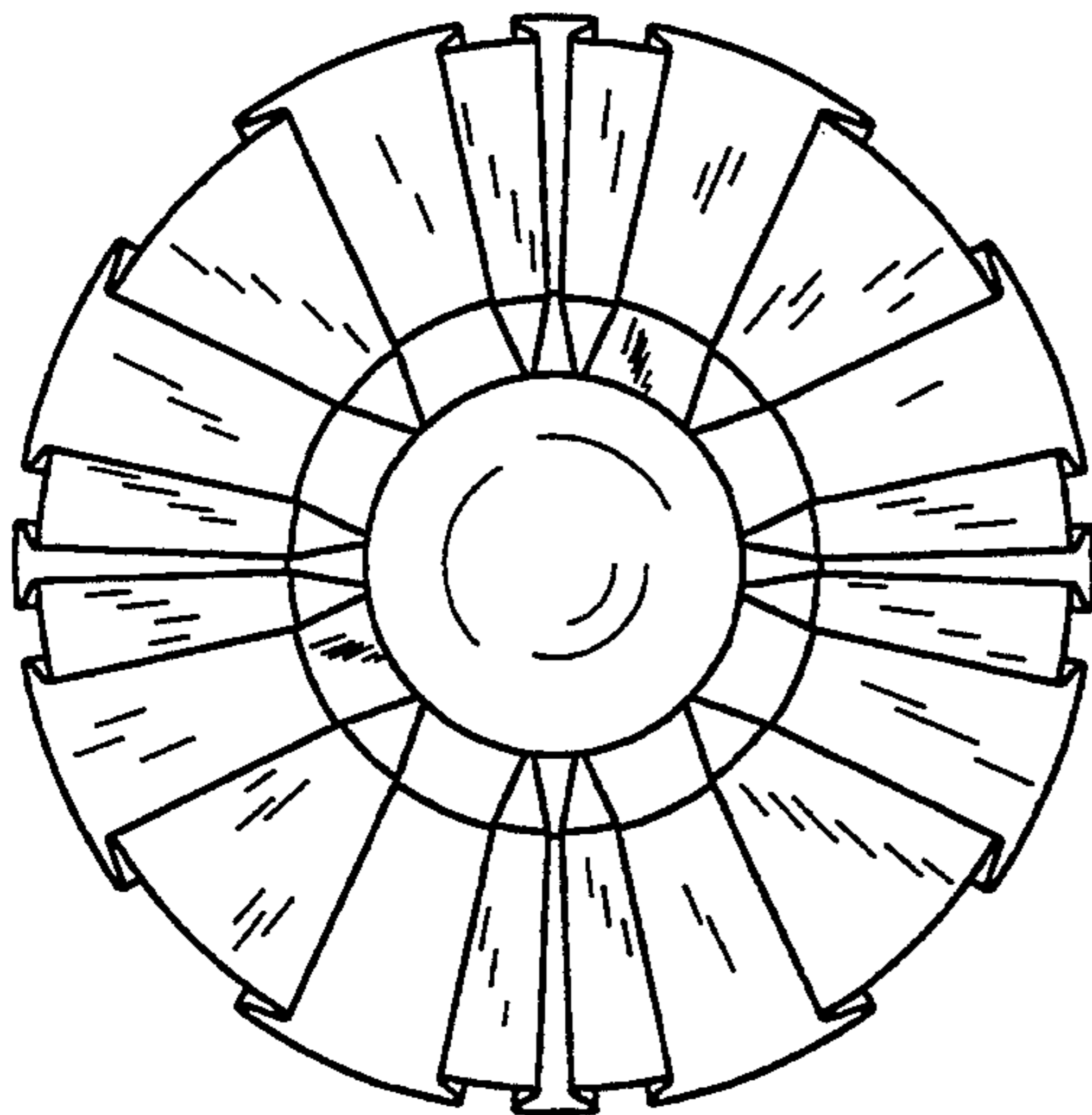

FIG 13

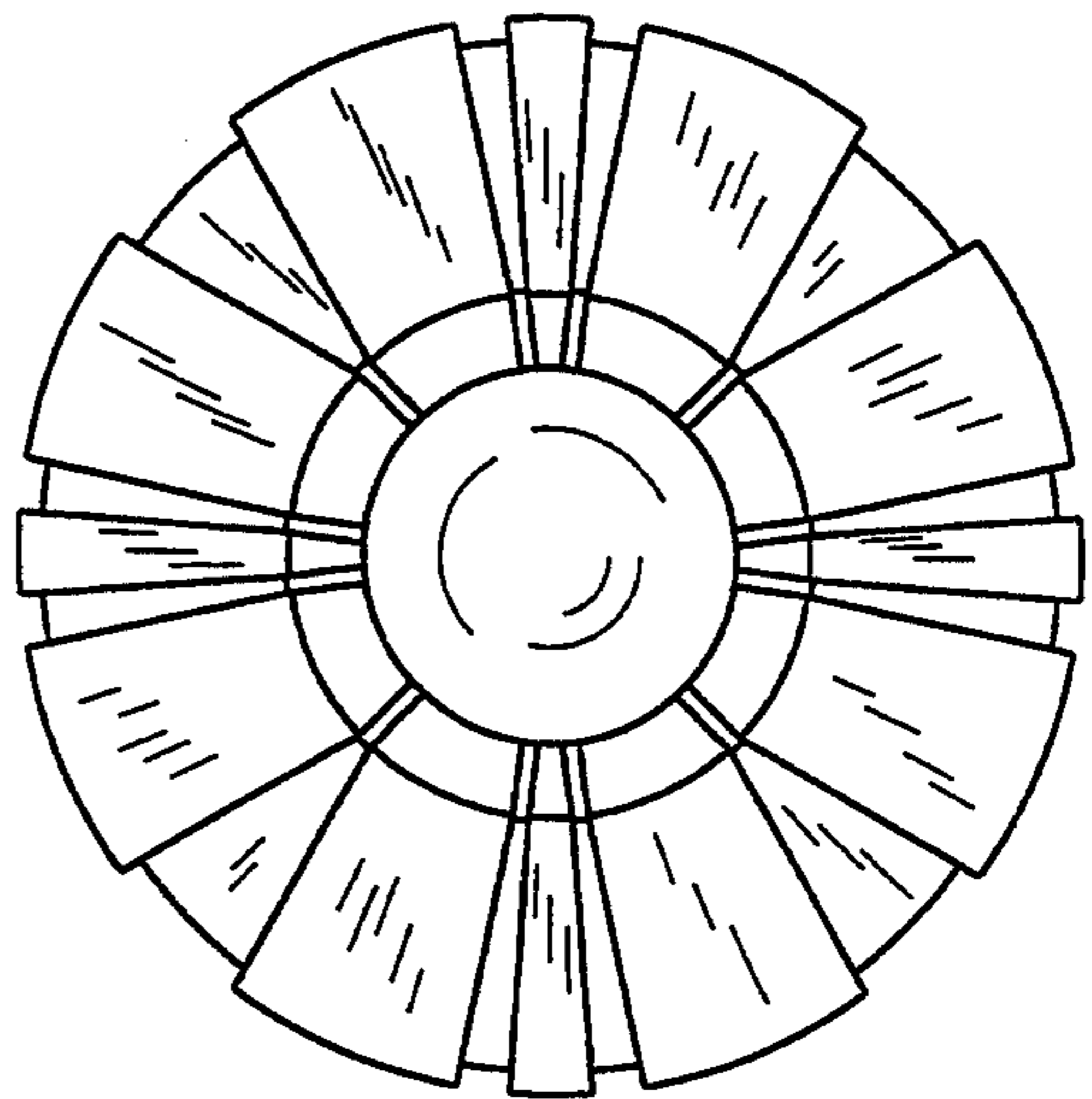

FIG 14

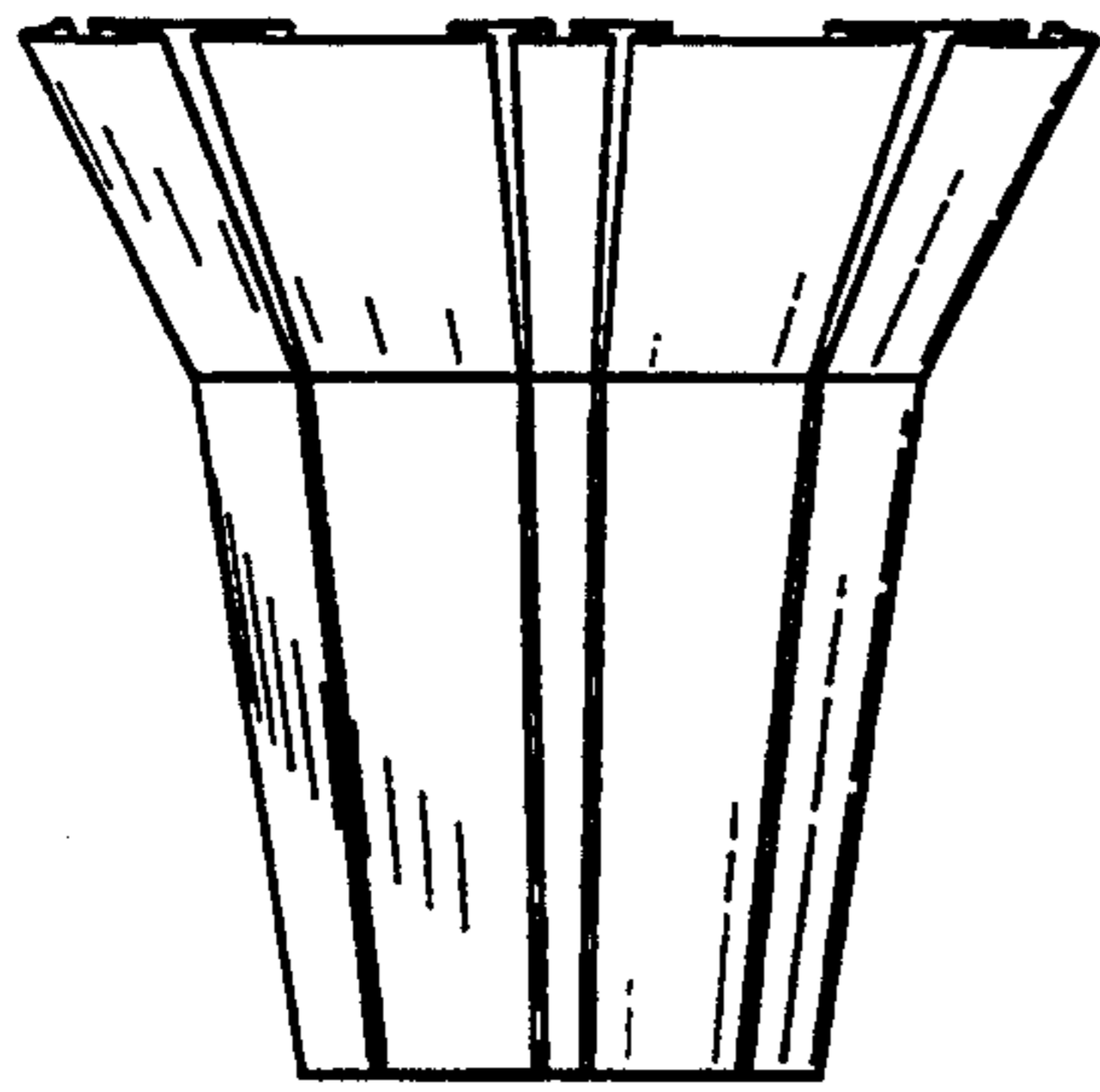

FIG. 15

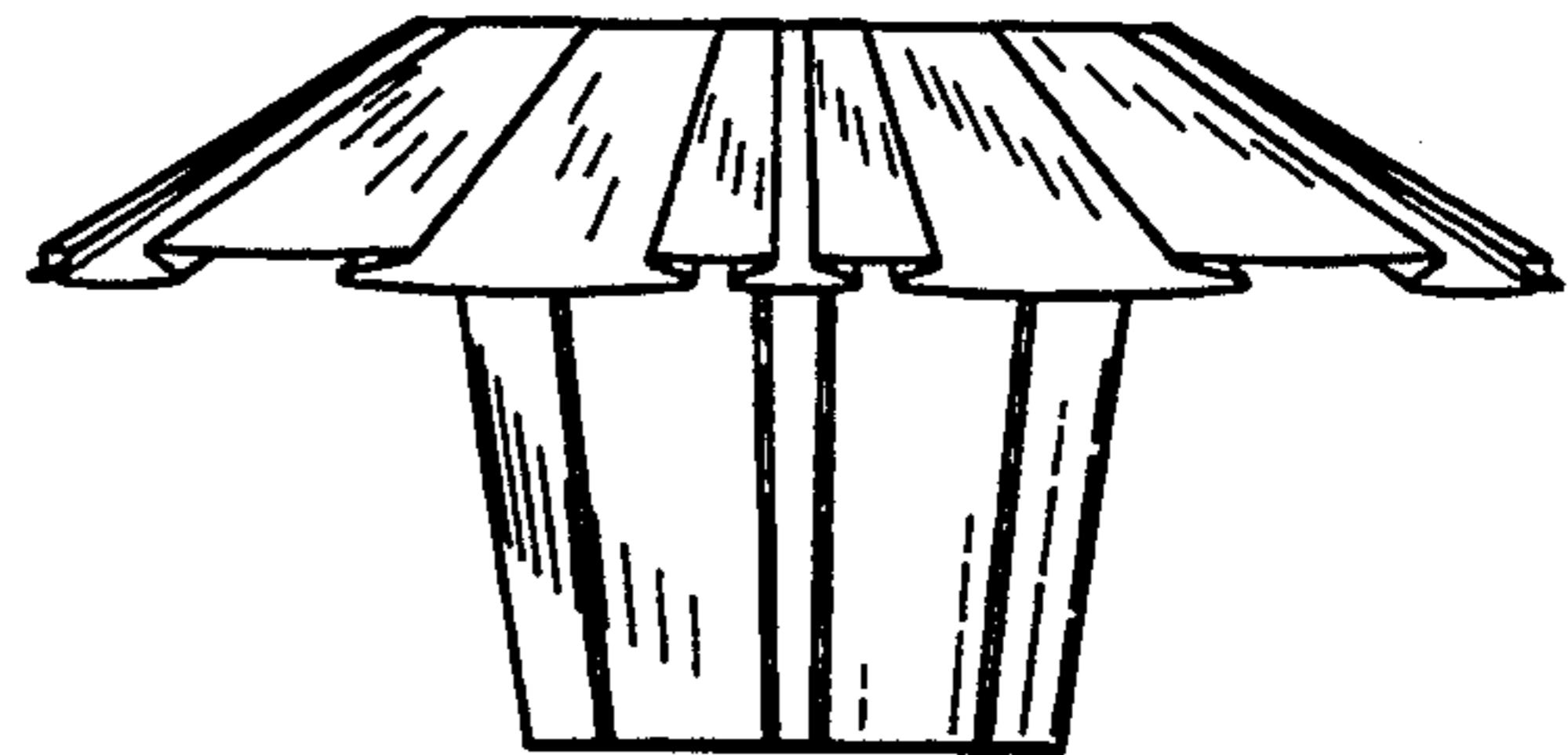

FIG. 16

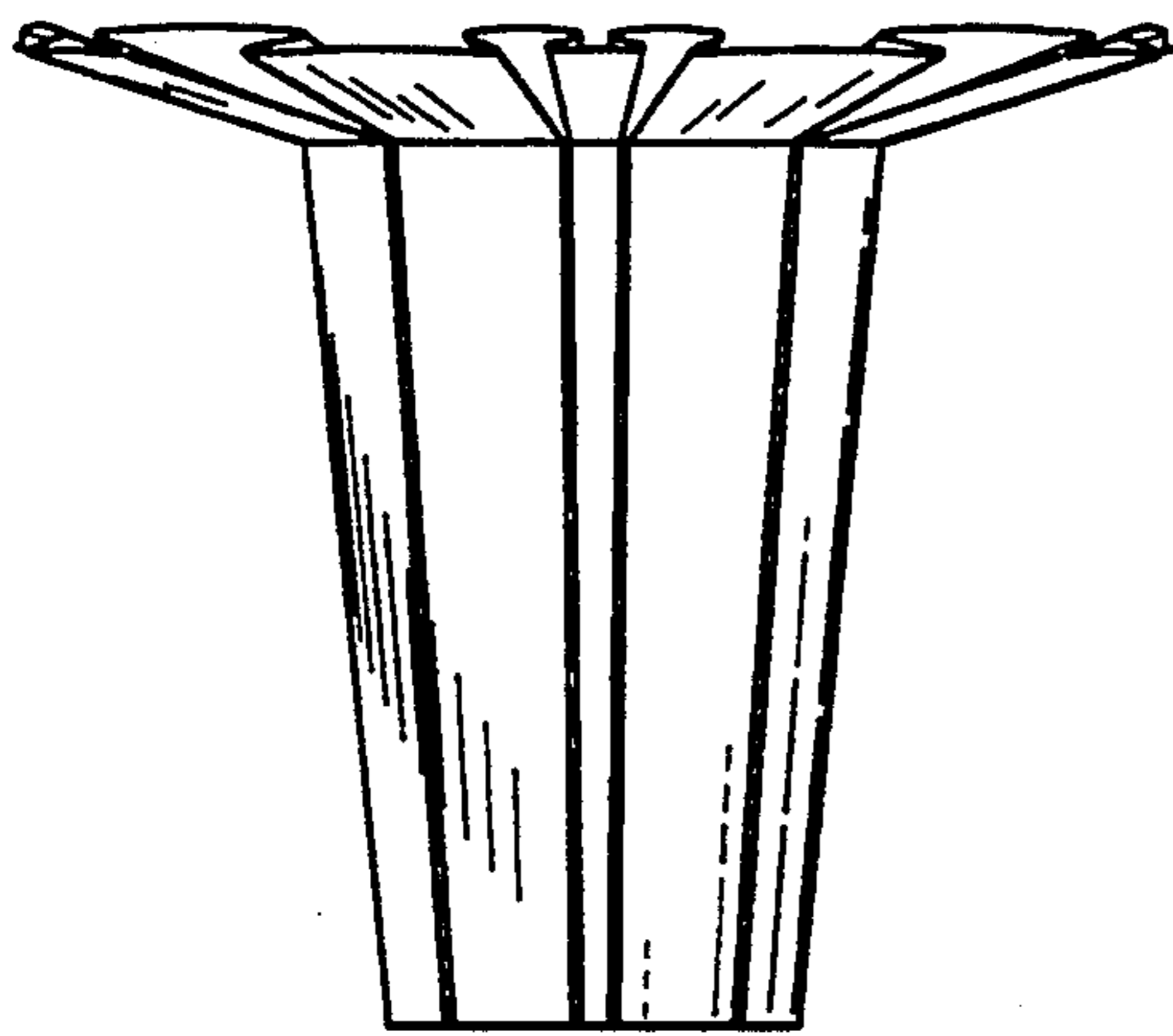

FIG. 17

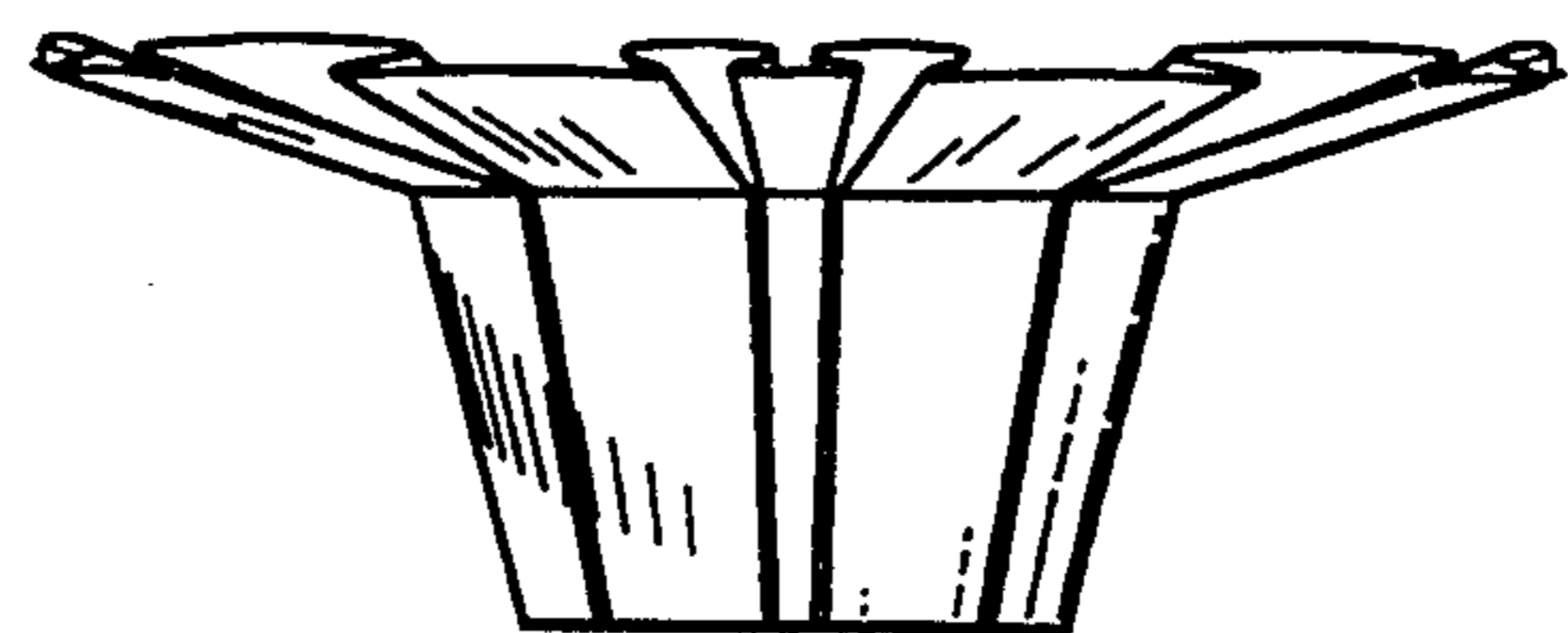

FIG. 18

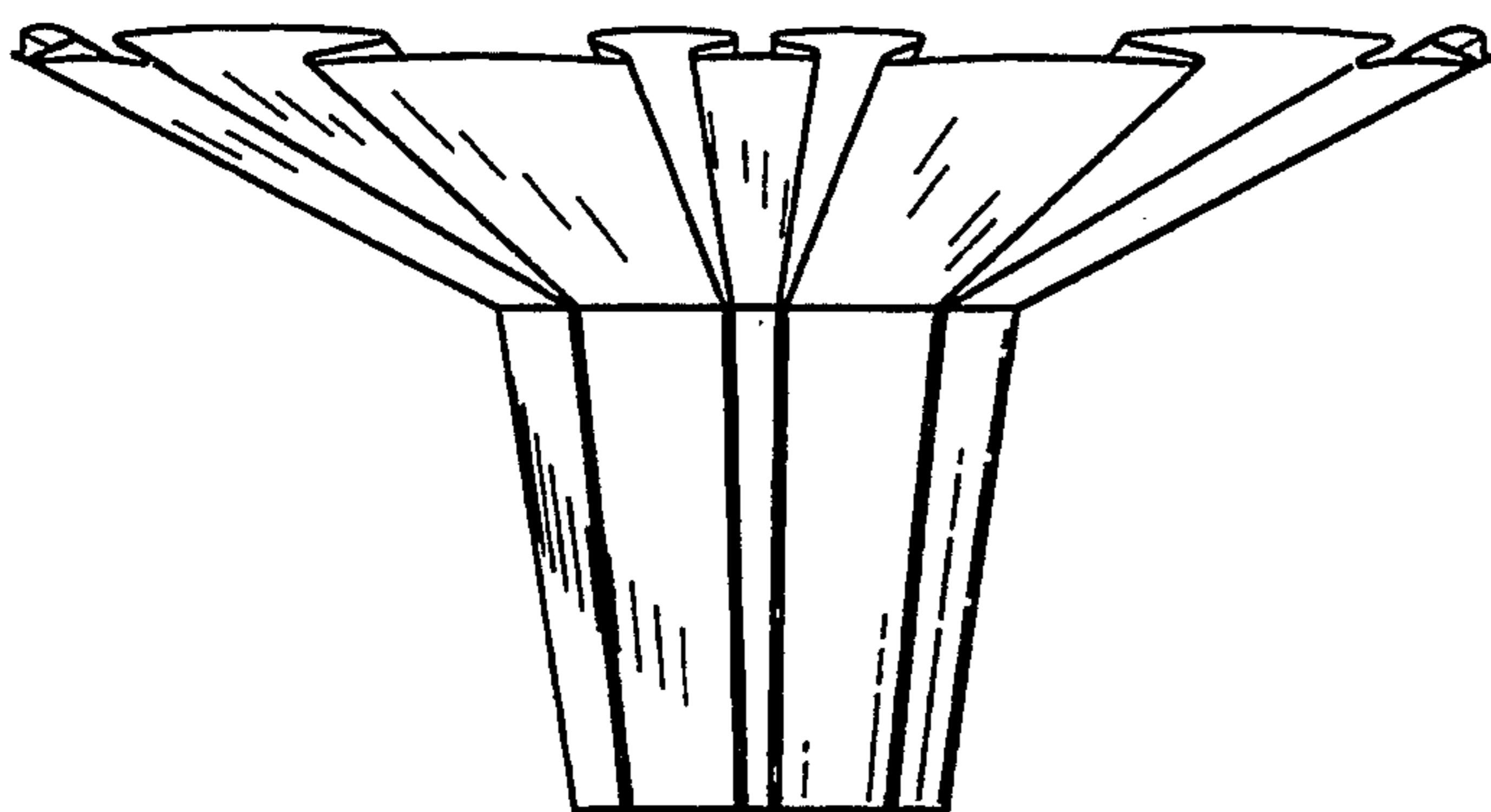

FIG. 19

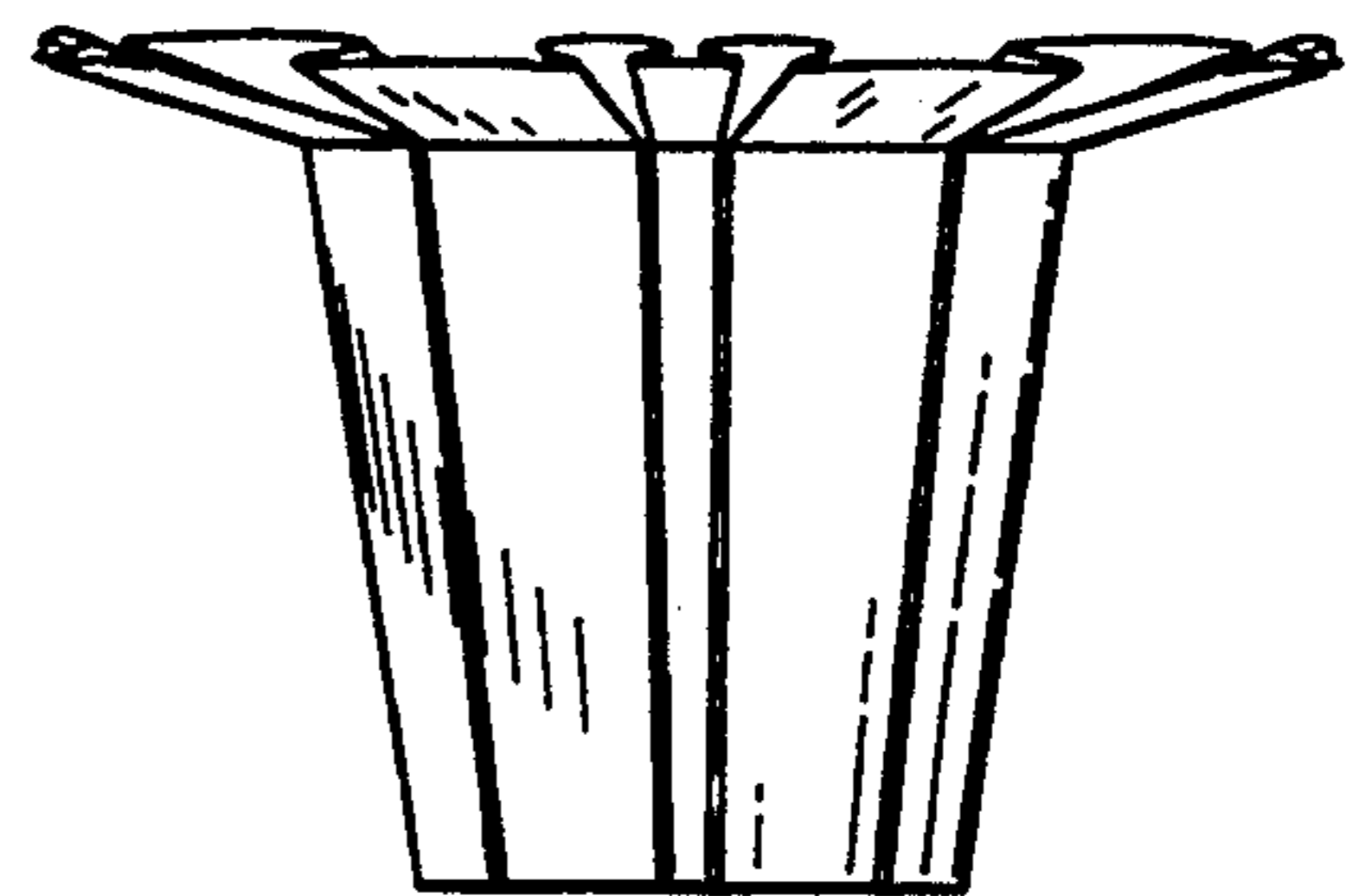

FIG. 20

UNITED STATES PATENT AND TRADEMARK OFFICE
CERTIFICATE OF CORRECTION

PATENT NO. : Des. 352,918
DATED : November 29, 1994
INVENTOR(S) : Weder et al.

It is certified that error appears in the above-identified patent and that said Letters Patent is hereby corrected as shown below:

On the title page: Item [56]

under 'DESCRIPTION', line 12, after the word 'elevational', please insert --view--.

under 'DESCRIPTION', line 14, after the word 'FIG.', please delete "[", and insert --8--.

under 'OTHER PUBLICATIONS', line 1, please insert --Exhibit A. Curtis Wagner Co., Inc. Houston, TX, shows thick, stiff shiny red plastic pot cover with large scalloped border. (Photograph) Date Unknown.

under 'OTHER PUBLICATIONS', after the last paragraph, please insert the following new paragraph, --Exhibit O. SPEED COVER BROCHURE - THE SIMPLE SOLUTION..., © 1989.--

Signed and Sealed this
Twenty-fifth Day of April, 1995

Attest:



BRUCE LEHMAN

Attesting Officer

Commissioner of Patents and Trademarks