



US00D352832S

United States Patent [19]

[11] Patent Number: **Des. 352,832**

Brazis et al.

[45] Date of Patent: **** Nov. 29, 1994**

[54] **BRUSH HANDLE**

[75] Inventors: **William E. Brazis; David L. Feer,**
both of Medina, Ohio

[73] Assignee: **Rubbermaid Incorporated,** Wooster,
Ohio

[**] Term: **14 Years**

[21] Appl. No.: **818,967**

[22] Filed: **Jan. 10, 1992**

[52] U.S. Cl. **D4/138**

[58] Field of Search **D4/130-138;**
15/104.002, 143.1, 159.1, 160

[56] **References Cited**

U.S. PATENT DOCUMENTS

D. 18,975	3/1889	Berry	D4/138
D. 223,017	2/1972	Pharris et al.	D4/138
D. 223,018	2/1972	Pharris et al.	D4/138
D. 305,481	1/1990	Bruno et al.	D4/132
3,040,352	6/1992	Vian	15/104.002
4,422,201	12/1983	McKay	15/104.002
4,557,011	12/1985	Sartori	15/104.002
4,570,280	2/1986	Roth	15/104.002

OTHER PUBLICATIONS

Price List, Brushes, Helmac Products Corporation,
P.O. Box 73, Flint, Mich. 48501-0073 Publication date
Jan., 1990.

P. 23, Brushes, Empire Brush, Inc., U.S. Highway 13
North, P.O. Box 1606, Greenville, N.C. 27835, Publica-
tion date 1986.

Label and Photograph, Brush, Empire Brush, Inc., U.S.
Highway 13 North, P.O. Box 1606, Greenville, N.C.
27835, Publication date 1987.

Label, Brush, Roth (Plastics) Corporation, P.O. Box
434, Lewiston, N.Y. 14092 Publication date 1978.

Catalog Page, Brush, Dupol-Rubbermaid GmbH, Fab-
rik fur Gummiund Kunststtsfferzeugnisse, 60 72 Dreiei-
chenhain bei Ffm., West Germany, Publication date
1970.

Catalog Page, Brush, Dupol-Rubbermaid GmbH, Fab-
rik fur Gummiund Kunststtsfferzeugnisse, 60 72 Dreiei-
chenhain bei Ffm, West Germany Publication date
1971.

Catalog Page, Brush, Dupol-Rubbermaid GmbH, Fab-

rik for Gummiund Kunststtsfferzeugnisse, 60 72 Dreiei-
chenhain bei Ffm., West Germany Publication date
1972.

Catalog Page, Brush Dupol-Rubbermaid GmbH, Fab-
rik fur Gummiund Kunststtsfferzeugnisse, 60 72 Dreiei-
chenhain bei Ffm., West Germany Publication date
1972.

Catalog Page, Brush, Dupol-Rubbermaid GmbH, Fab-
rik fur Gummiund Kunststtsfferzeugnisse, 60 72 Dreiei-
chenhain bei Ffm., West Germany Publication date
1972.

Primary Examiner—Wallace R. Burke
Assistant Examiner—Lavone D. Tabor
Attorney, Agent, or Firm—Richard B. O'Planick; Lisa B.
Riedesel

[57] **CLAIM**

The ornamental design for a brush handle, as shown and
described.

DESCRIPTION

FIG. 1 is a top left front perspective view of a brush
handle showing our new design, and showing, in phan-
tom, a lint roller head which may be placed on said
brush handle;

The broken lines are for illustrative purposes only and
form no part of the claimed design;

FIG. 2 is a top plan view thereof; the bottom plan being
a mirror image;

FIG. 3 is a front elevational view thereof;

FIG. 4 is a left side elevational view thereof;

FIG. 5 is a right side elevational view thereof;

FIG. 6 is a top left front perspective view of an alternate
embodiment of a brush handle showing our new design,
and showing, in phantom, a padded brush head which
may be attached to said alternate embodiment;

FIG. 7 is a top elevational view of the alternate embodi-
ment; the bottom elevational view being a mirror im-
age;

FIG. 8 is a left side elevational view thereof;

FIG. 9 is a right side elevational view thereof; and,

FIG. 10 is a front elevational view thereof.

The undisclosed rear elevational views opposite FIGS.
3 and 10 are unornamented and follow the contours
shown at the top of FIGS. 2 and 7 respectively.

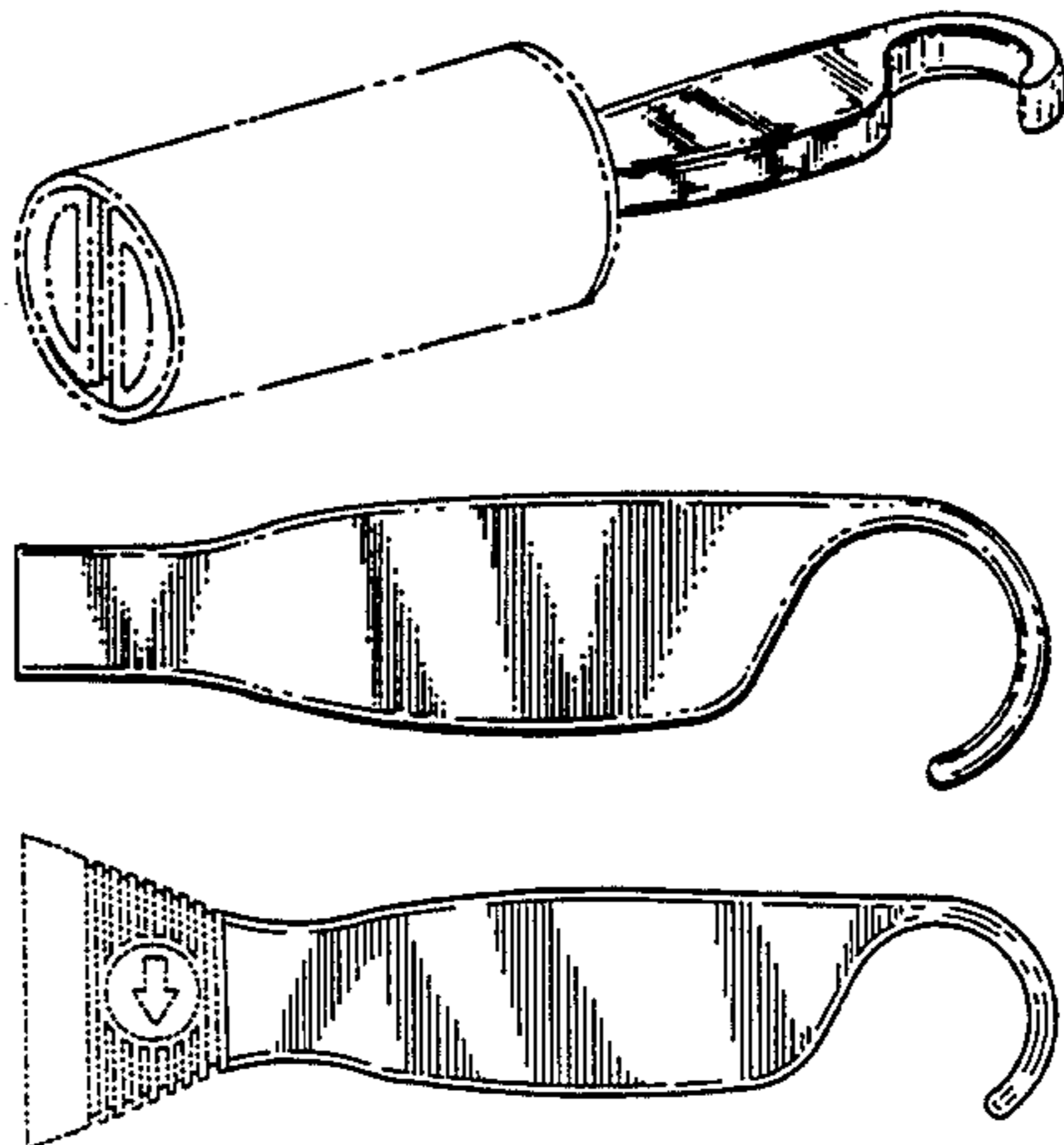

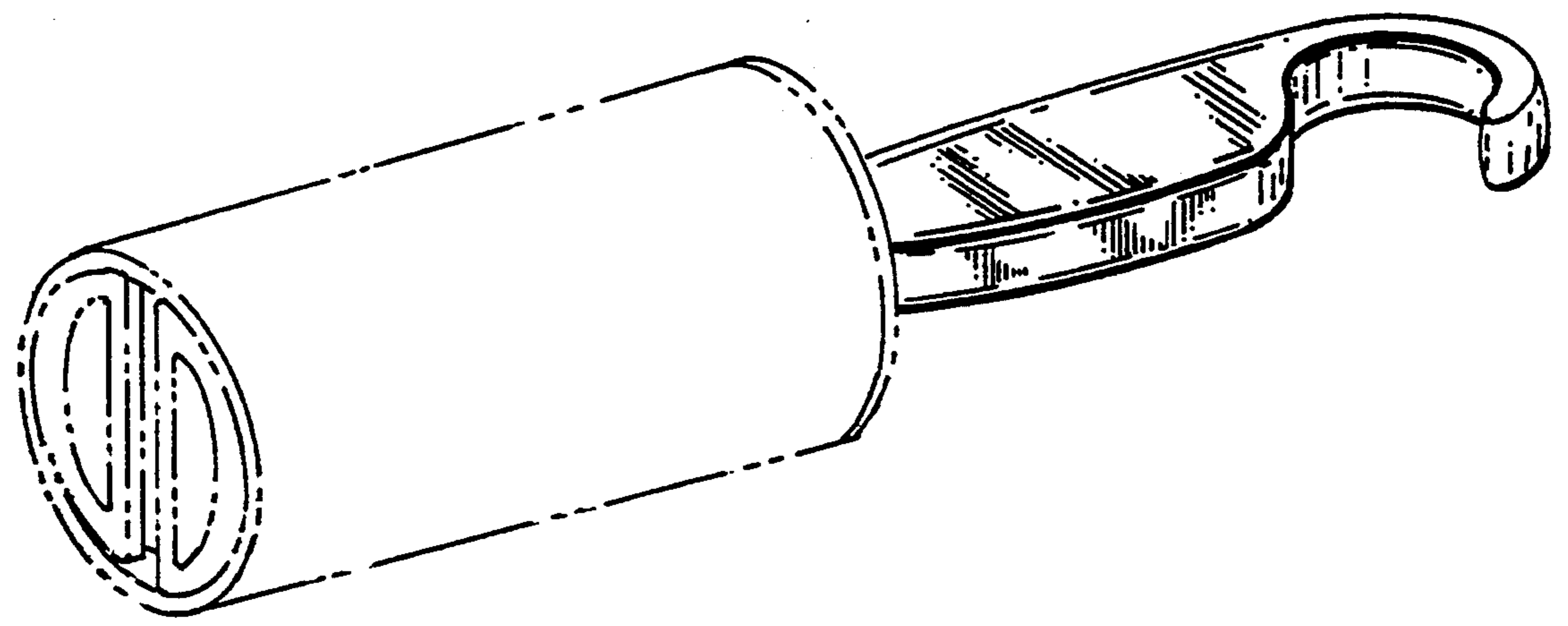

FIG. 1

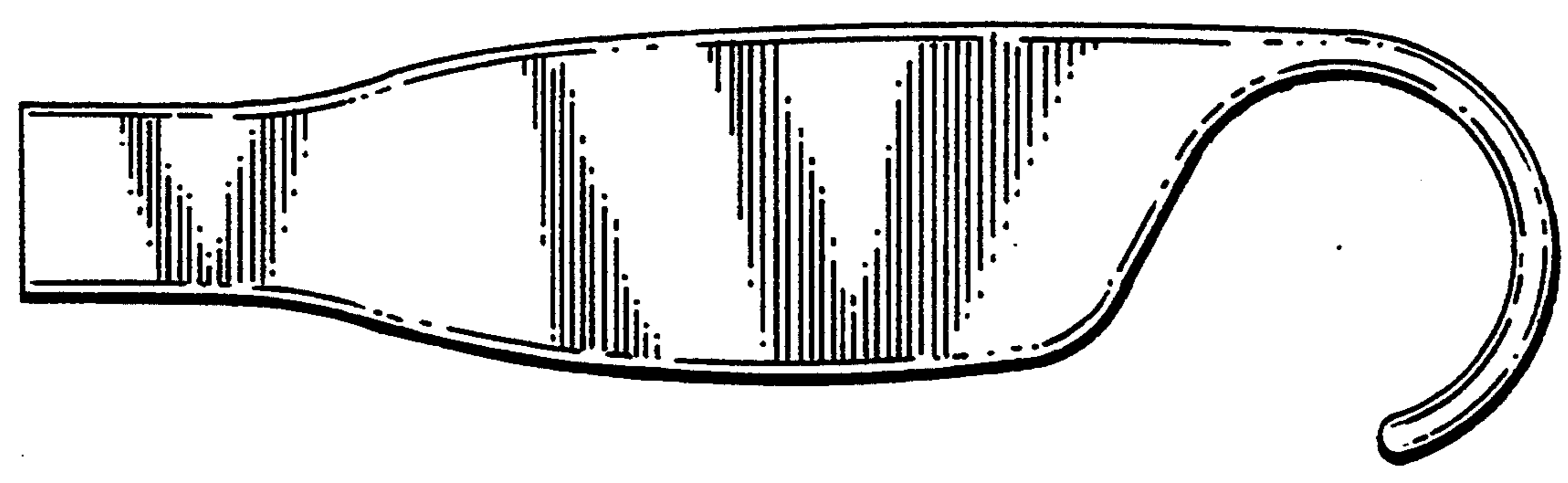

FIG. 2

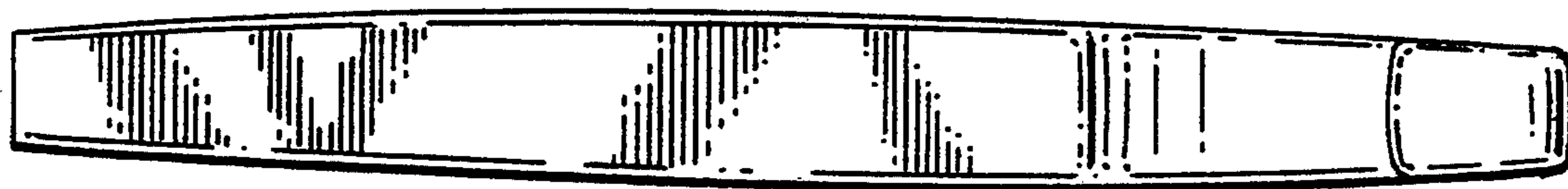

FIG. 3

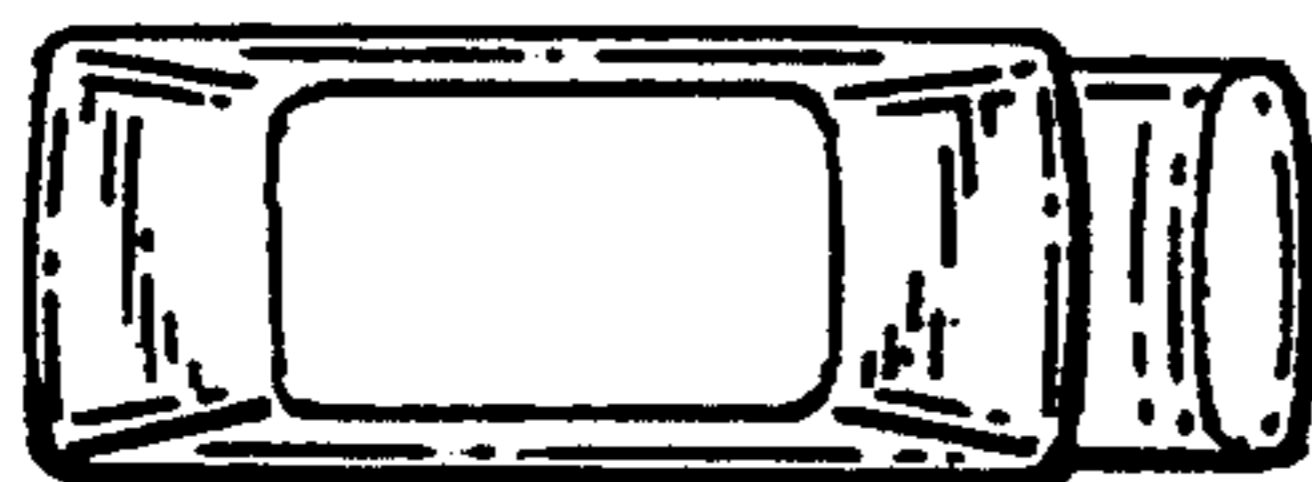

FIG. 4

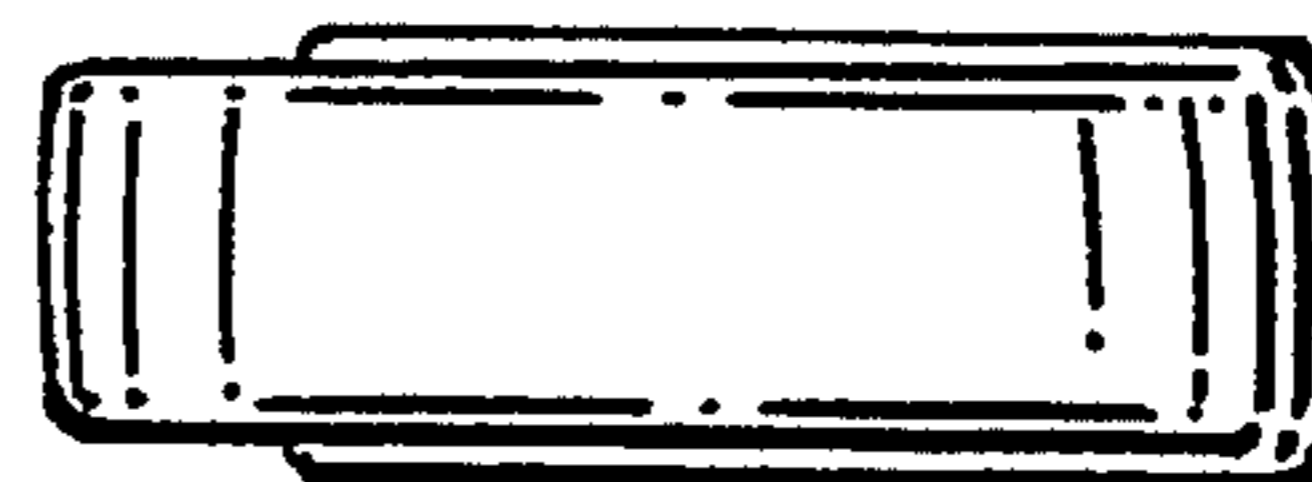

FIG. 5

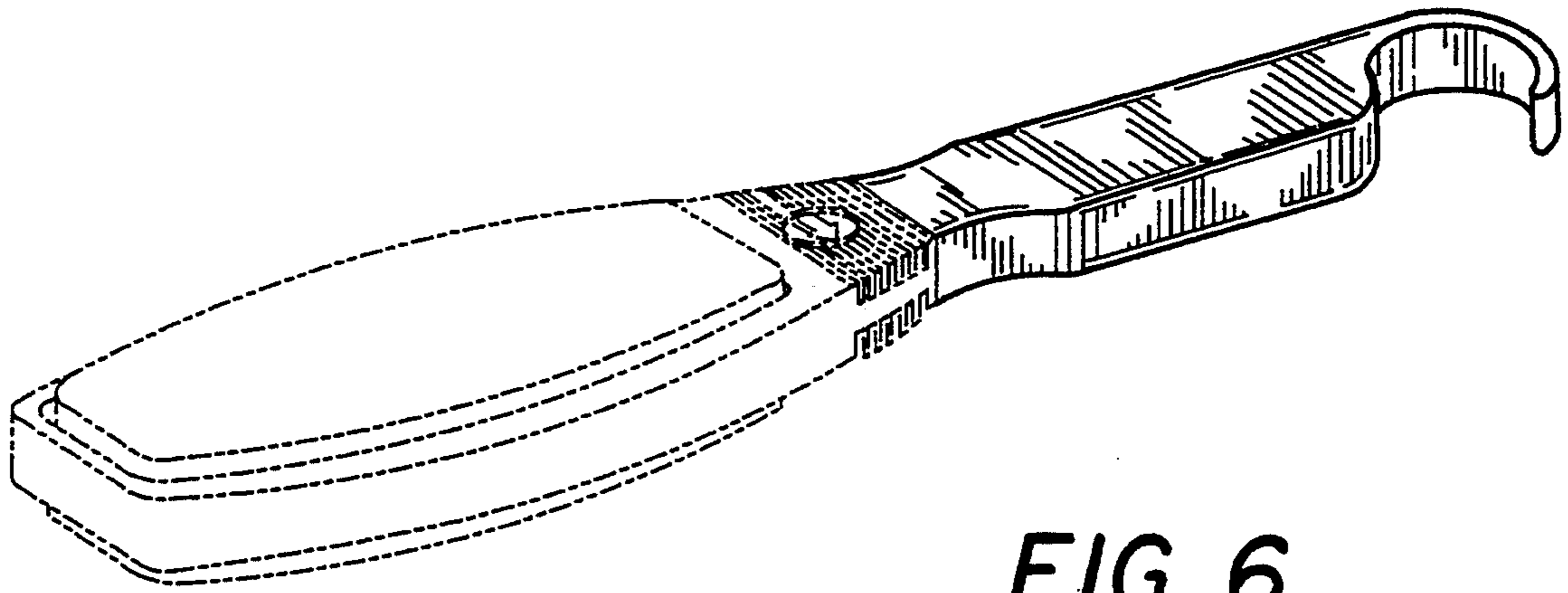

FIG. 6

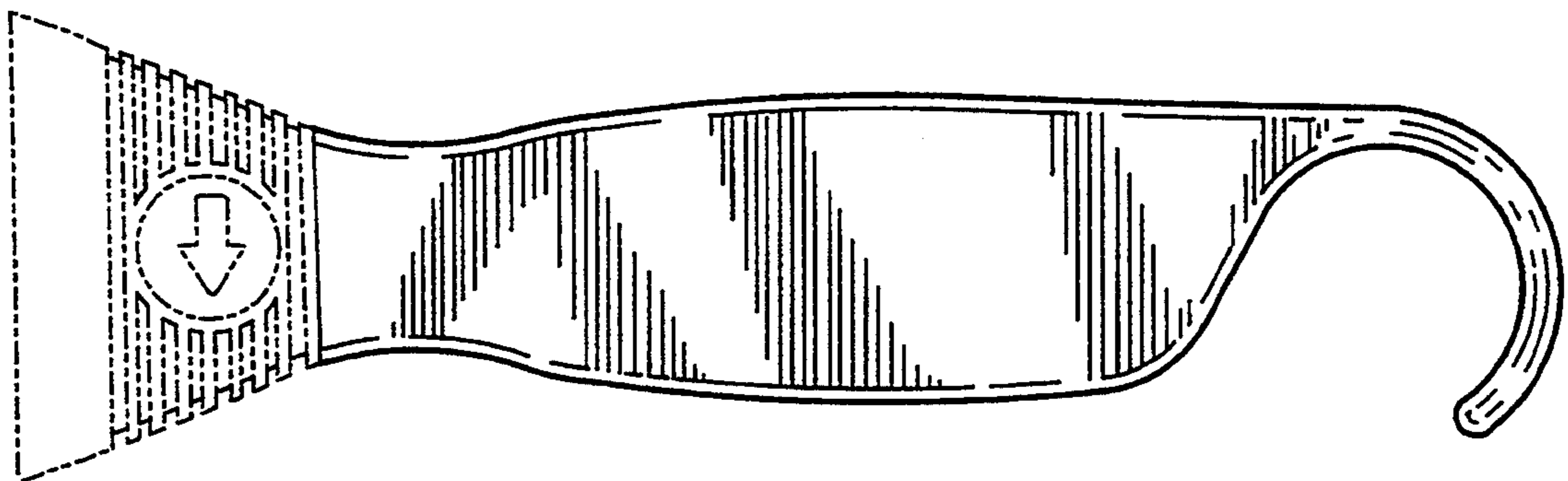

FIG. 7

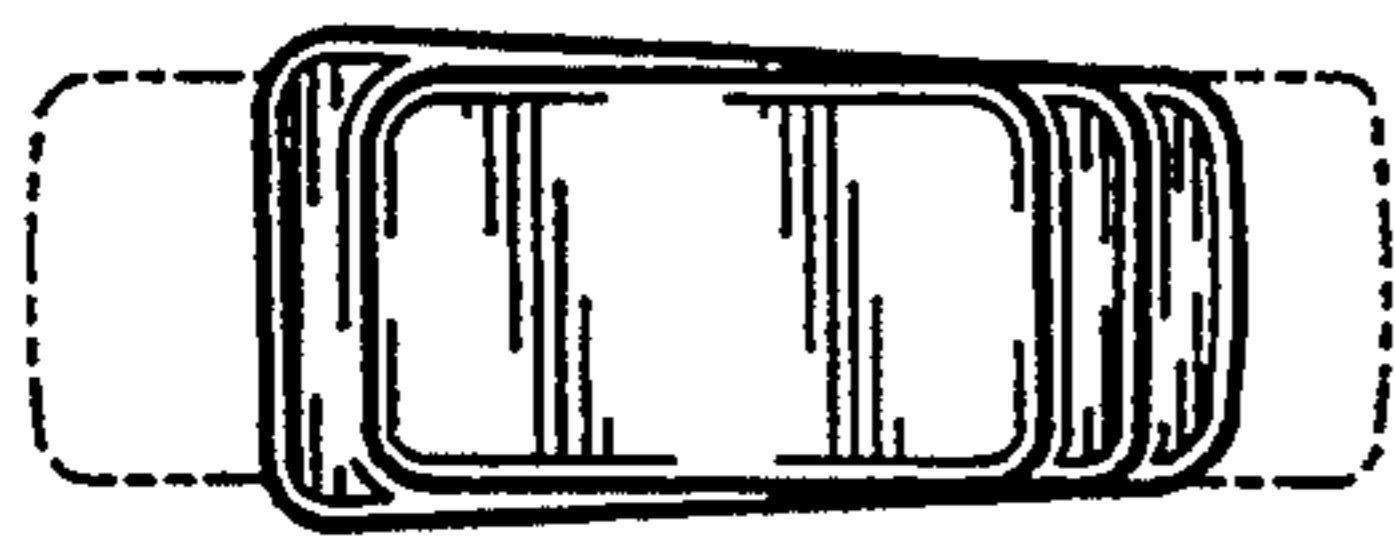

FIG. 8

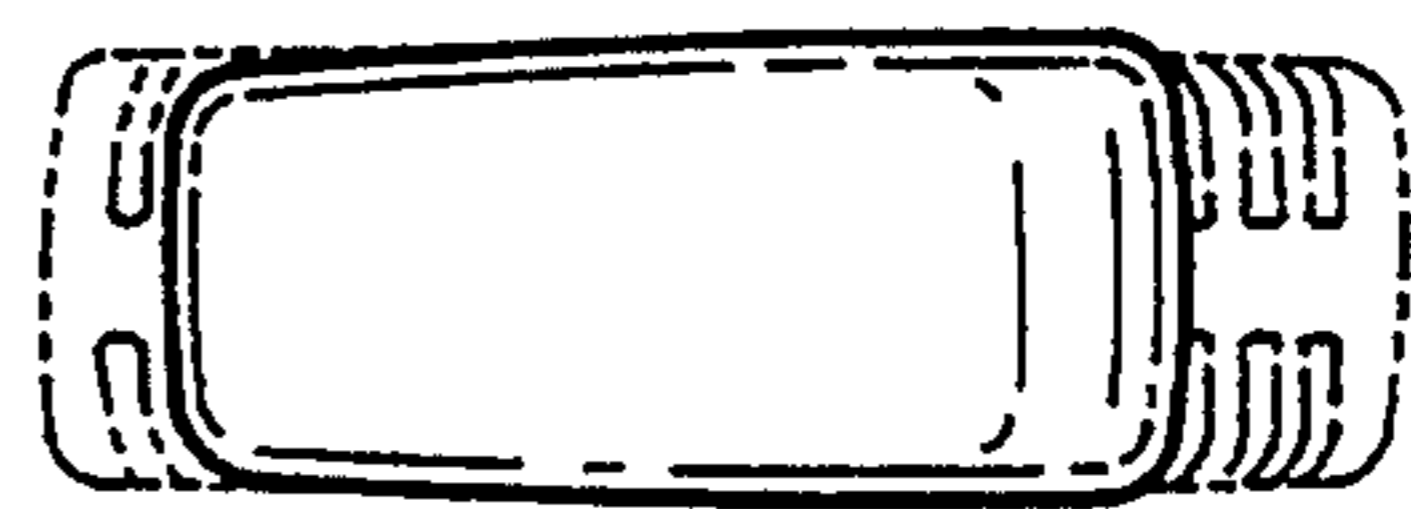

FIG. 9

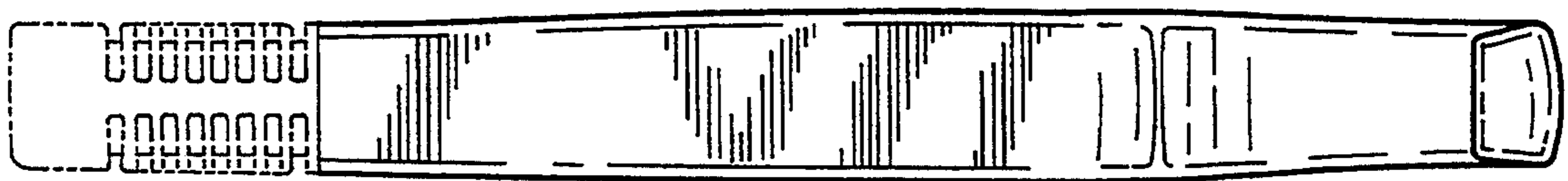

FIG. 10