



US00D352785S

United States Patent [19] Fitzgerald

[11] Patent Number: **Des. 352,785**

[45] Date of Patent: **** Nov. 22, 1994**

[54] **AIR EXTRACTOR FOR A BABY'S BOTTLE**

[76] Inventor: **Stuart M. Fitzgerald, 53 Iroquois Rd., Hartford, Conn. 06117-2112**

[**] Term: **14 Years**

[21] Appl. No.: **9,438**

[22] Filed: **Jun. 14, 1993**

[52] U.S. Cl. **D24/193**

[58] Field of Search **215/11.1, 11.5; D24/197, 193**

4,176,754	12/1979	Miller	215/11 E
4,880,125	11/1989	LeBeau	215/11.3
4,955,493	9/1990	Touzani	215/100
4,979,629	12/1990	Askernese	215/11.1
5,033,631	7/1991	Nightingale	215/11.1

Primary Examiner—Stella Reid
Attorney, Agent, or Firm—C. G. Nessler

[57] **CLAIM**

The ornamental design for an air extractor for a baby's bottle, as shown.

DESCRIPTION

FIG. 1 is a perspective view of an air extractor for a baby's bottle showing my new design;
FIG. 2 is a left side elevational view thereof;
FIG. 3 is a front elevational view thereof;
FIG. 4 is a rear elevational view thereof;
FIG. 5 is a top plan view thereof; and,
FIG. 6 is a bottom plan view thereof.

[56] **References Cited**

U.S. PATENT DOCUMENTS

D. 329,289	9/1992	Bernstein	D24/193
D. 331,111	11/1992	Mazza et al.	D24/193
D. 334,236	3/1993	Turknett	D24/197
D. 338,531	8/1993	Howell	D24/197 X
3,648,873	3/1972	Grobbe	215/11 R

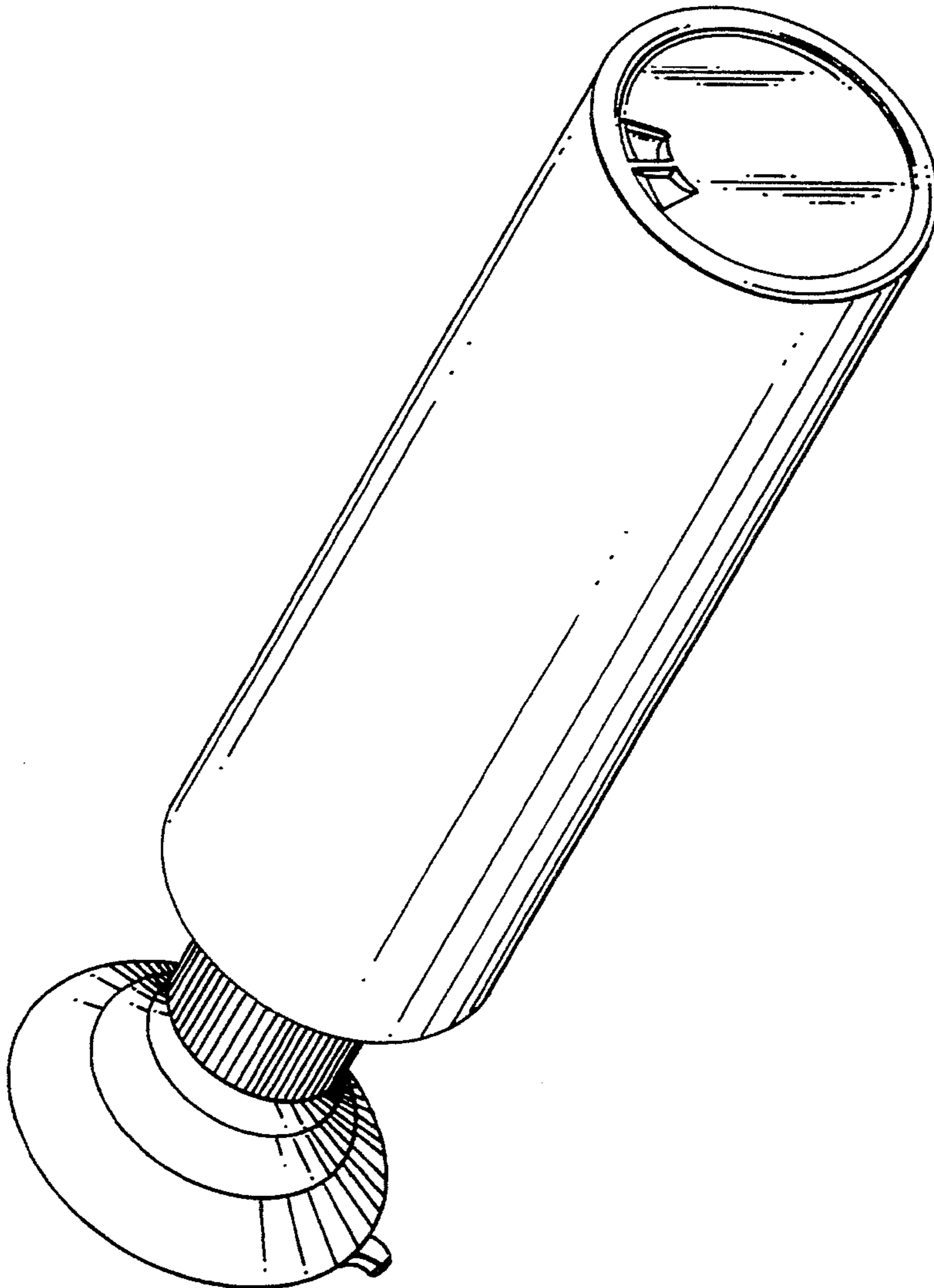

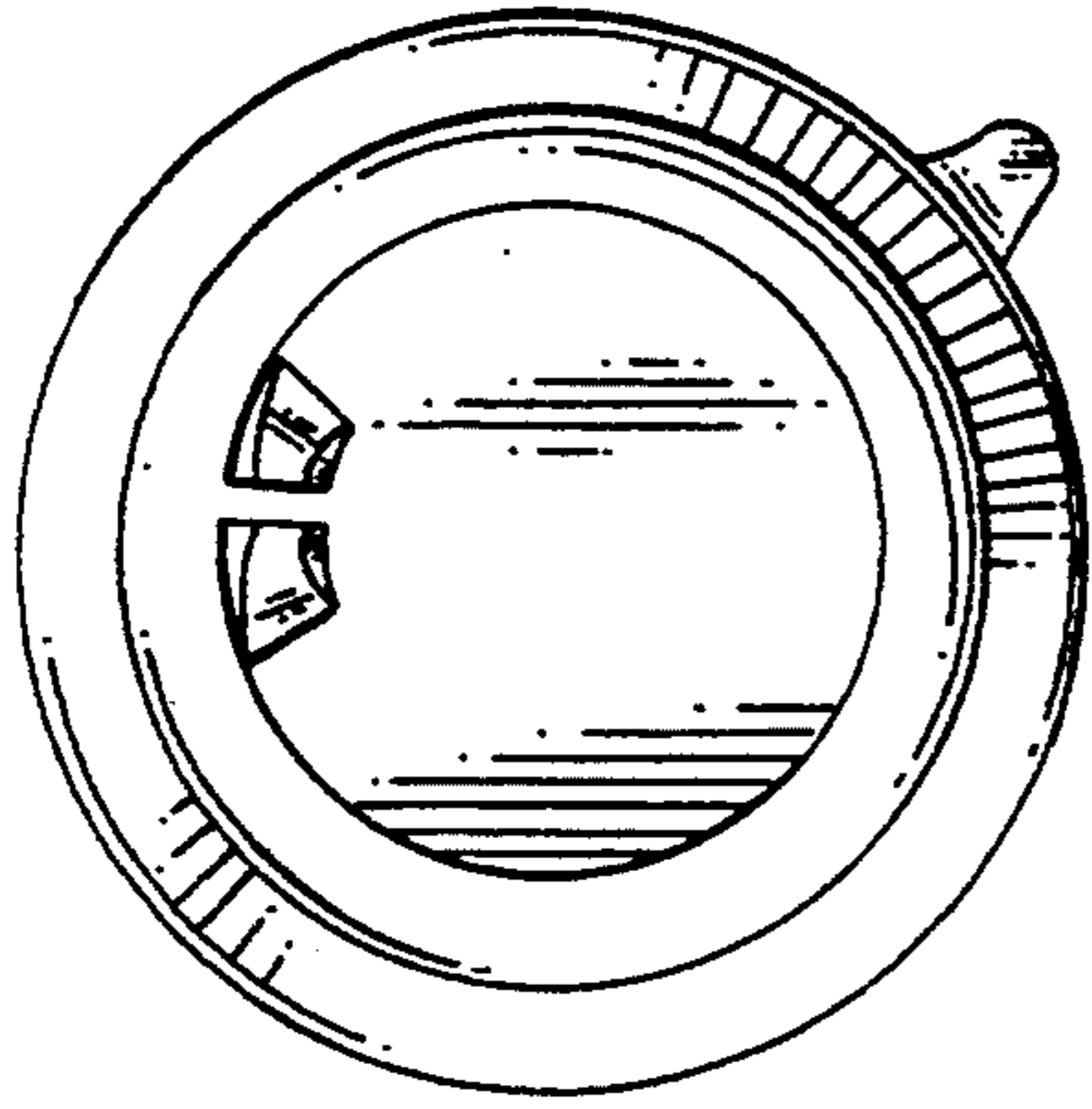

FIG. 5

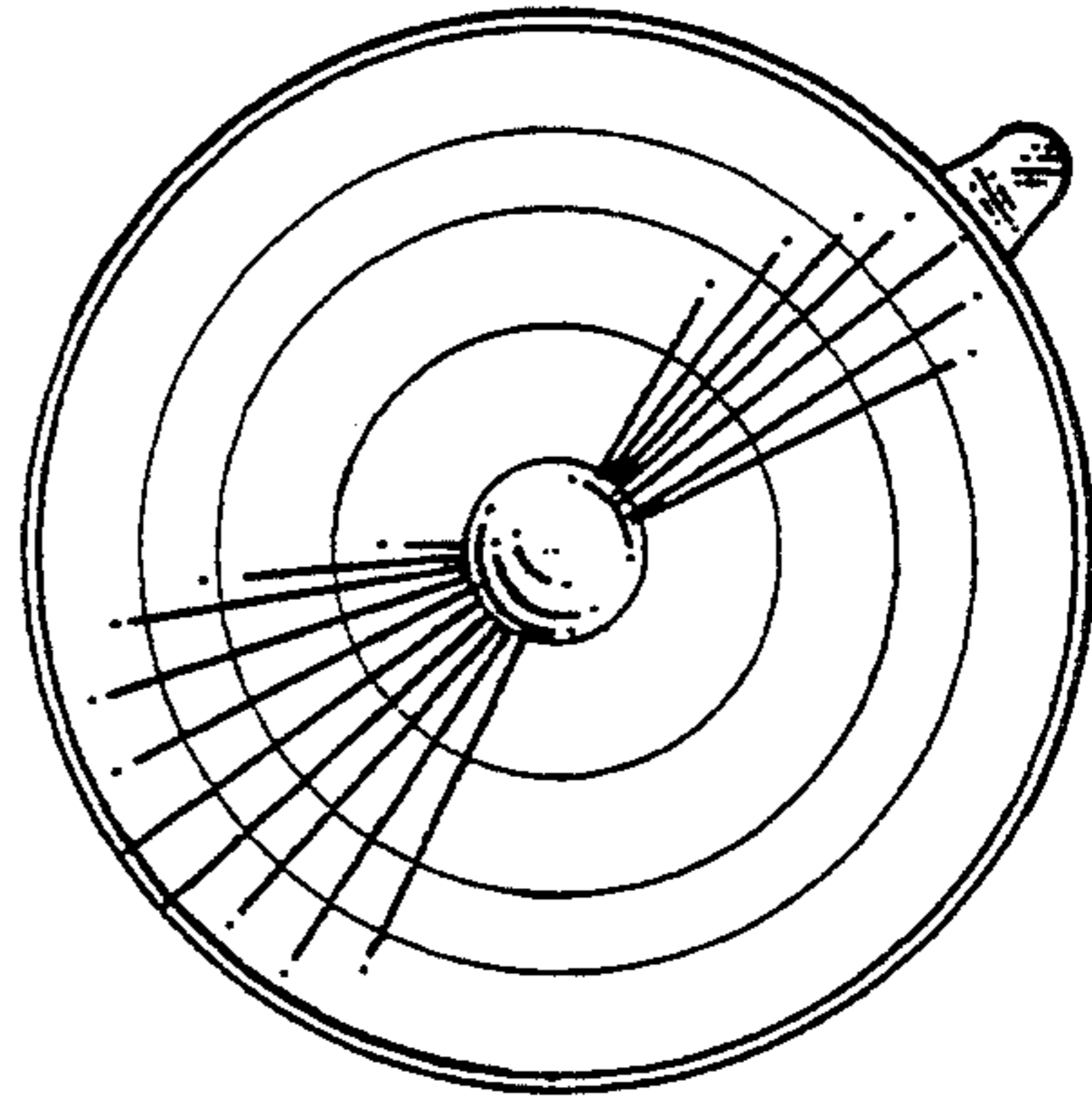

FIG. 6

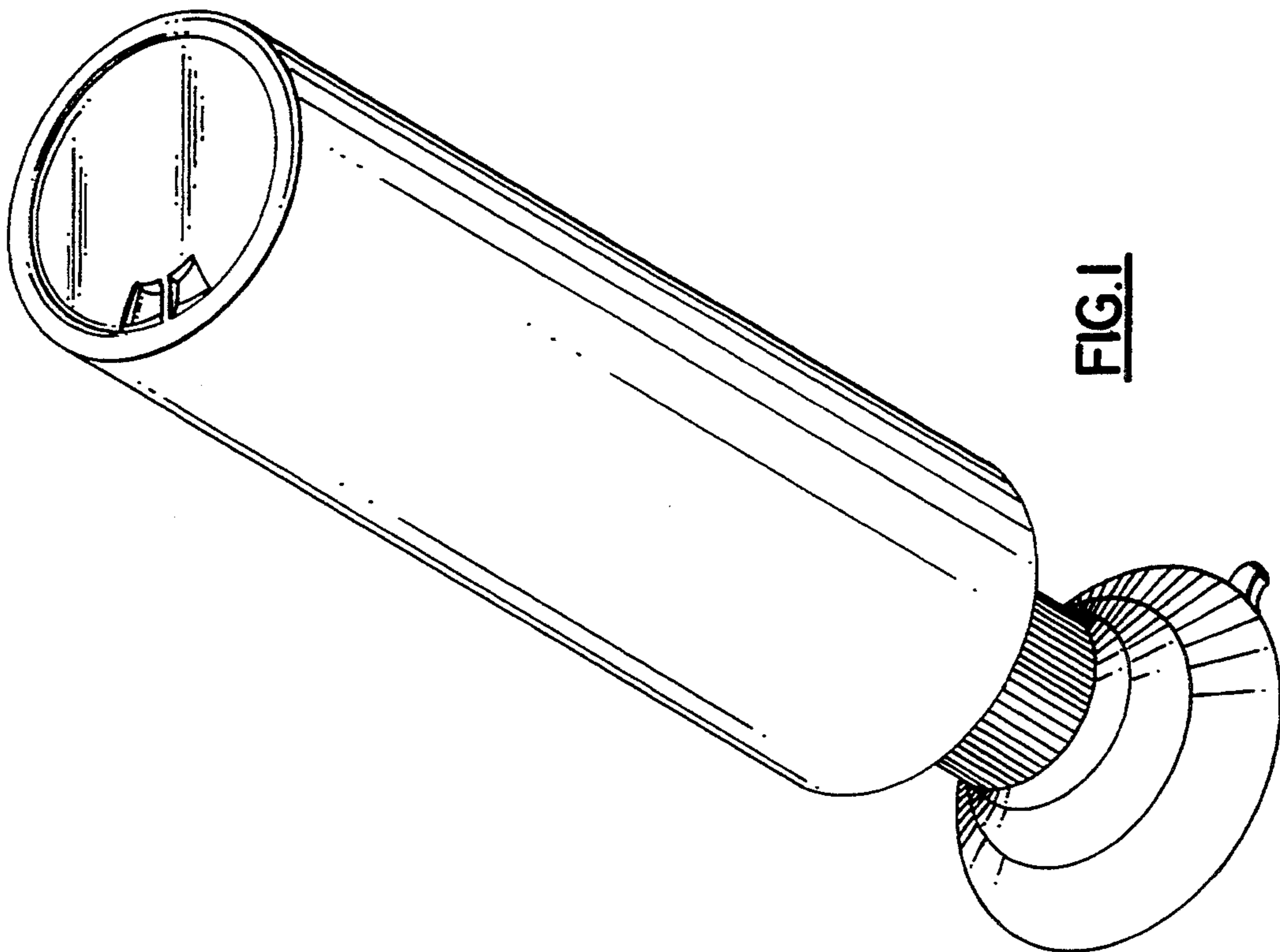

FIG. 1

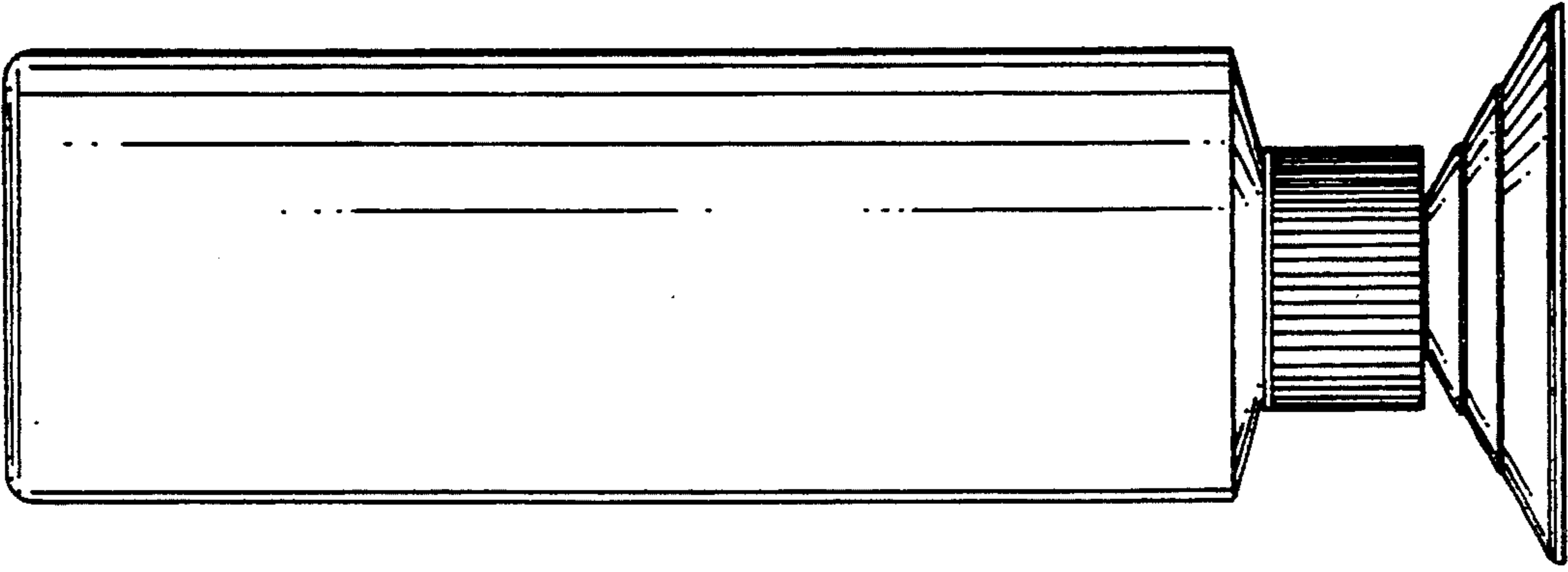

FIG.4

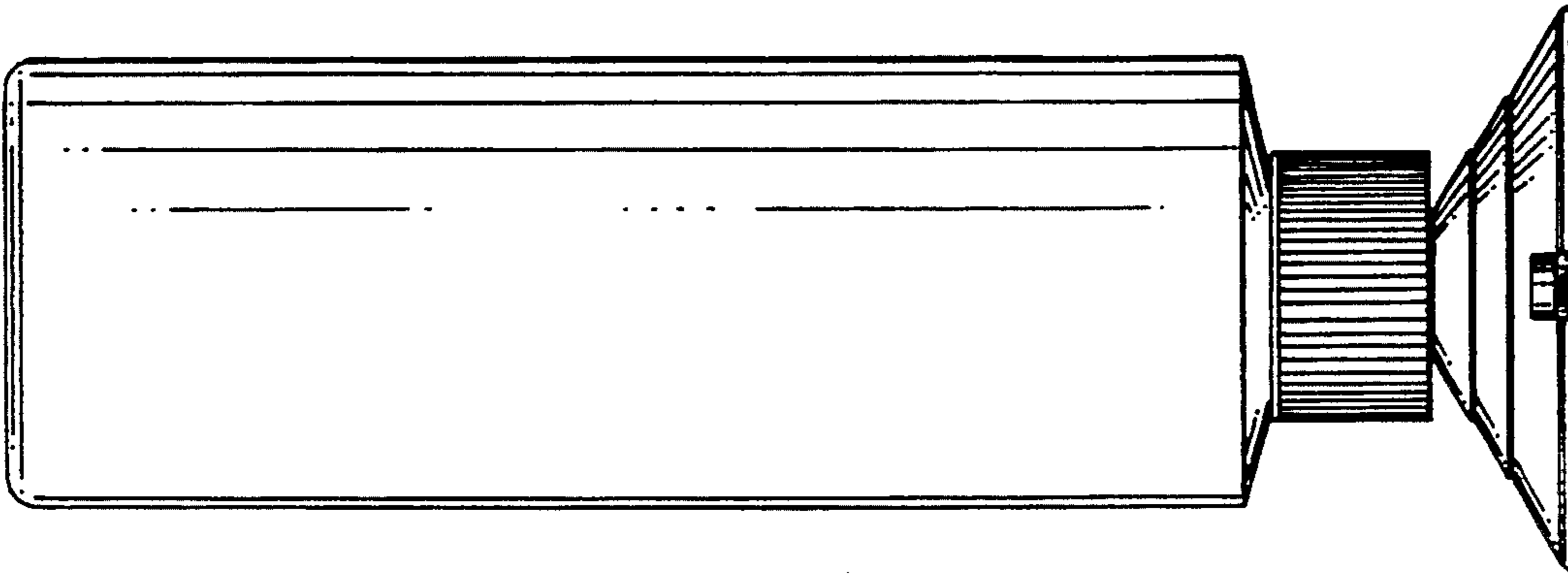

FIG.3

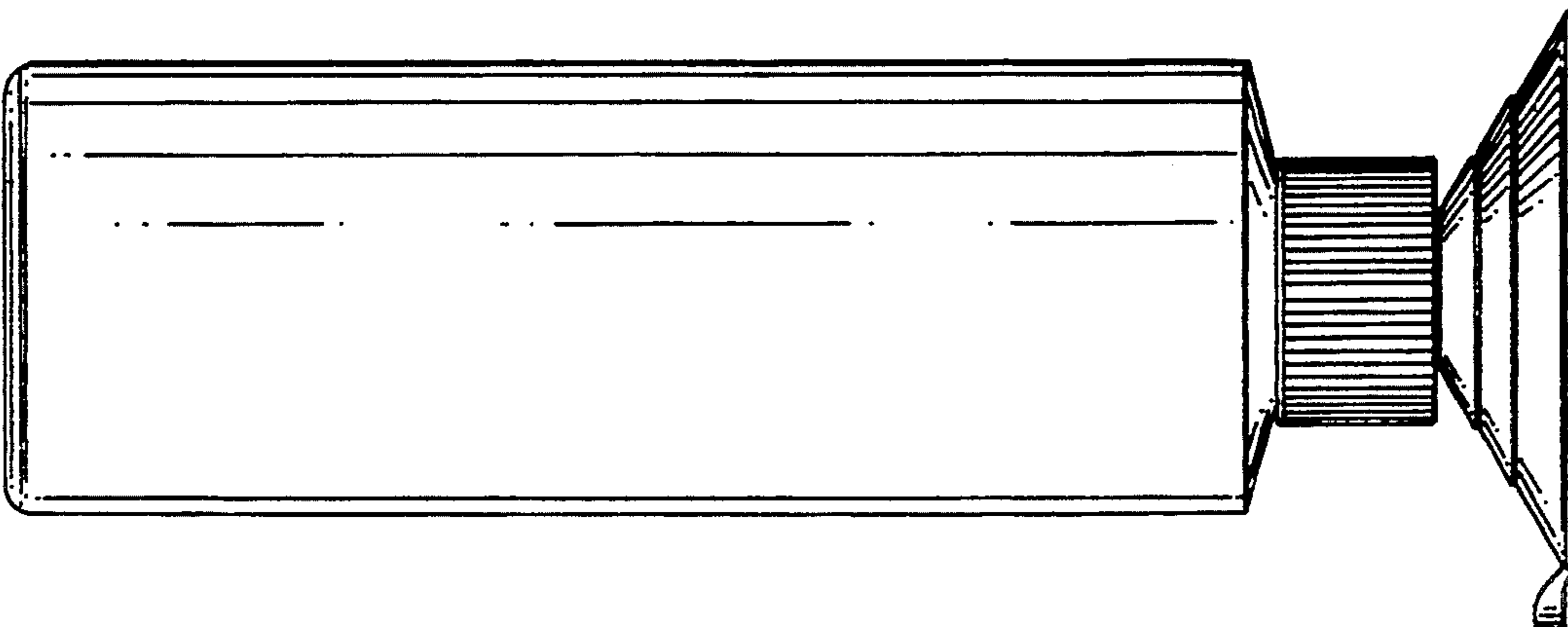

FIG.2