



US00D352782S

# United States Patent [19]

Kirk, III et al.

[11] Patent Number: Des. 352,782

[45] Date of Patent: \*\* Nov. 22, 1994

[54] IONTOPHORETIC DRUG DELIVERY SYSTEM

4,708,716	11/1987	Sibalis	604/20
5,088,978	2/1992	Hillman et al.	604/20
5,256,137	10/1993	Sage, Jr.	604/20

[75] Inventors: Karl D. Kirk, III, New York, N.Y.; James R. Toleman, Palo Alto, Calif.

Primary Examiner—Stella Reid  
Attorney, Agent, or Firm—Allen W. Wark

[73] Assignee: Becton Dickinson and Company, Franklin Lakes, N.J.

[57] CLAIM

[\*\*] Term: 14 Years

The ornamental design for the iontophoretic drug delivery system, as shown.

[21] Appl. No.: 12,328

DESCRIPTION

[22] Filed: Aug. 30, 1993

[52] U.S. Cl. .... D24/189

[58] Field of Search ..... 604/304, 306, 307, 20; D24/189

FIG. 1 is a top perspective view of an iontophoretic drug delivery system, showing our new design;  
 FIG. 2 is a top plan view thereof;  
 FIG. 3 is a side elevational view thereof;  
 FIG. 4 is an end elevational view thereof; the opposite end elevational view being substantially identical thereto;  
 FIG. 5 is a rear elevational view thereof;  
 FIG. 6 is a bottom plan view thereof; and,  
 FIG. 7 is an exploded perspective view thereof.

[56] References Cited

U.S. PATENT DOCUMENTS

D. 296,006	5/1988	Asche	D24/189
4,416,274	11/1983	Jacobsen et al.	604/20

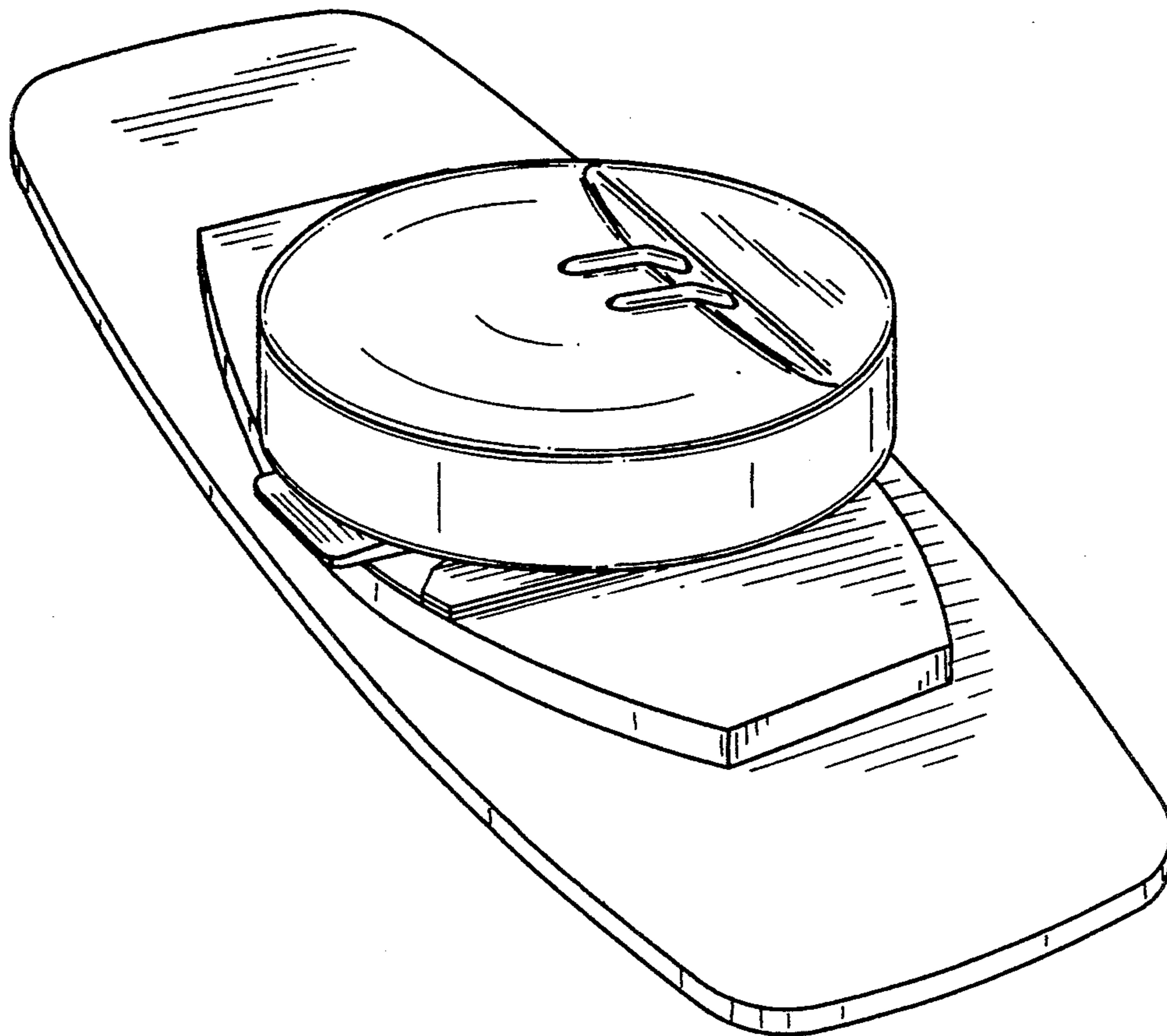

FIG-1

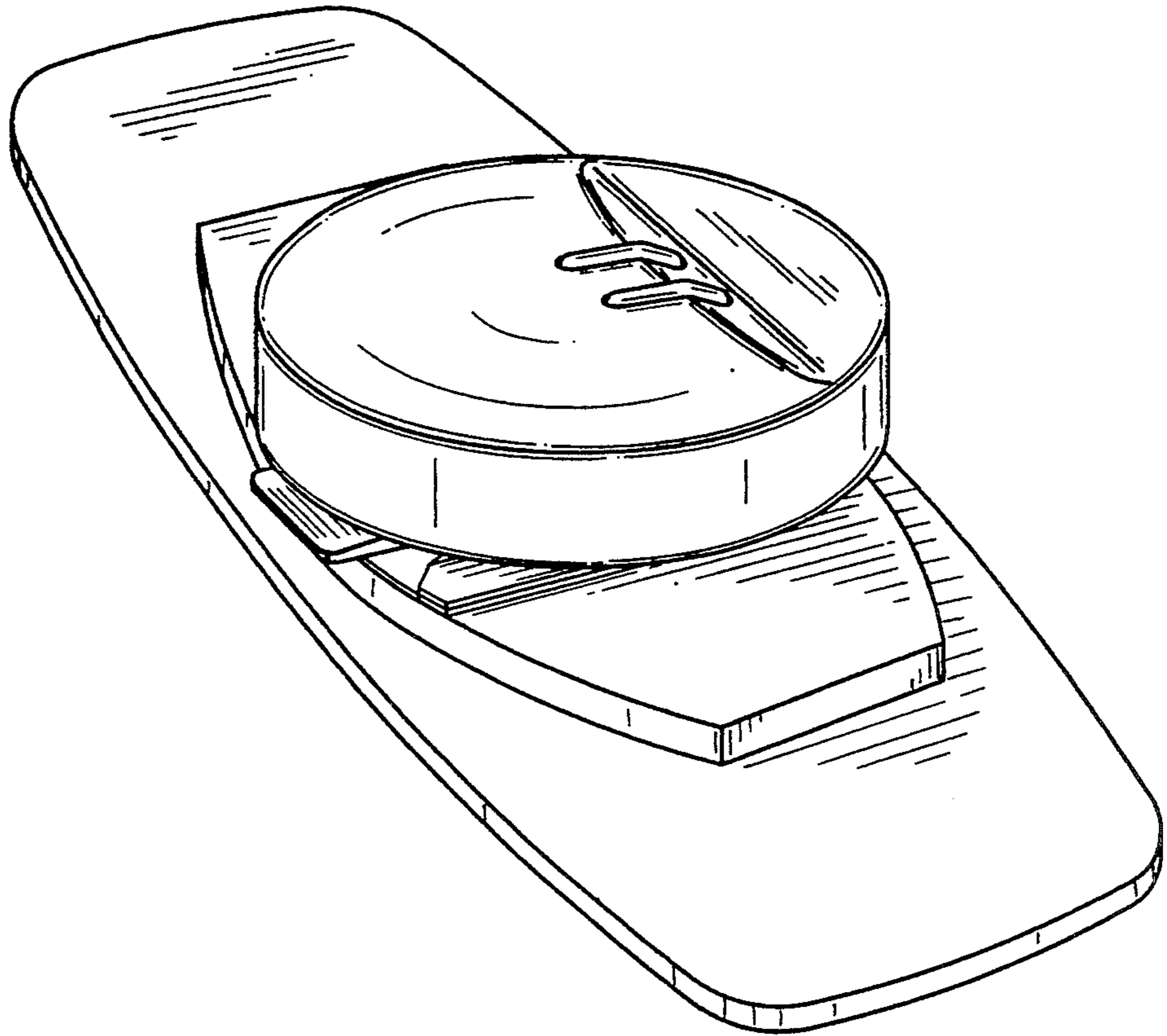

FIG-2

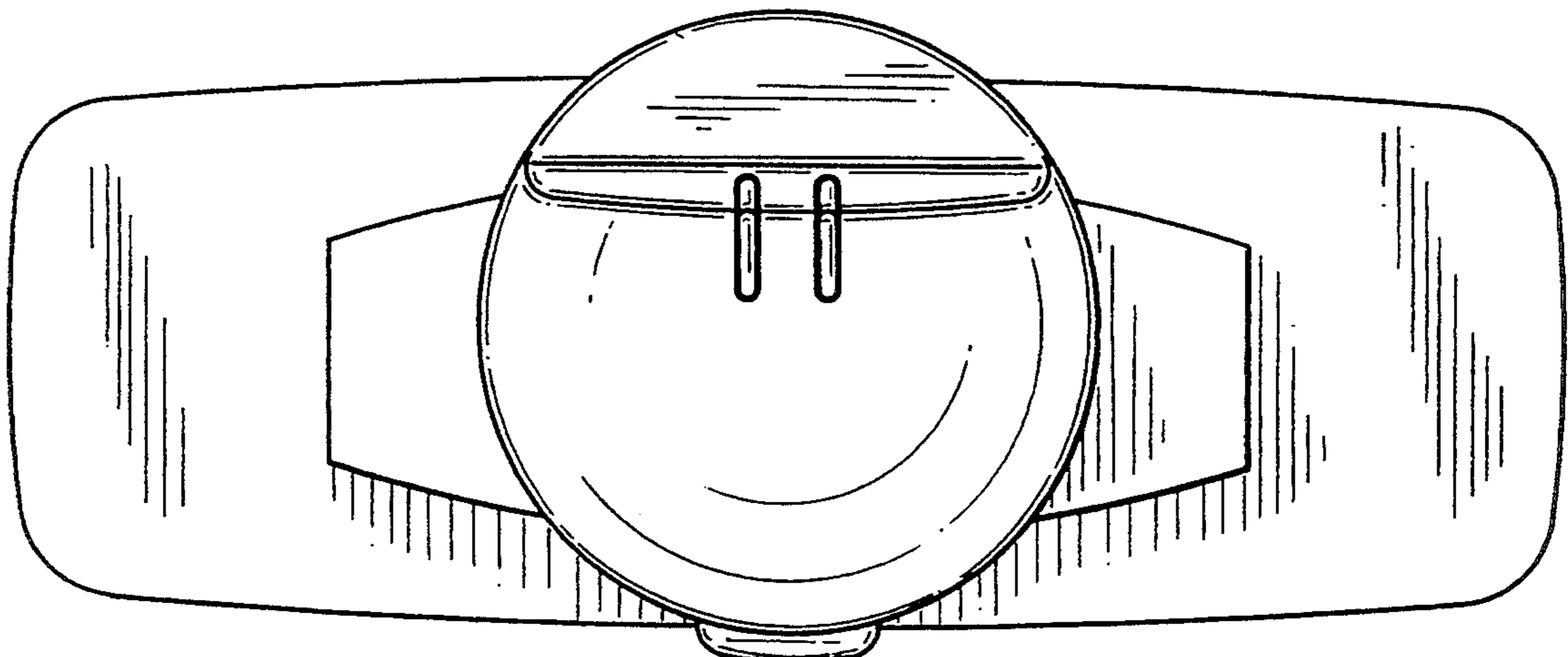

FIG-3

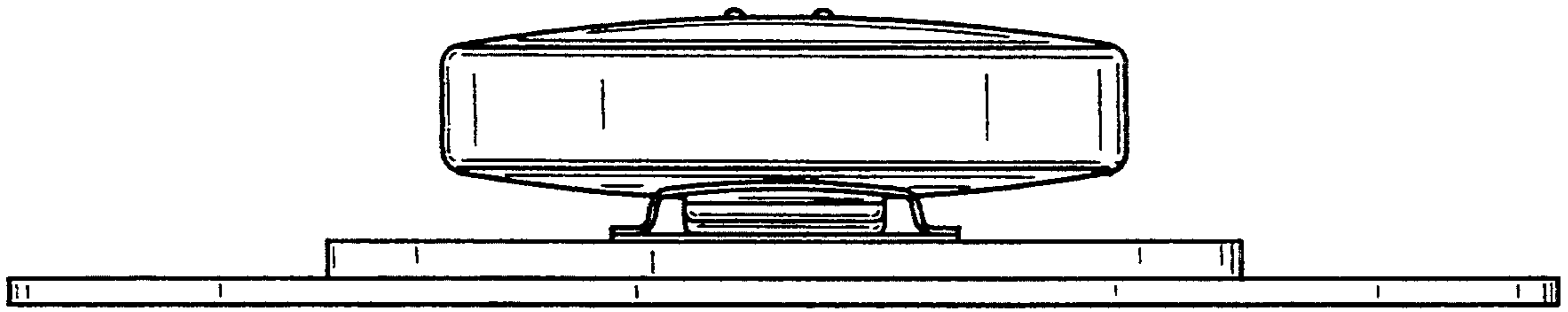

FIG-4

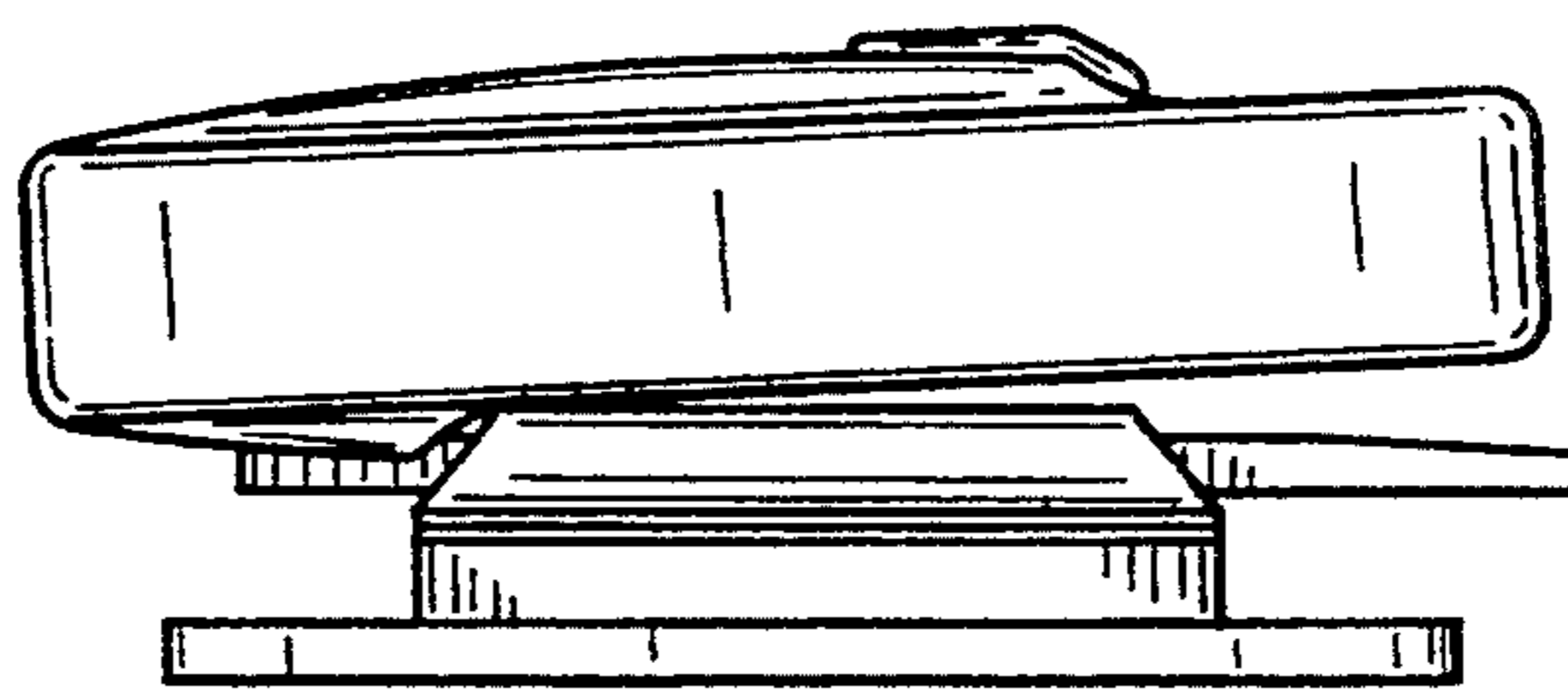

FIG-5

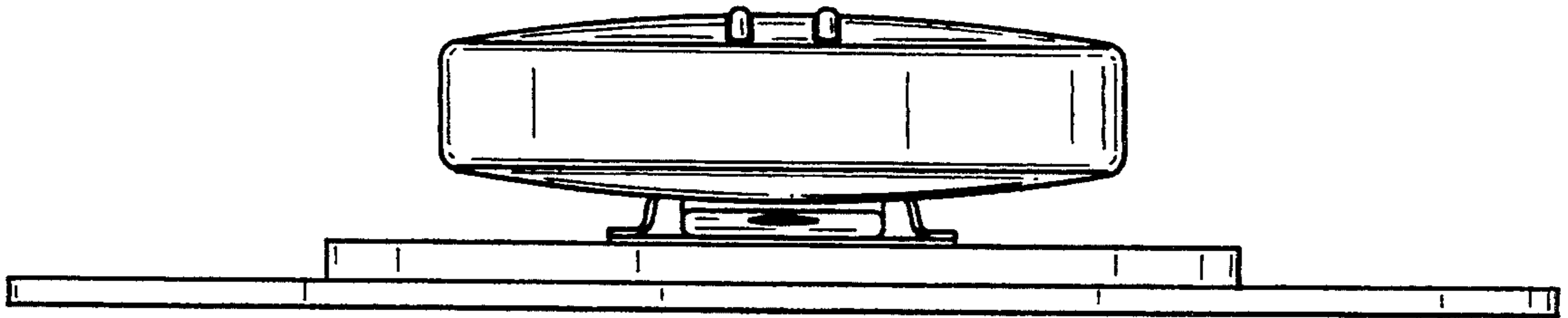

FIG-6

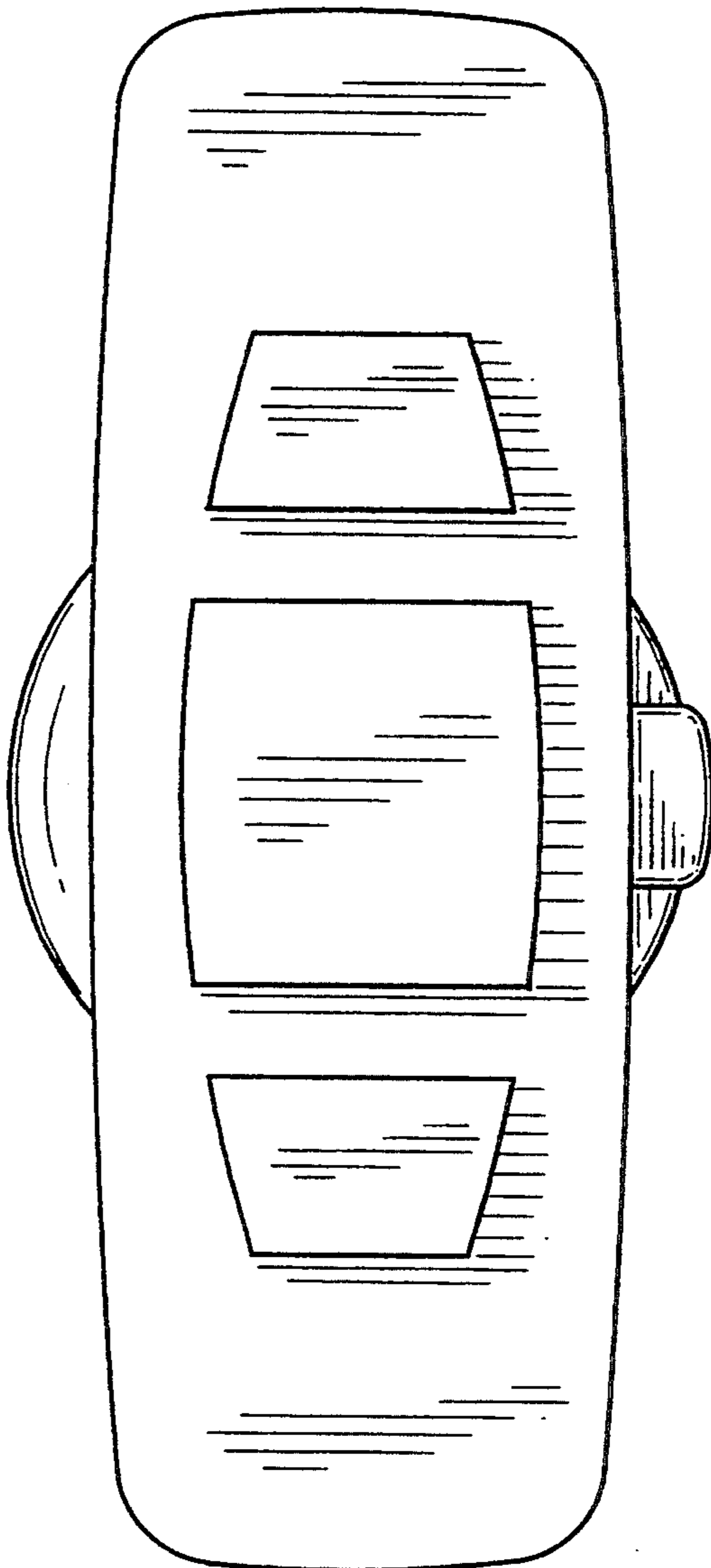

FIG-7

