



US00D352658S

United States Patent [19]
Yan

[11] **Patent Number: Des. 352,658**
[45] **Date of Patent: ** Nov. 22, 1994**

[54] **BOTTLE OF CYANOACRYLATE ADHESIVE**

[76] **Inventor: Yi-Tsung Yan, P.O. Box 96-405, Taipei 10098,**

[**] **Term: 14 Years**

[21] **Appl. No.: 7,022**

[22] **Filed: Apr. 14, 1993**

[52] **U.S. Cl. D9/337; D9/521**

[58] **Field of Search D9/337, 516, 517, 520, D9/521, 549, 558, 569, 571-575; 401/9, 16, 18, 26, 123, 183, 191, 195, 202-207, 262-265; D23/366, 369; D24/112-114, 130**

[56] **References Cited**

U.S. PATENT DOCUMENTS

- D. 22,357 4/1893 Hall D9/302
- D. 127,714 6/1911 Hansen D9/558
- D. 165,591 1/1952 Lee D24/112
- D. 266,702 10/1982 Lagny D9/558 X
- D. 272,849 2/1984 Bel et al. D24/112 X
- D. 273,764 5/1984 Steigerwald et al. D9/529 X

- D. 281,223 11/1985 Dearing D9/529 X
- D. 288,780 3/1987 Miller D9/337
- D. 313,087 12/1990 Bloom D9/337 X
- D. 334,979 4/1993 Smith D24/130
- 4,376,495 3/1983 Spatz 222/92 X

Primary Examiner—Bernard Ansher
Assistant Examiner—Mitchell I. Siegel

[57] **CLAIM**

The ornamental design for a bottle of cyanoacrylate adhesive, as shown and described.

DESCRIPTION

FIG. 1 is an perspective view of a bottle of cyanoacrylate adhesive showing my new design;
 FIG. 2 is a exploded perspective view thereof;
 FIG. 3 is a right side elevational view of FIG. 1;
 FIG. 4 is a front elevational view of FIG. 1;
 FIG. 5 is a left side elevational view of FIG. 1;
 FIG. 6 is a rear elevational view of FIG. 1;
 FIG. 7 is a top plan view of FIG. 1 and,
 FIG. 8 is a bottom plan view of FIG. 1.

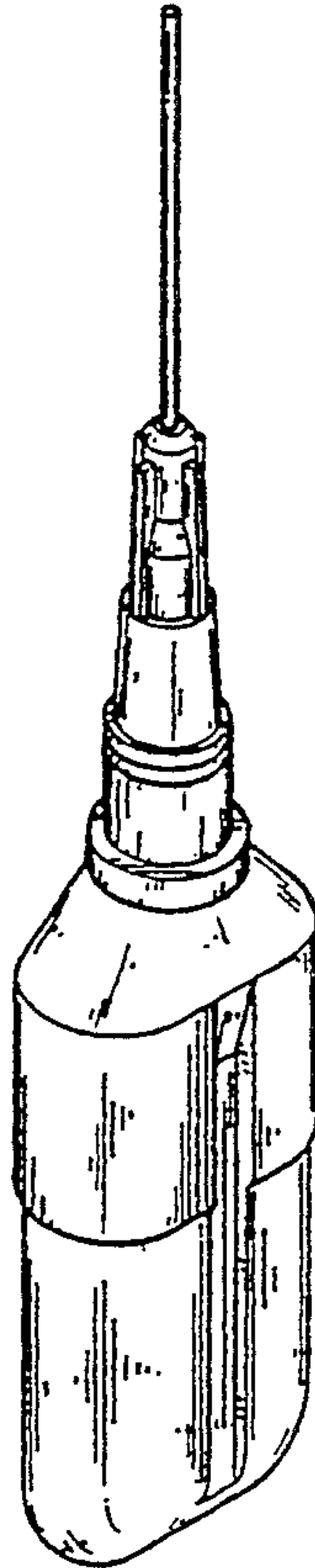

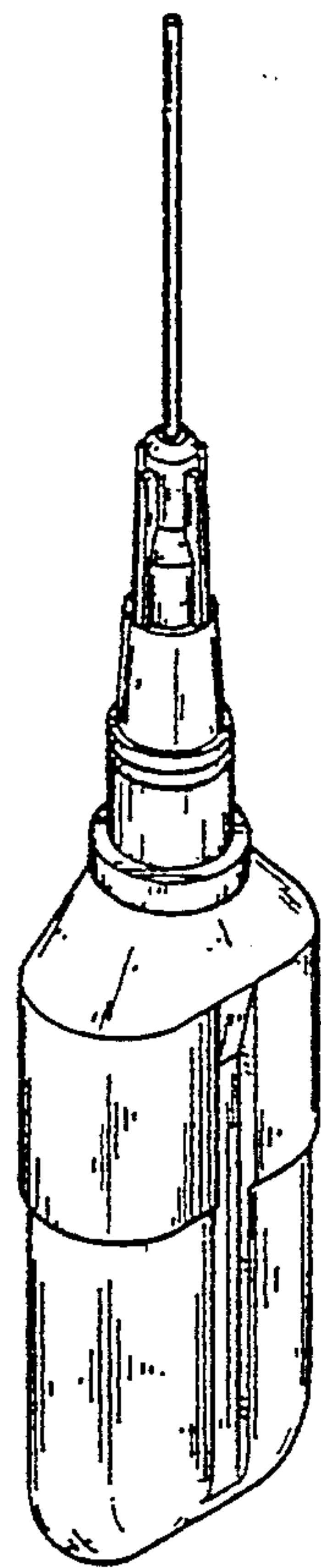

FIG. 1

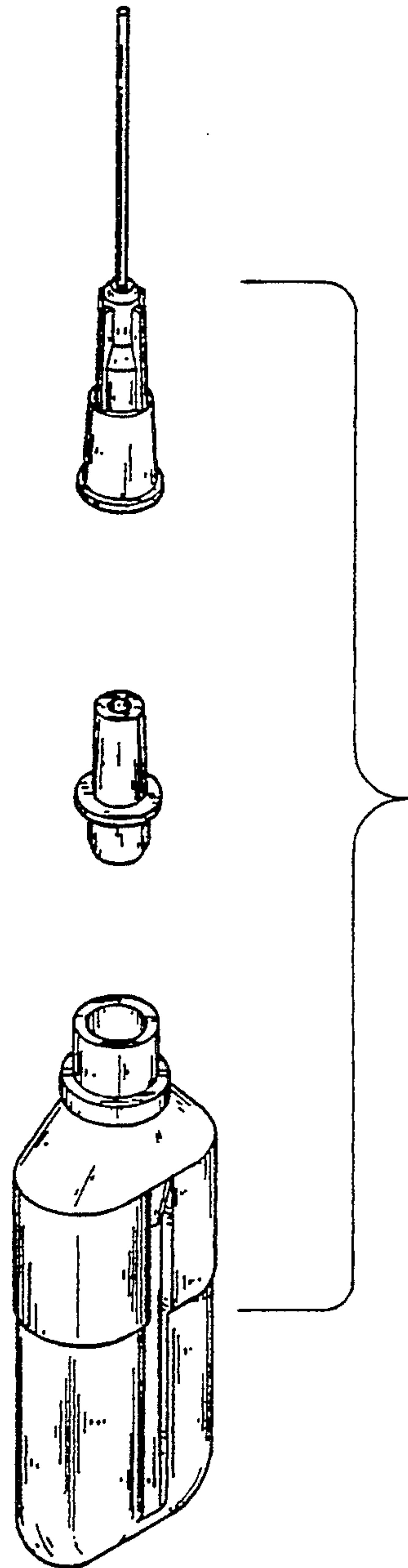

FIG. 2



FIG. 3

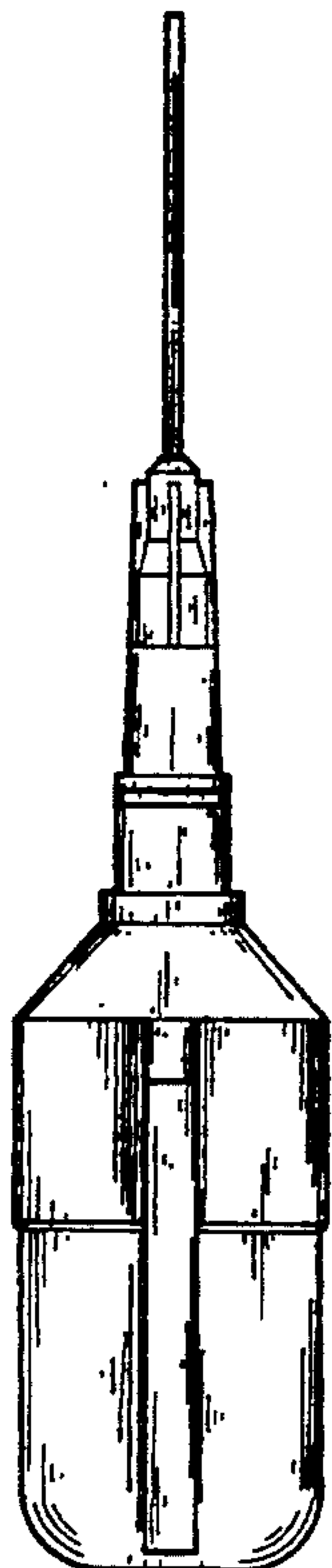

FIG. 4

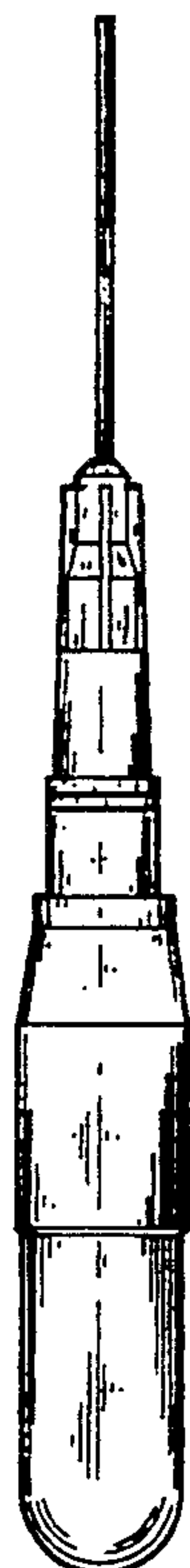

FIG. 5

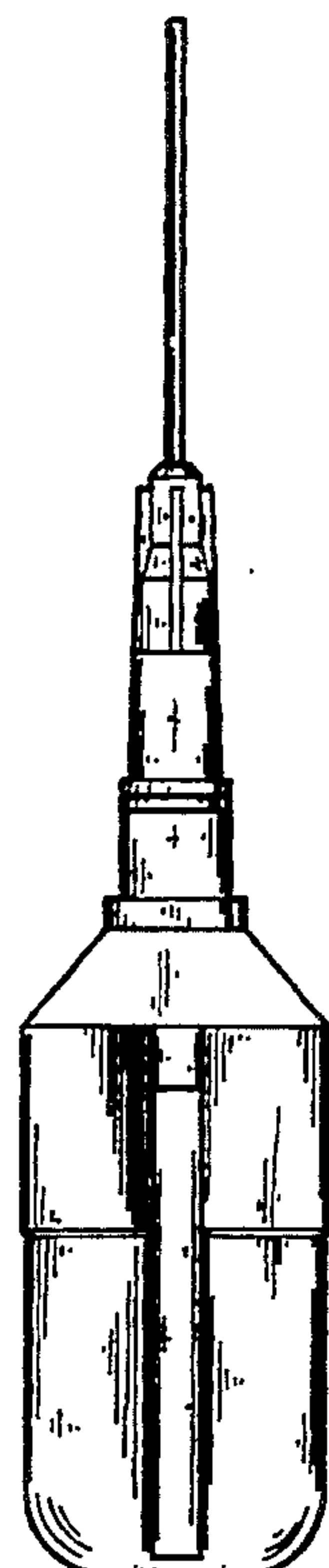

FIG. 6

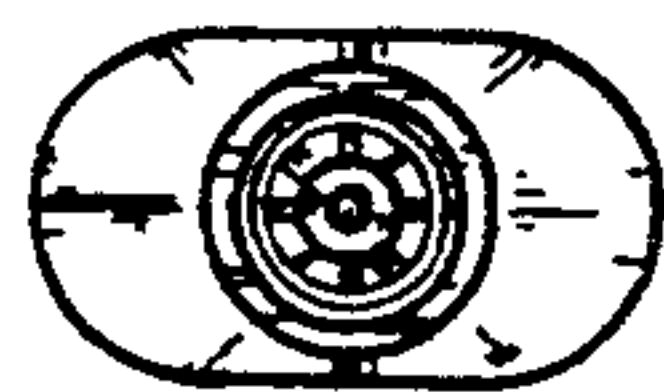

FIG. 7



FIG. 8