



US00D352600S

# United States Patent [19]

[11] Patent Number: Des. 352,600

Steeley

[45] Date of Patent: \*\* Nov. 22, 1994

[54] **KEY HOLDER**

[76] Inventor: **Larry J. Steeley**, 6004 Brookhill Cir., Birmingham, Ala. 35242

[\*\*] Term: **14 Years**

[21] Appl. No.: **6,161**

[22] Filed: **Mar. 22, 1993**

[52] U.S. Cl. .... **D3/208; D3/207**

[58] Field of Search ..... **D3/207-212, D3/103, 61-65; 70/456 R, 456 B, 457, 458, 459, 460; 24/3 K**

[56] **References Cited**

**U.S. PATENT DOCUMENTS**

D. 210,800	4/1968	Brinkman	.....	D3/61
D. 248,190	6/1978	Motzer	.....	D3/61
D. 276,096	10/1984	Brentini	.....	D3/61
D. 277,338	1/1985	Cuttler	.....	D3/61
2,883,851	4/1959	Gold	.....	D3/61

*Primary Examiner*—Ralf T. Seifert  
*Attorney, Agent, or Firm*—Veal & Associates

[57] **CLAIM**

The ornamental design for a key holder, as shown and described.

**DESCRIPTION**

FIG. 1 is a front perspective view of a showing my new design;  
 FIG. 2 is a rear perspective view thereof;  
 FIG. 3 is a bottom perspective view thereof;  
 FIG. 4 is a front elevational view thereof;  
 FIG. 5 is a rear elevational view thereof;  
 FIG. 6 is a top plan view thereof;  
 FIG. 7 is a bottom view thereof;  
 FIG. 8 is a side elevational view thereof;  
 FIG. 9 is a side elevational view of the side opposite that shown in FIG. 8;  
 FIG. 10 is a front perspective view of the present invention shown in an open position and with a portion of a

key shown in broken lines to illustrate environmental structure;  
 FIG. 11 is a front perspective view of second embodiment;  
 FIG. 12 is a rear perspective view thereof;  
 FIG. 13 is a bottom perspective view thereof;  
 FIG. 14 is a front elevational view thereof;  
 FIG. 15 is a rear elevational view thereof;  
 FIG. 16 is a top plan view thereof;  
 FIG. 17 is a bottom view thereof;  
 FIG. 18 is a side elevational view thereof, the side not shown being identical to the side shown;  
 FIG. 19 is a perspective view of the embodiment shown in FIGS. 11-18 in an open position with a portion of a key shown in broken lines to illustrate environmental structure;  
 FIG. 20 is a front perspective view of a third embodiment;  
 FIG. 21 is a rear perspective view thereof;  
 FIG. 22 is a bottom perspective view thereof;  
 FIG. 23 is a front elevational view thereof;  
 FIG. 24 is a rear elevational view thereof;  
 FIG. 25 is a top plan view thereof;  
 FIG. 26 is a bottom view thereof;  
 FIG. 27 is a side elevational view as seen from the left side of FIG. 23;  
 FIG. 28 is a side elevational view as seen from the right side of FIG. 23;  
 FIG. 29 is a front perspective view of the embodiment shown in FIGS. 20-28 in an open position with a portion of a key shown in broken lines to illustrate environmental structure;  
 FIG. 30 is a front perspective view of a fourth embodiment;  
 FIG. 31 is a rear perspective view thereof;  
 FIG. 32 is a bottom perspective view thereof;  
 FIG. 33 is a front elevational view thereof;  
 FIG. 34 is a rear elevational view thereof;  
 FIG. 35 is a top plan view thereof;  
 FIG. 36 is a bottom view thereof;  
 FIG. 37 is a side elevational view thereof; and,  
 FIG. 38 is a front perspective view of the embodiment shown in FIGS. 30-37 in an open position.

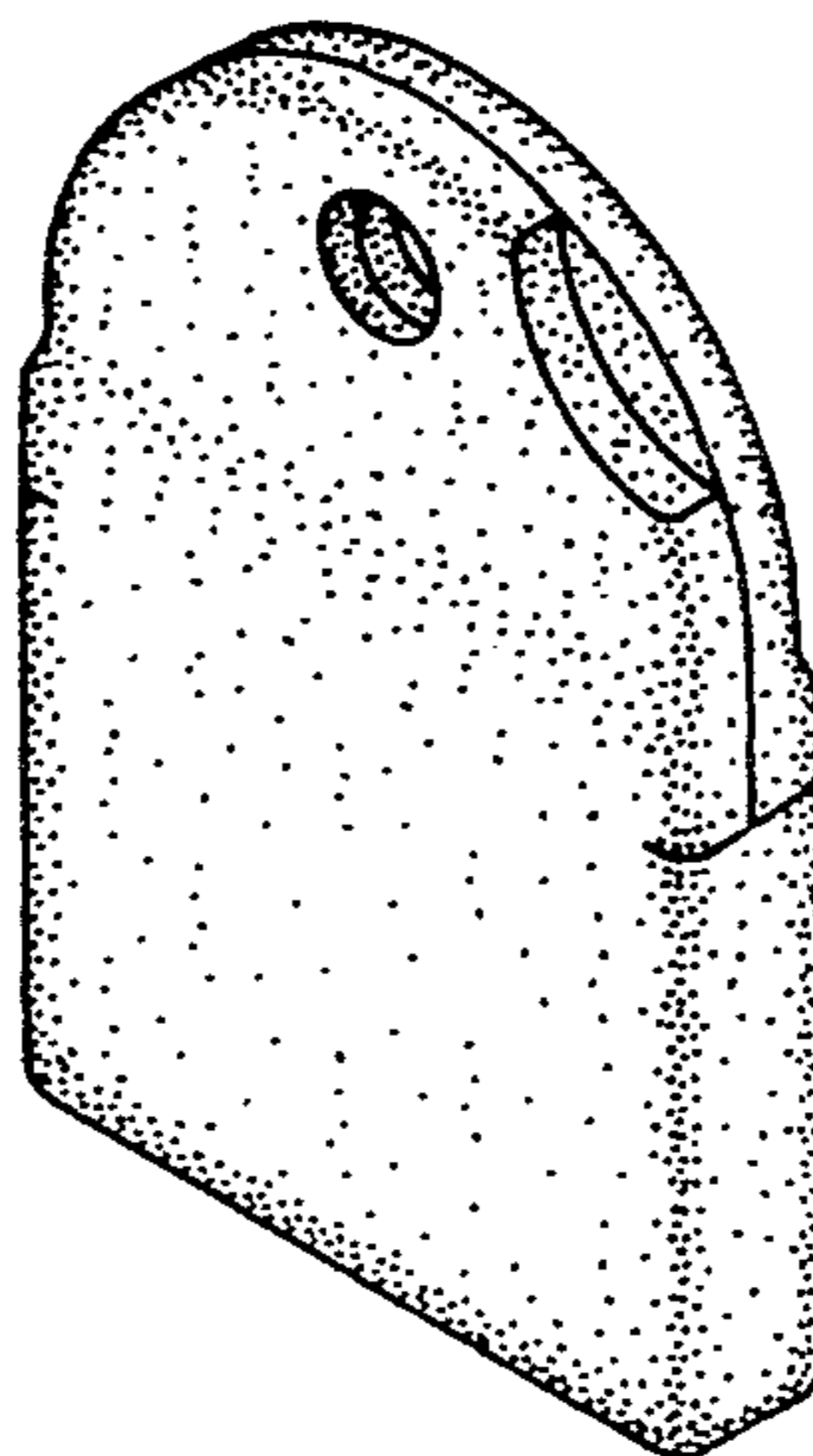

Fig. 1

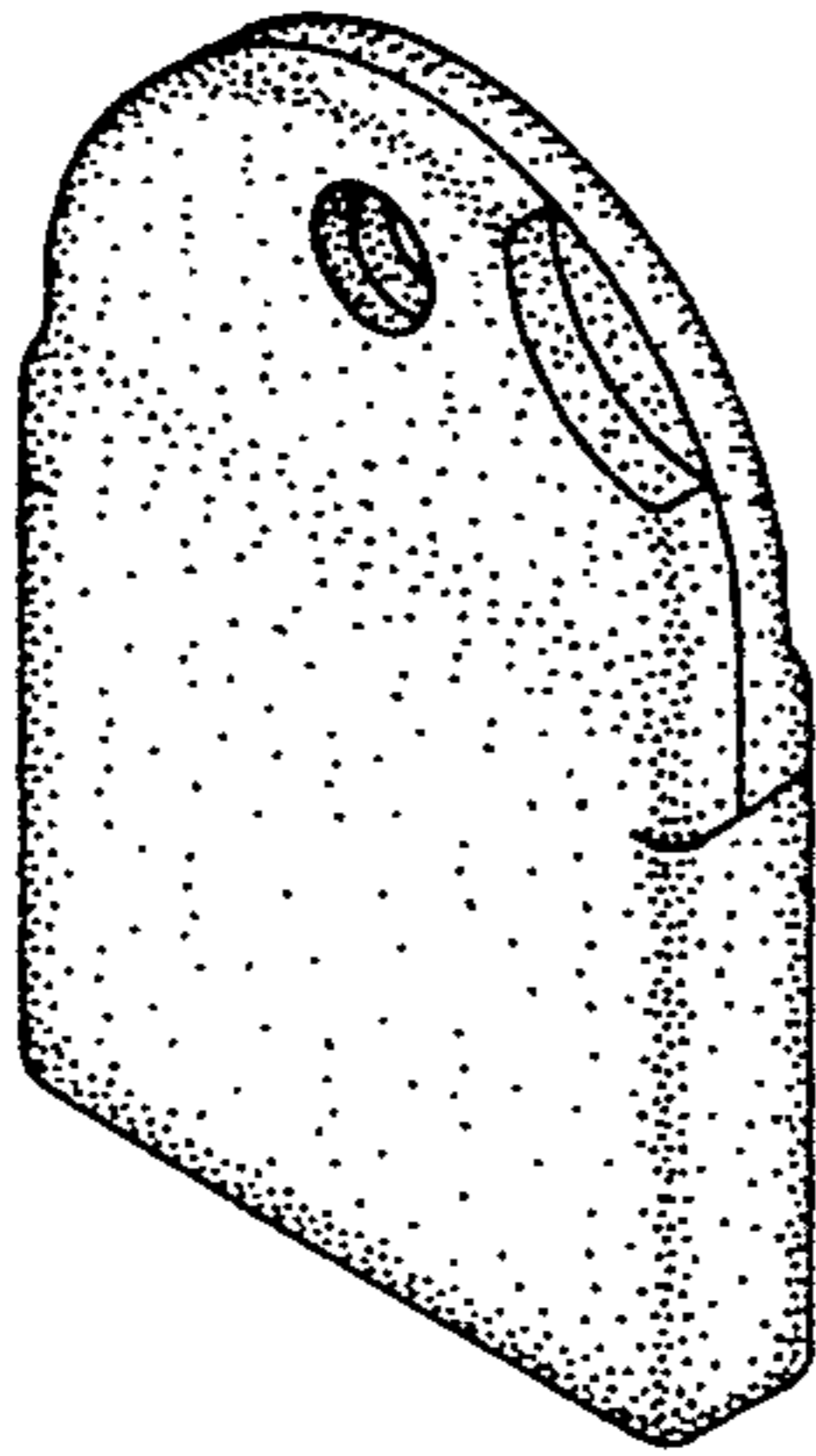

Fig. 2

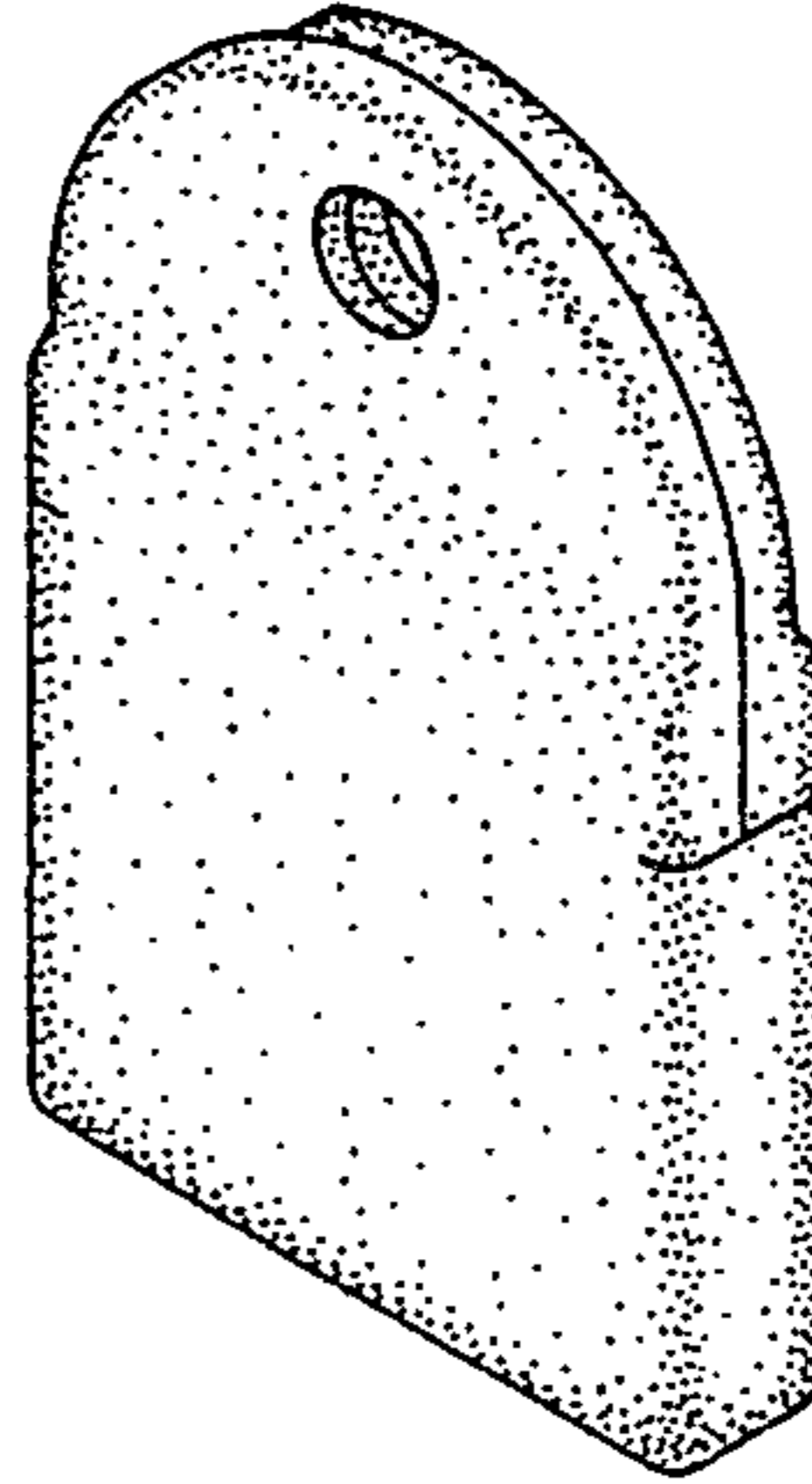

Fig. 3

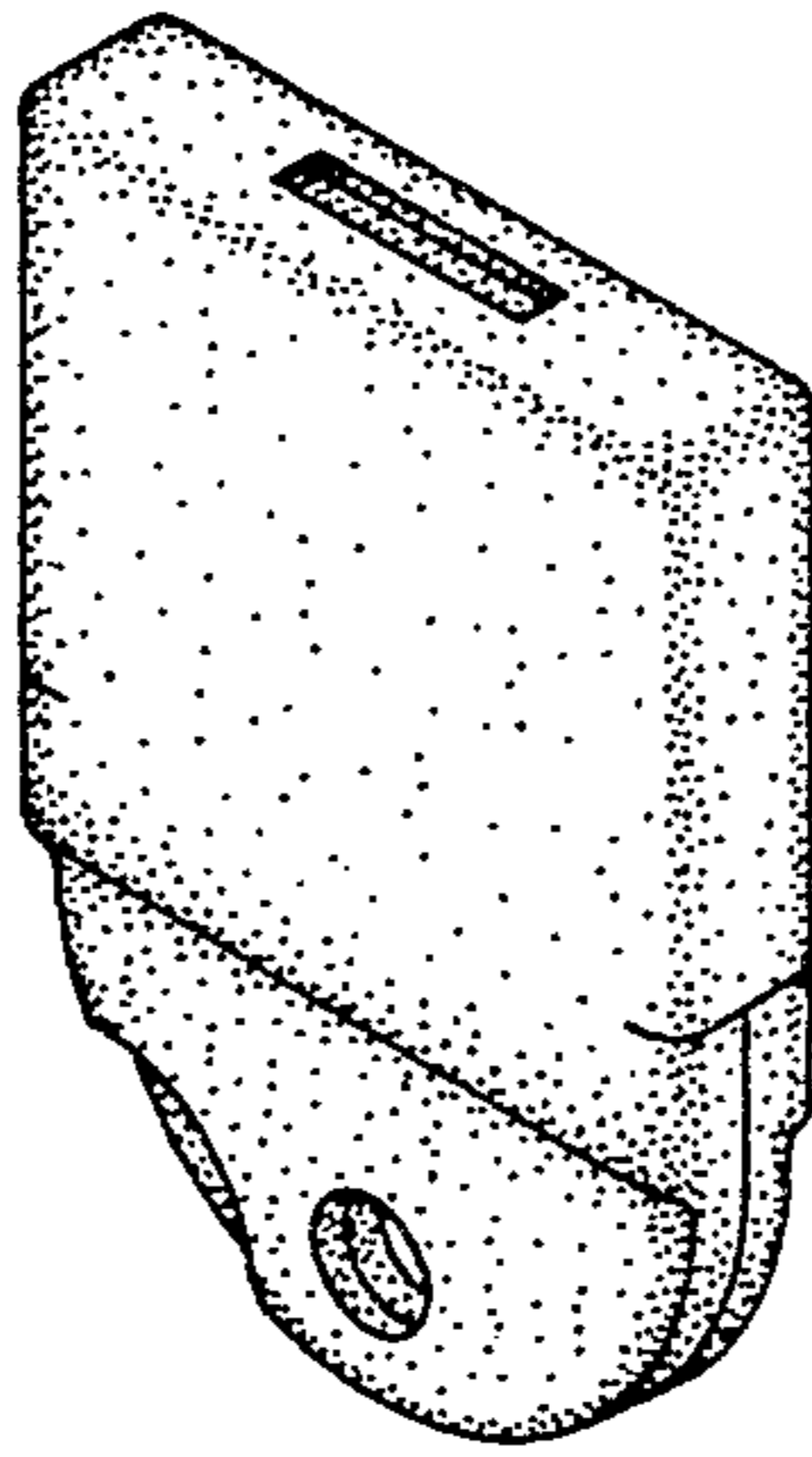

Fig. 4

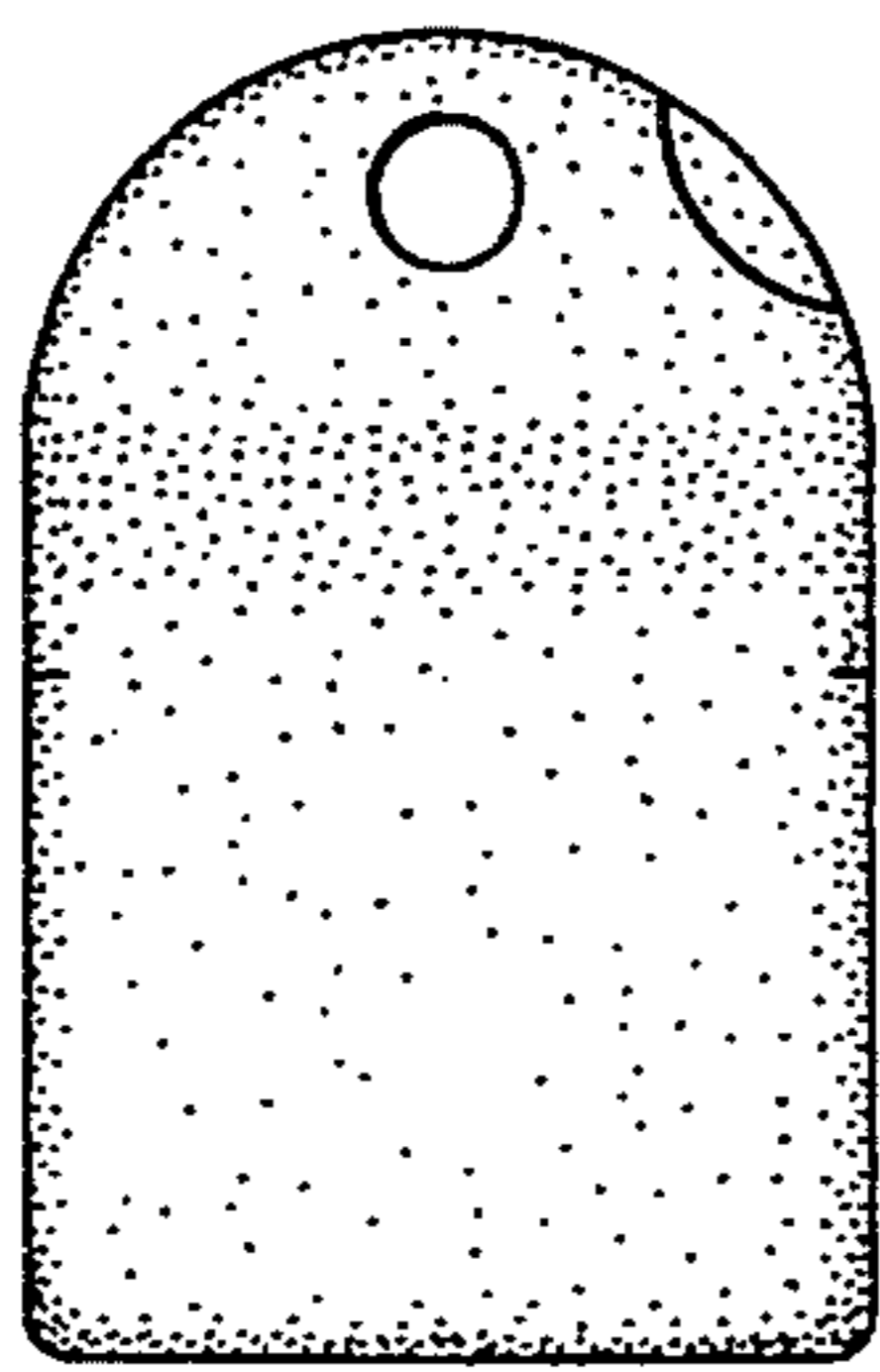

Fig. 5

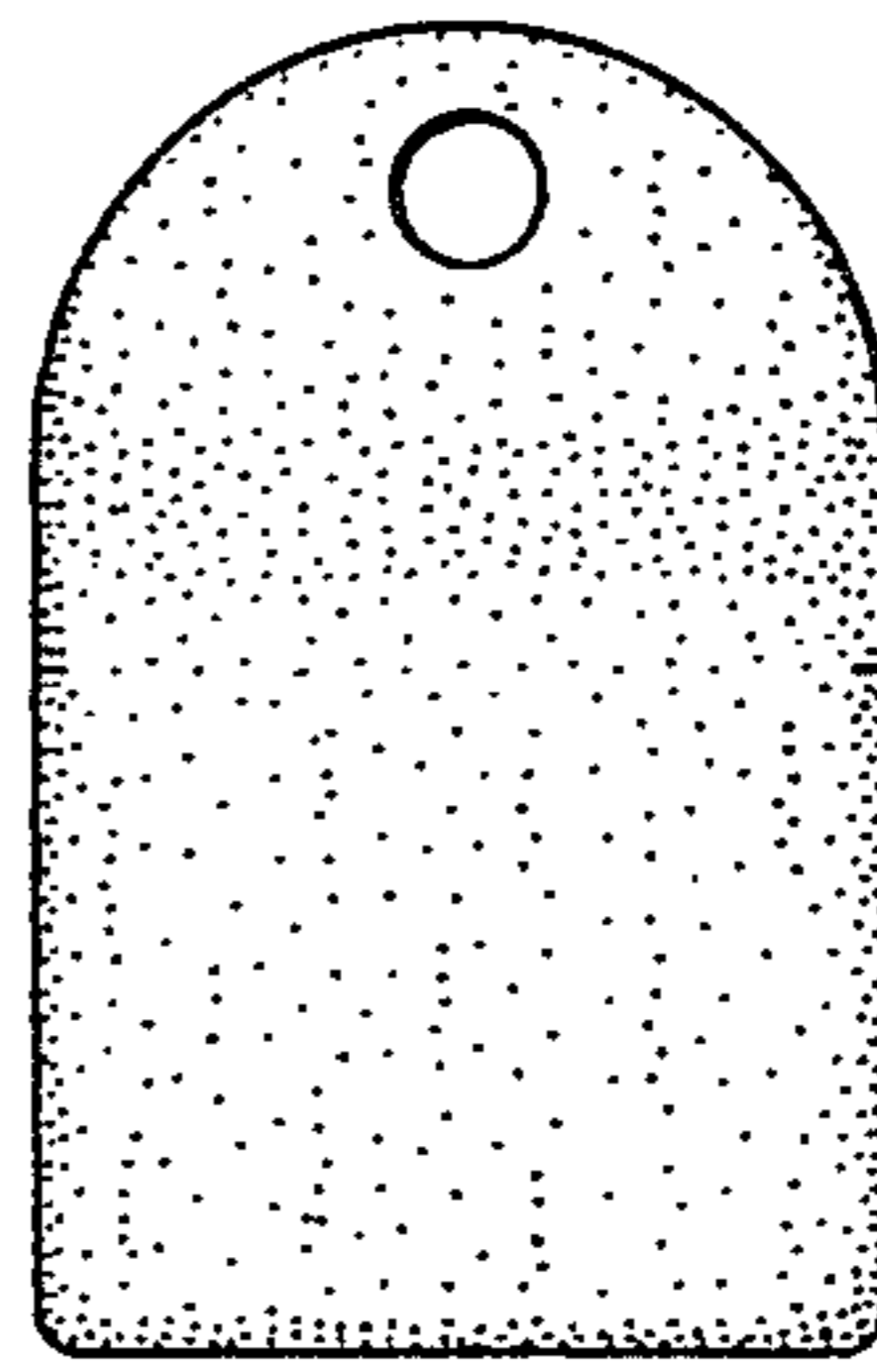

Fig. 6

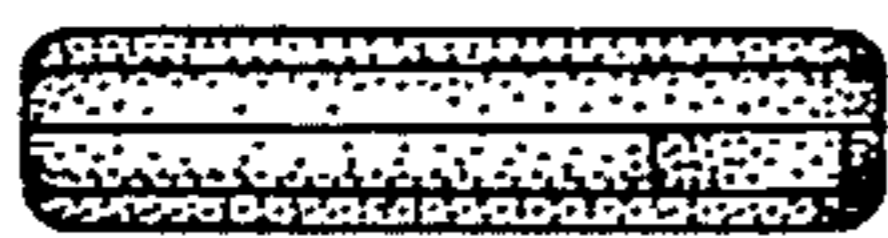

Fig. 8



Fig. 9



Fig. 7

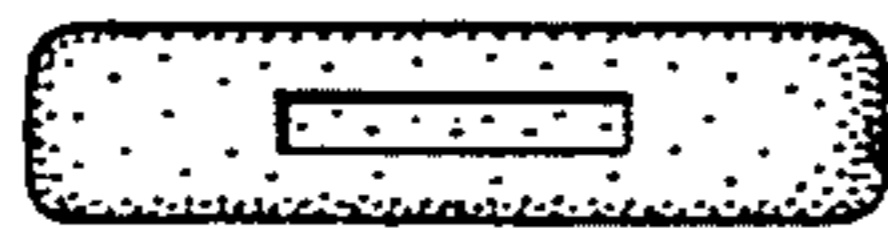

Fig. 10

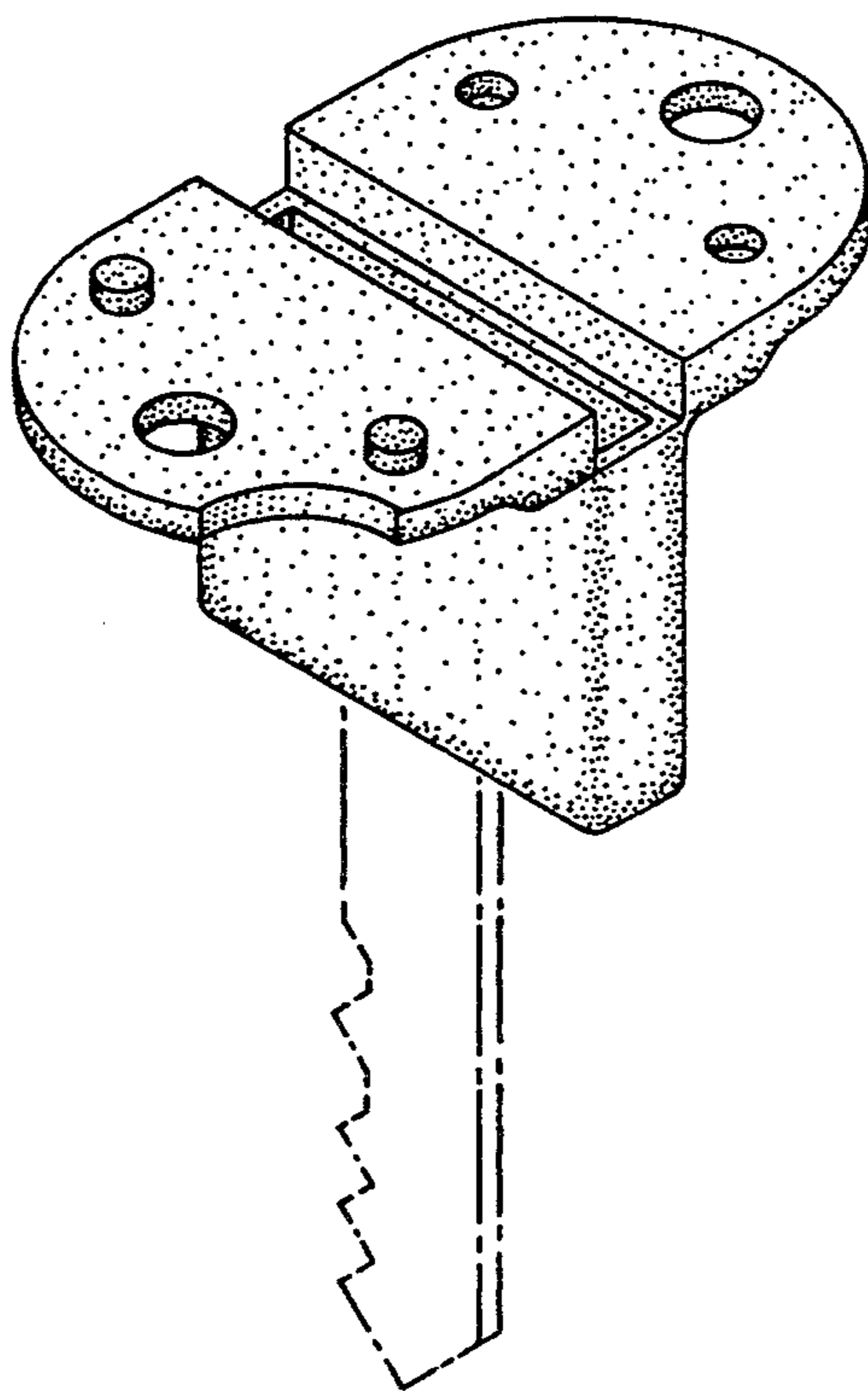

Fig. 11

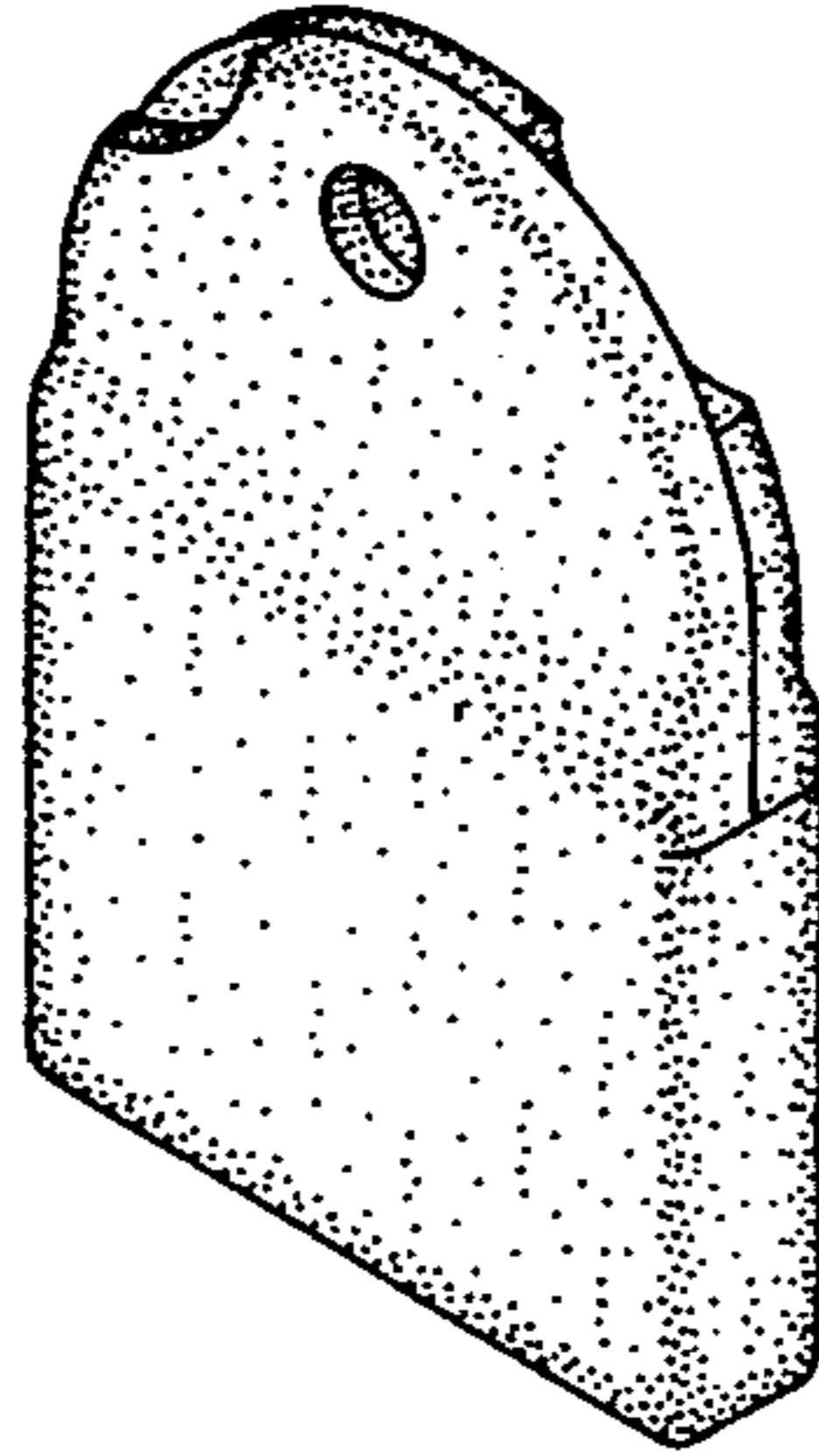

Fig. 12

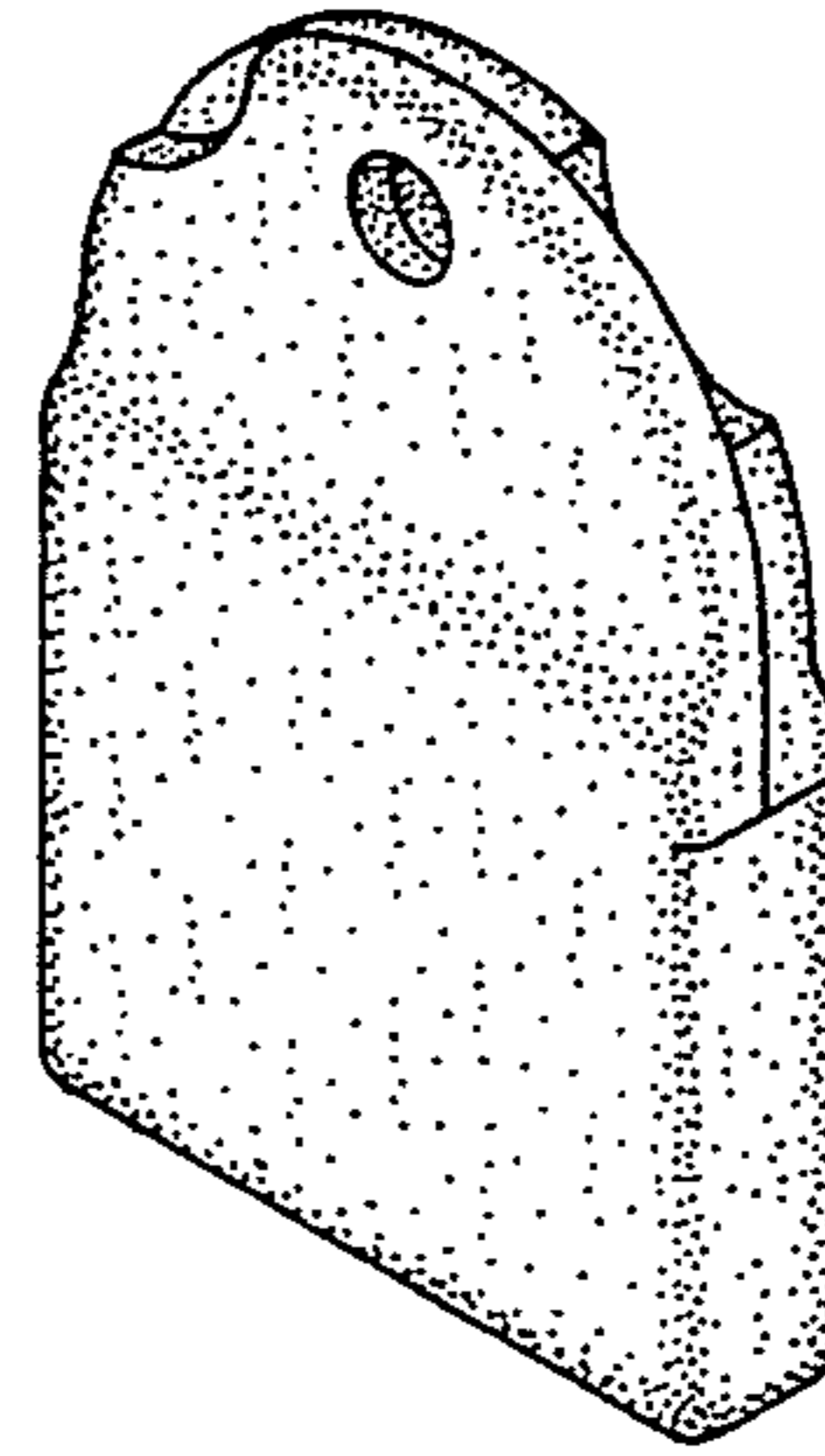

Fig. 13

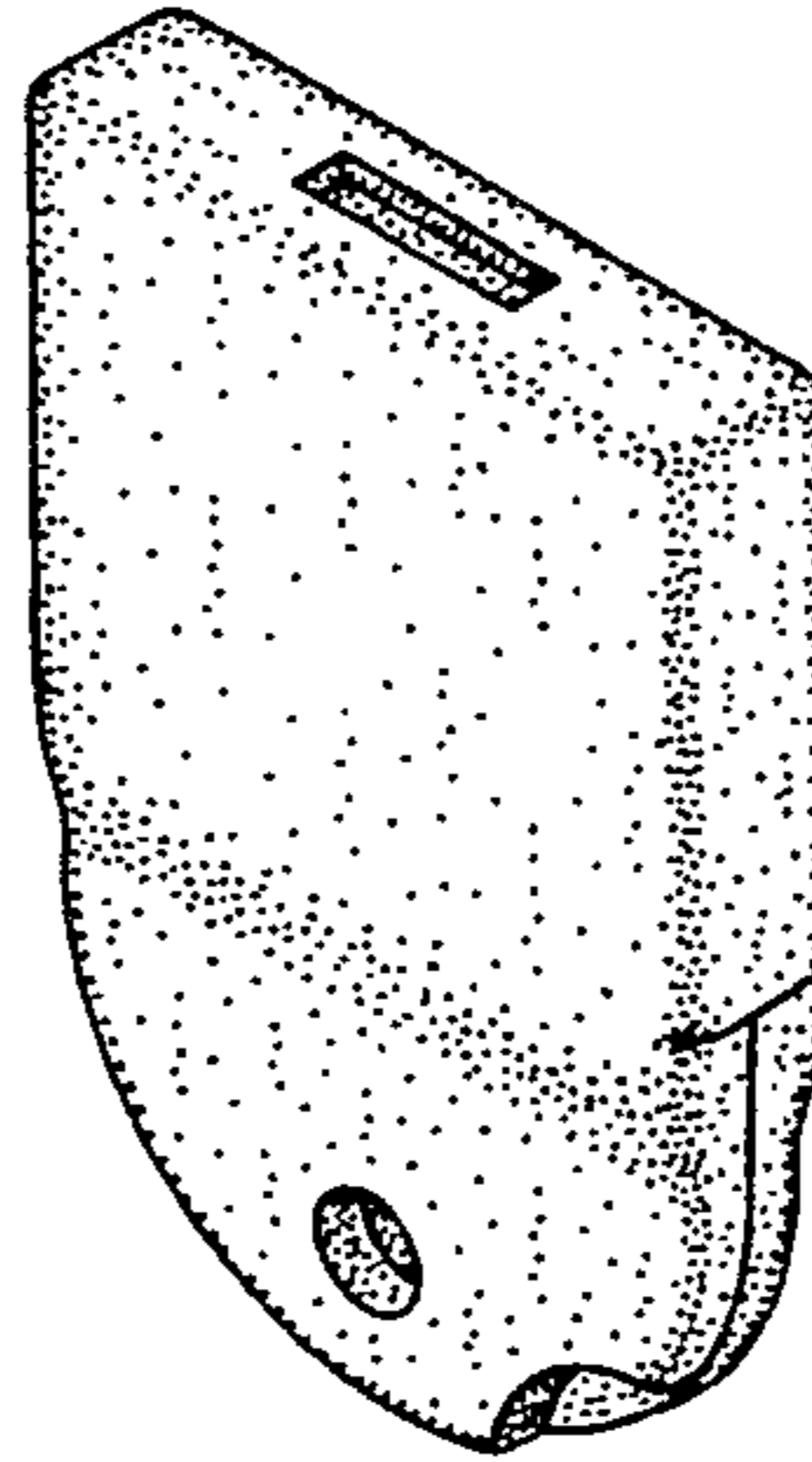

Fig. 14

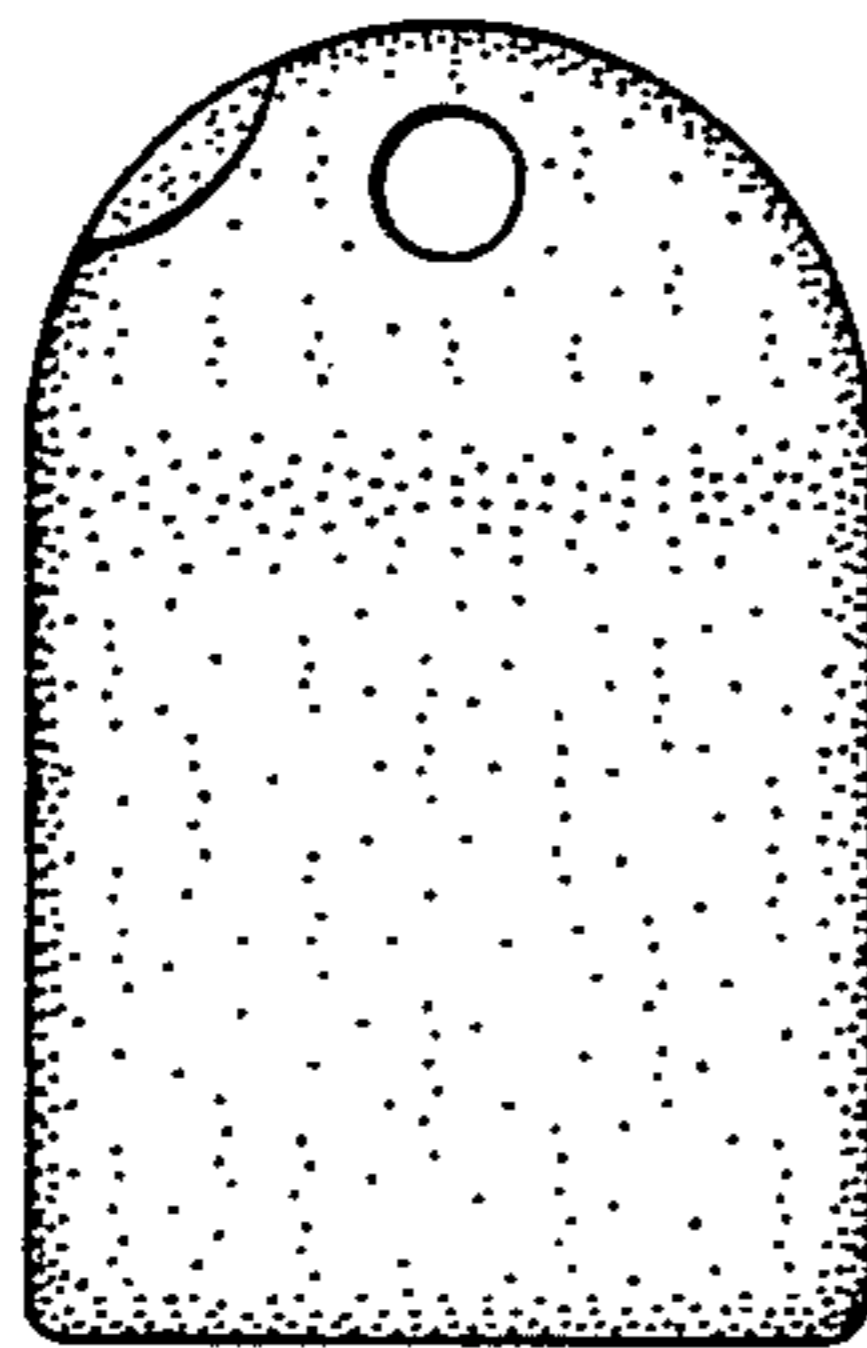

Fig. 15

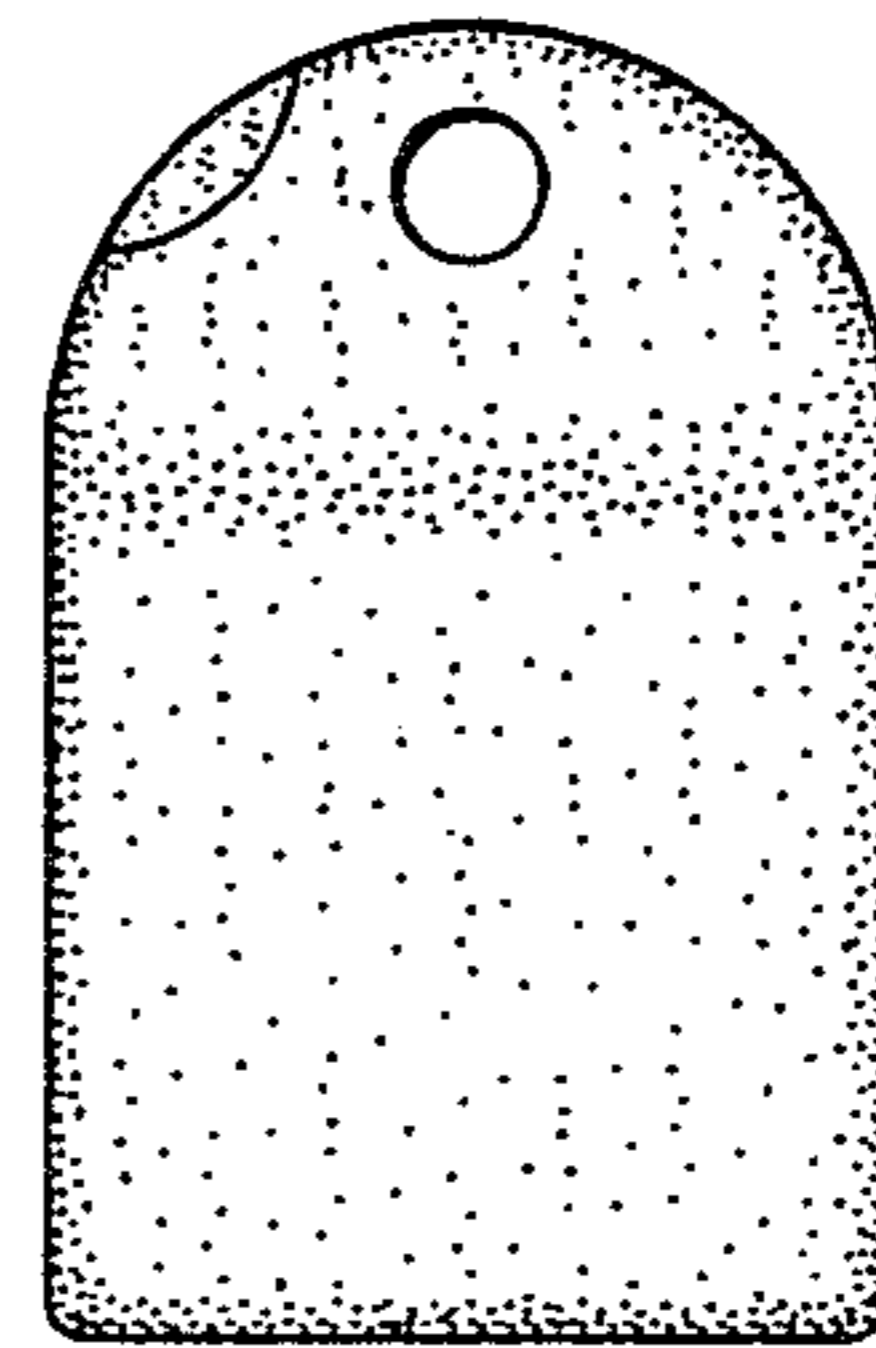

Fig. 16



Fig. 17



Fig. 18



Fig. 19

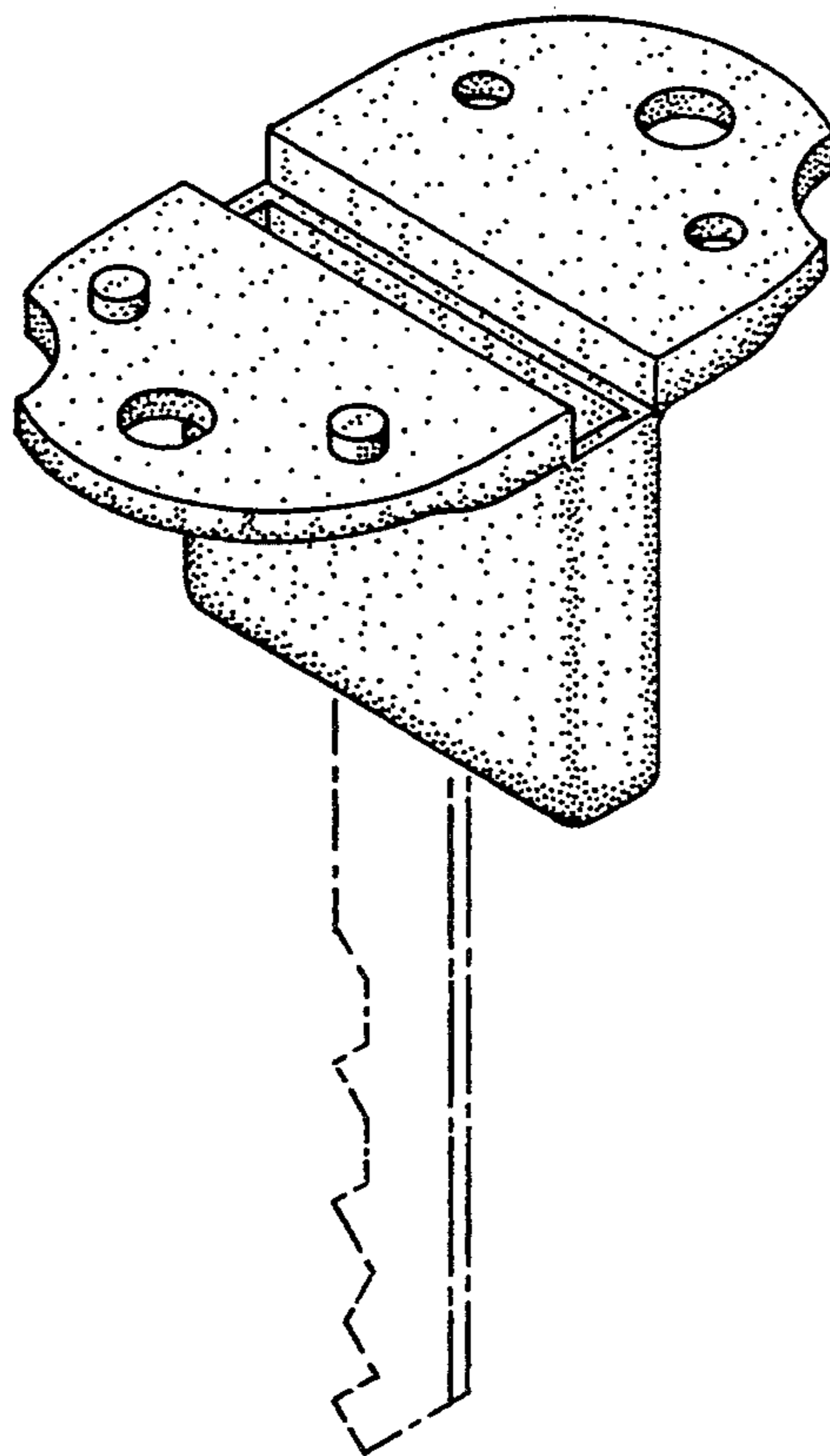

Fig. 20

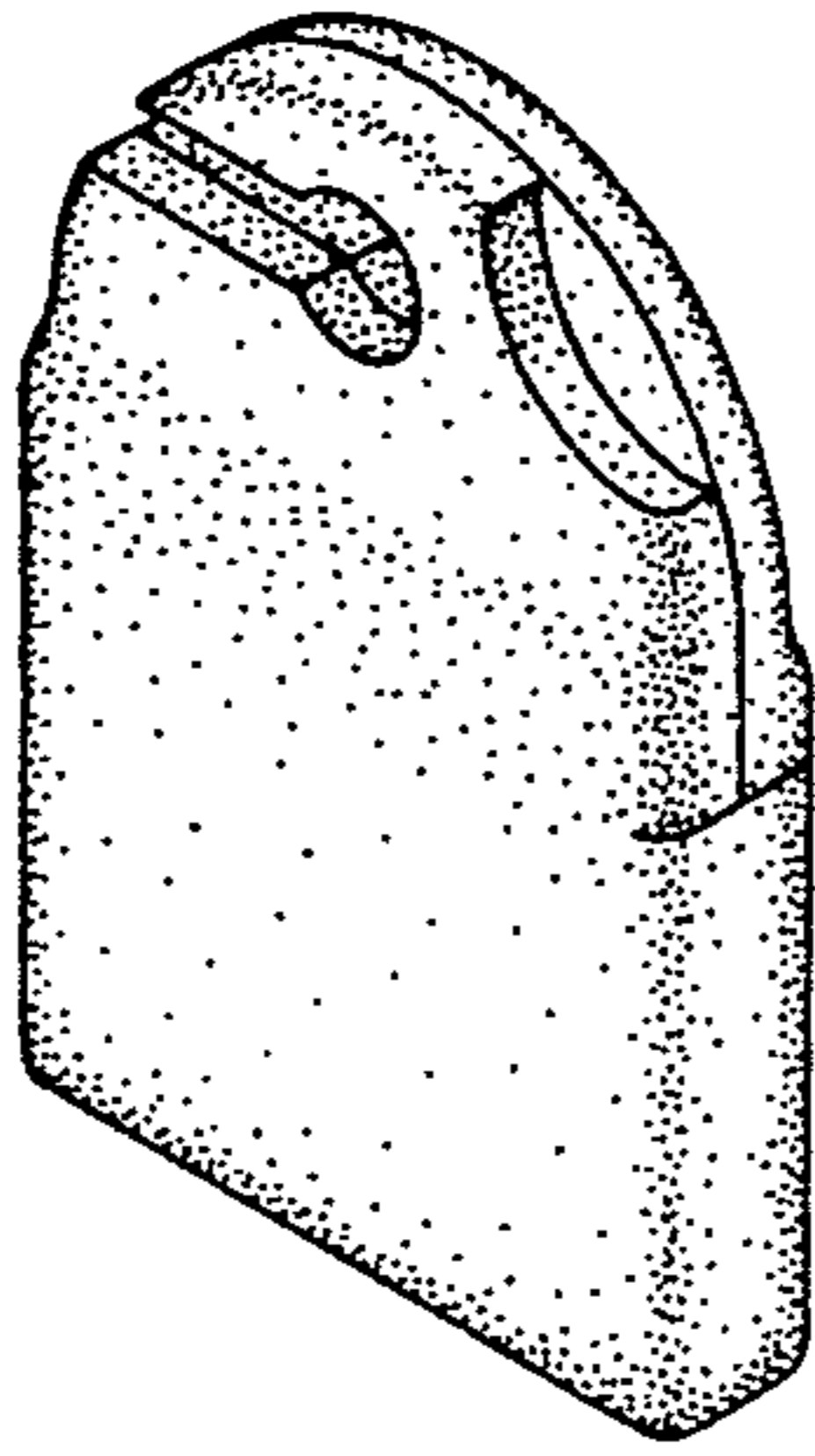

Fig. 21

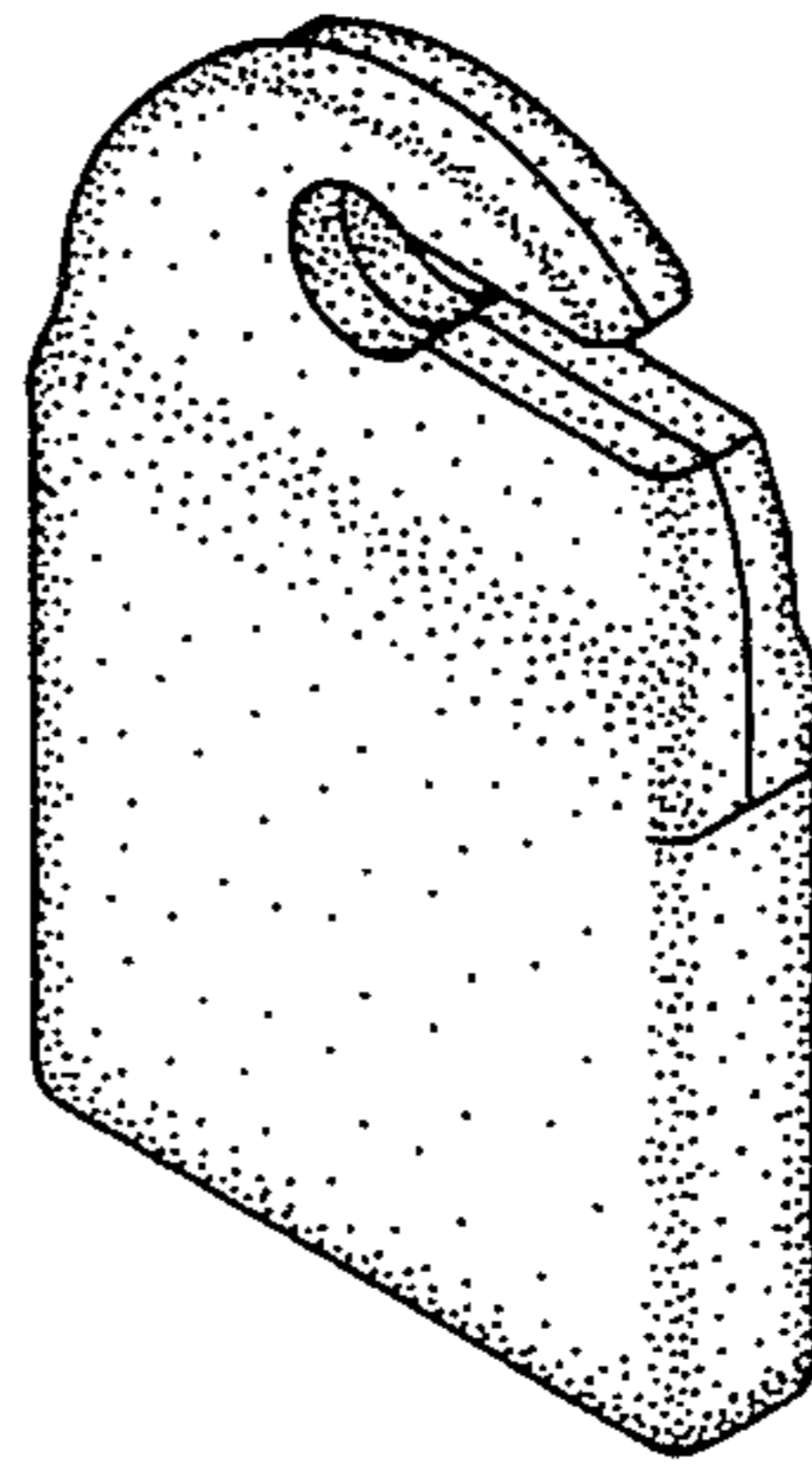

Fig. 22

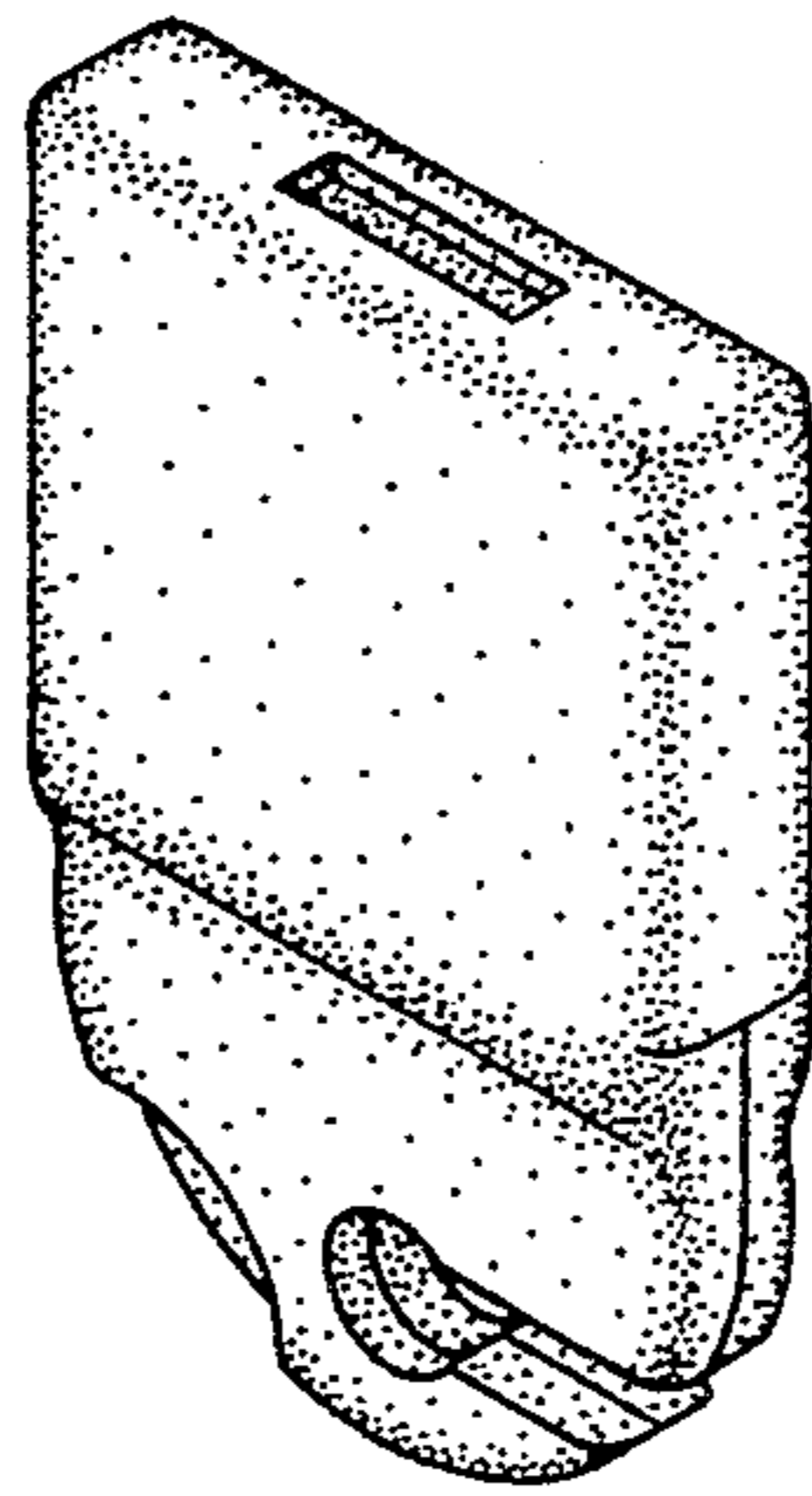

Fig. 23

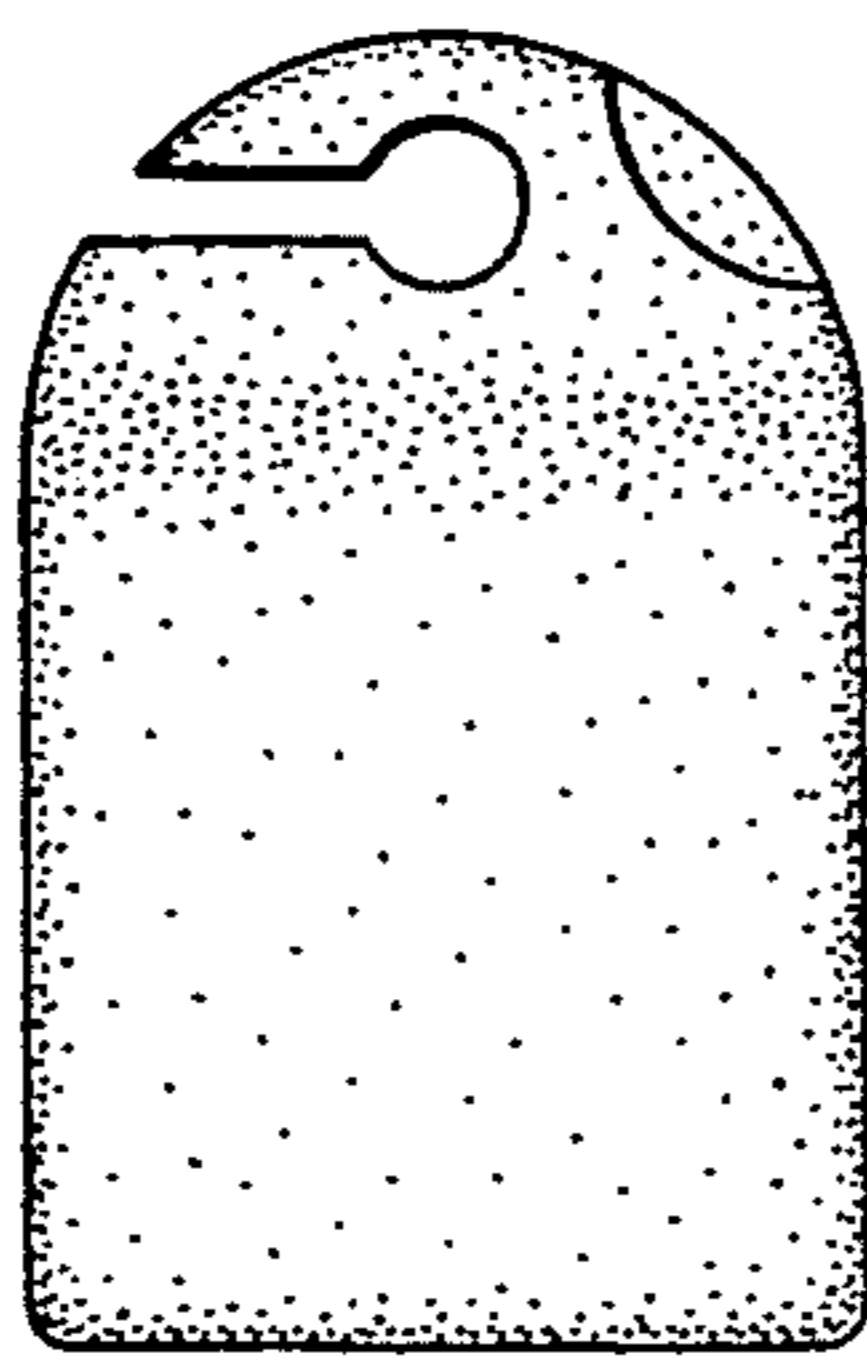

Fig. 24

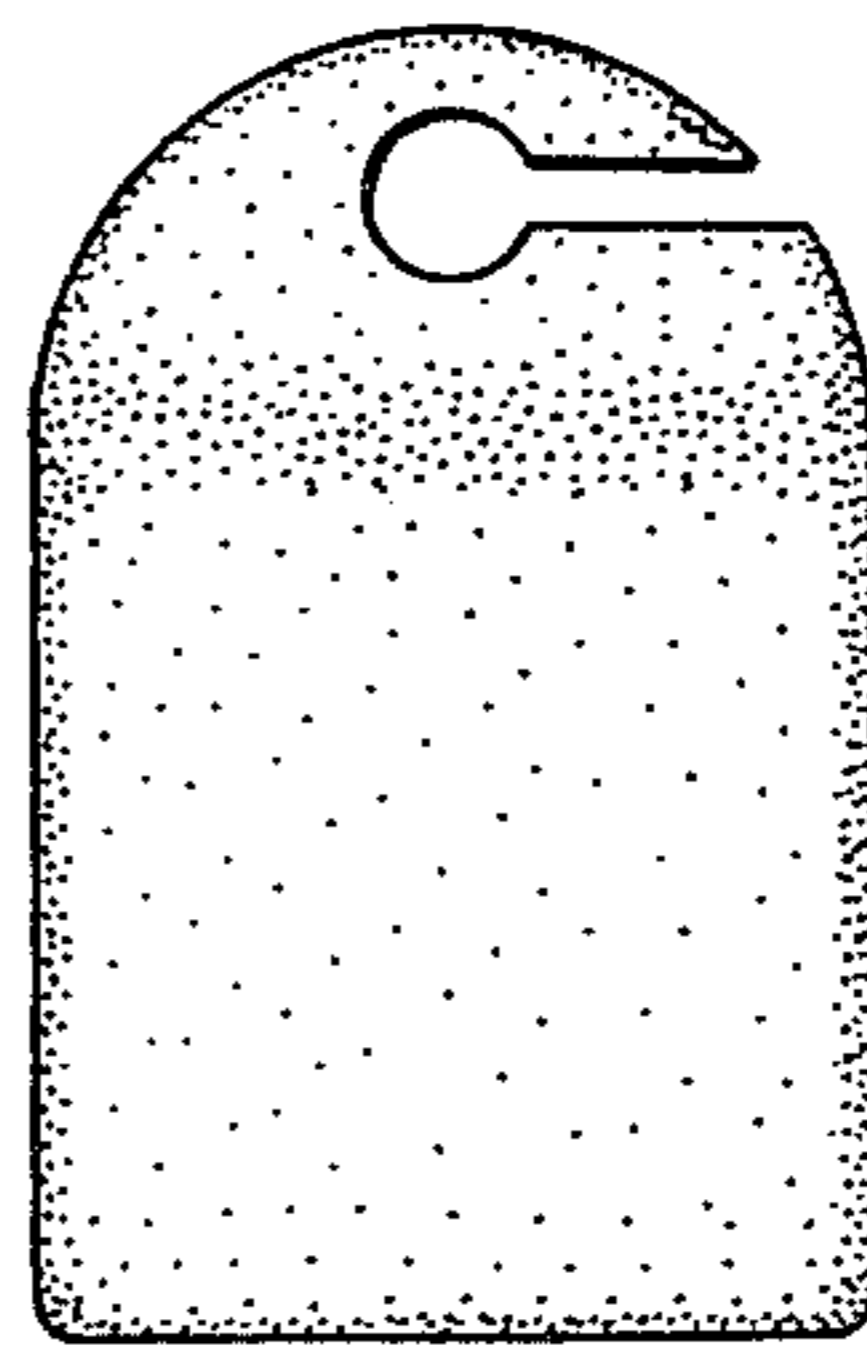

Fig. 25

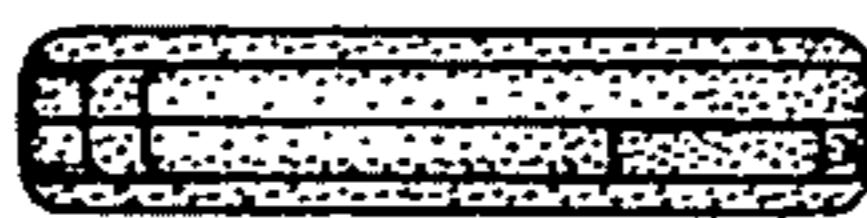

Fig. 26

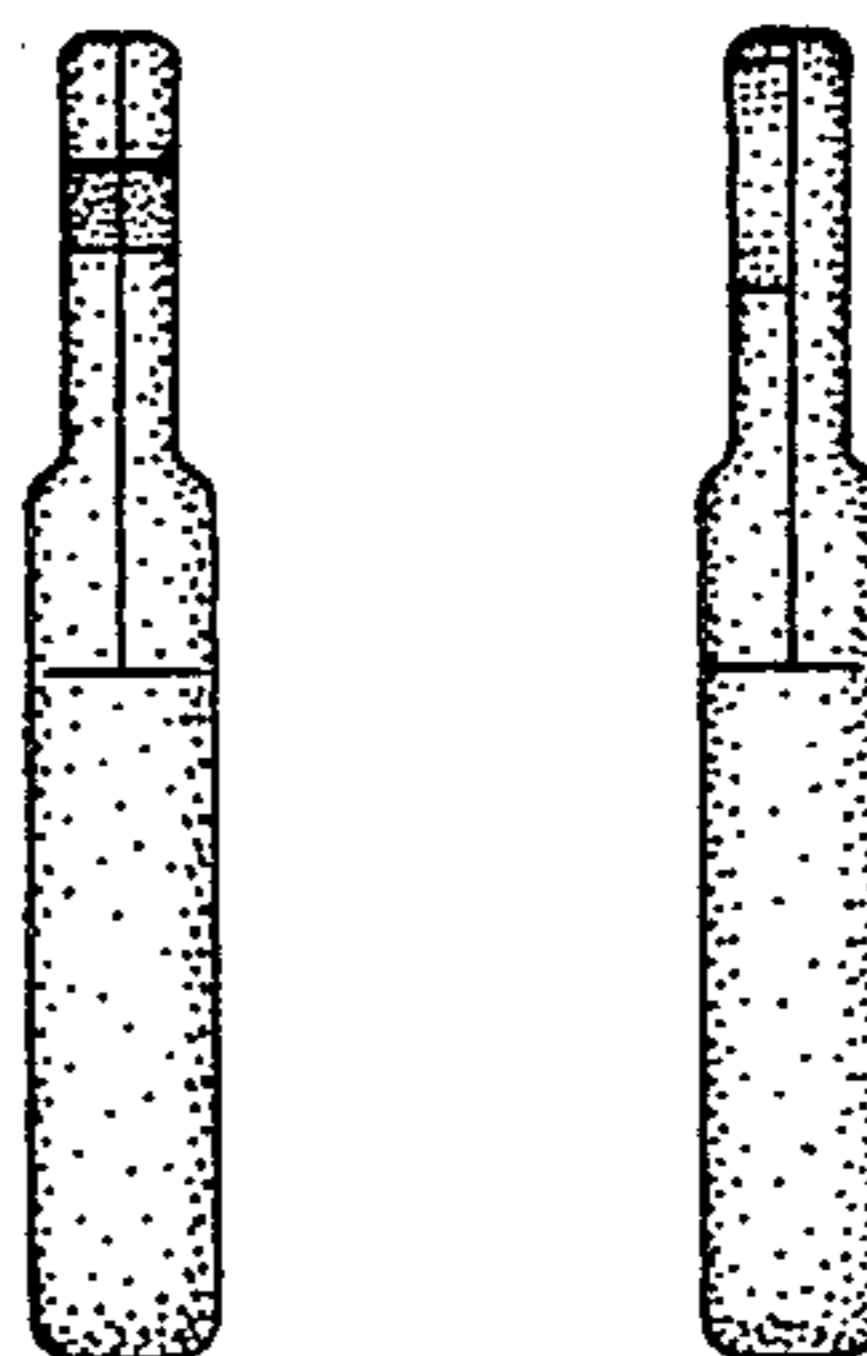

Fig. 27 Fig. 28

Fig. 29

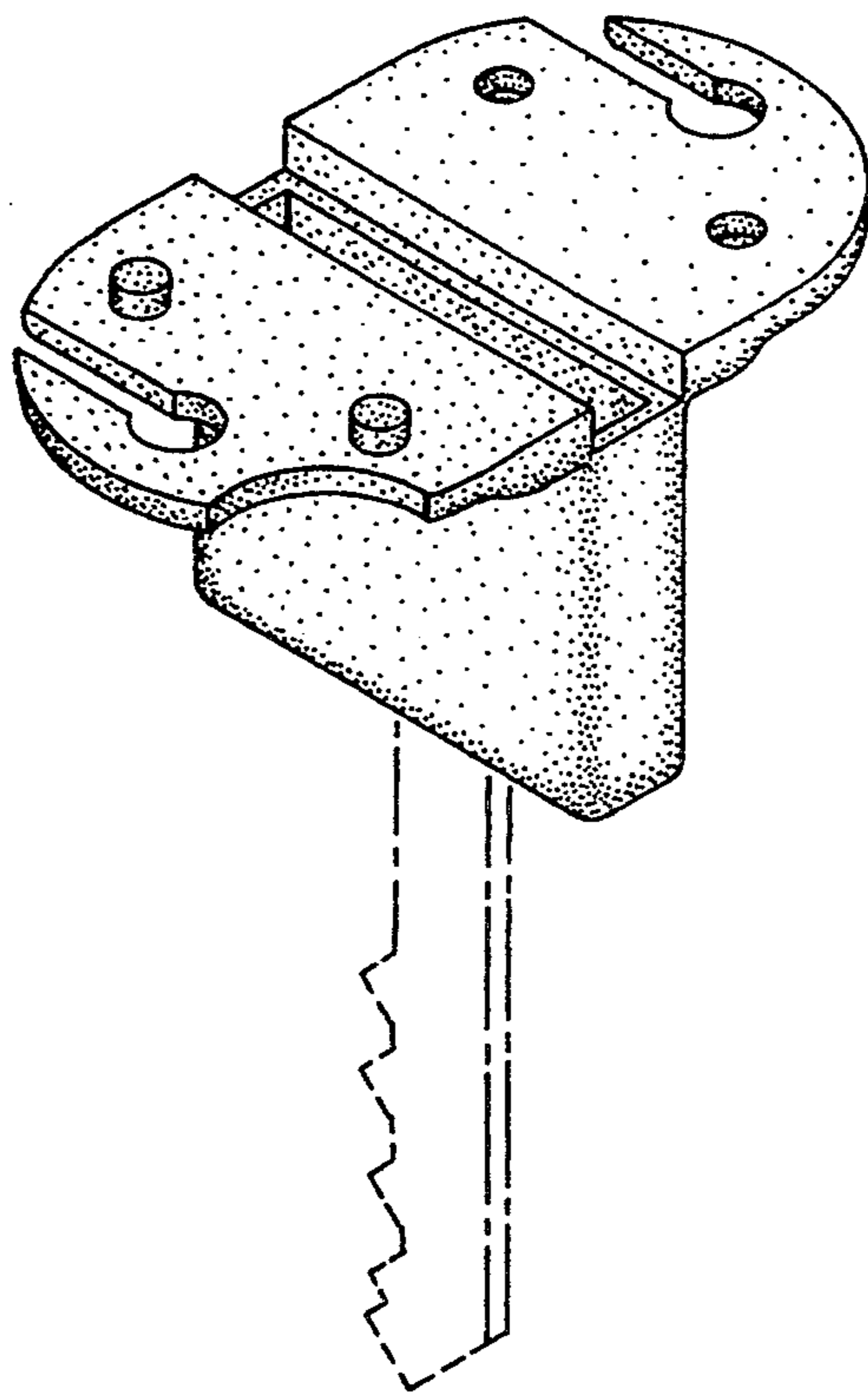

Fig. 30

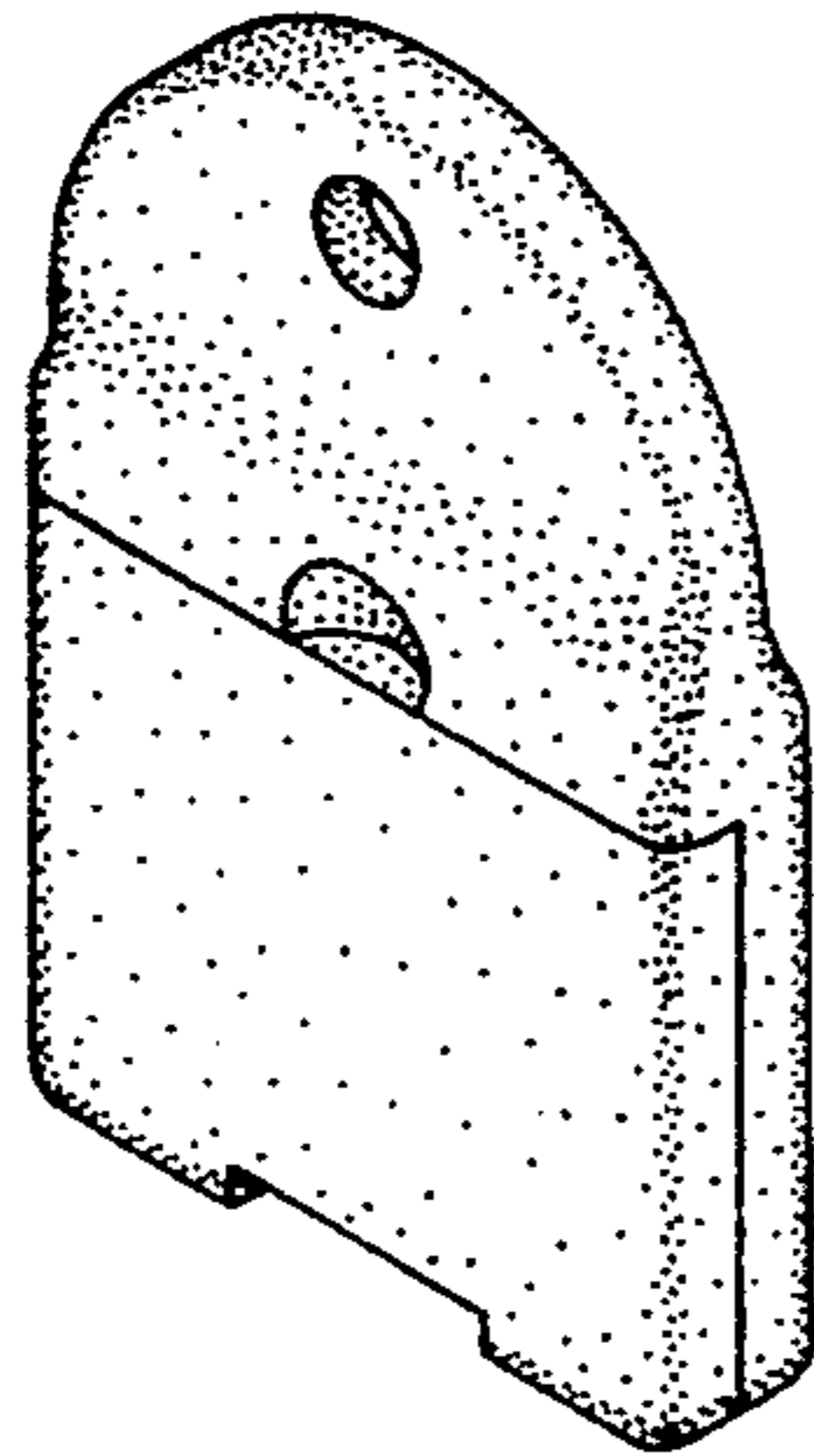

Fig. 31

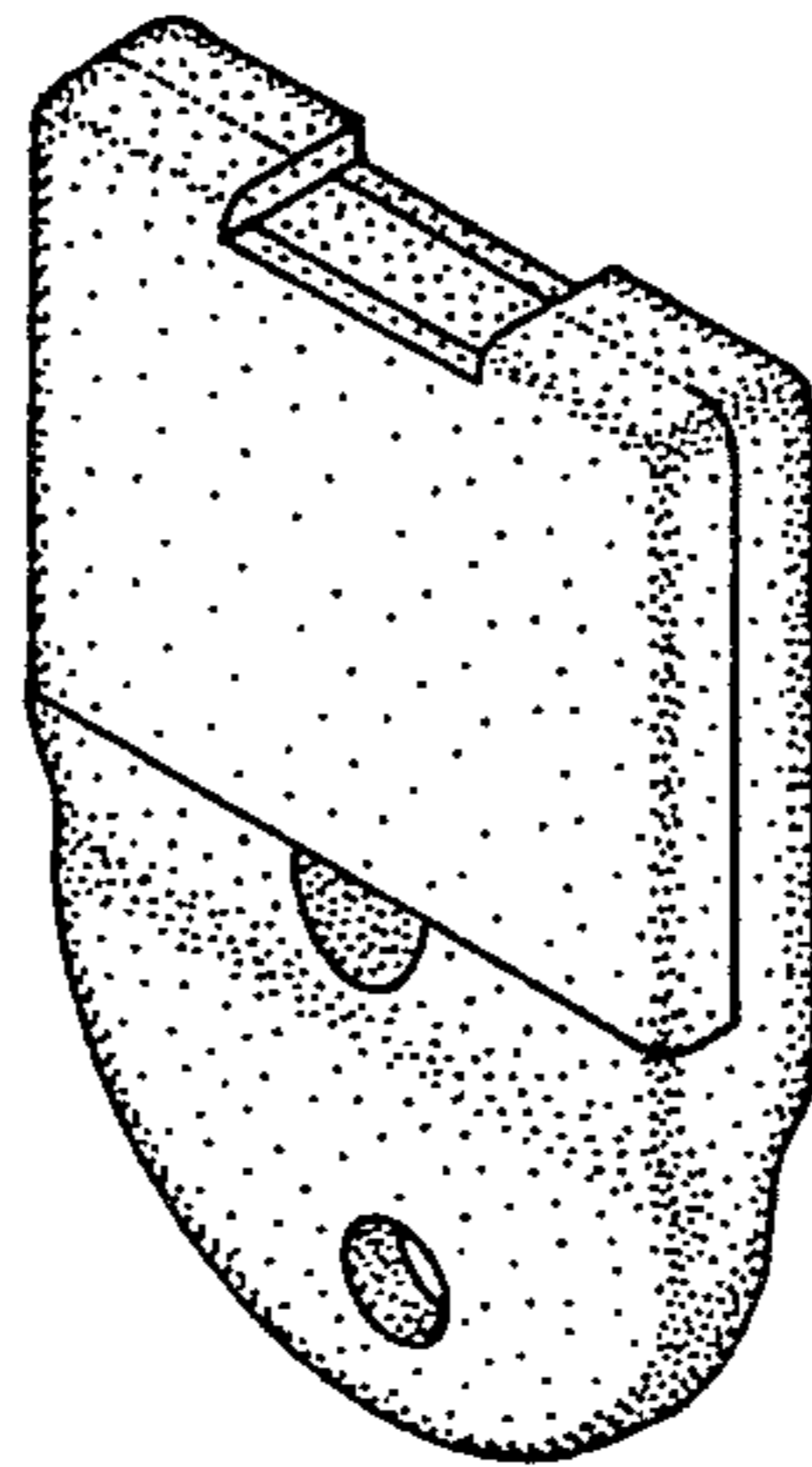
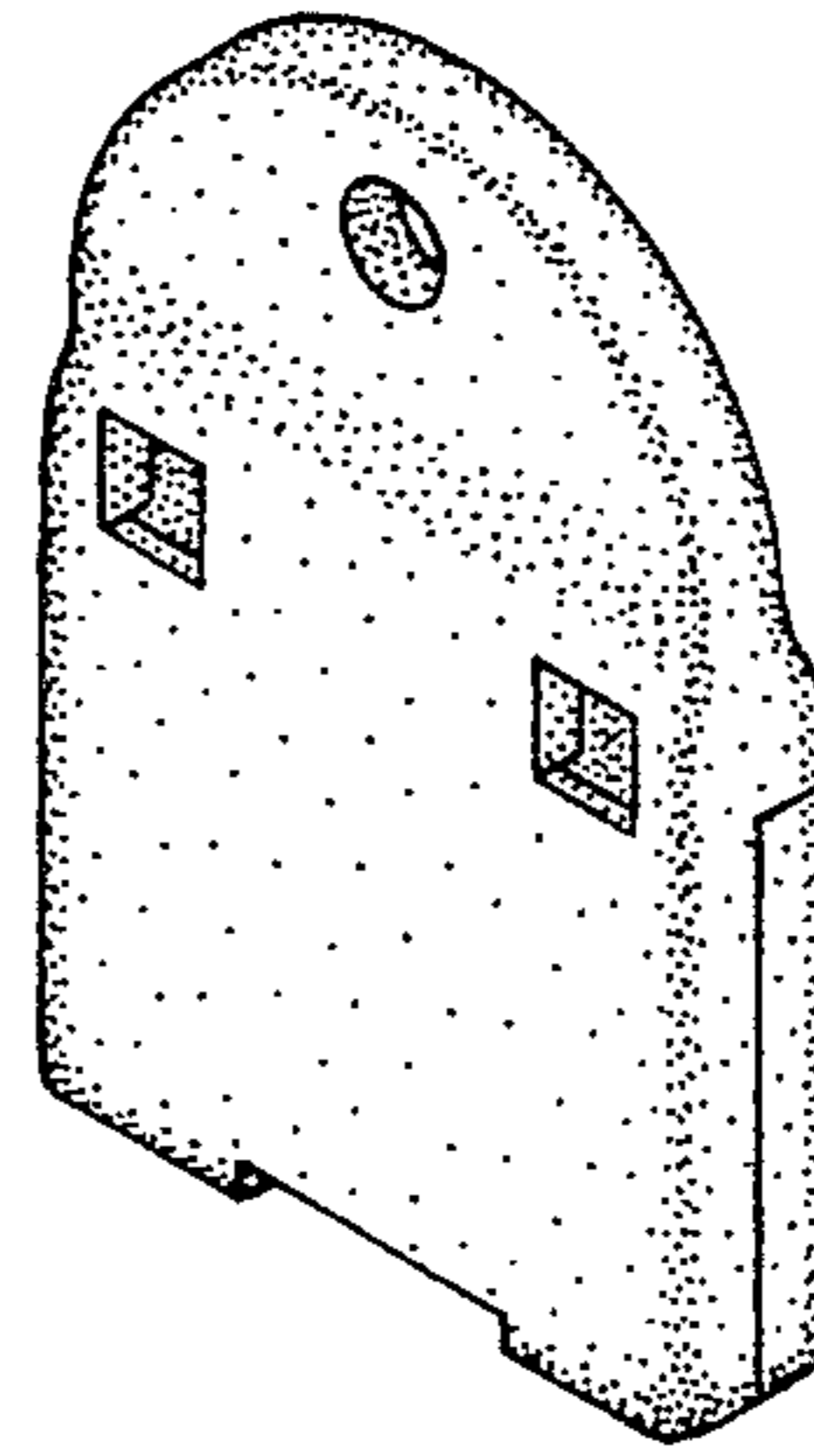

Fig. 32

Fig. 33

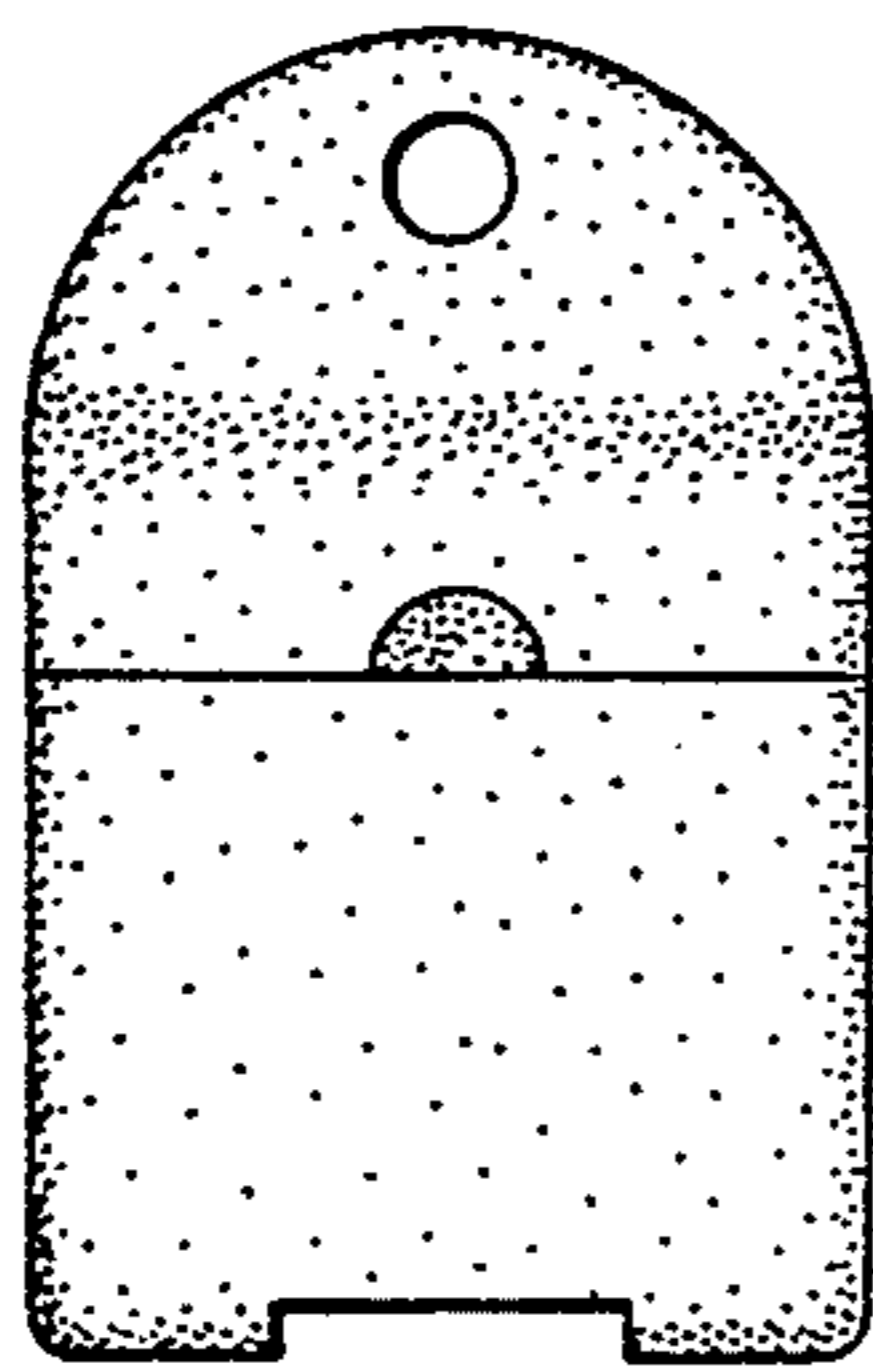

Fig. 34

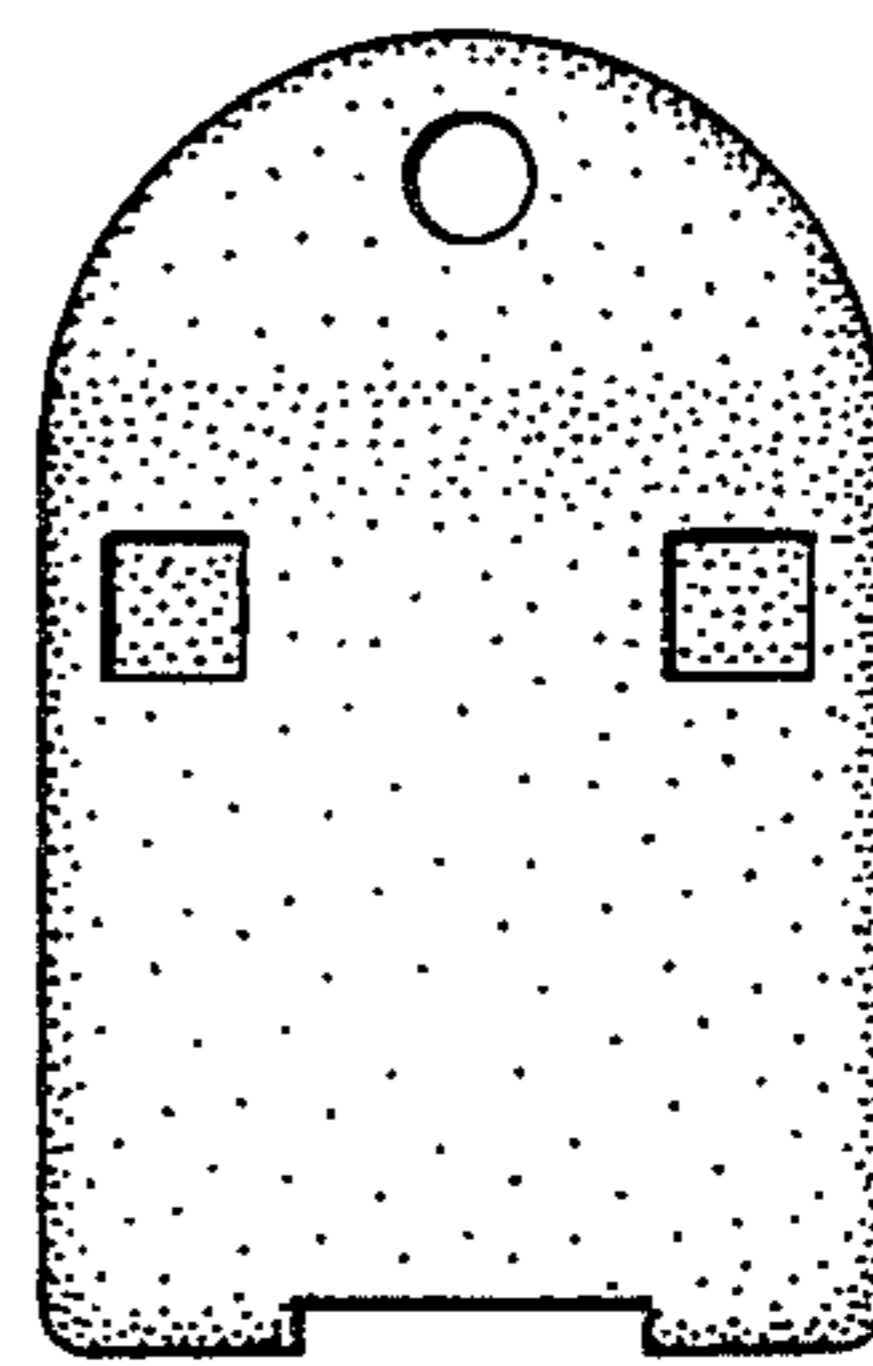

Fig. 35



Fig. 36



Fig. 37





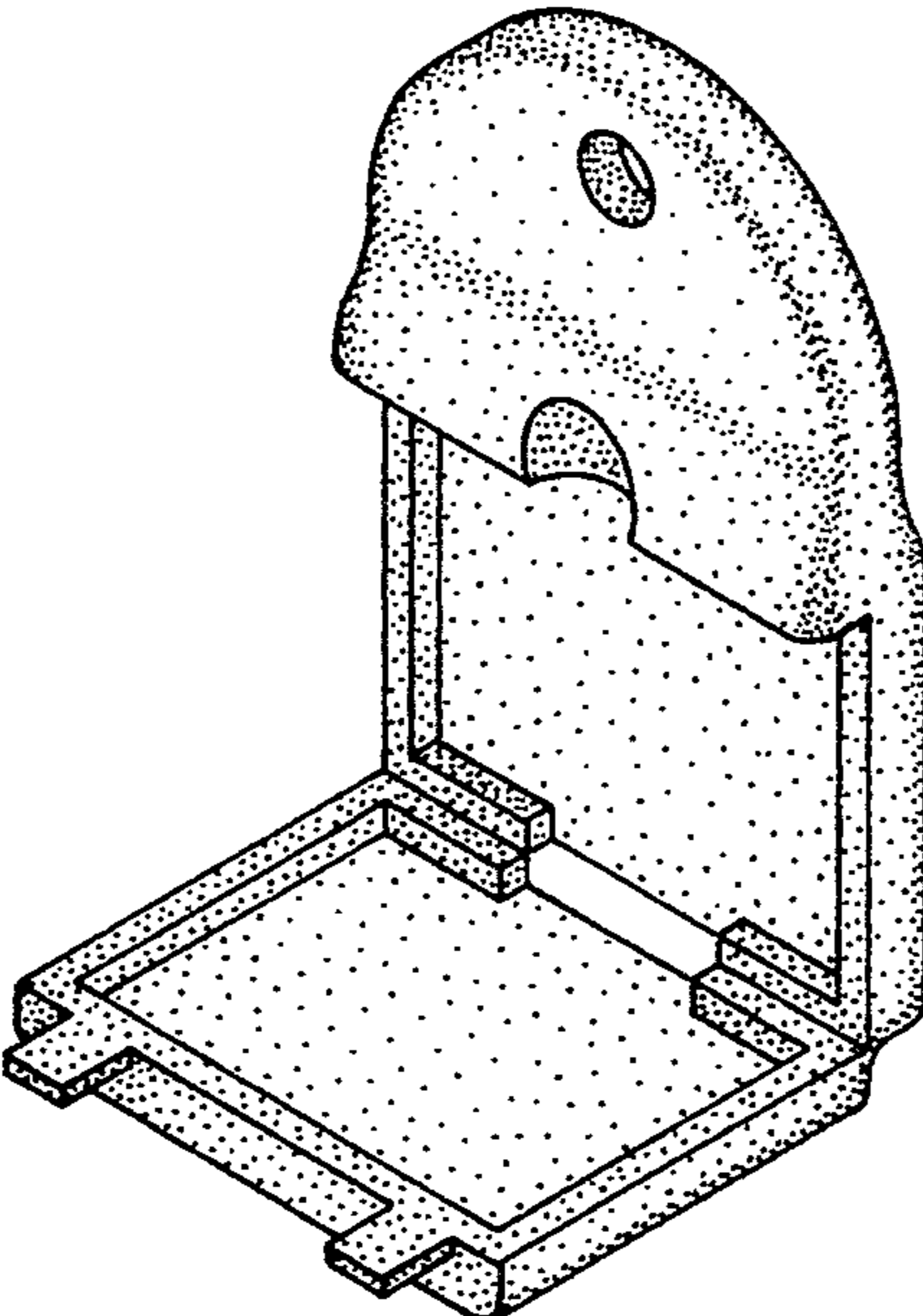

Fig. 38