



US00D352560S

United States Patent [19]
Lin

[11] **Patent Number: Des. 352,560**
[45] **Date of Patent: ** Nov. 15, 1994**

[54] **BRICK**

4,040,225 8/1977 Bretone D25/113

[76] **Inventor: Jung-fa Lin, 7 Lane Chung Cheng, Kwei Lin, Chushan, Nantou, Taiwan, Prov. of China**

Primary Examiner—A. Hugo Word
Assistant Examiner—Doris Clark
Attorney, Agent, or Firm—Morton J. Rosenberg; David I. Klein

[**] **Term: 14 Years**

[57] **CLAIM**

[21] **Appl. No.: 6,884**

The ornamental design for a brick, as shown and described.

[22] **Filed: Apr. 12, 1993**

[52] **U.S. Cl. D25/118**

[58] **Field of Search 52/596, 598, 607-612; 446/85, 118-119, 127; D25/112-118; D21/108**

DESCRIPTION

FIG. 1 is a perspective view of a brick in according with the design;
FIG. 2 is a front elevational view thereof;
FIG. 3 is a rear elevational view thereof;
FIG. 4 is a left side elevational view thereof;
FIG. 5 is a right side elevational view thereof;
FIG. 6 is a top plan view thereof; and,
FIG. 7 is a bottom plan view thereof.

[56] **References Cited**

U.S. PATENT DOCUMENTS

439,641 11/1890 Farrar D25/114
1,543,635 6/1925 Wickson 52/609
2,201,110 5/1940 Makram D25/113

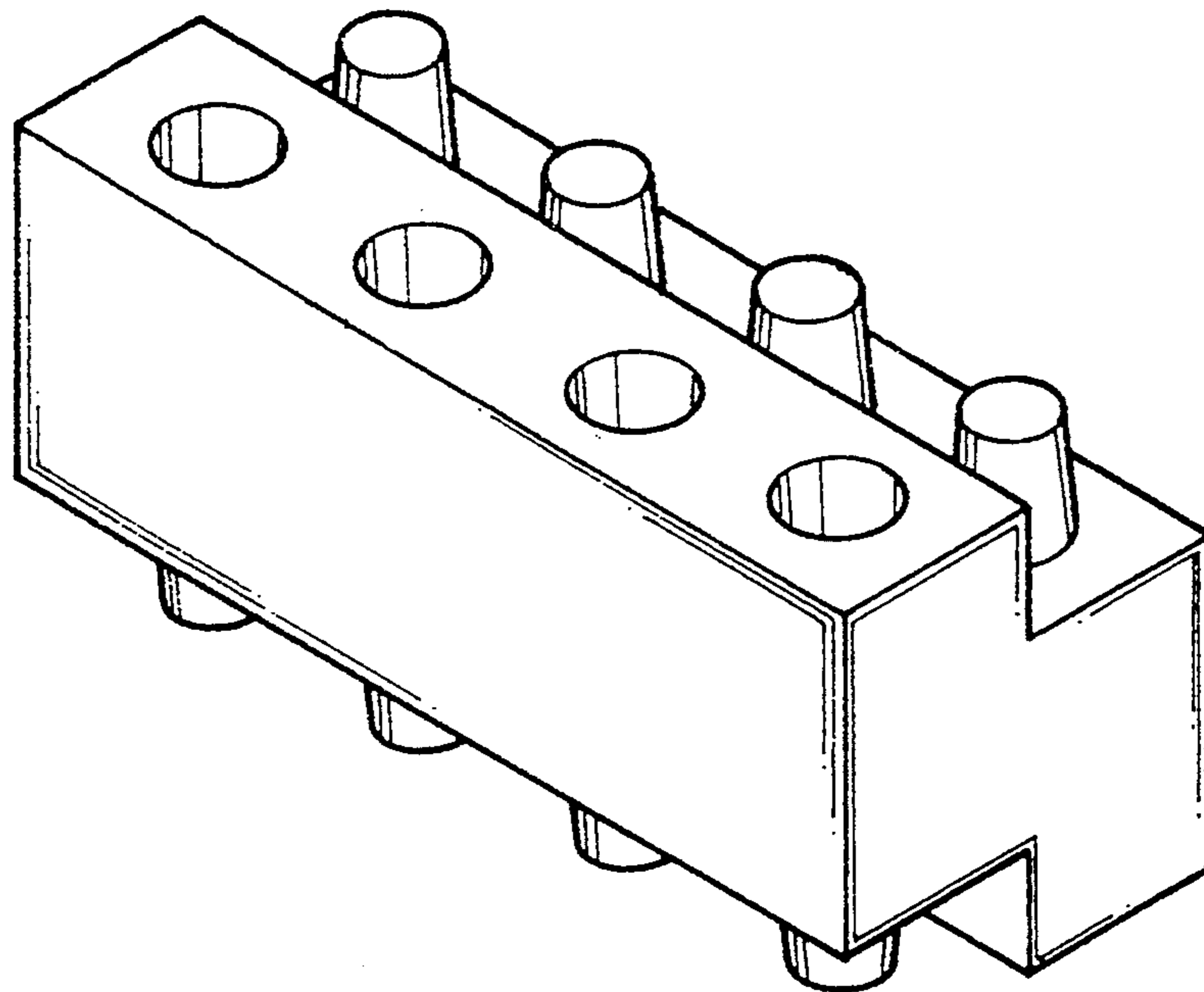

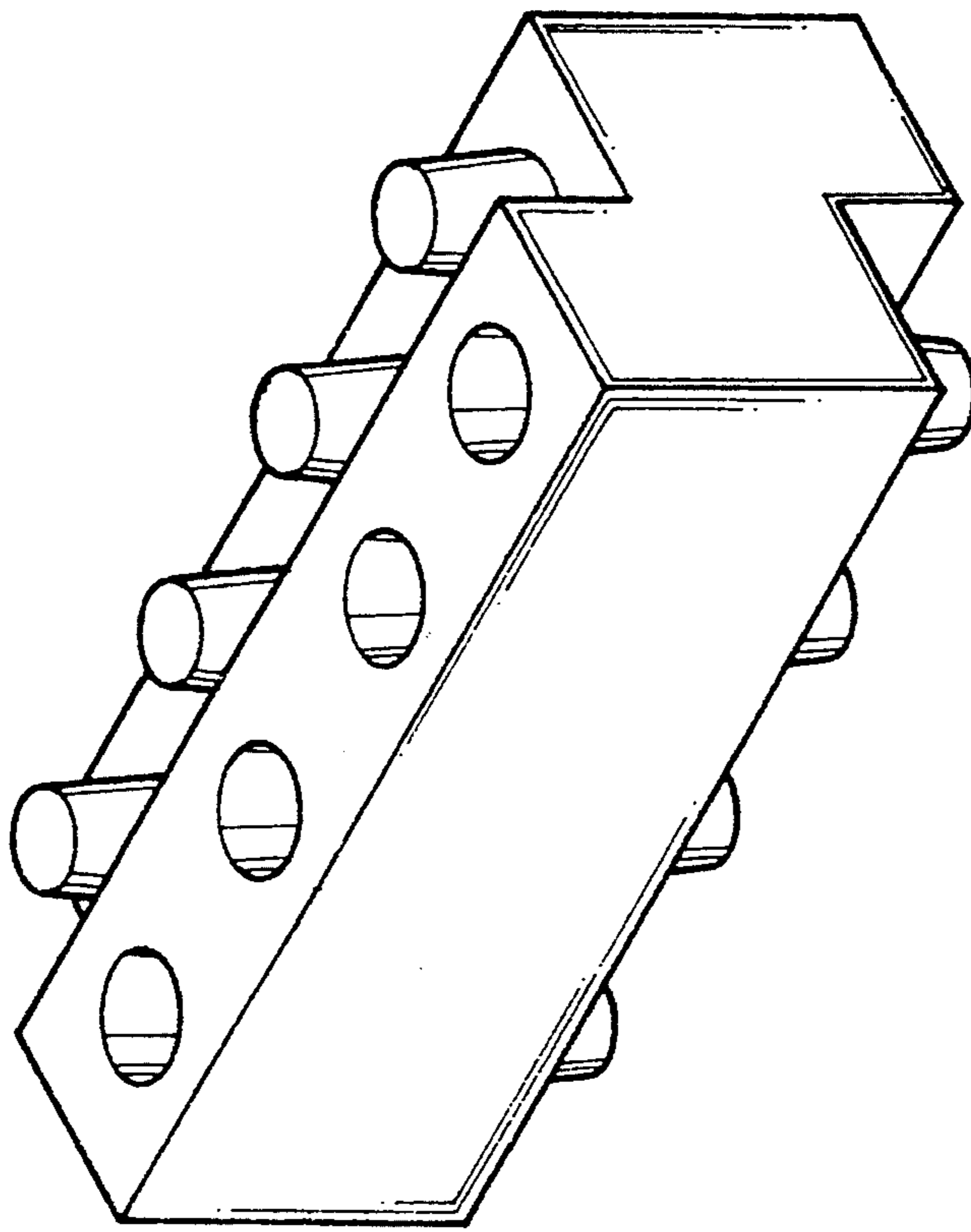

FIG. 1

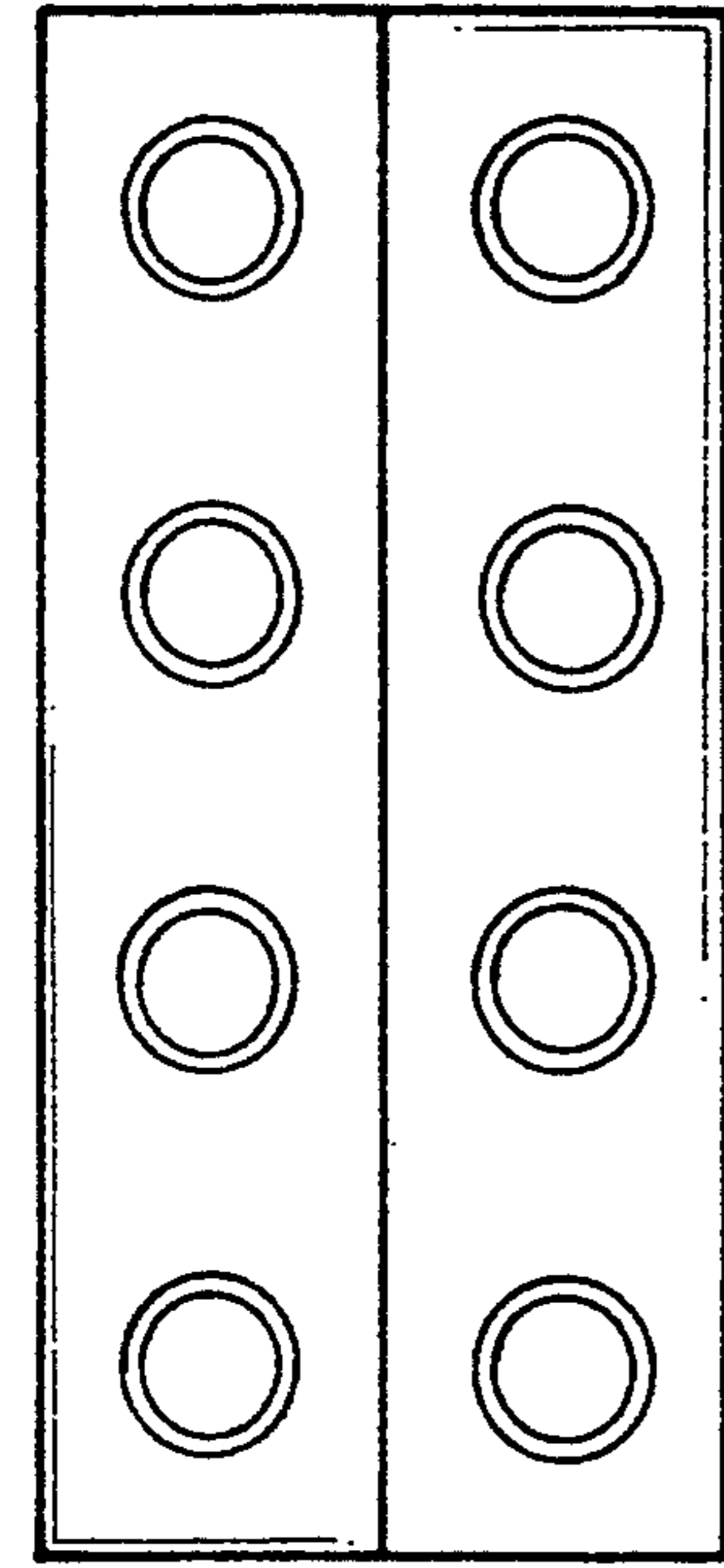

FIG. 6

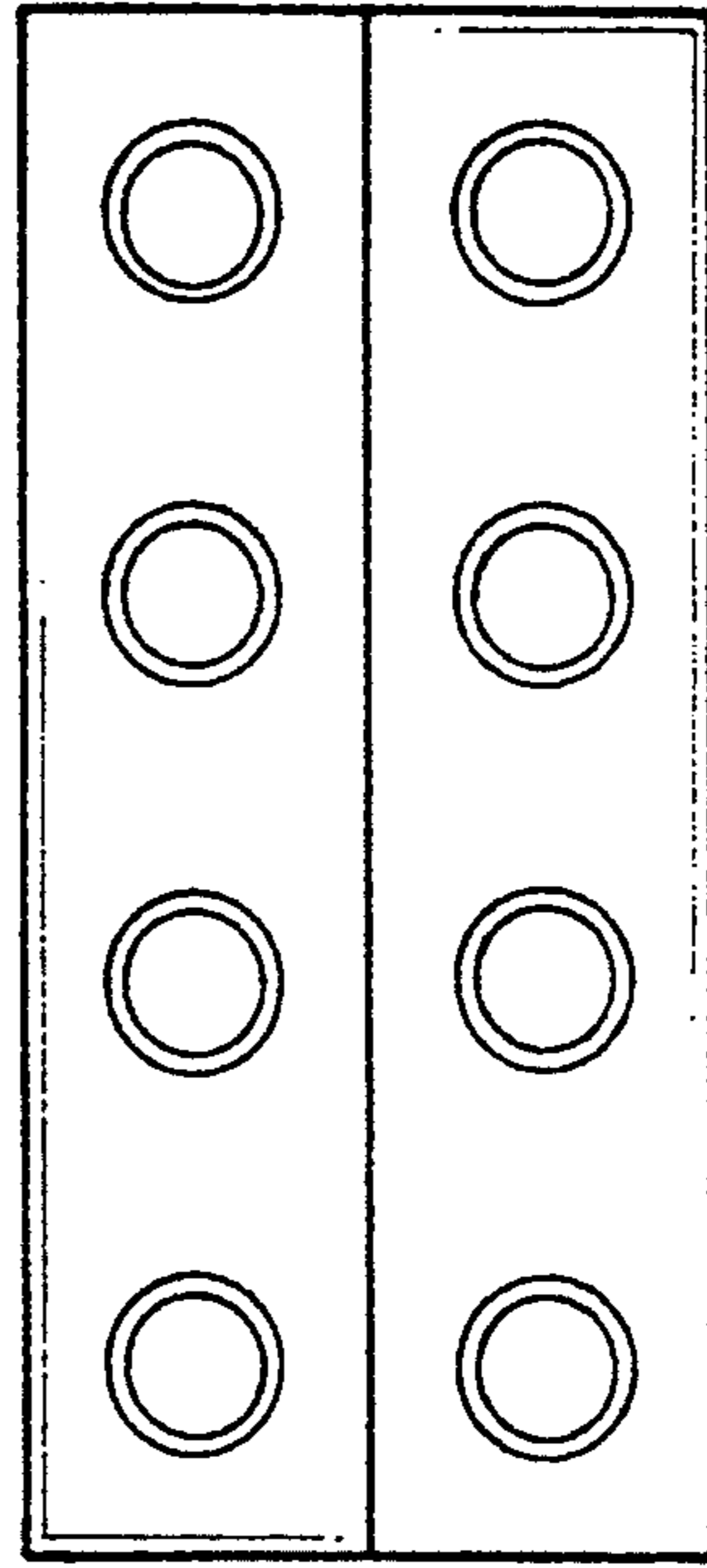

FIG. 7

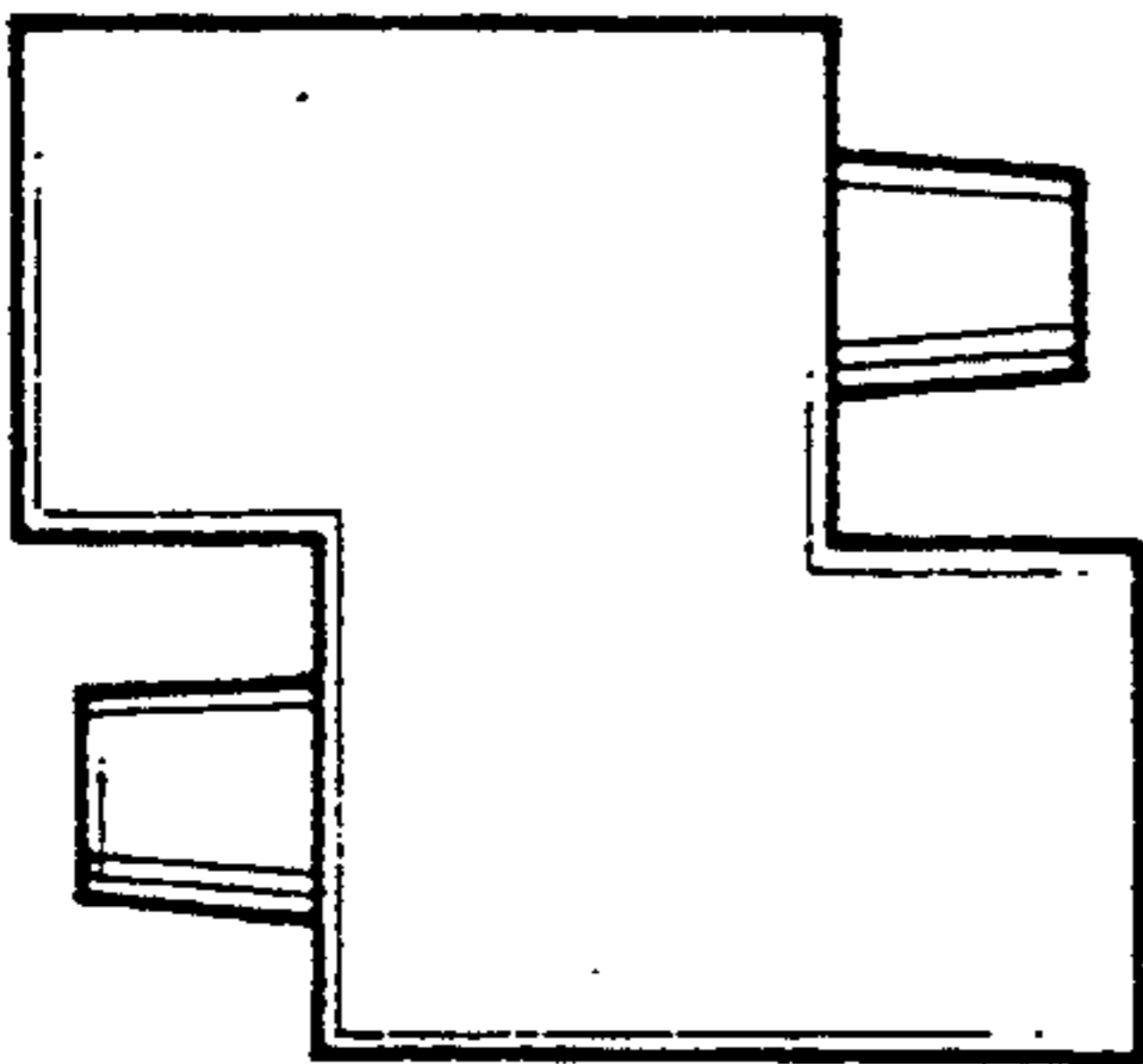

FIG. 4

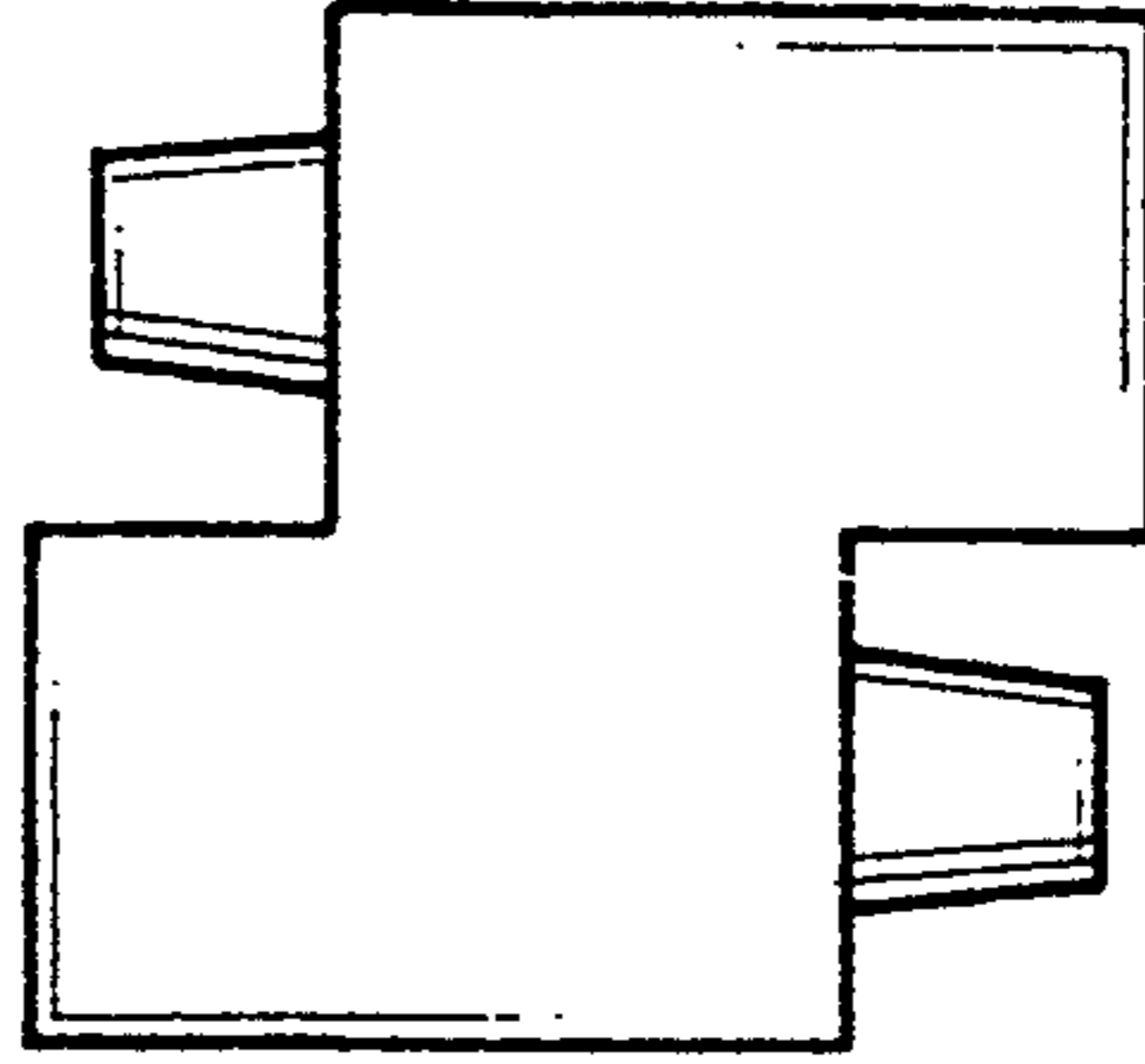

FIG. 5

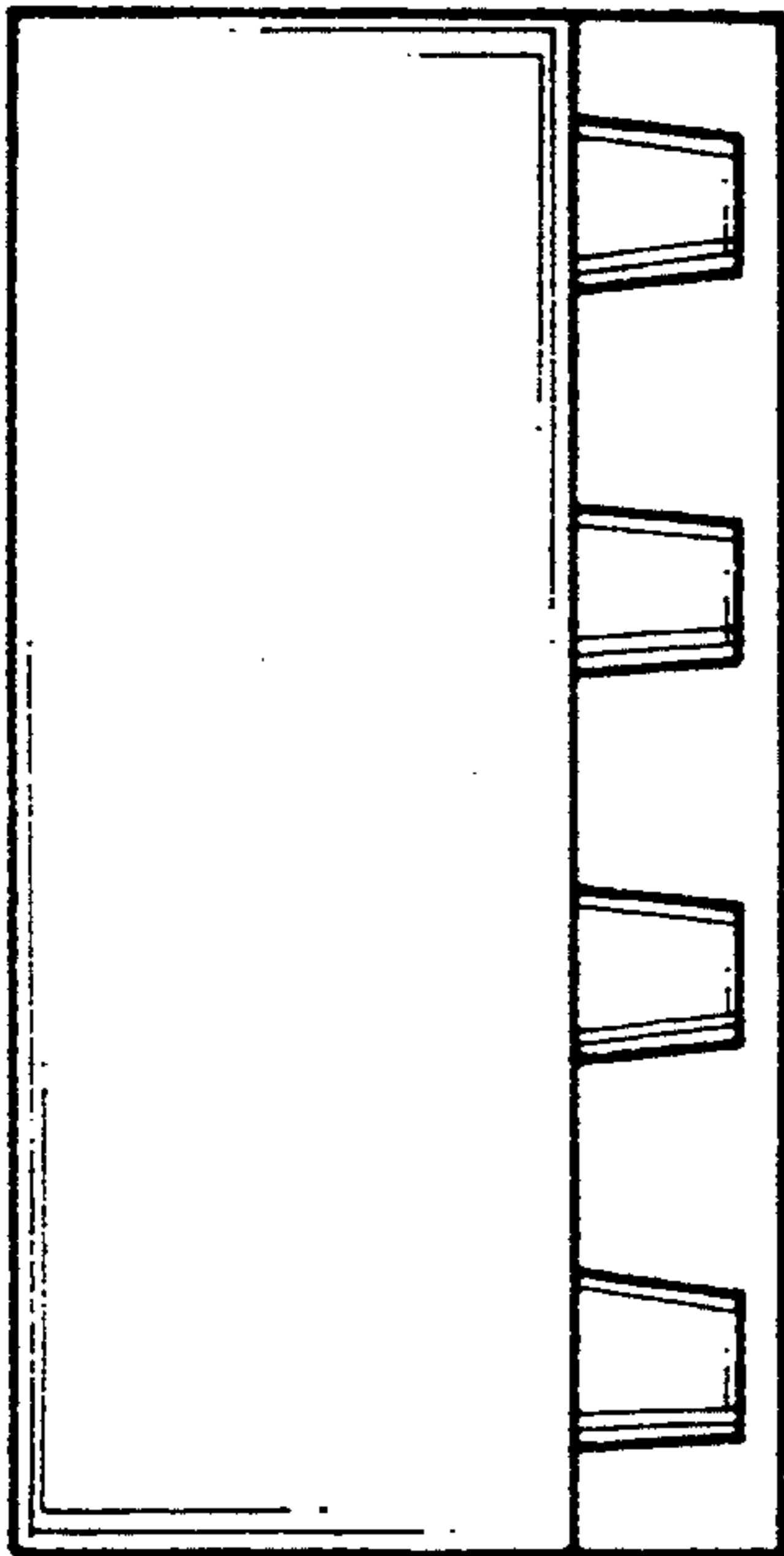

FIG. 2

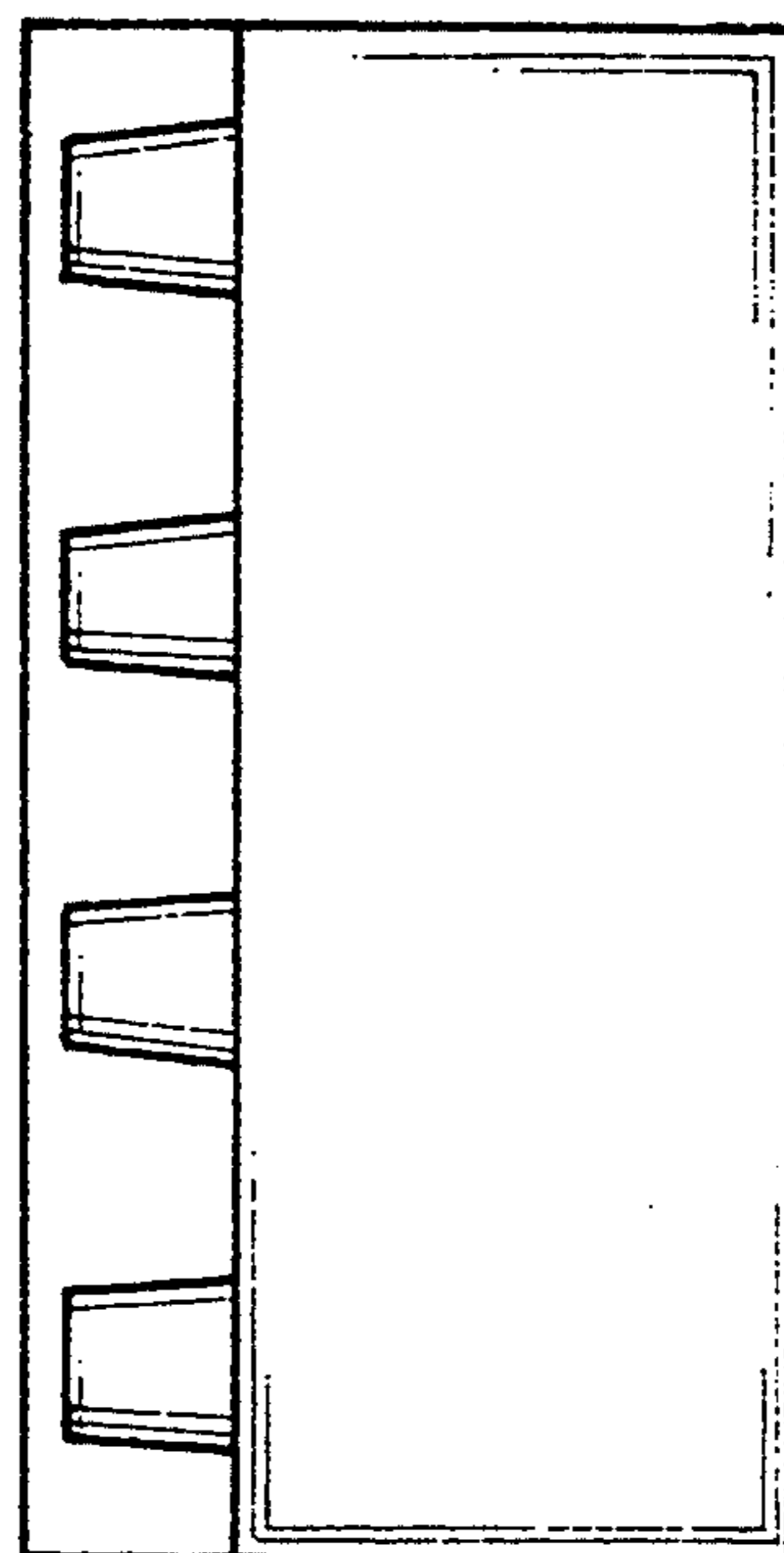

FIG. 3