



US00D352547S

United States Patent [19] McKeone

[11] Patent Number: **Des. 352,547**
[45] Date of Patent: **** Nov. 15, 1994**

[54] **SPOUT**
[75] Inventor: **William C. McKeone, Sheboygan, Wis.**
[73] Assignee: **Kohler Co., Kohler, Wis.**
[*] Notice: **The portion of the term of this patent subsequent to Dec. 14, 2007 has been disclaimed.**
[**] Term: **14 Years**
[21] Appl. No.: **11,563**
[22] Filed: **Aug. 9, 1993**
[52] U.S. Cl. **D23/255**
[58] Field of Search **4/675-678; 137/801; D23/238-243, 255-257**

5,165,121 11/1992 McTargett et al. 137/801 X

OTHER PUBLICATIONS

Undated Altman's ad for its "S Spout" (admitted prior art).
Undated Jacob Delafon ad for its "Elite Faucet" (admitted prior art).
Undated Andre Collection ad for a "Sphinx" lavatory set (admitted prior art).

Primary Examiner—James R. Largen
Attorney, Agent, or Firm—Quarles & Brady

[57] CLAIM

The ornamental design for a spout, as shown and described.

DESCRIPTION

FIG. 1 is a perspective view taken from the top, front and right side of a spout showing my new design;
FIG. 2 is a perspective view taken from the bottom, front and left side thereof;
FIG. 3 is a front elevational view thereof;
FIG. 4 is a rear elevational thereof;
FIG. 5 is a right side elevational view thereof, the left side being the mirror image of the right side shown;
FIG. 6 is a top plan view thereof;
FIG. 7 is a bottom plan view thereof;
FIG. 8 is a cross-sectional view taken on line 8—8 of FIG. 5;
FIG. 9 is a cross-sectional view taken on line 9—9 of FIG. 5;
FIG. 10 is a cross-sectional view taken on line 10—10 of FIG. 5; and
FIG. 11 is a cross-sectional view taken on line 11—11 of FIG. 5.

[56] References Cited U.S. PATENT DOCUMENTS

D. 265,229	6/1980	Paul	D23/25
D. 273,512	4/1984	Arnolds	D23/242
D. 278,271	4/1985	Nieman	D23/255
D. 279,598	7/1985	Rademacher	D23/255
D. 291,236	8/1987	Delepine	D23/242
D. 298,274	10/1988	Fabian	D23/242
D. 316,137	4/1991	Razumov	D23/242
D. 322,840	12/1991	Rodstein	D23/255
D. 333,259	2/1993	McKeone	.	
D. 340,507	10/1993	McKeone	D23/255
D. 341,511	11/1993	McKeone	D6/550
D. 342,308	12/1993	McKeone	D23/257
D. 346,013	4/1994	McKeone	D23/255
4,624,415	11/1986	Hofstetler, Jr.	137/801 X
4,757,841	7/1988	Lucas	137/801
4,884,596	12/1989	Byers et al.	137/801

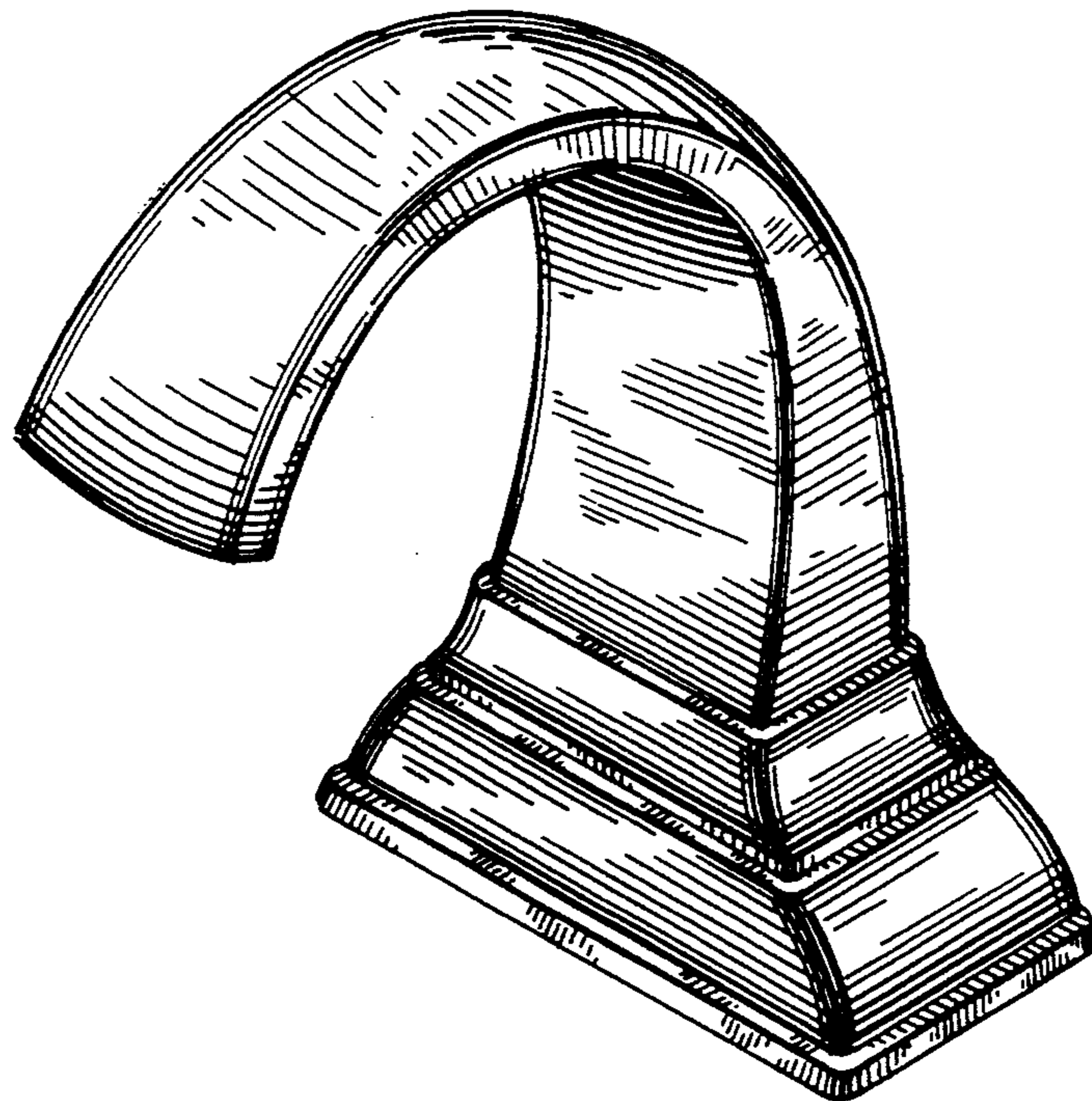

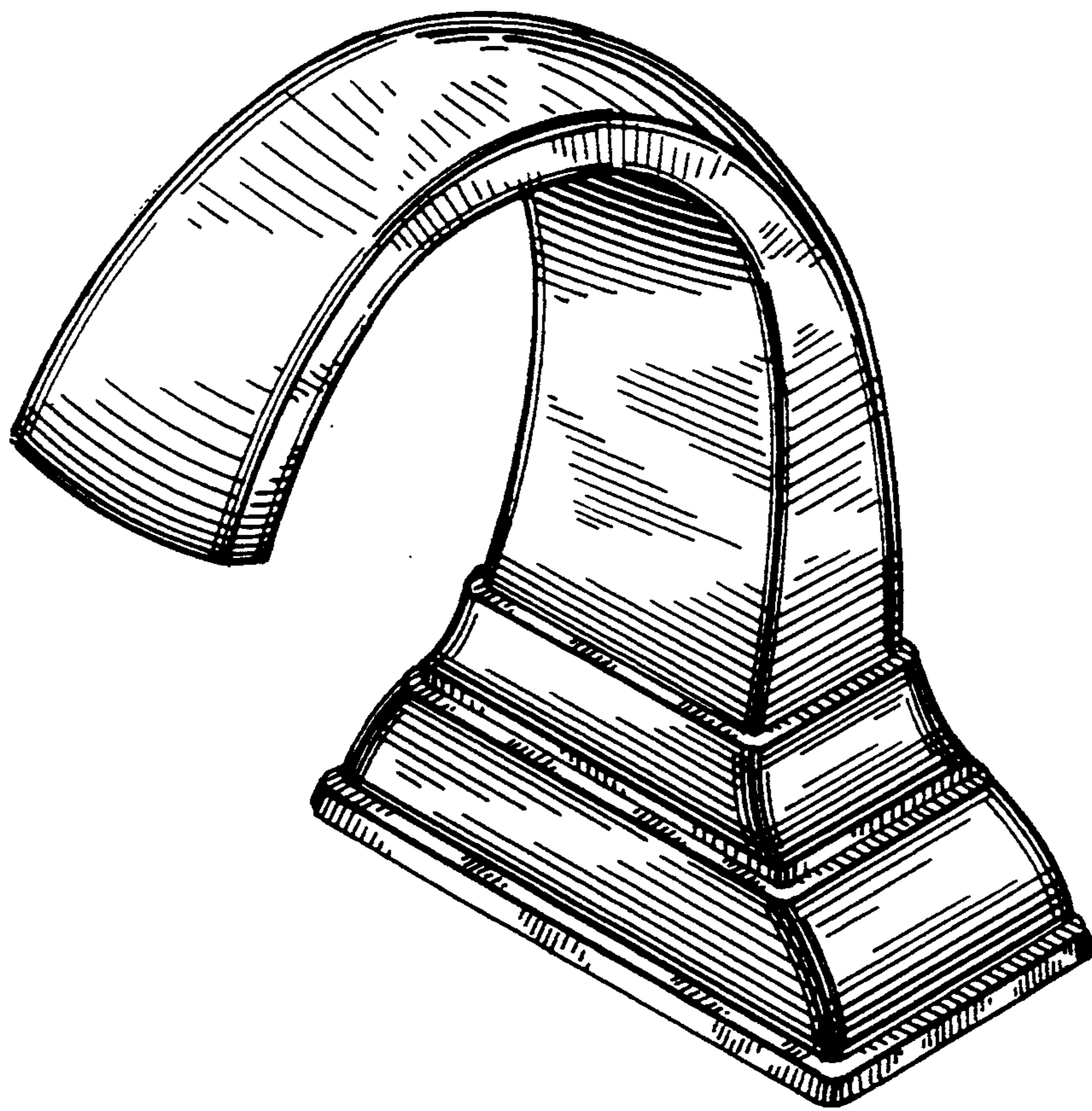

FIG. 1

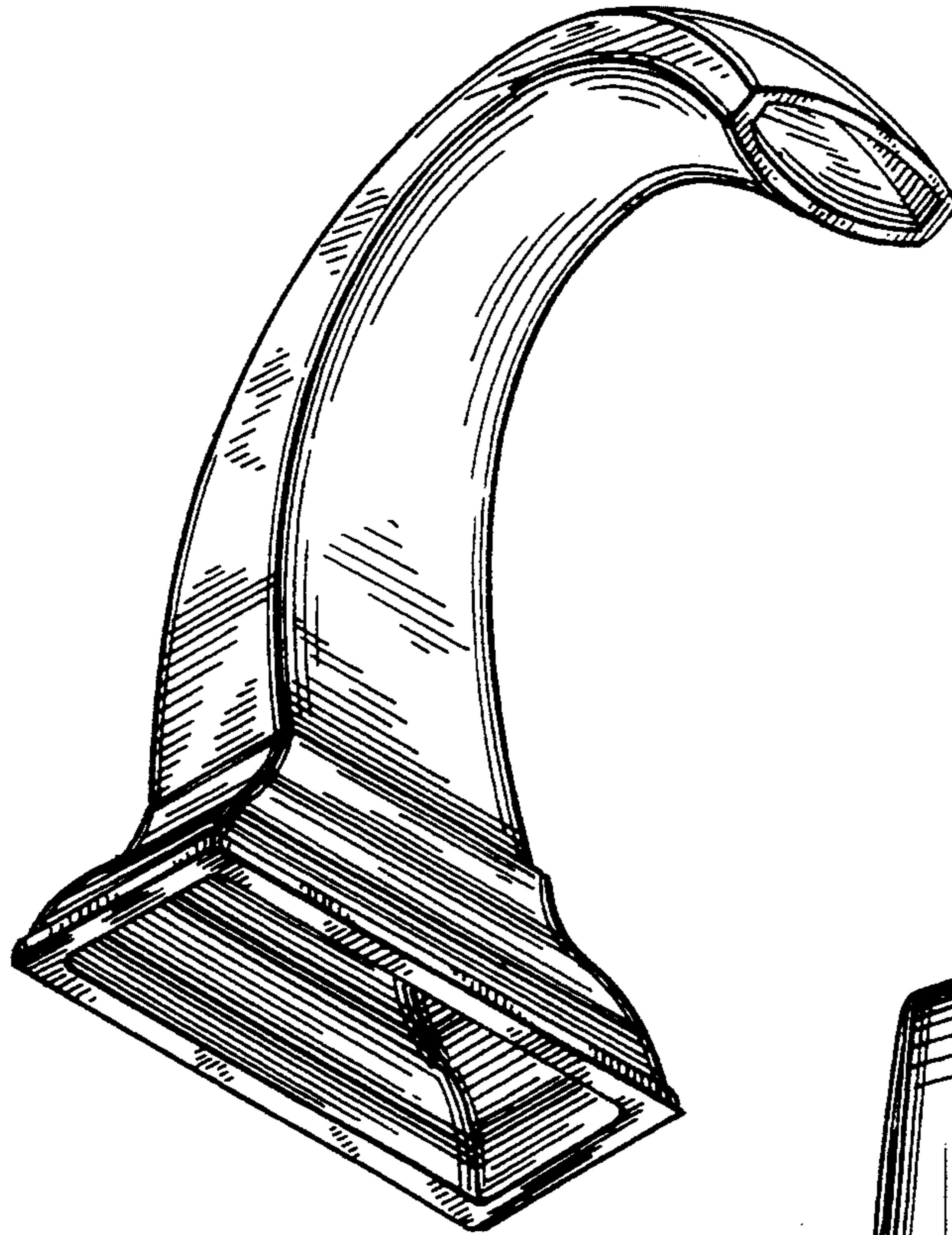

FIG. 2

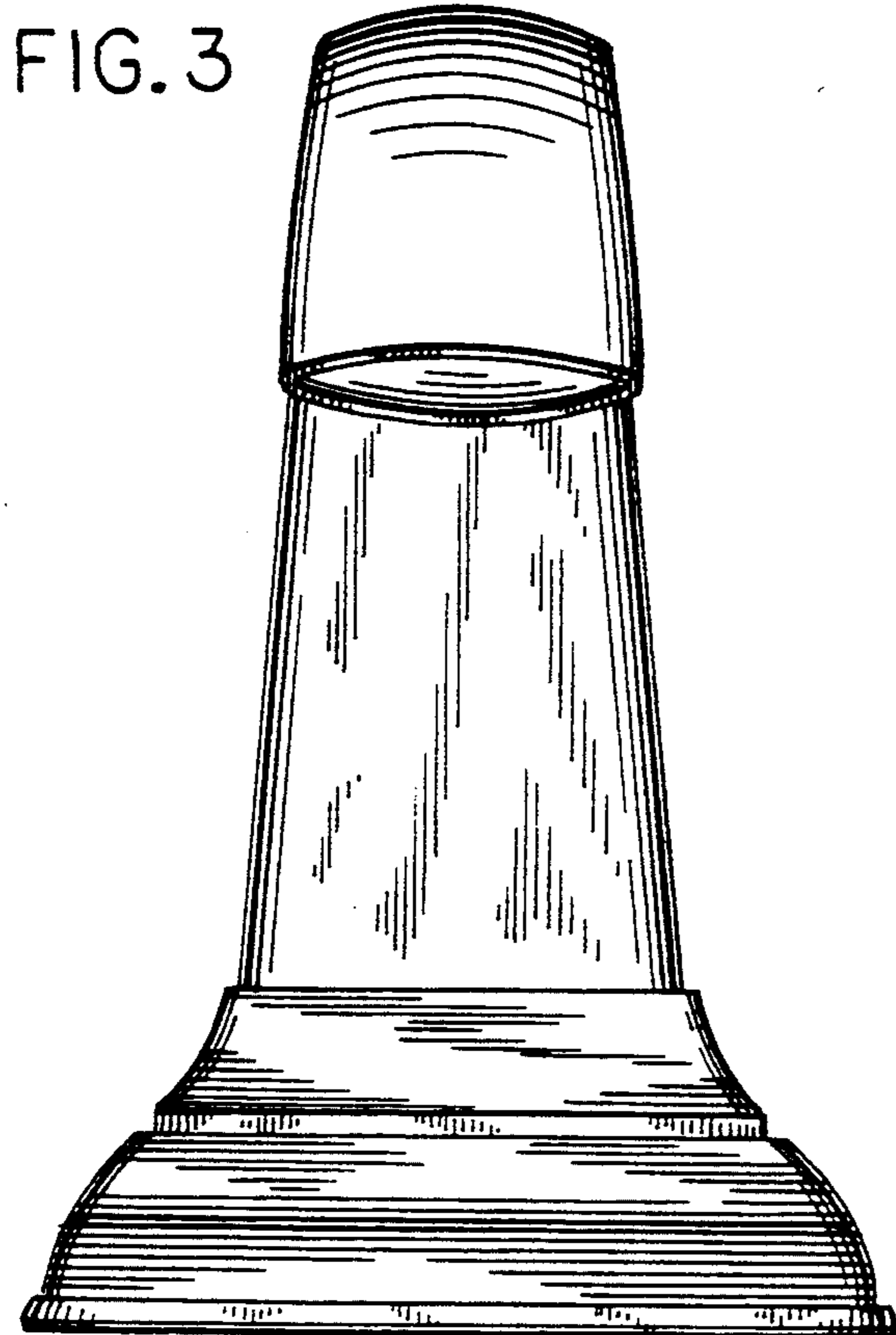

FIG. 3

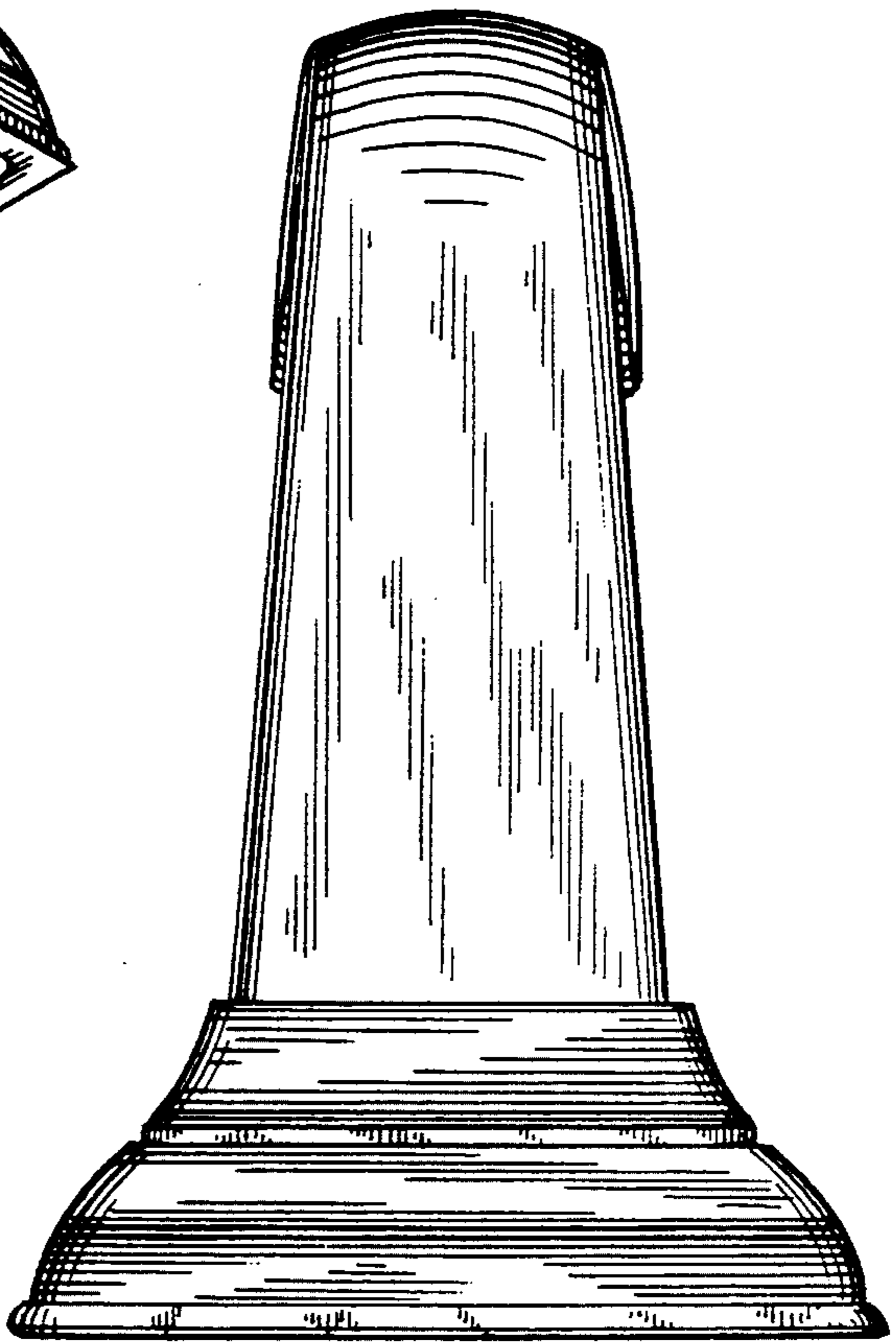

FIG. 4

FIG. 5

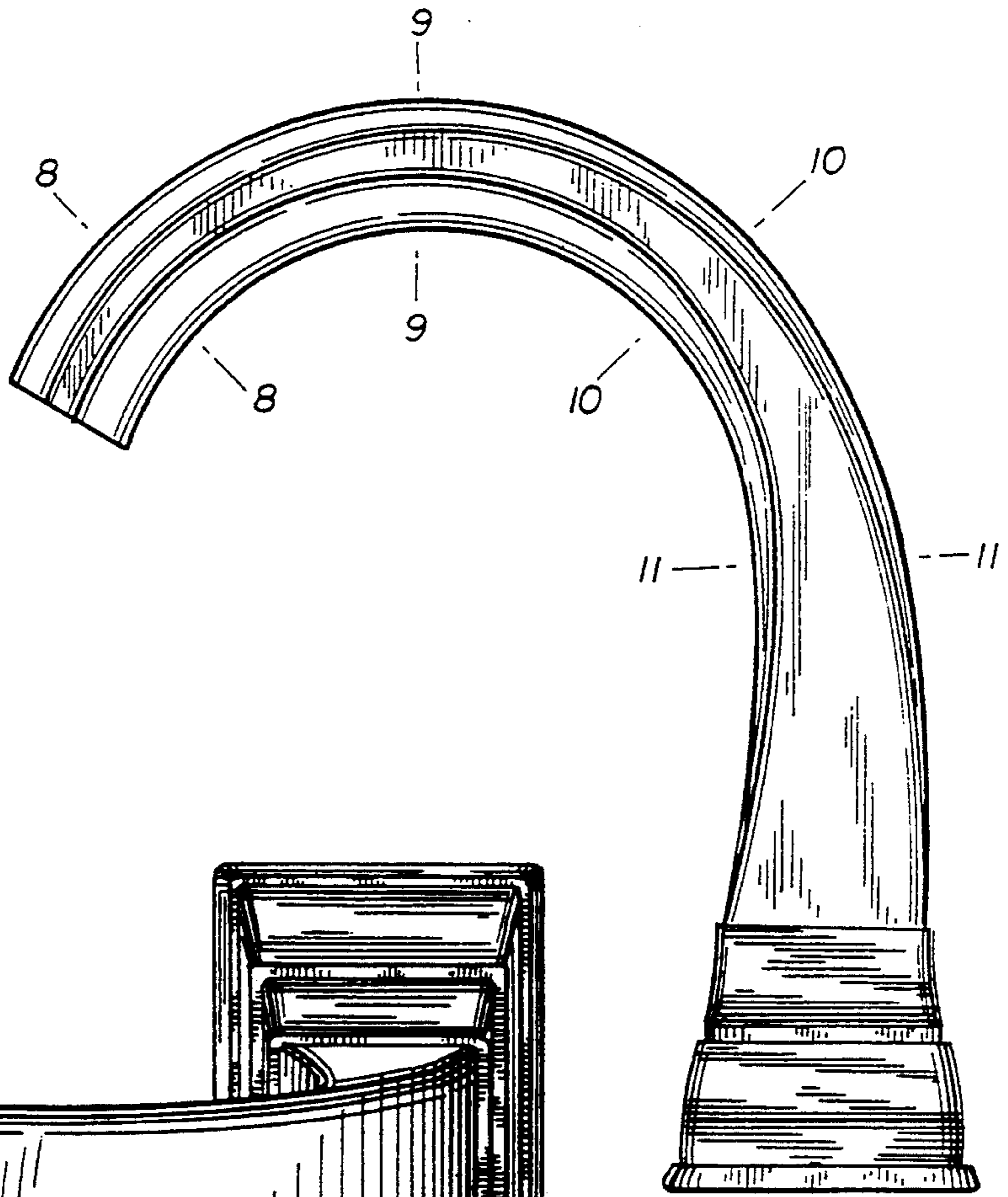

FIG. 6

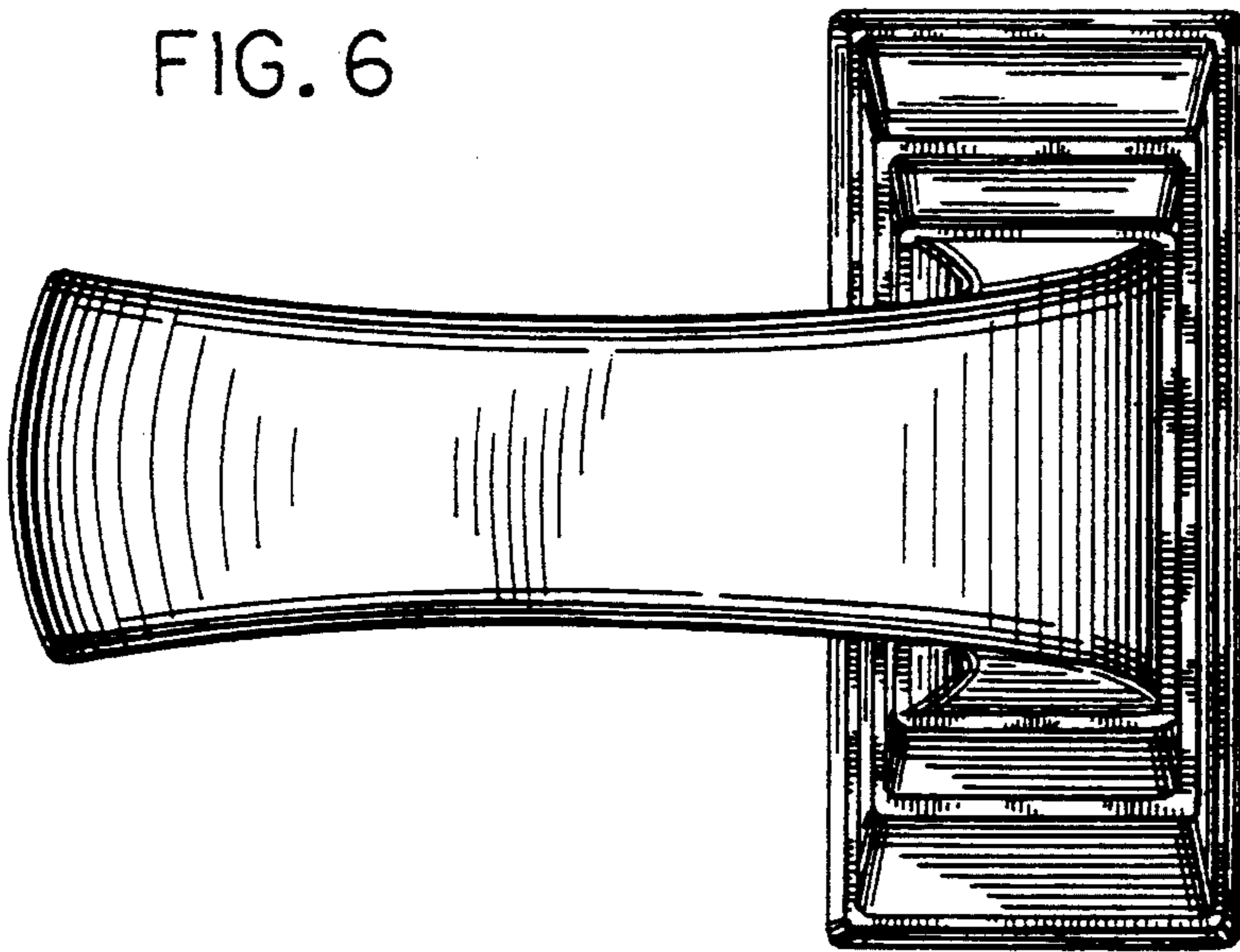
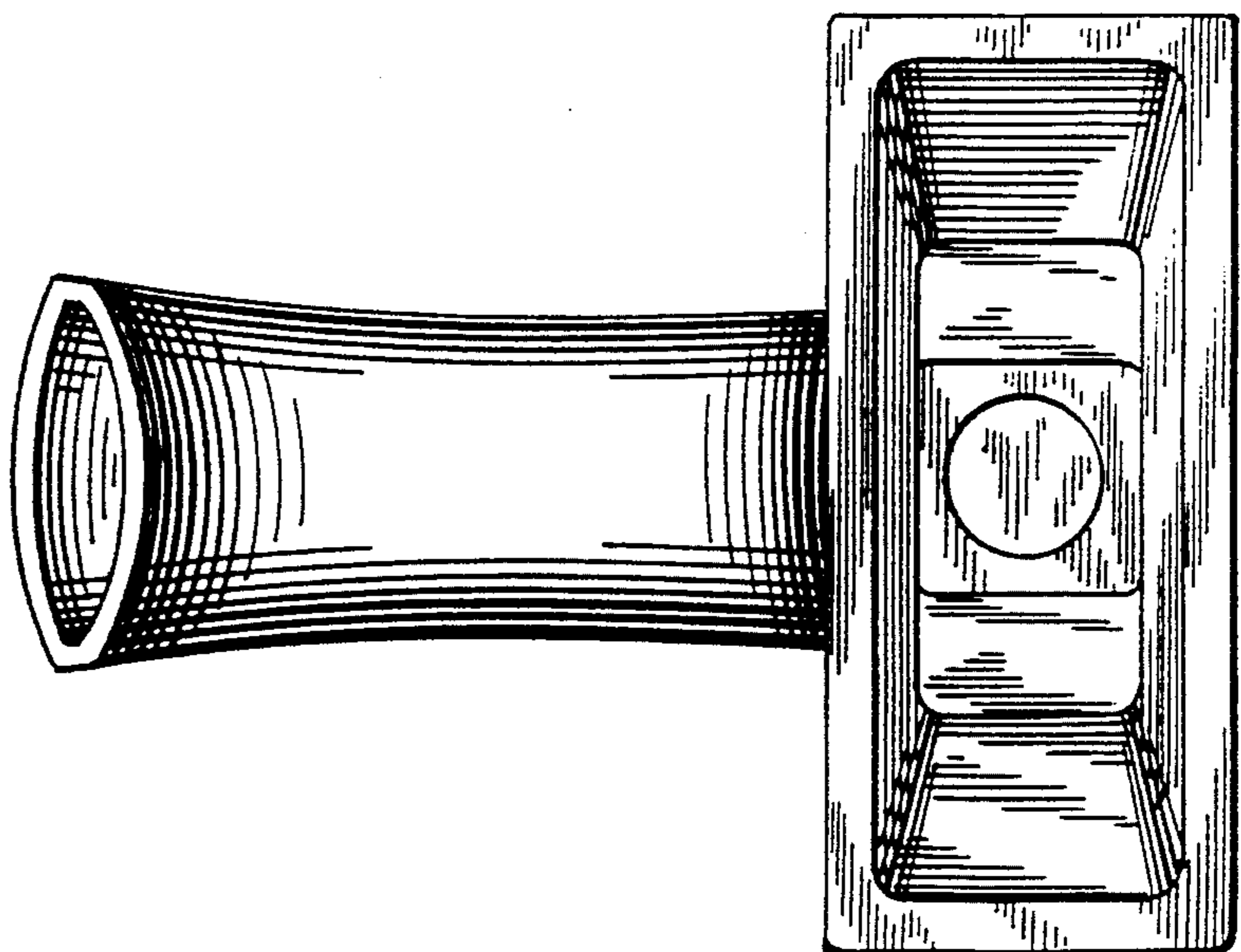

FIG. 7



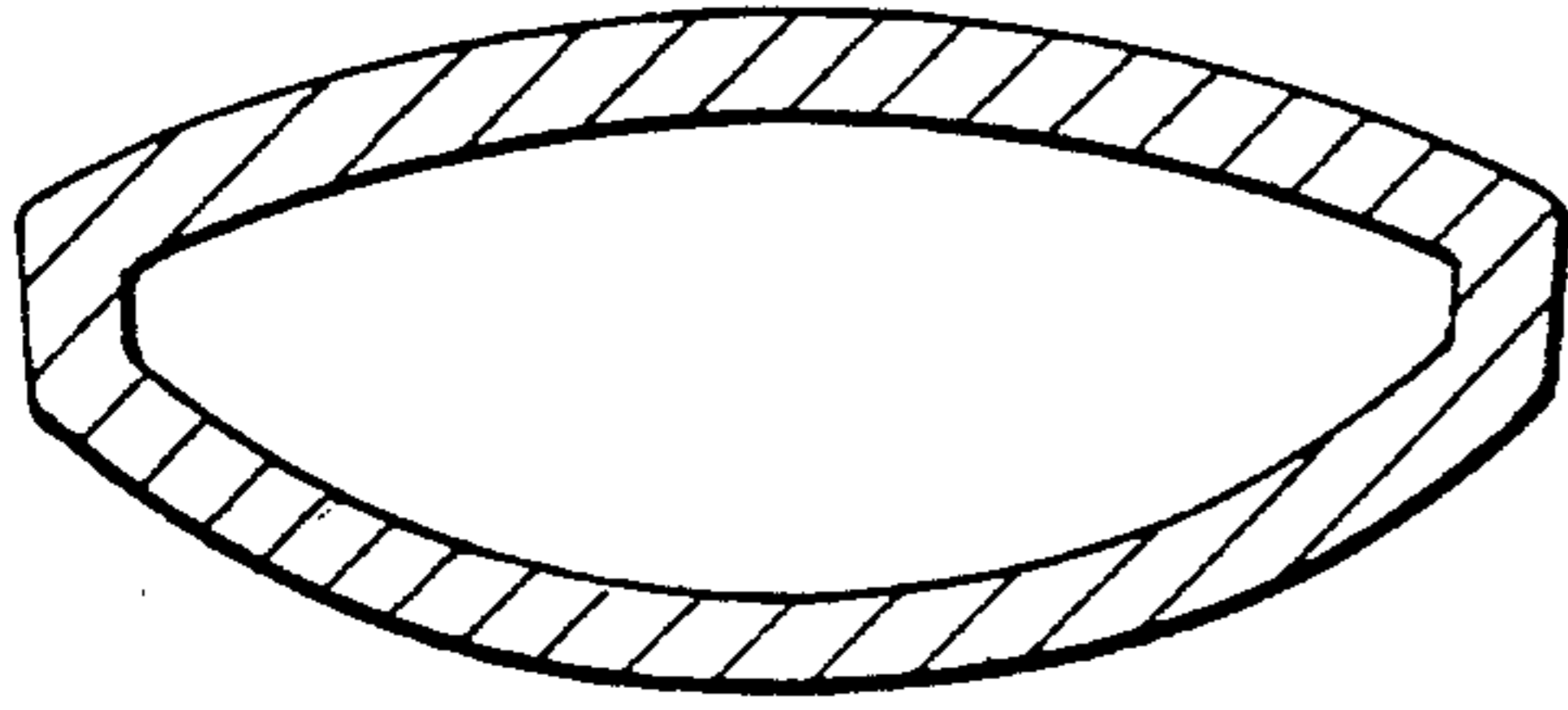

FIG. 8

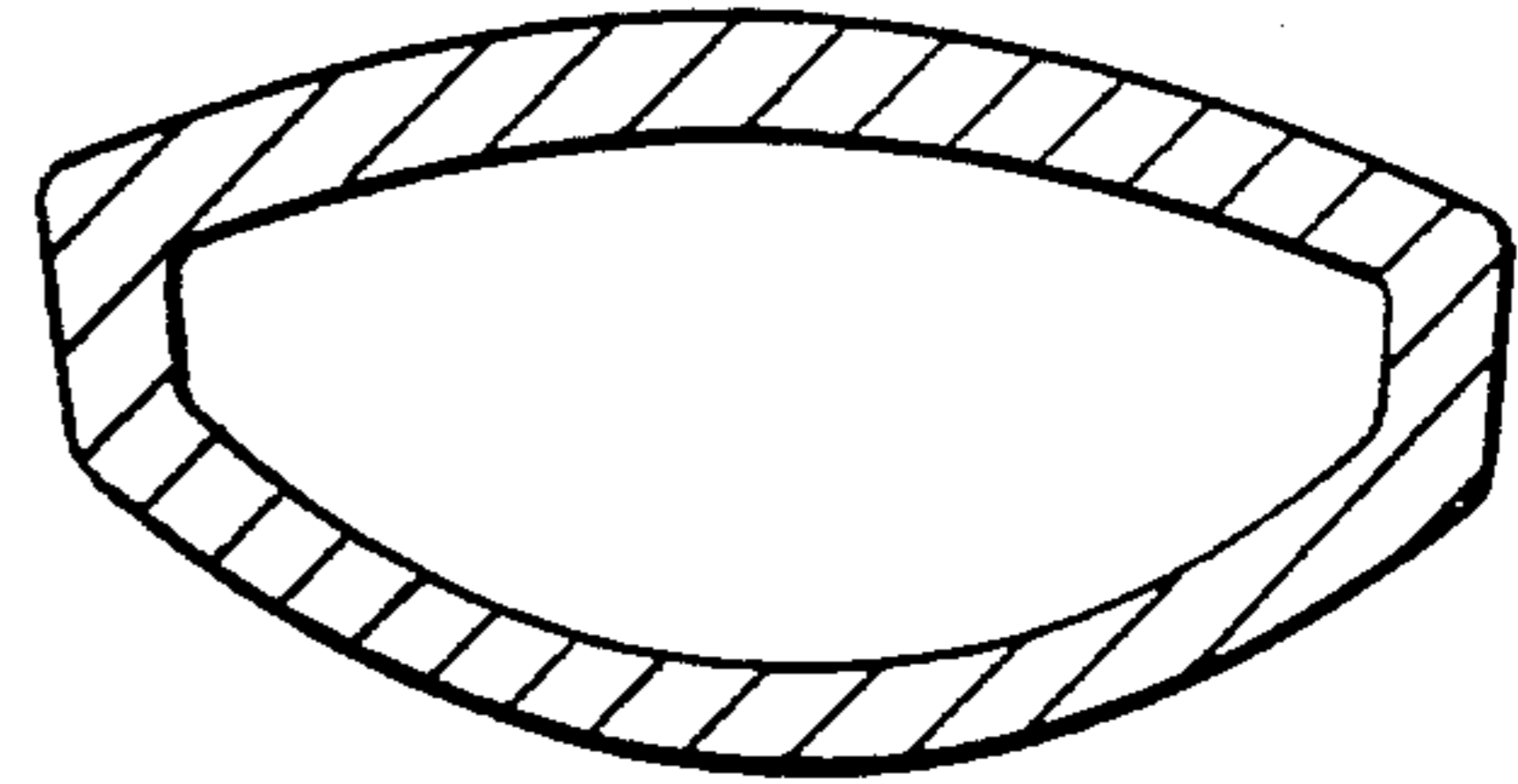

FIG. 9

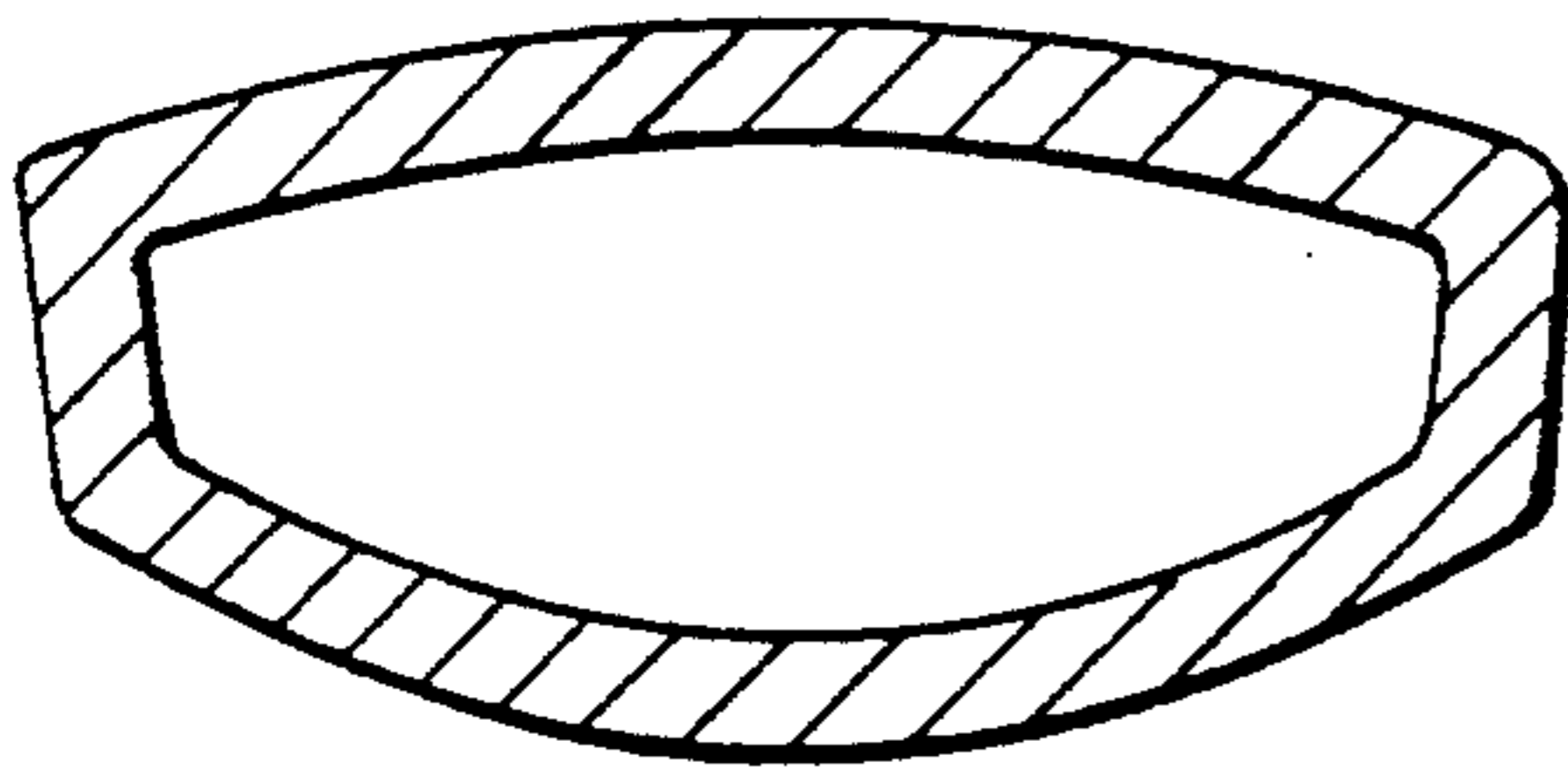

FIG. 10

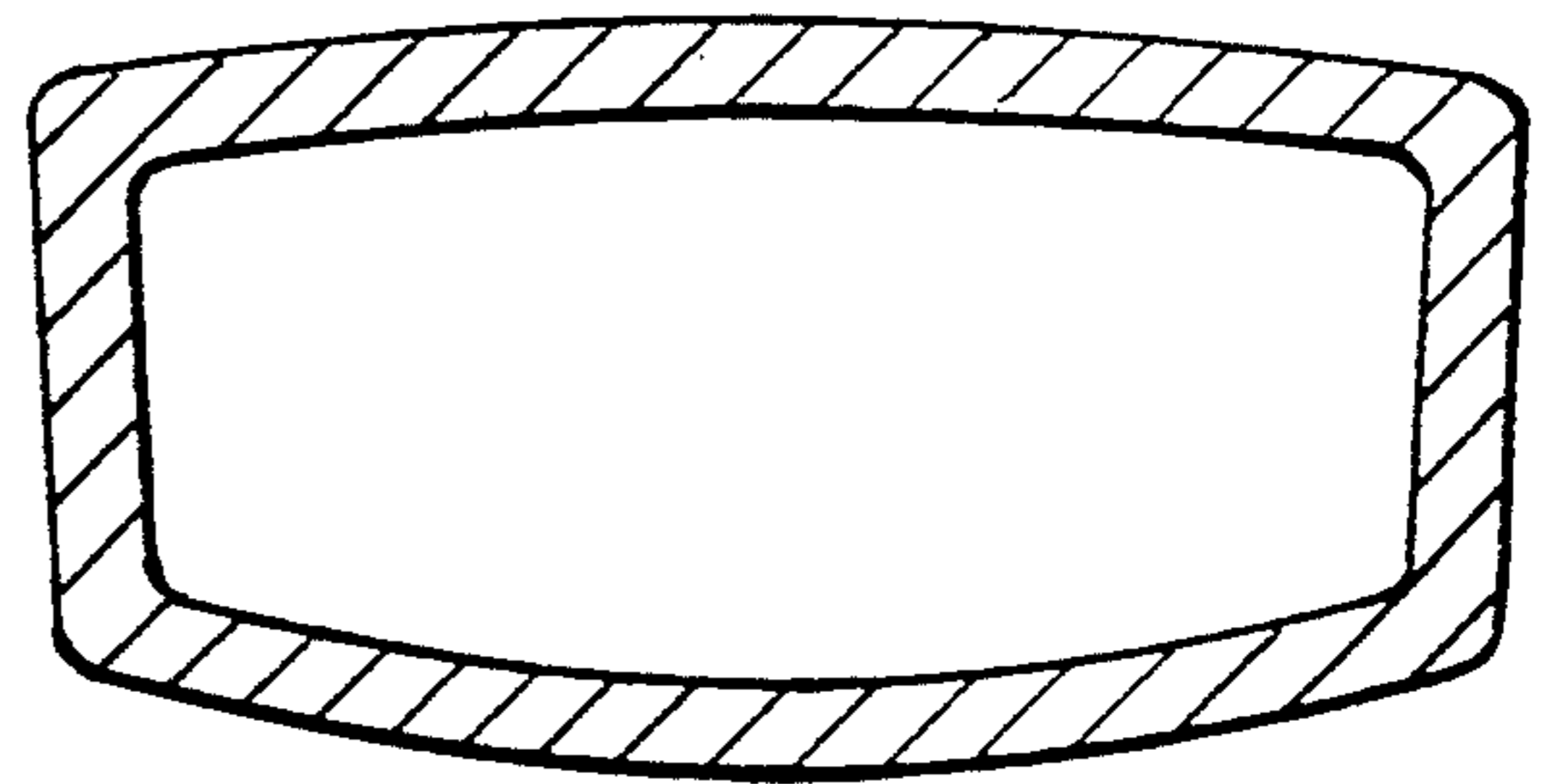

FIG. 11