



US00D352479S

United States Patent [19] Carlson

[11] Patent Number: **Des. 352,479**
[45] Date of Patent: **** Nov. 15, 1994**

[54] **PLANTER**

[75] Inventor: **Arthur R. Carlson, Rowville, Australia**

[73] Assignee: **Bemis Manufacturing Company, Sheboygan Falls, Wis.**

[*] Notice: The portion of the term of this patent subsequent to Apr. 19, 2008 has been disclaimed.

[**] Term: **14 Years**

[21] Appl. No.: **11,814**

[22] Filed: **Aug. 13, 1993**

[52] U.S. Cl. **D11/153; D11/143**

[58] Field of Search **D7/555; 47/66, 71; D11/143, 153, 152**

90287	4/1985	Australia .
90289	4/1985	Australia .
90291	4/1985	Australia .
94178	11/1986	Australia .
94632	1/1987	Australia .
94633	1/1987	Australia .
95997	3/1987	Australia .
96249	4/1987	Australia .
96250	4/1987	Australia .
97364	8/1987	Australia .
98993	12/1987	Australia .
99707	2/1988	Australia .
15065	7/1977	New Zealand .
15178	10/1977	New Zealand .
15180	10/1977	New Zealand .
15245	11/1977	New Zealand .
15246	11/1977	New Zealand .
18581	9/1983	New Zealand .
18582	9/1983	New Zealand .

OTHER PUBLICATIONS

Poppytrail Pottery Advertisement By Metlox Manufacturing Co., p. 8.

Primary Examiner—Alan P. Douglas

Assistant Examiner—S. Snapp

Attorney, Agent, or Firm—Michael, Best & Friedrich

[57] CLAIM

The ornamental design for a planter, as shown.

DESCRIPTION

FIG. 1 is a perspective view from the front and above; FIG. 2 is a perspective view from the front and above with the parts separated; FIG. 3 is a perspective view from the rear and below with the parts separated; FIG. 4 is a top plan view; FIG. 5 is a rear view; FIG. 6 is a vertical cross-sectional view along the lines of and in the direction of arrows 6—6 in FIG. 4; and, FIG. 7 is an underneath view.

[56] References Cited

U.S. PATENT DOCUMENTS

D. 288,793	3/1987	Carlson	D11/153
D. 288,794	3/1987	Carlson	D11/153
D. 296,425	6/1988	Carlson	D11/152
D. 297,319	3/1988	Carlson	D11/152
D. 300,732	4/1989	Carlson	D11/152
D. 313,203	12/1990	Carlson	D11/153

FOREIGN PATENT DOCUMENTS

69505	7/1977	Australia .
69915	7/1977	Australia .
78936	3/1980	Australia .
79917	7/1980	Australia .
79915	9/1980	Australia .
79916	9/1980	Australia .
81174	3/1981	Australia .
81777	6/1981	Australia .
81778	6/1981	Australia .
83116	2/1982	Australia .
83115	5/1982	Australia .

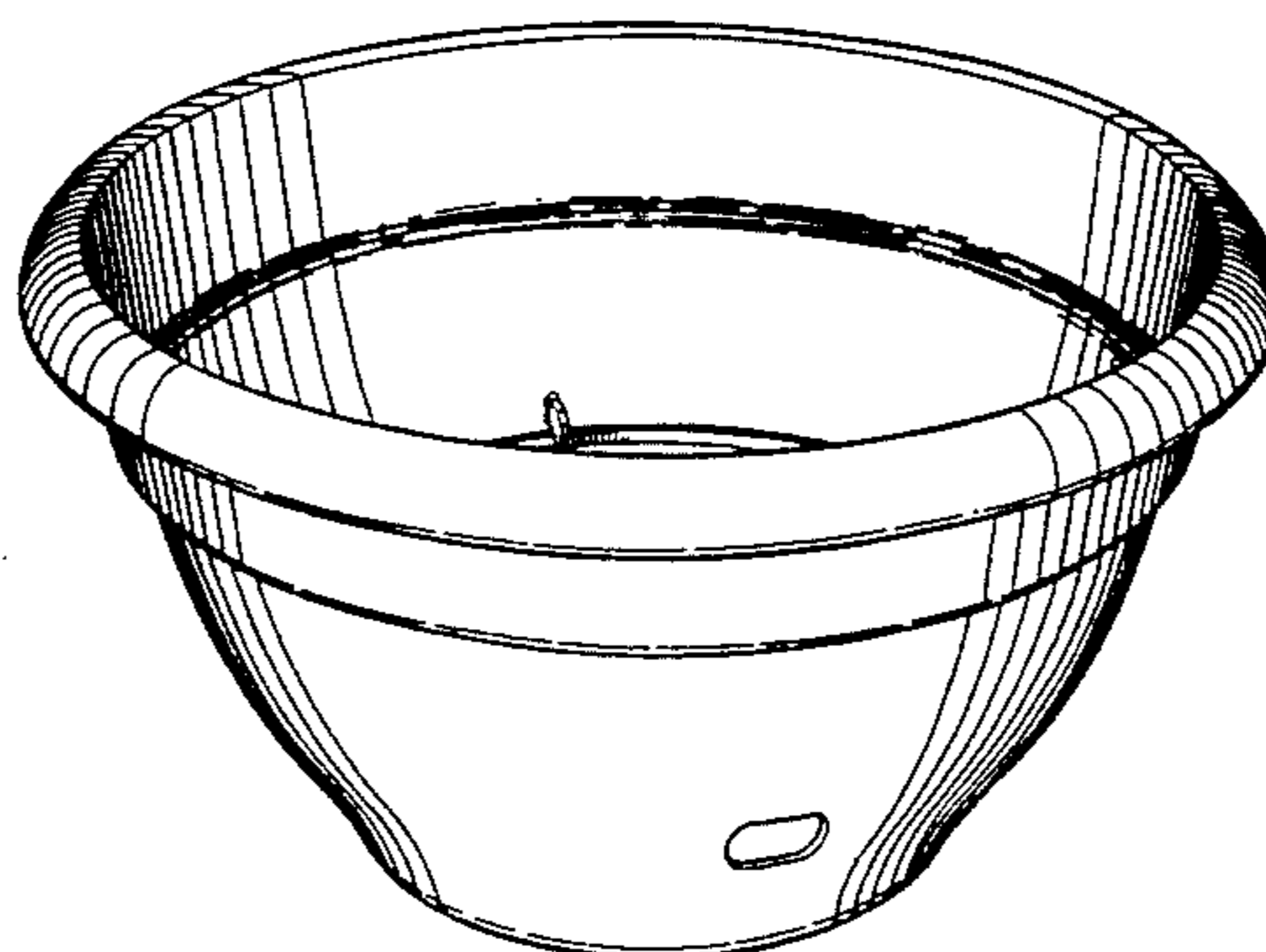
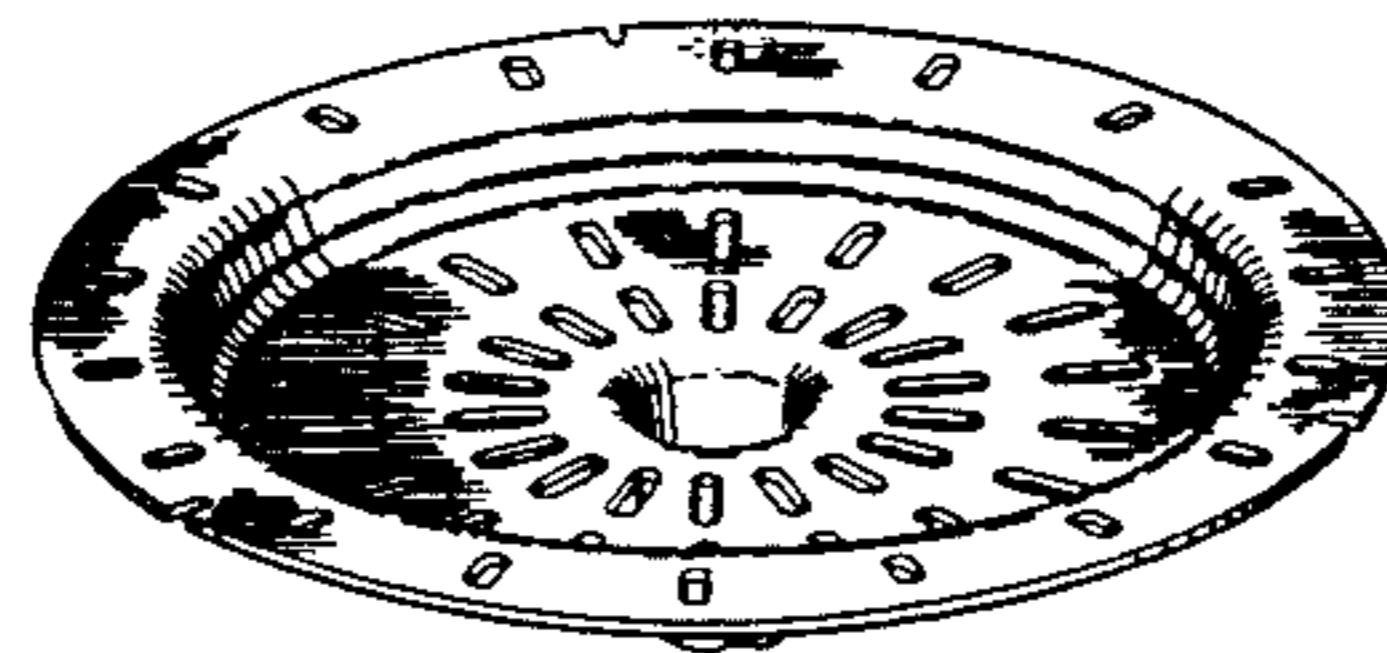

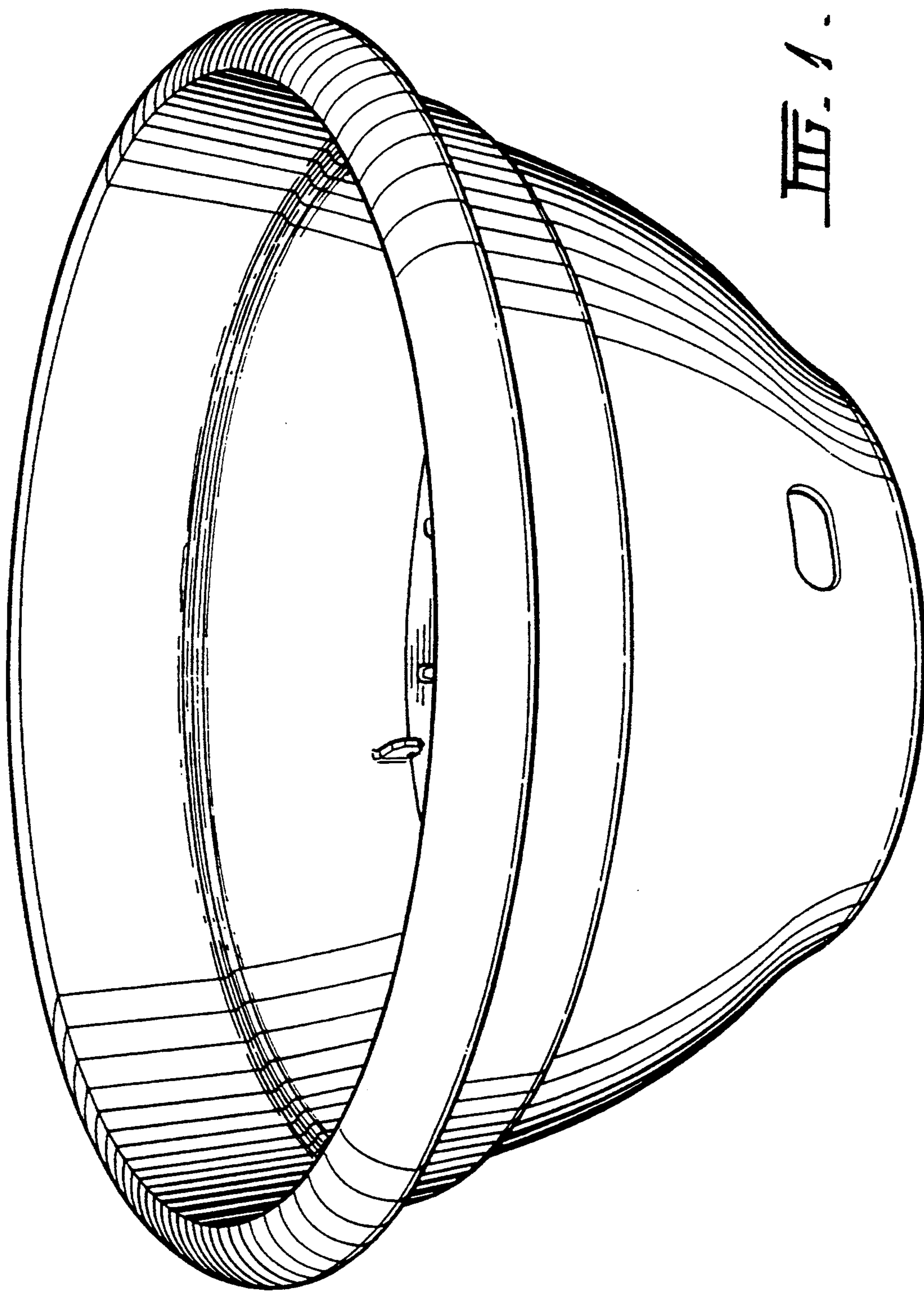
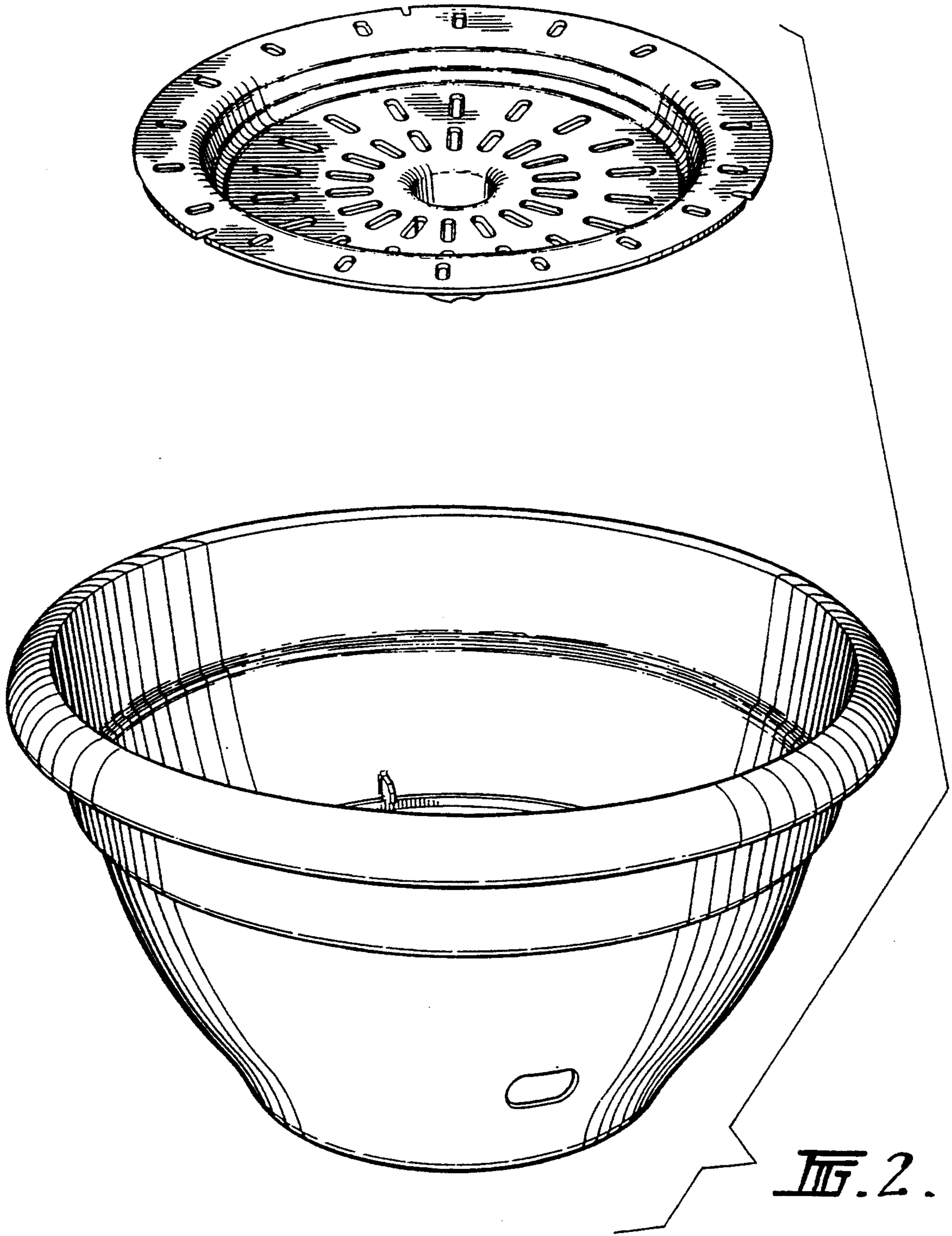

FIG. 1.



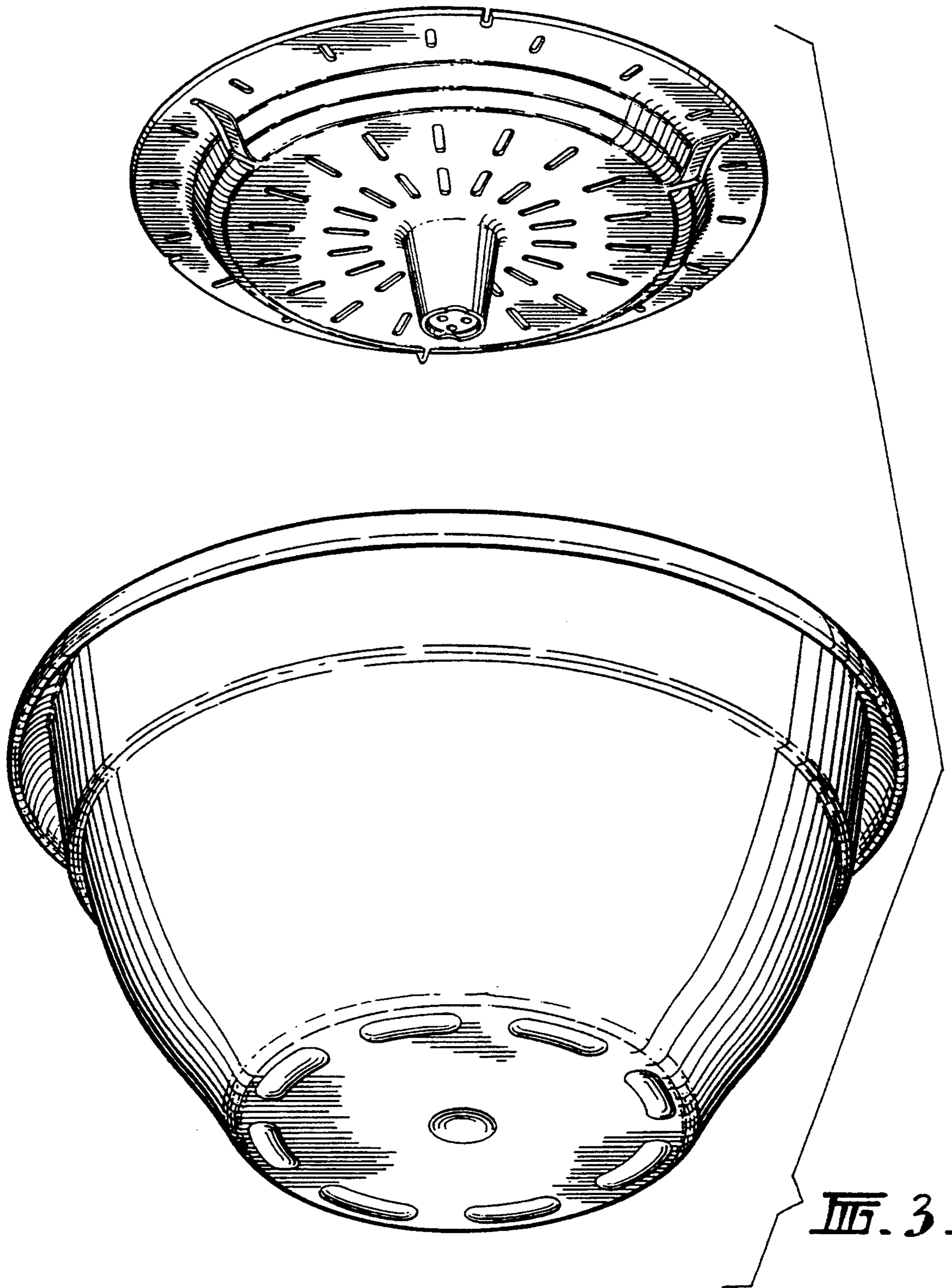

FIG. 3.

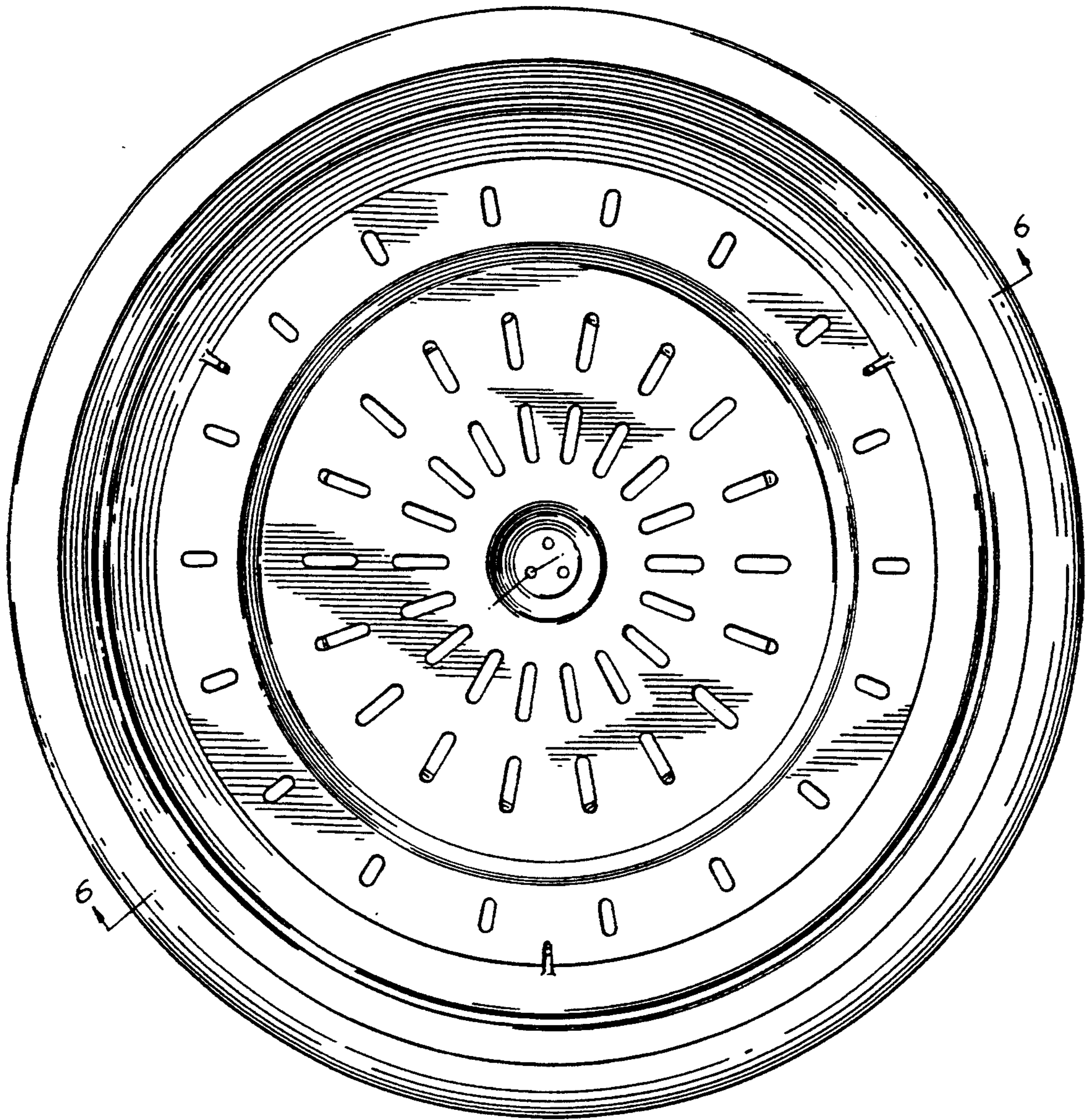

FIG. 4.

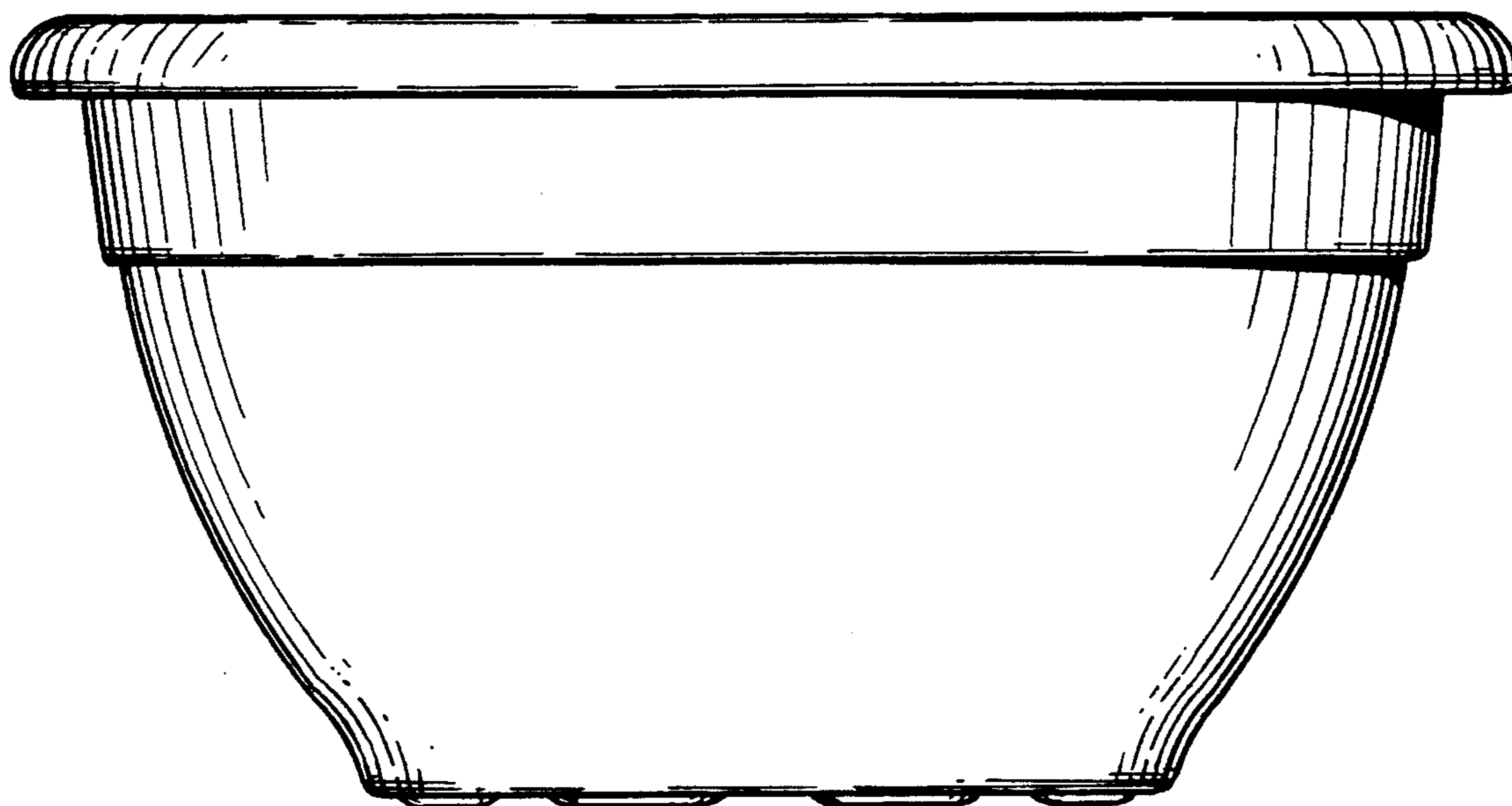

FIG. 5.

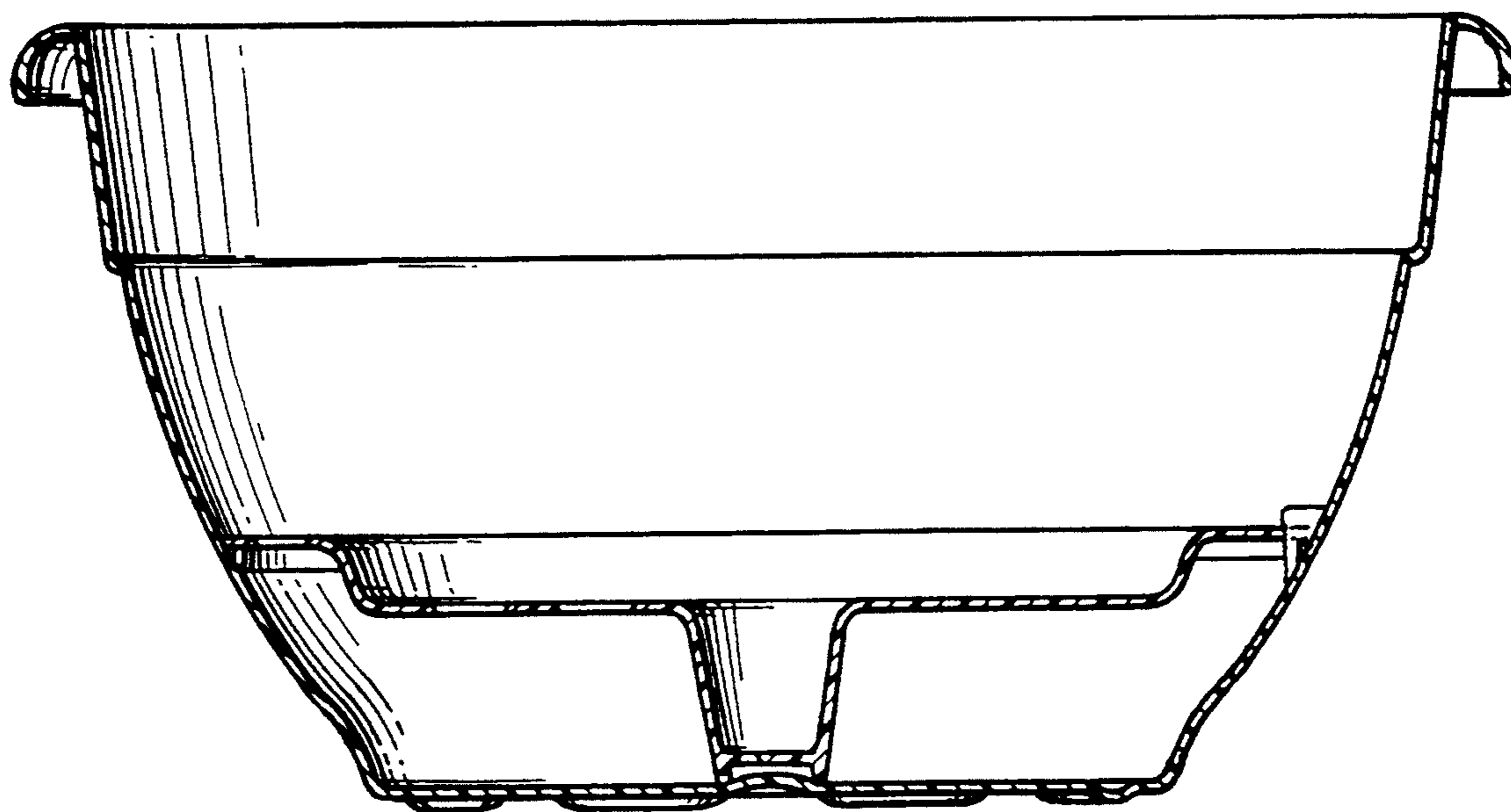

FIG. 6.

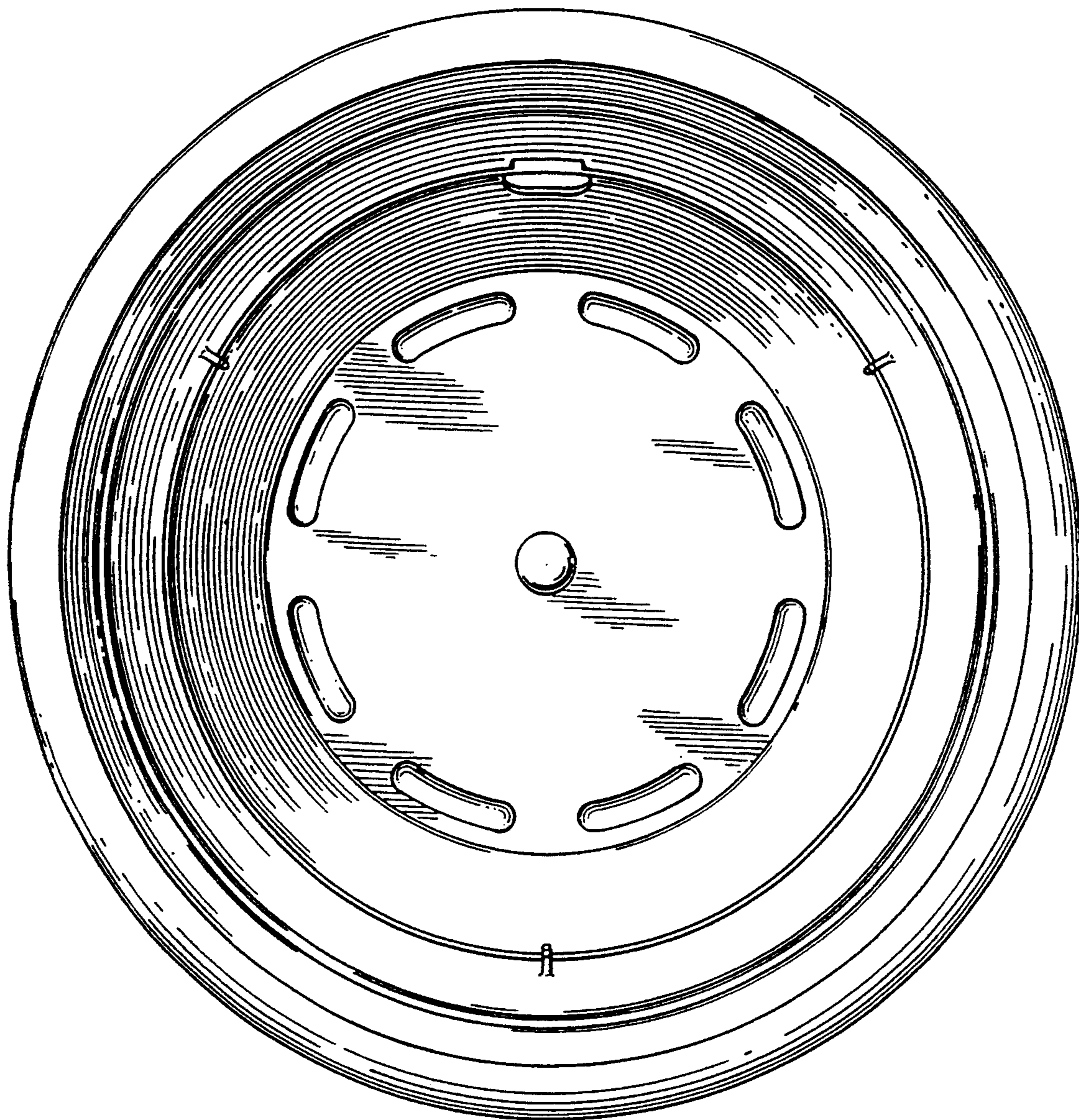

FIG. 7.