



US00D352425S

# United States Patent [19]

[11] Patent Number: Des. 352,425

Daenen et al.

[45] Date of Patent: \*\* Nov. 15, 1994

## [54] FOOD STORAGE CONTAINER

[75] Inventors: **Robert H. C. M. Daenen**, Essene;  
**Pieter K. J. DeCoster**, Aalst, both of Belgium

D. 276,400 11/1984 Daenen .  
D. 279,253 6/1985 Daenen .  
D. 312,968 12/1990 Wolff .  
2,606,586 8/1952 Hill .

[73] Assignee: **Dart Industries Inc.**, Deerfield, Ill.

[\*\*] Term: **14 Years**

[21] Appl. No.: **18,870**

[22] Filed: **Feb. 17, 1994**

## OTHER PUBLICATIONS

Brabantia Product Catalog 83/84, four pages—pp. 4 and 11 plus a sheet identified as “Sortiment New Forest” and a sheet identified as Katalog 83/84, Canisters.

*Primary Examiner*—Terry A. Wallace  
*Attorney, Agent, or Firm*—John A. Doninger

## Related U.S. Application Data

[63] Continuation of Ser. No. 2,878, Dec. 22, 1992, abandoned.

[52] U.S. Cl. .... **D7/602**

[58] Field of Search ..... **D7/538-542,**  
**D7/601-602, 612-615, 629; D9/424-425,**  
**430-432**

## [57] CLAIM

The ornamental design for a food storage container, as shown and described.

## DESCRIPTION

FIG. 1 is a top perspective view of a food storage container, showing our new design;  
FIG. 2 is a front elevational view thereof;  
FIG. 3 is a side elevational view thereof;  
FIG. 4 is a top plan view thereof;  
FIG. 5 is a bottom plan view thereof;  
FIG. 6 is a cross-sectional view thereof on line 6—6 of FIG. 4; and,  
FIG. 7 is a cross-sectional view thereof on line 7—7 in FIG. 4.

## [56] References Cited

### U.S. PATENT DOCUMENTS

- D. 158,107 4/1950 Lidholm .
- D. 234,574 3/1975 Schimkat .
- D. 254,180 2/1980 Morin .
- D. 256,107 8/1980 Tayebi .
- D. 261,717 11/1981 Mont .

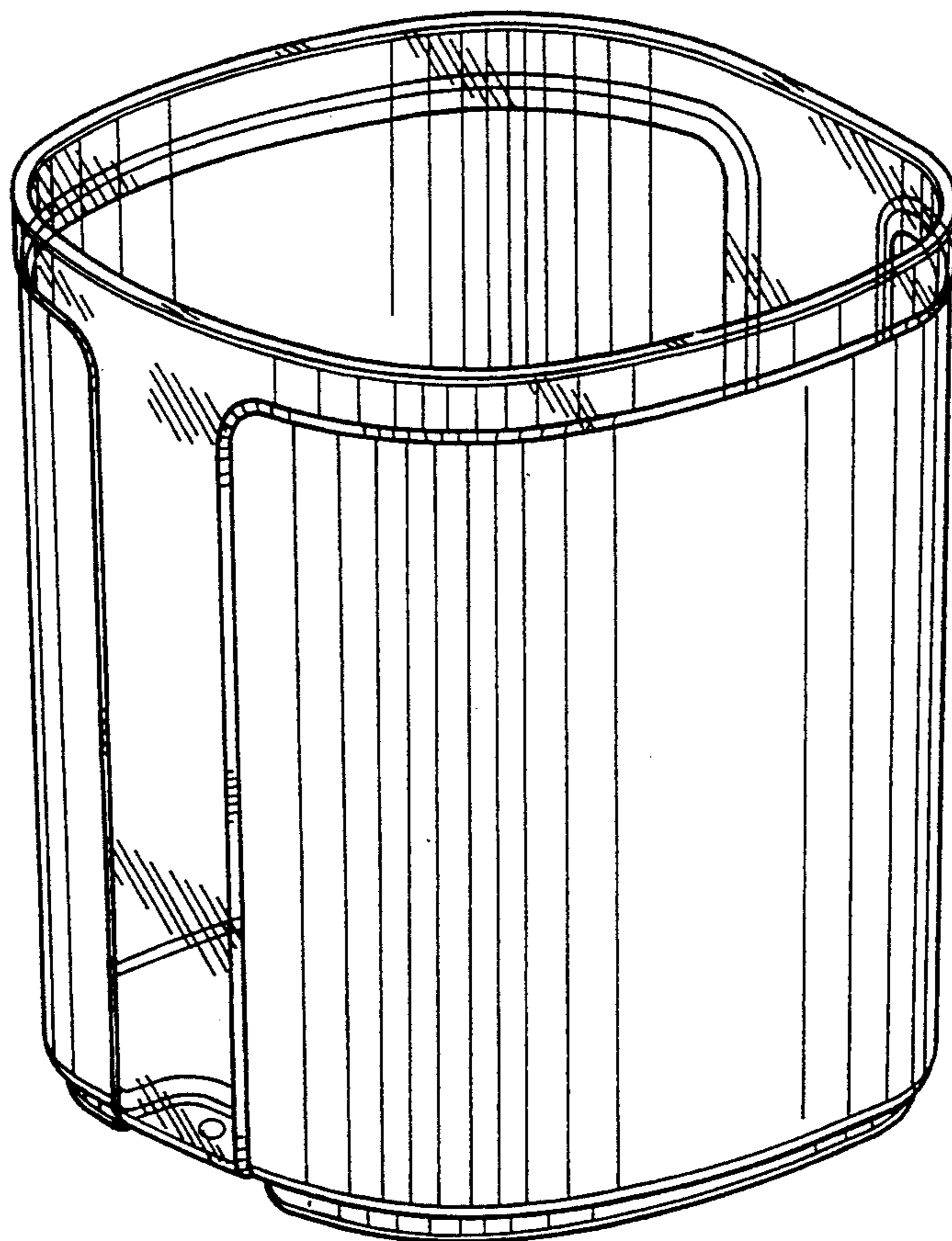

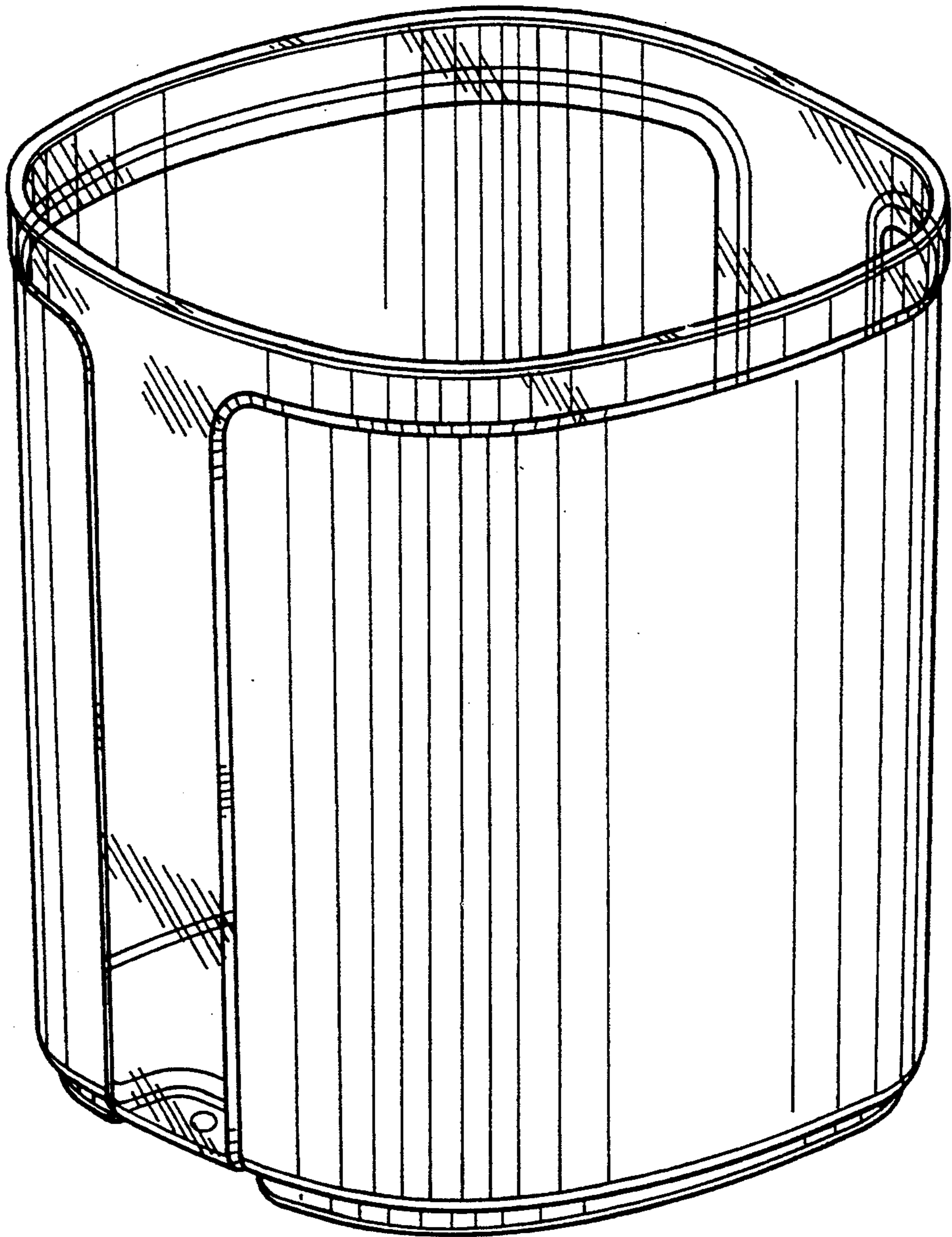

FIG. 1

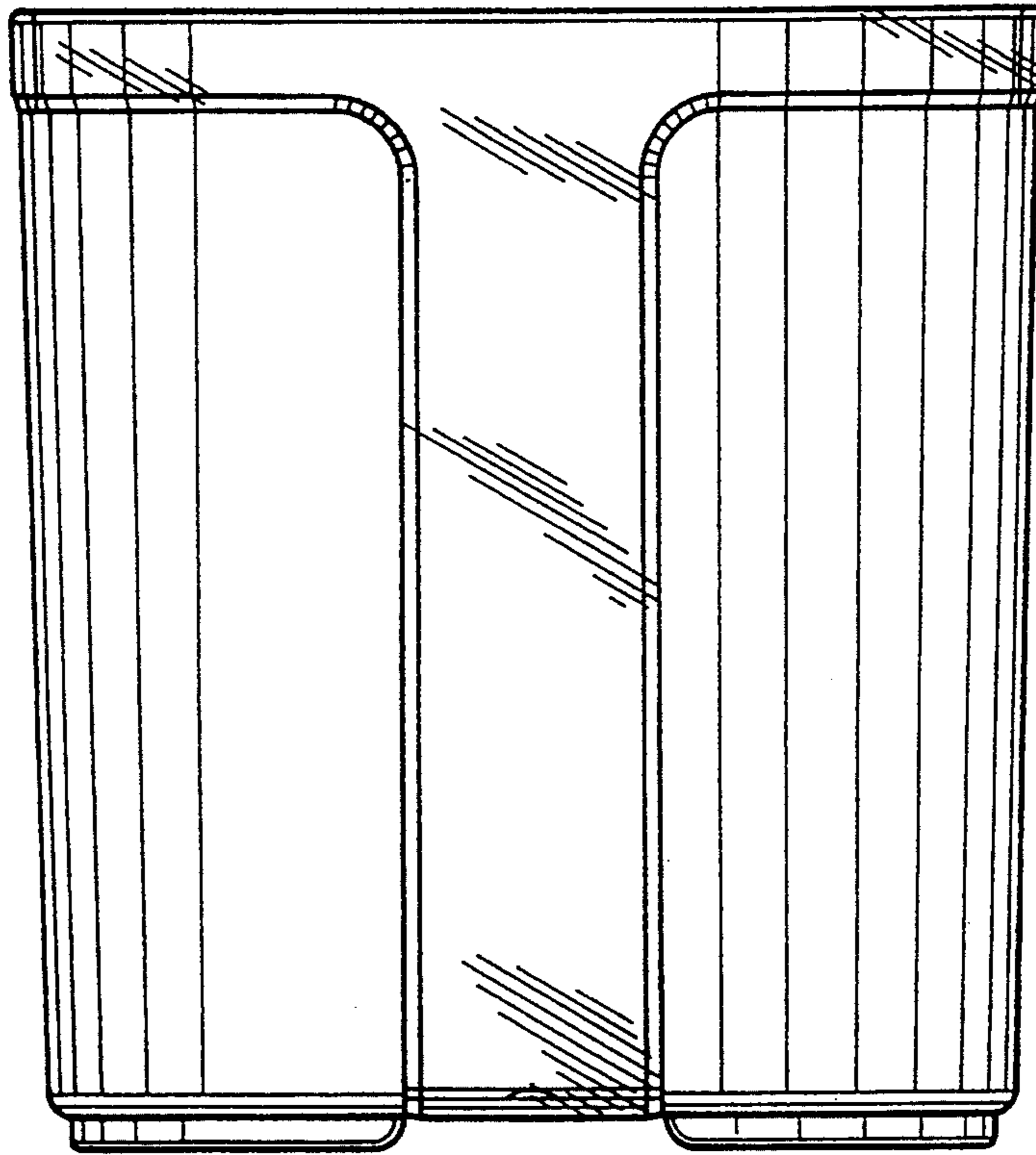

FIG. 2

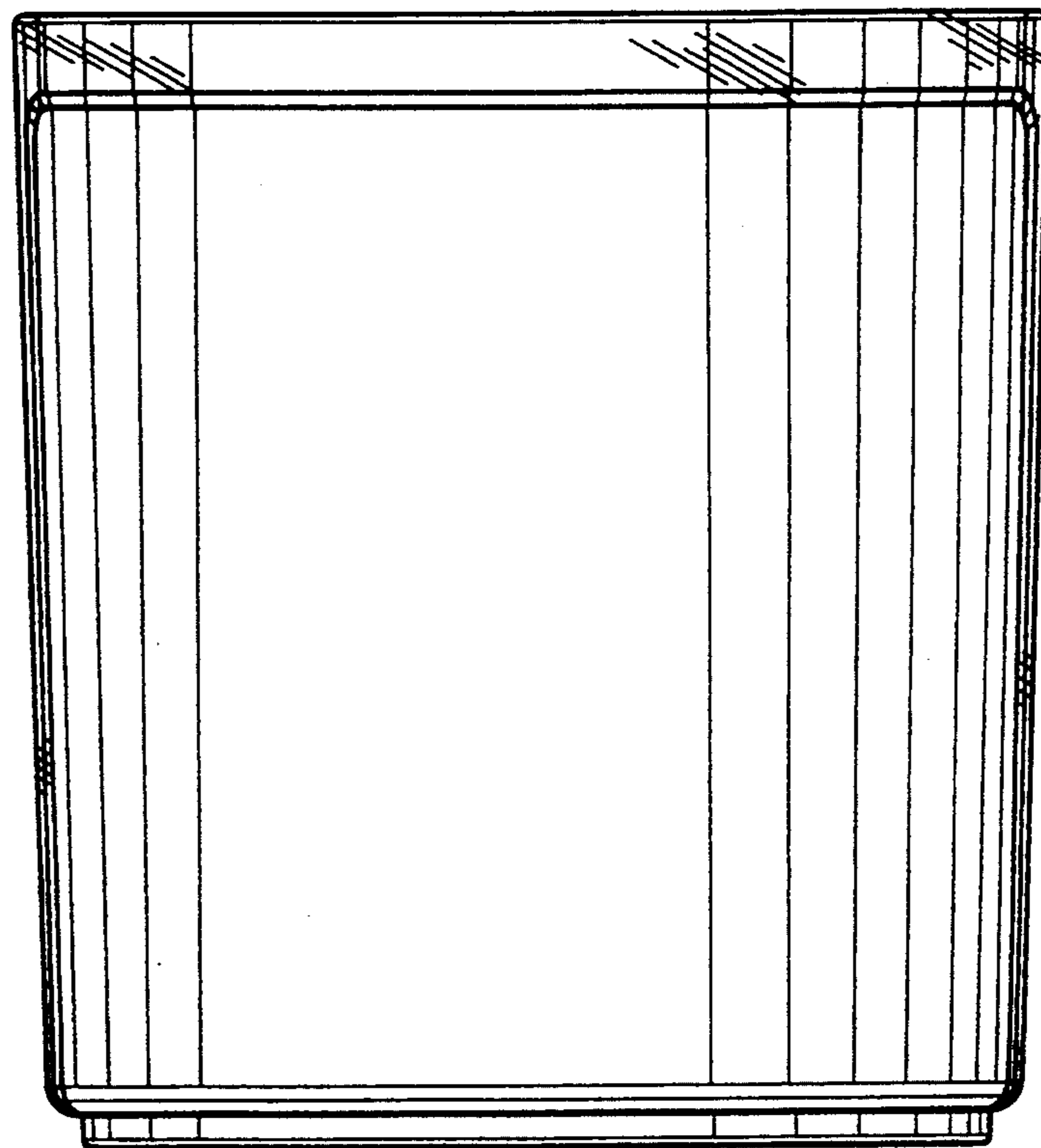

FIG. 3

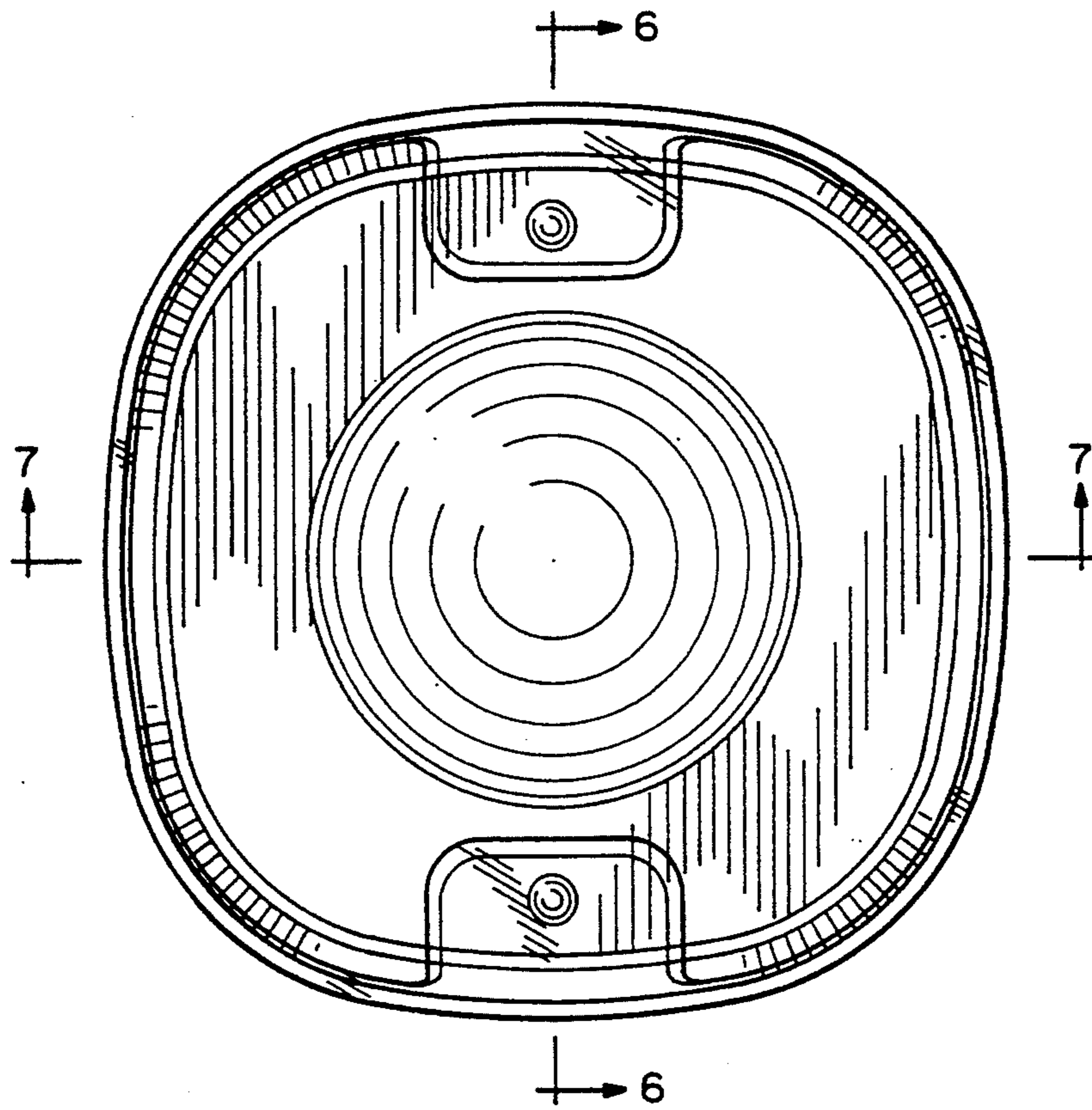

FIG. 4

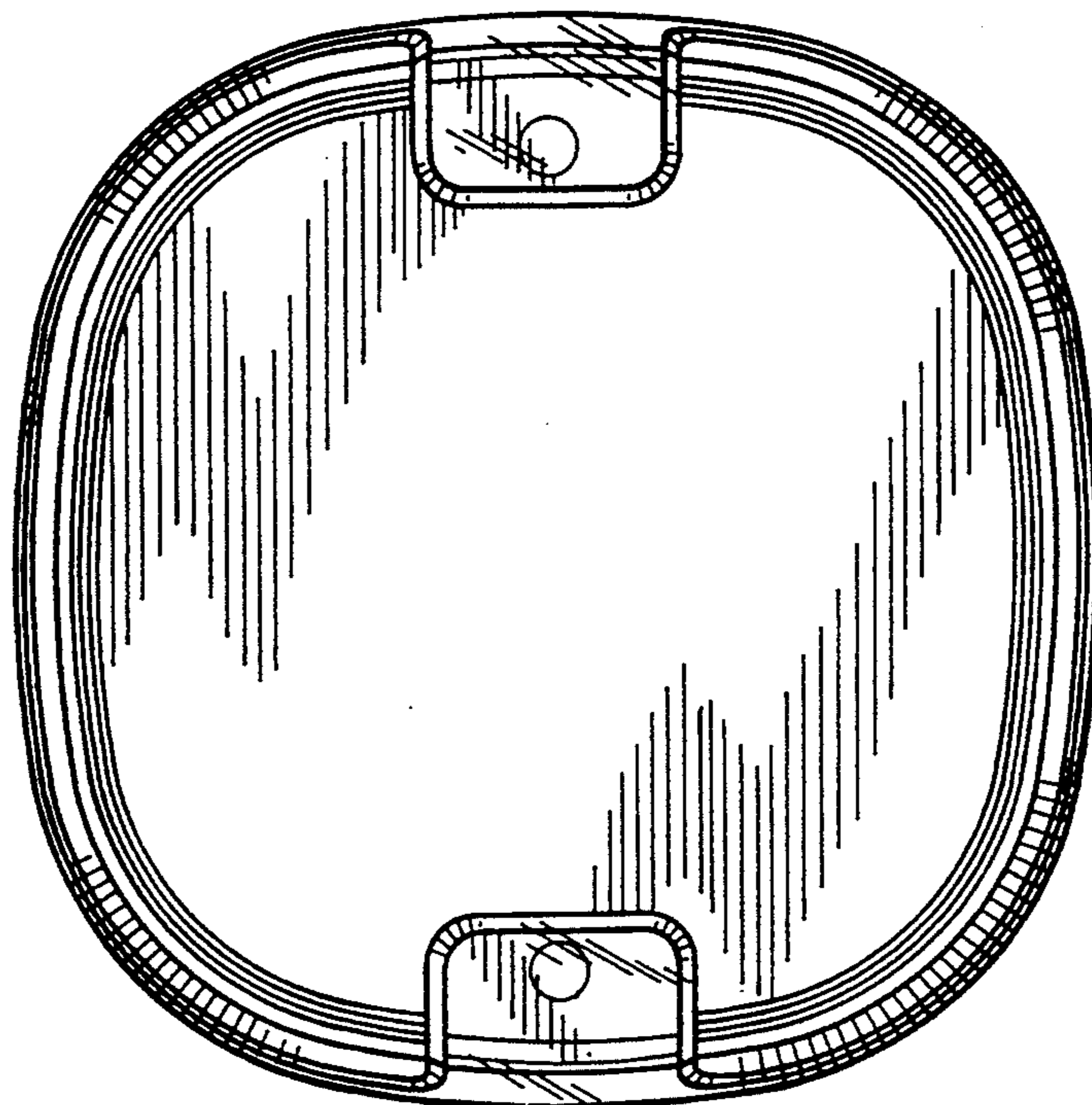

FIG. 5

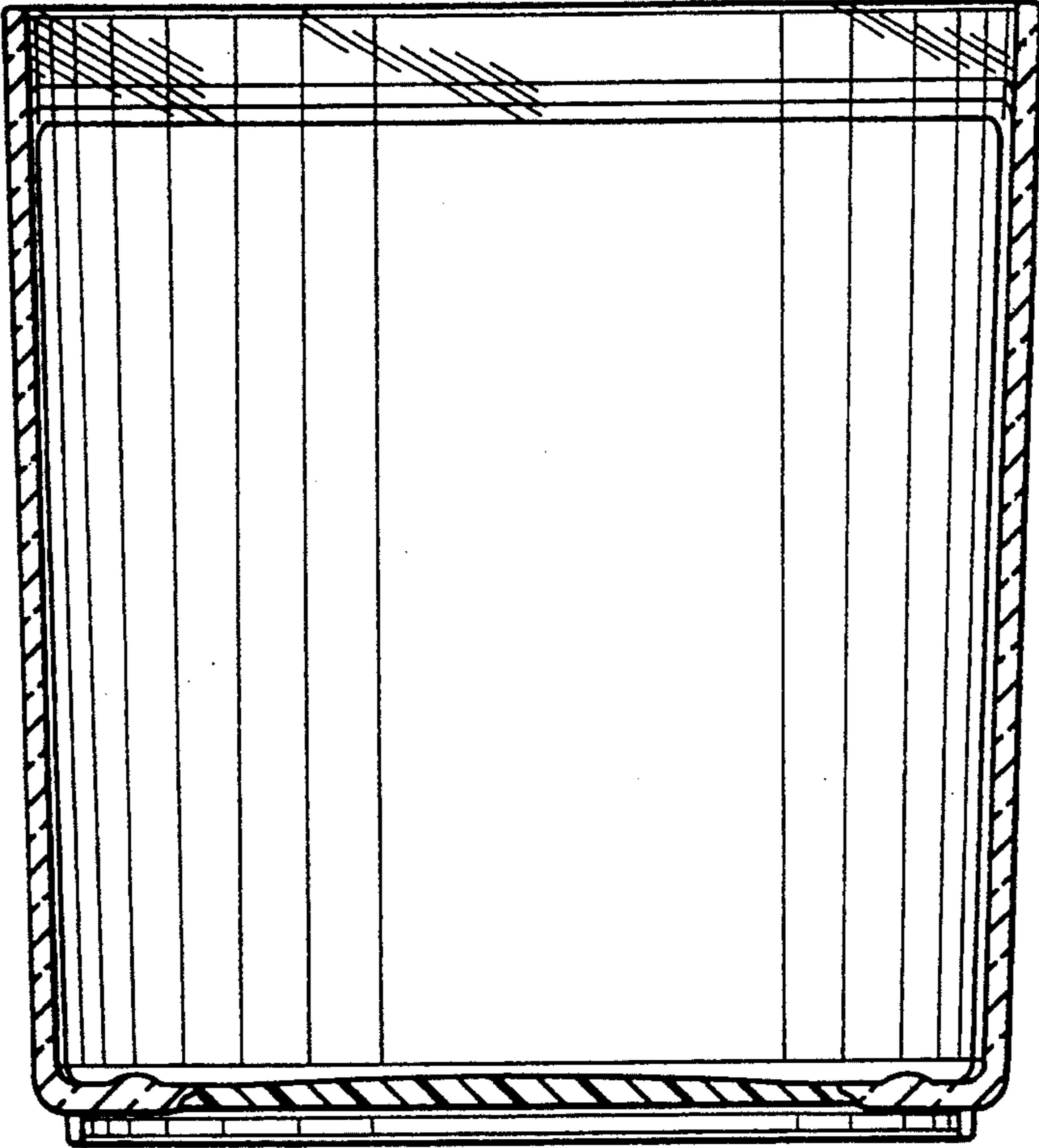

FIG. 6

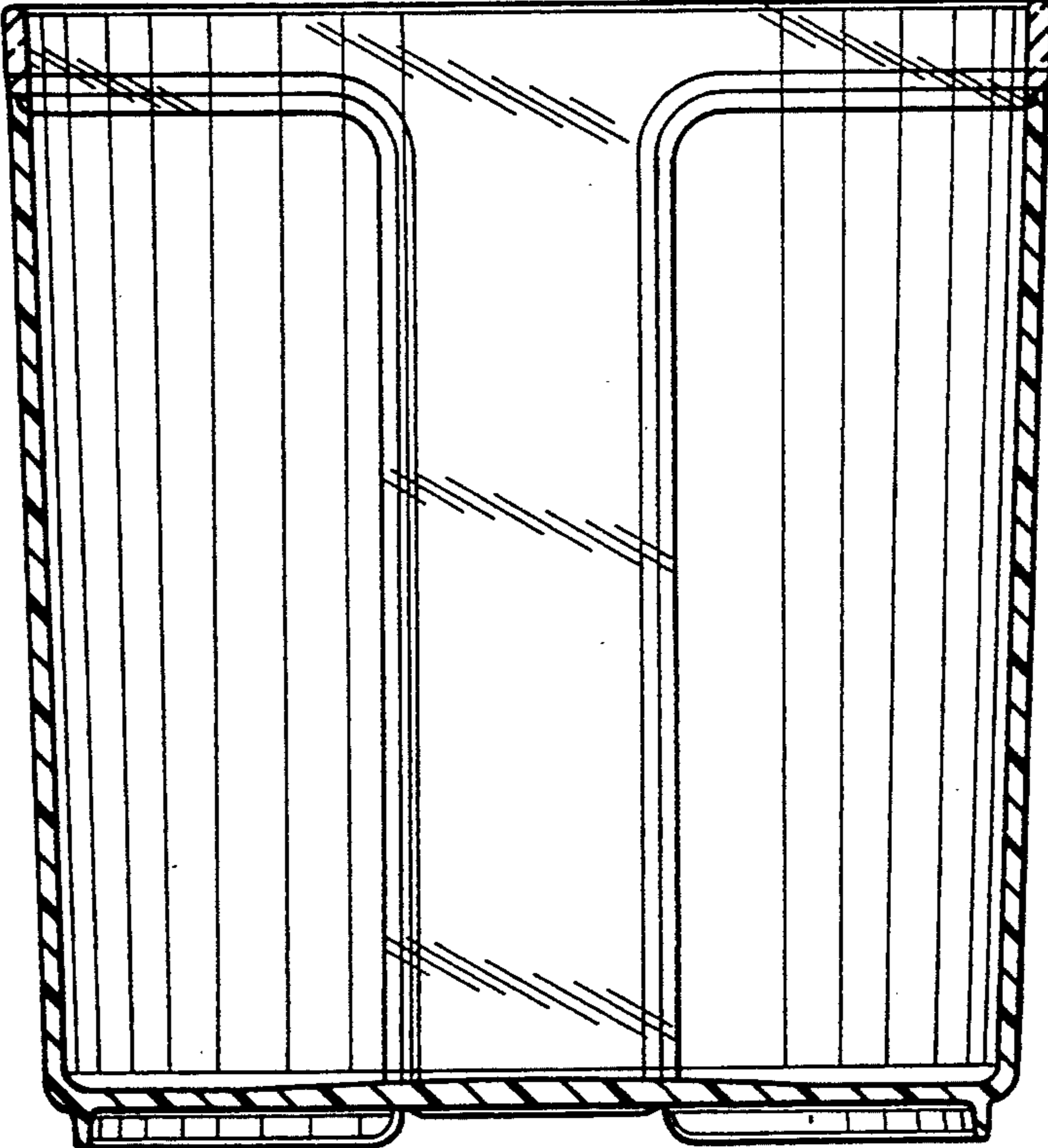

FIG. 7