



US00D352369S

# United States Patent [19]

[11] Patent Number: Des. 352,369

Figoni

[45] Date of Patent: \*\* Nov. 8, 1994

[54] SPLINT BOOT FOR FRONT RIGHT LEG OF A HORSE

[76] Inventor: Bonnie E. Figoni, 1955 Airport Blvd., Red Bluff, Calif. 96080

[\*\*] Term: 14 Years

[21] Appl. No.: 3,901

[22] Filed: Jan. 21, 1993

[52] U.S. Cl. .... D30/144

[58] Field of Search ..... 54/82, 79.1; 168/18; 602/23, 27, 65, 63; D30/144, 145, 146

### [56] References Cited

#### U.S. PATENT DOCUMENTS

581,042	4/1897	Sites	54/82
1,395,689	11/1921	McKenzie	54/82
1,945,226	1/1934	Lutsche	54/82
2,246,100	6/1941	Marzani	54/82
2,937,487	5/1960	Dever	54/82
3,193,984	7/1965	Schubert	54/82
3,405,506	10/1968	Kostur	54/82
3,913,302	10/1975	Centers	54/82
4,013,070	3/1977	Harroff	602/27
4,099,269	7/1978	Porner	54/82
4,342,185	8/1982	Pellew	54/82
4,470,411	9/1984	Hoyt, Jr.	54/82
4,869,267	9/1989	Grim et al.	602/65
4,911,150	3/1990	Farley	54/82
4,974,398	12/1990	Kaski	54/82
5,115,627	5/1992	Scott	54/82
5,152,285	10/1992	Gnegy	54/82

#### FOREIGN PATENT DOCUMENTS

2404428	6/1979	France	54/82
3715015	12/1988	Germany	54/82
9197	of 1907	United Kingdom	54/82
2164538	3/1986	United Kingdom	54/82
2241632	9/1991	United Kingdom	54/82
01183	3/1985	WIPO	54/82
1911	3/1990	WIPO	602/27
2018072	10/1992	WIPO	602/23

#### OTHER PUBLICATIONS

The Miller Publishing Co. Tack 'n Togs book; 1992-1993; 22nd Annual Buyers Guide Issue; vol. 23; No. 6B; p. 17-item #94; p. 43-item horse boot right,

bottom corner pg.; p. 127-Horse boot-top pg.; p. 28--Wade boots; p. 191-Lende Horse Shipping boot.

Bar-F Products, Inc.; Quality Horse Products Catalog 1991-1992, Horse Boots p. 2-#506; p. 5-#525 & 59; p. 7-#300.

Primary Examiner—Cathy Anne MacCormac  
Attorney, Agent, or Firm—Bernhard Kreten

### [57] CLAIM

The ornamental design for a split boot for front right leg of a horse, as shown and described.

### DESCRIPTION

FIG. 1 is an outside perspective view of a boot for horses for the right leg showing my new design;

FIG. 2 is an inside perspective view of an alternate embodiment for the left leg which is a mirror image of the embodiment of FIG. 1;

FIG. 3 is an inside perspective view of the right boot;

FIG. 4 is an outside perspective view of the alternate embodiment;

FIG. 5 is rear elevational view of the right boot;

FIG. 6 is a right side elevational view of the right boot;

FIG. 7 is a front elevational view of the right boot;

FIG. 8 is an inside elevational view of the right boot;

FIG. 9 is a rear elevational view of the alternate embodiment;

FIG. 10 is an outside elevational view of the alternate embodiment;

FIG. 11 is a front elevational view of the alternate embodiment;

FIG. 12 is an inside elevational view of the alternate embodiment;

FIG. 13 is a outside perspective view of the alternate embodiment showing the boot in open position;

FIG. 14 is an outside perspective view of the right boot shown in open position;

FIG. 15 is an inside perspective view of the right boot shown in open position;

FIG. 16 is an inside perspective view of the alternate embodiment showing the boot in open position;

FIG. 17 is a side elevational view of the right boot shown in open position;

(Description continued on next page.)

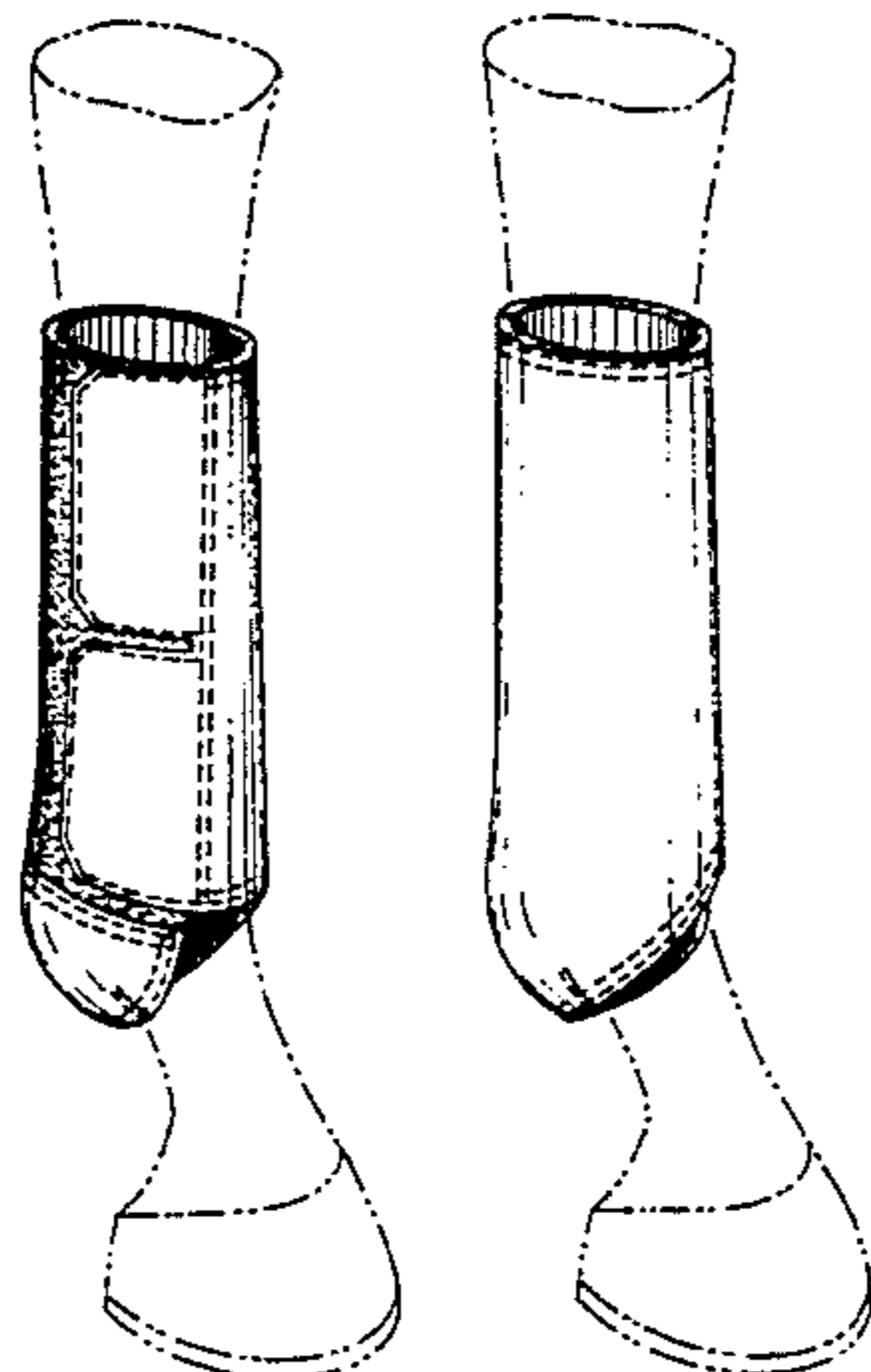

FIG. 18 is a rear elevational view of the right boot shown in open position;

FIG. 19 is a side elevational view of the opposite side of FIG. 17 showing the boot in open position;

FIG. 20 is a front elevational view of the right boot shown in open position;

FIG. 21 is a side elevational view of the alternate embodiment showing the boot in open position;

FIG. 22 is a rear elevational view of the alternate embodiment shown in open position;

FIG. 23 is a side elevational view of the opposite side of FIG. 21 showing the boot in open position;

FIG. 24 is front elevational view of the alternate embodiment showing the boot in open position;

FIG. 25 is a top plan view of the right boot;

FIG. 26 is a top plan view of the right boot shown in open position;

FIG. 27 is a top plan view of the alternate embodiment;

FIG. 28 is a top plan view of the alternate embodiment showing the boot in open position;

FIG. 29 is a bottom plan view of the right boot;

FIG. 30 is a bottom plan view of the right boot shown in open position;

FIG. 31 is a bottom plan view of the alternate embodiment; and,

FIG. 32 is a bottom plan view of the alternate embodiment showing the boot in open position.

The broken lines in FIGS. 1-4 are for purposes of illustration only and form no part of the claimed design. The dashed and zig-zagged lines in all views represent stitching.

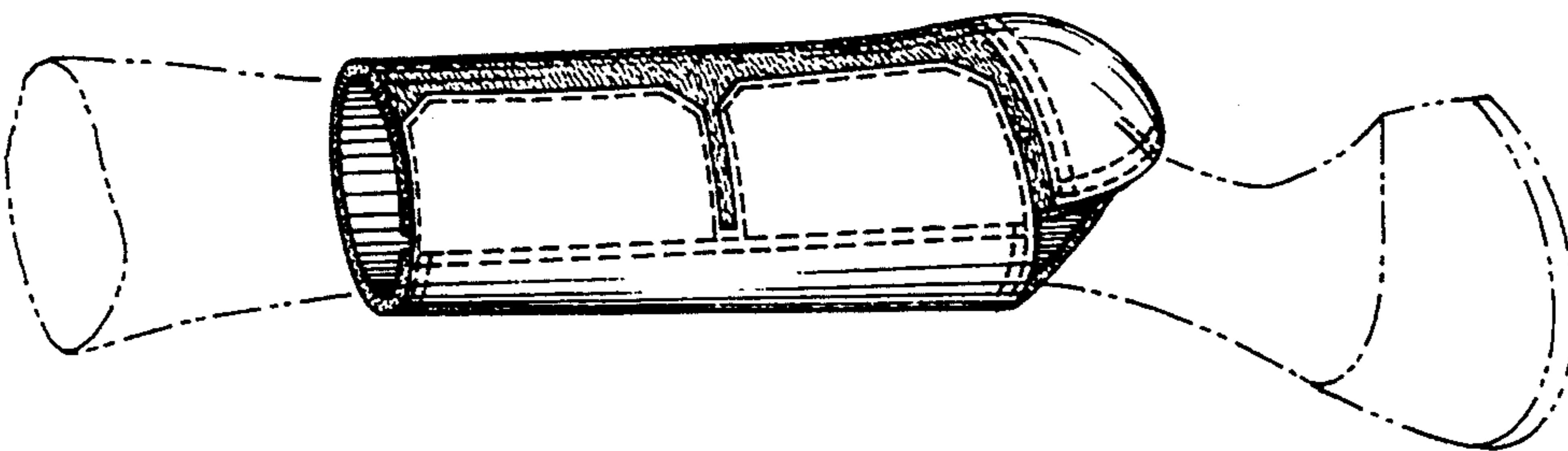

Figure 4

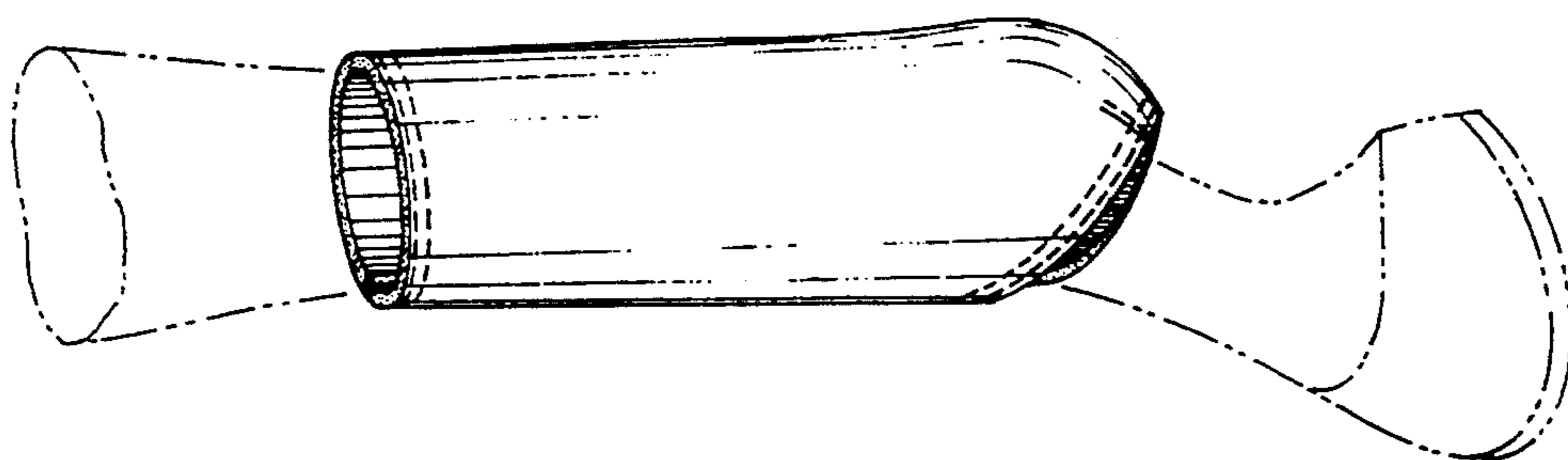

Figure 3

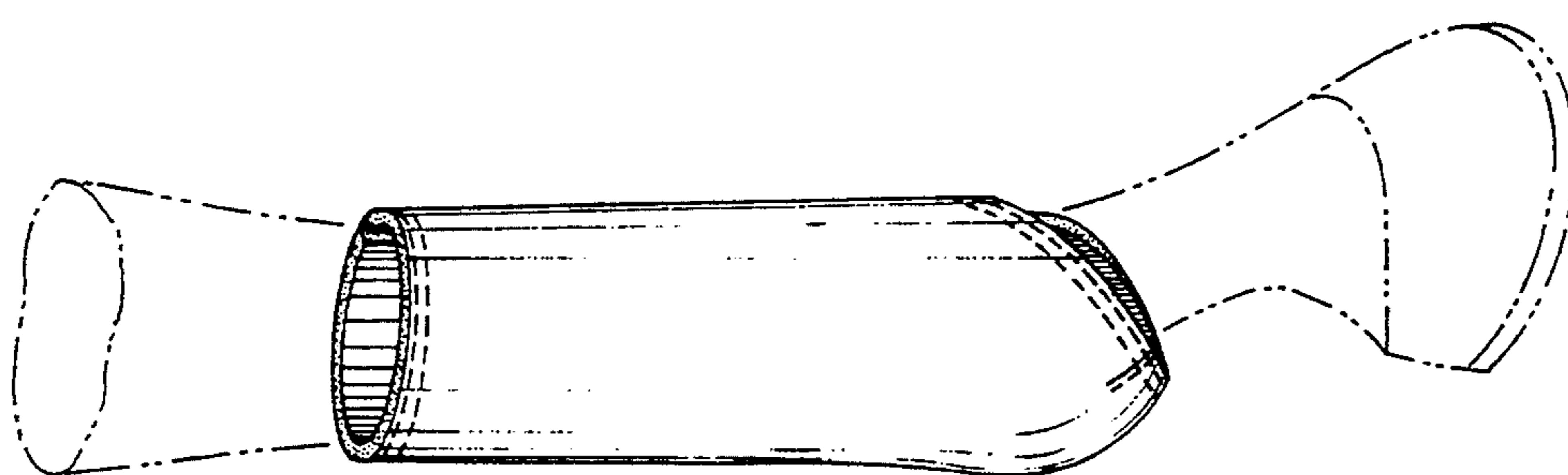

Figure 2

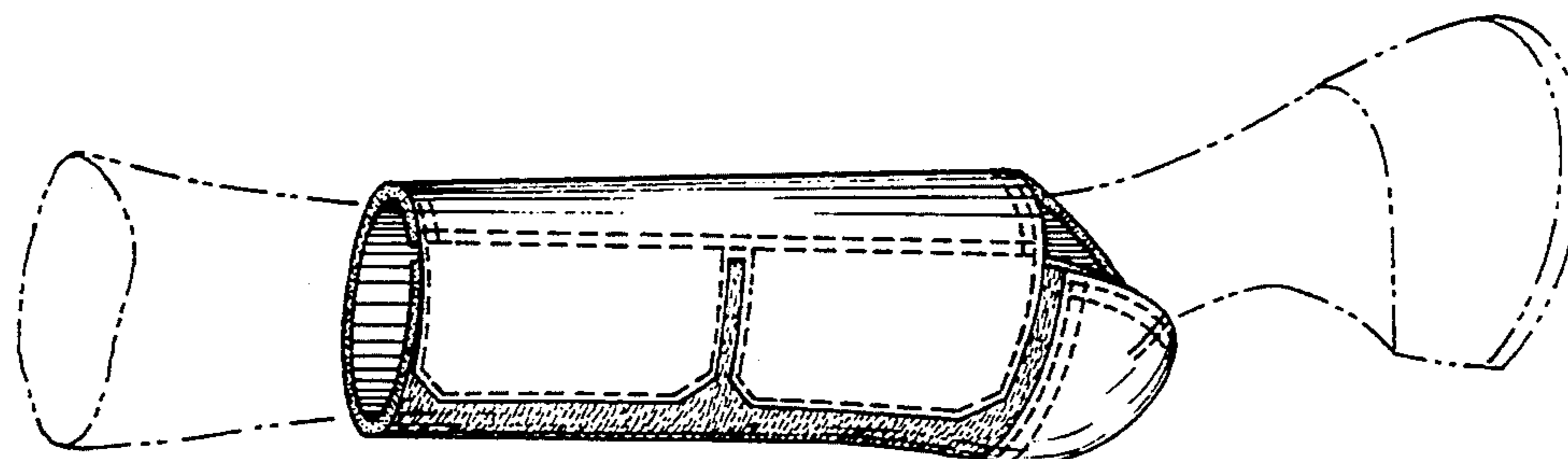

Figure 1

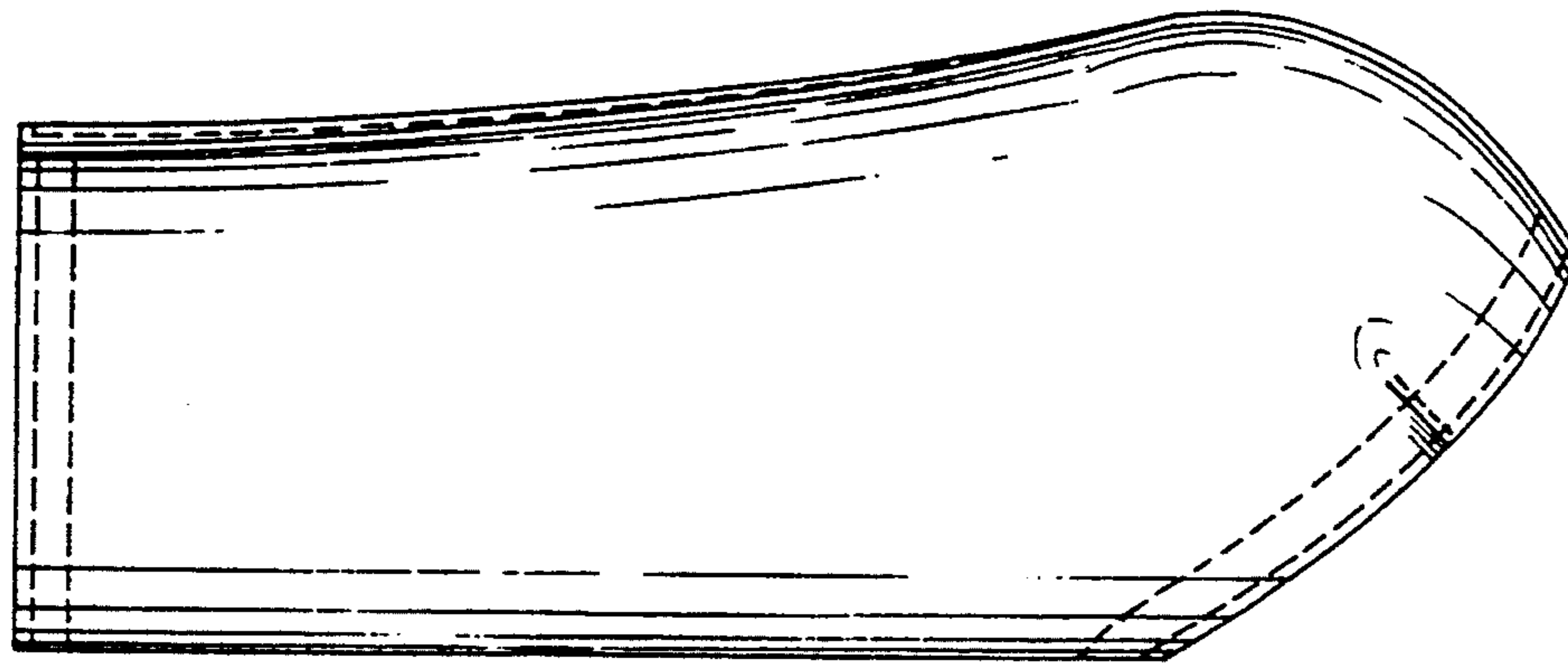

Figure 8

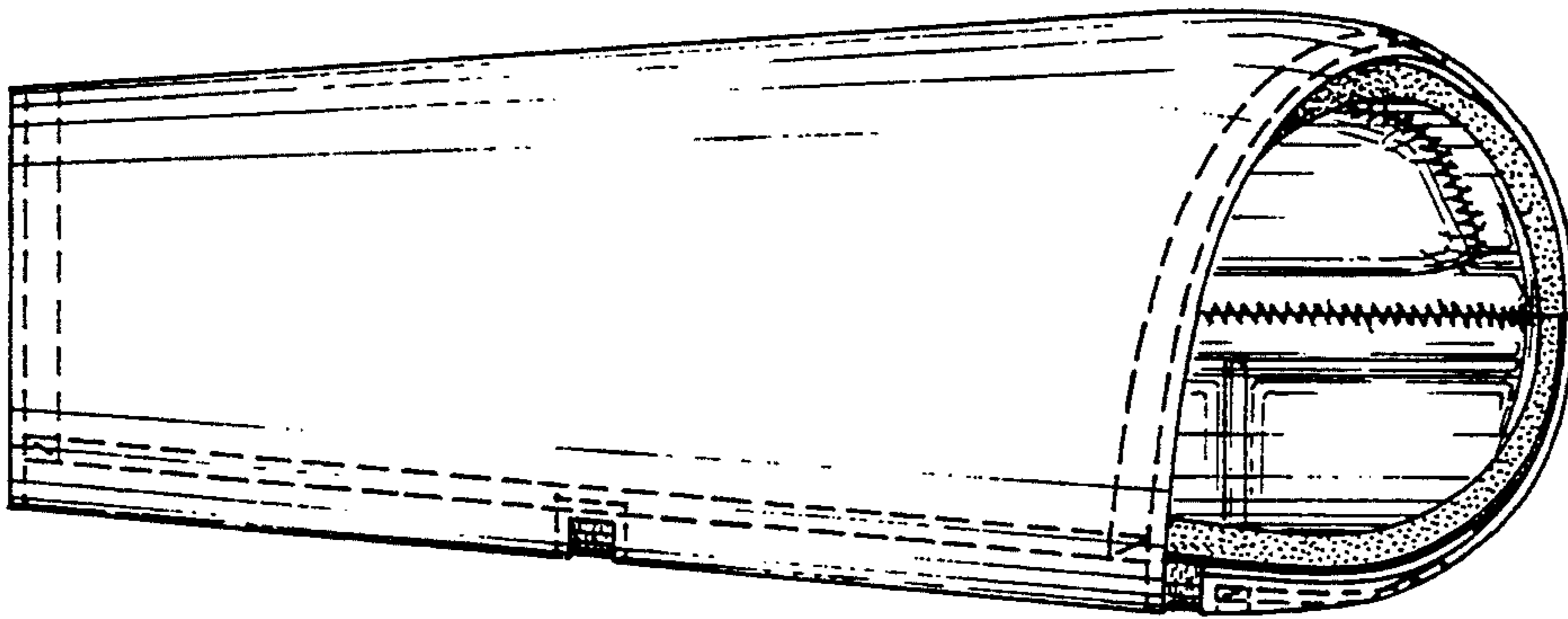

Figure 7

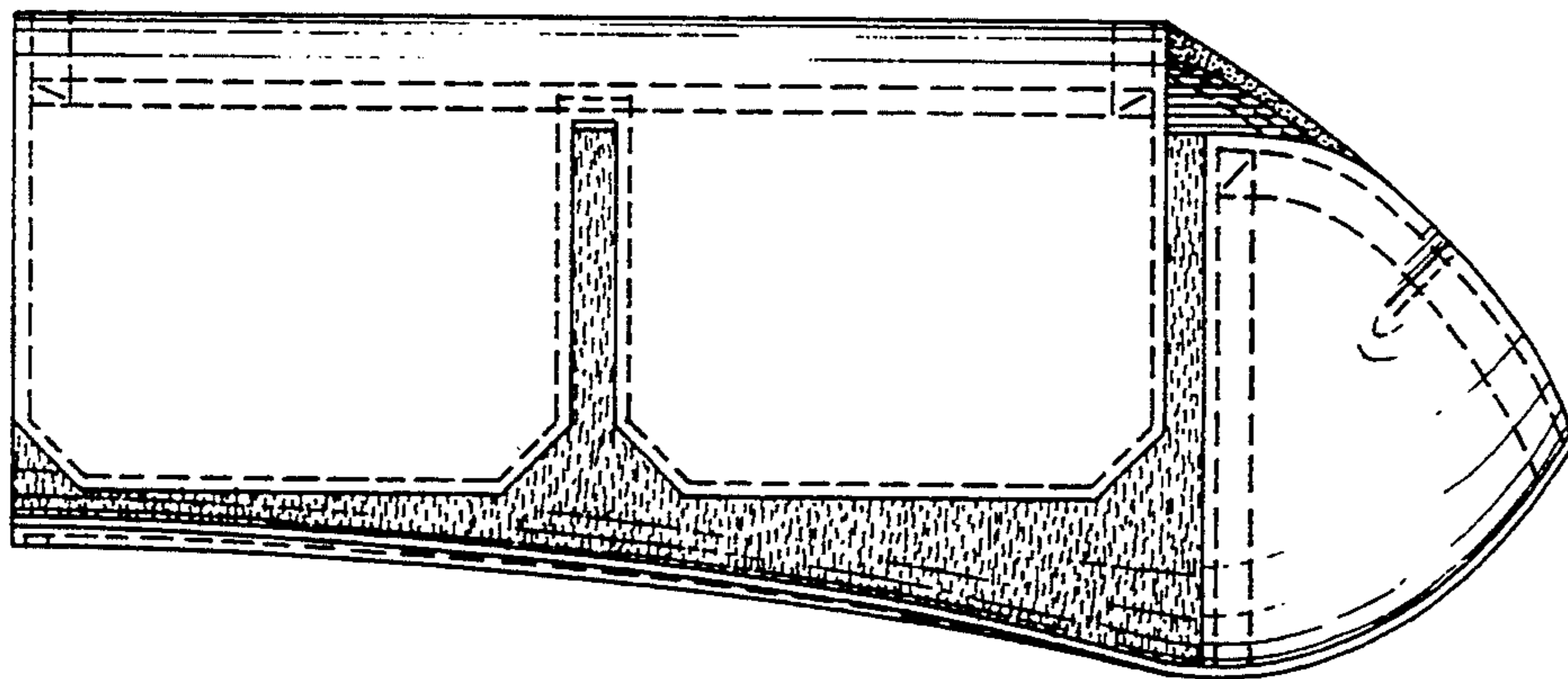

Figure 6

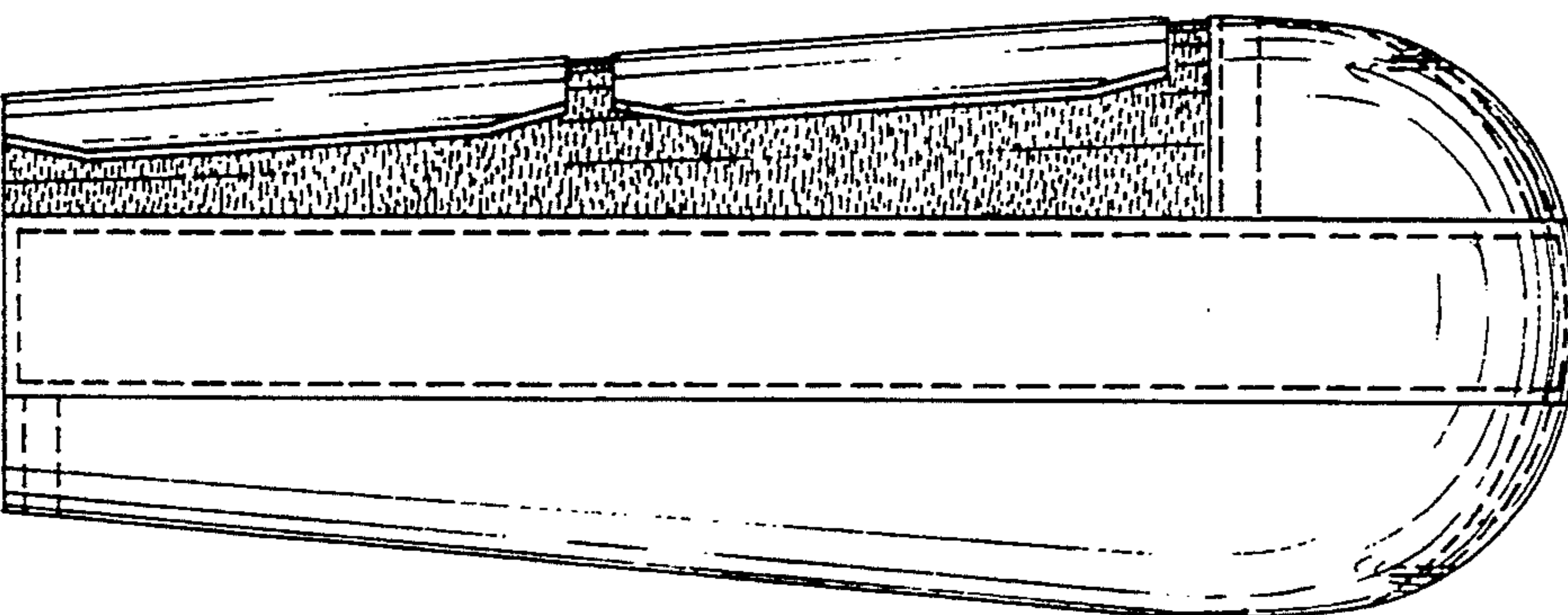

Figure 5

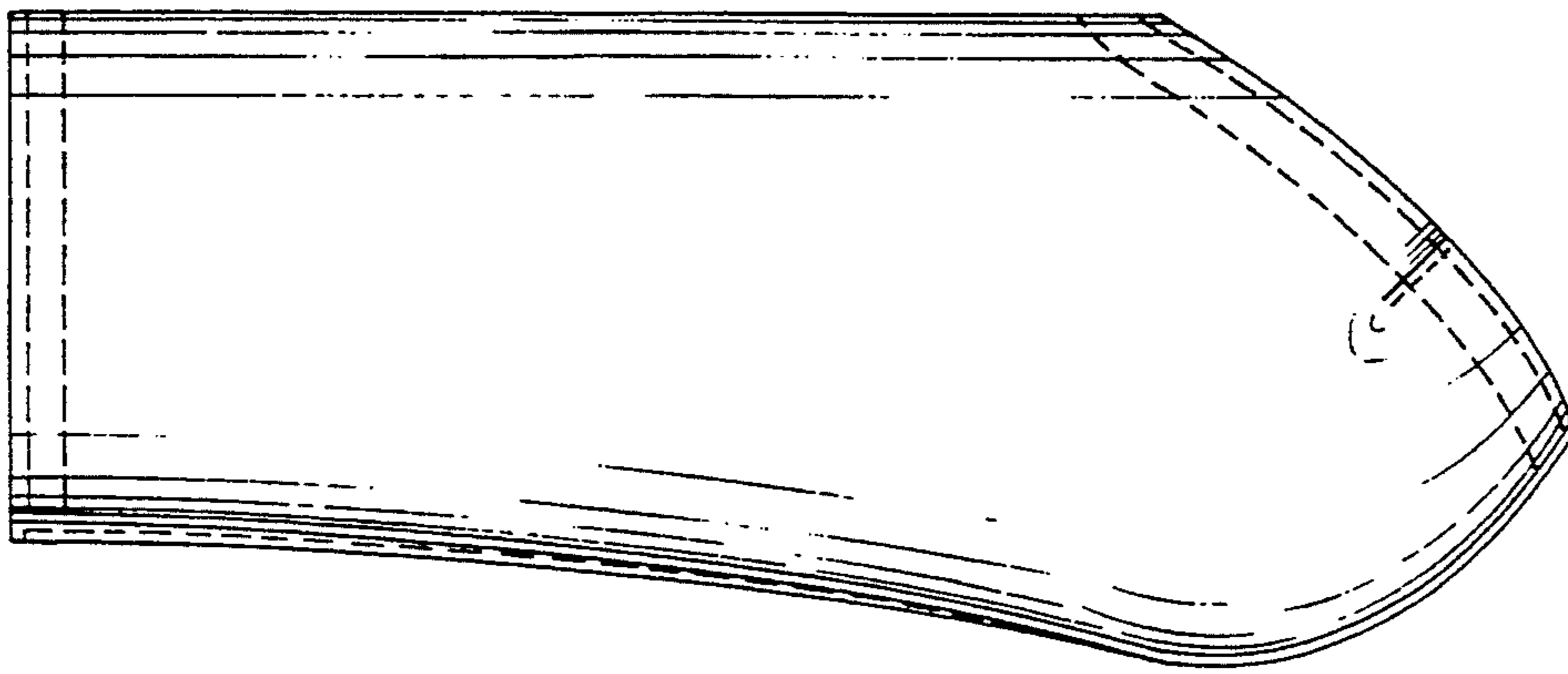

Figure 12

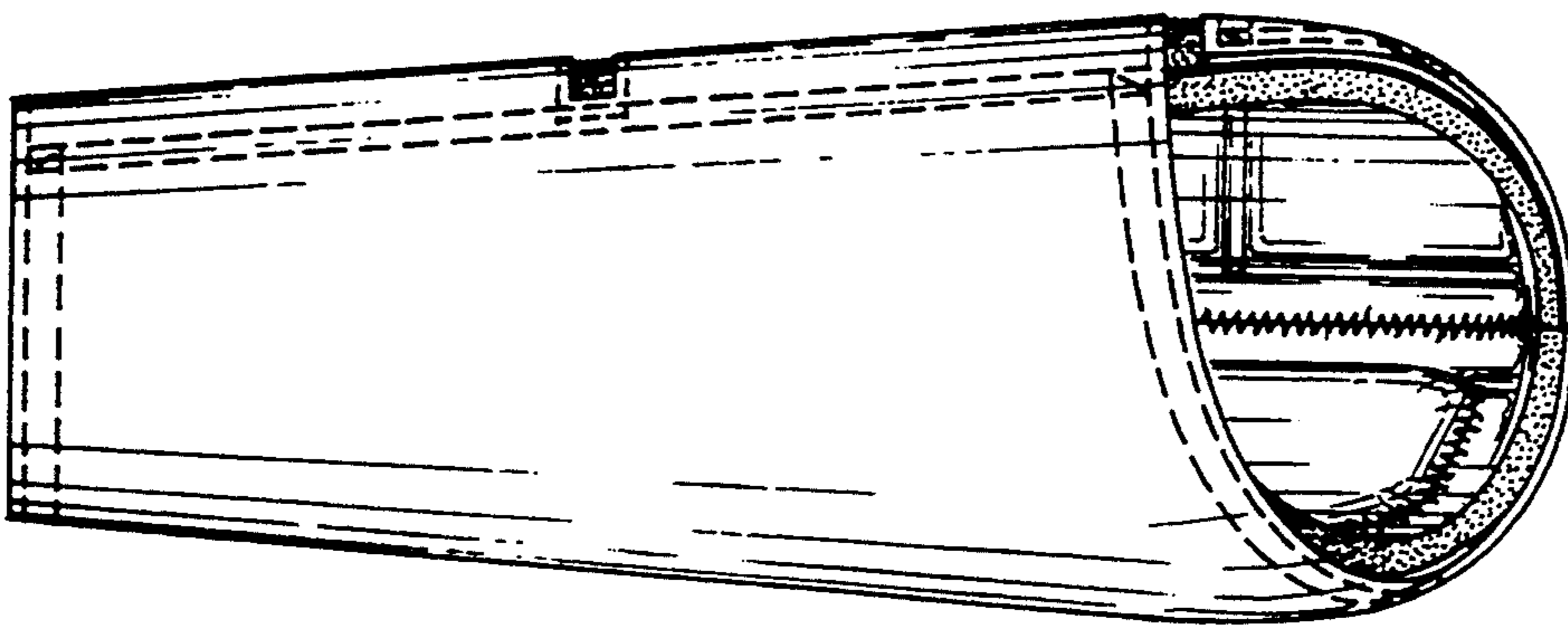

Figure 11

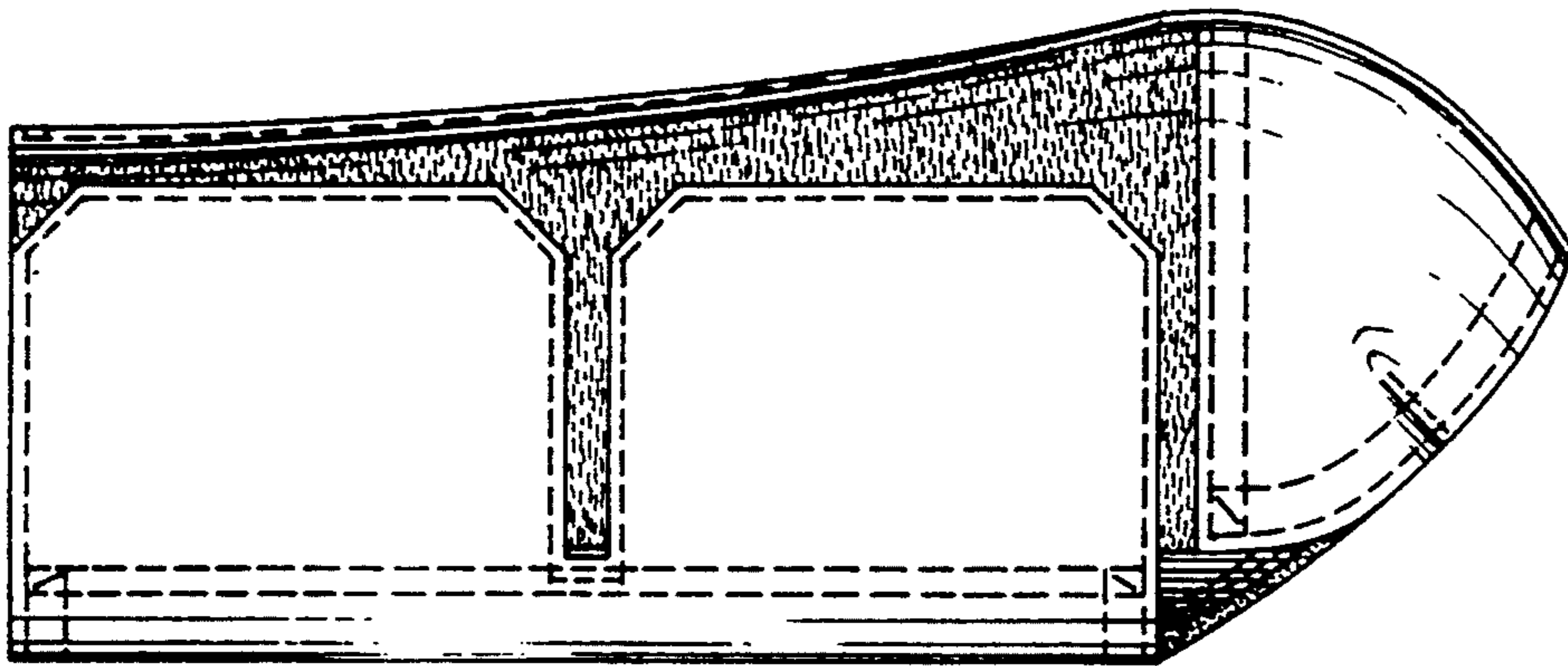

Figure 10

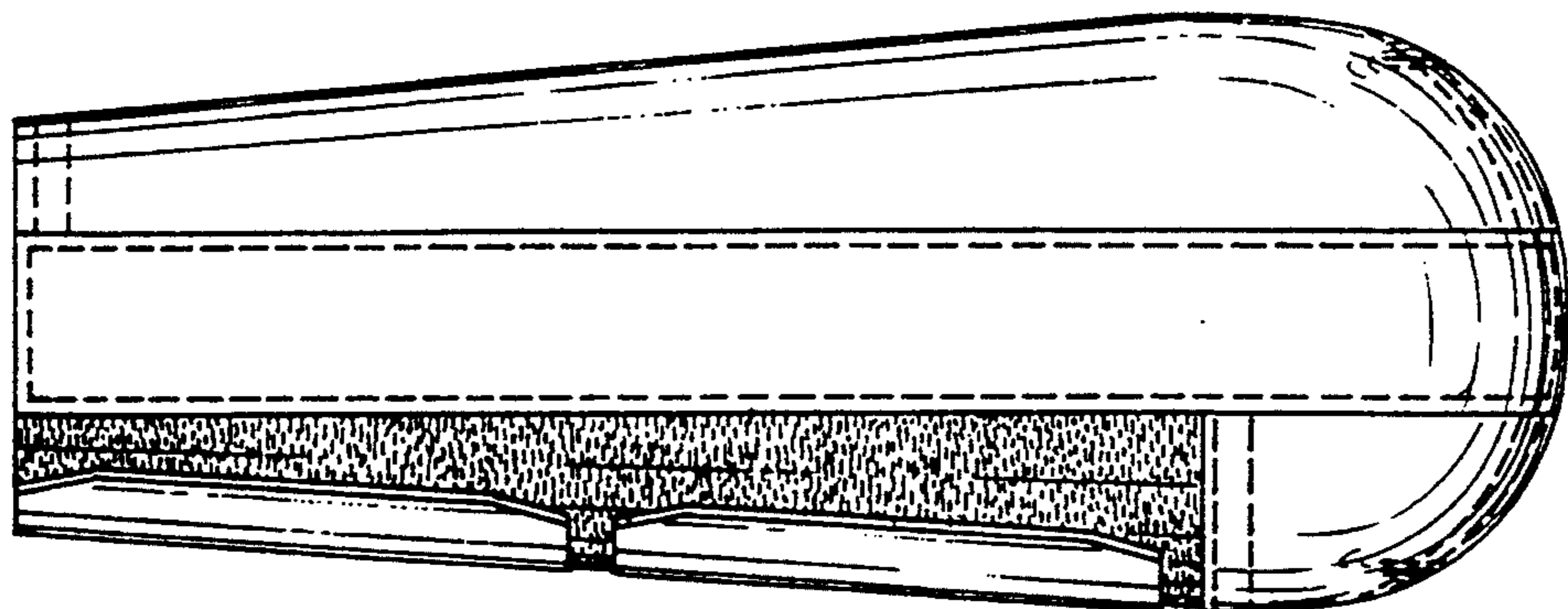

Figure 9

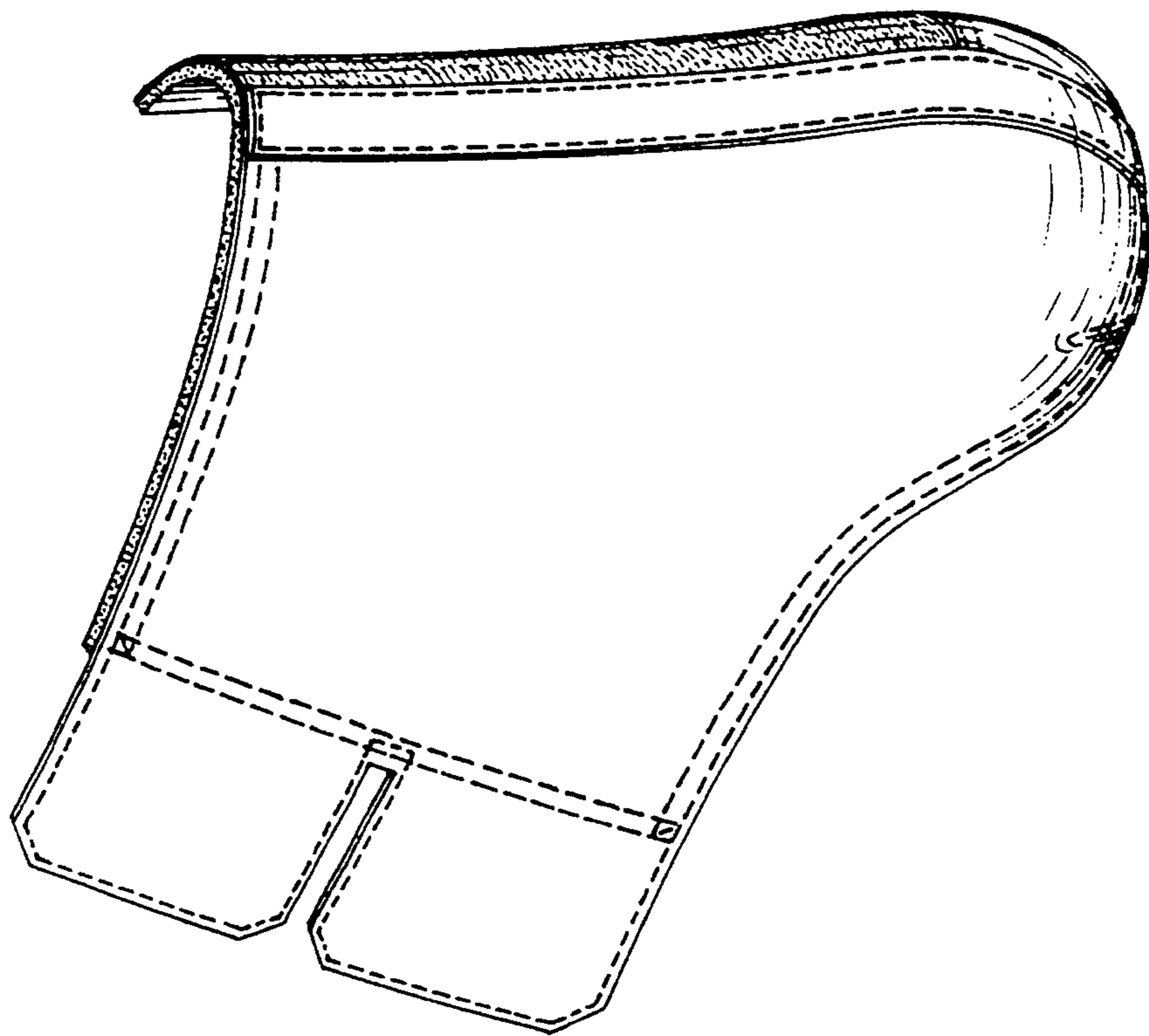

Figure 14

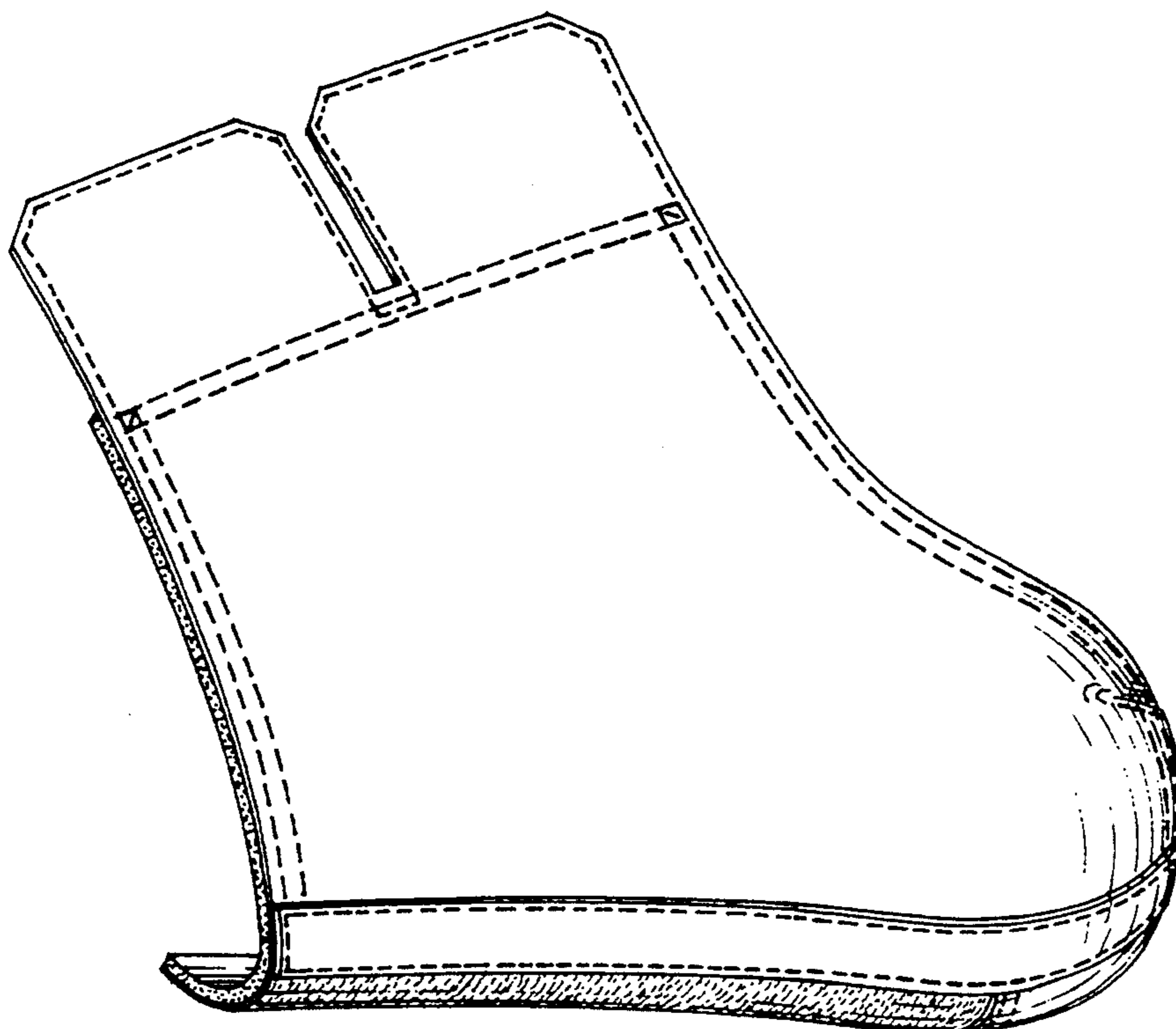

Figure 13

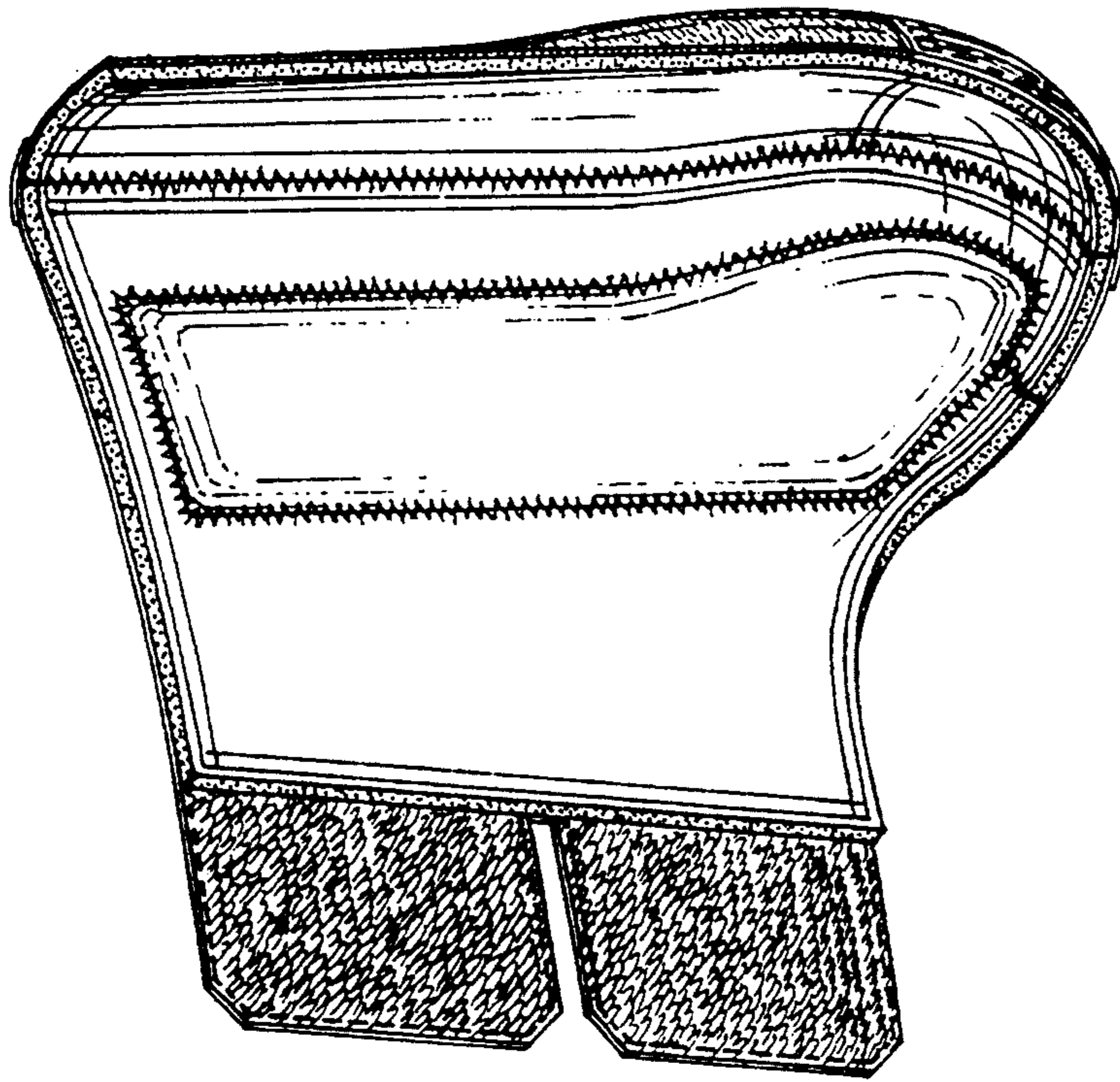

Figure 16

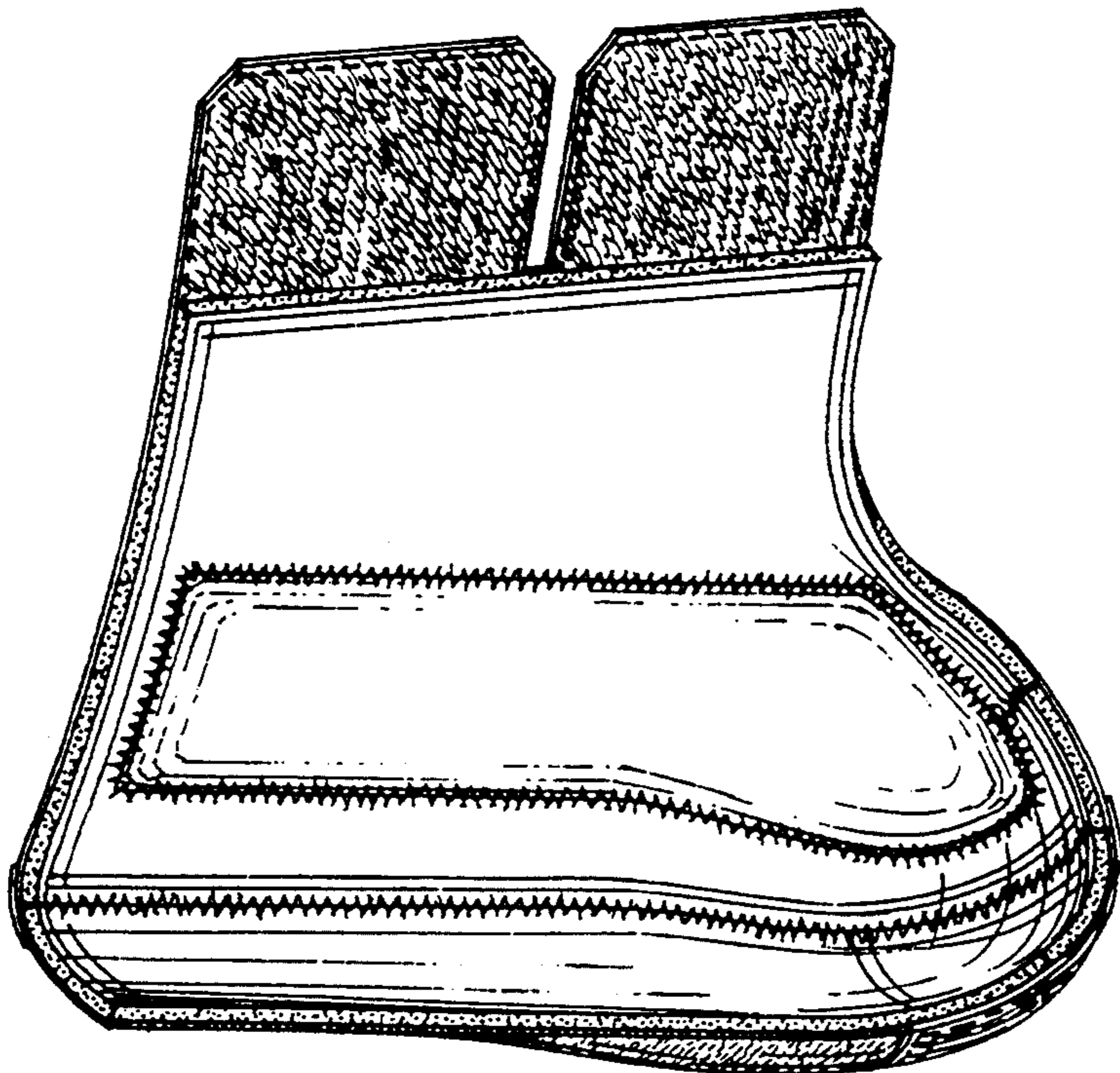

Figure 15

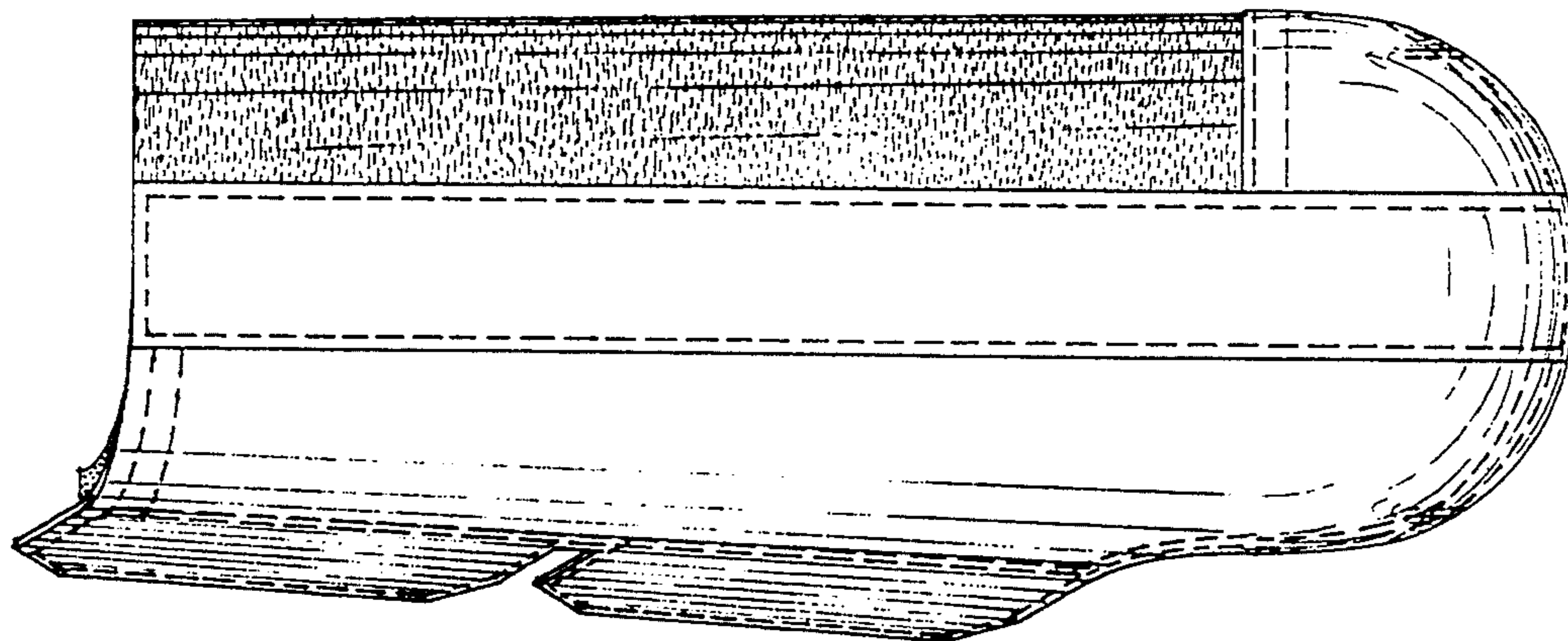

Figure 18

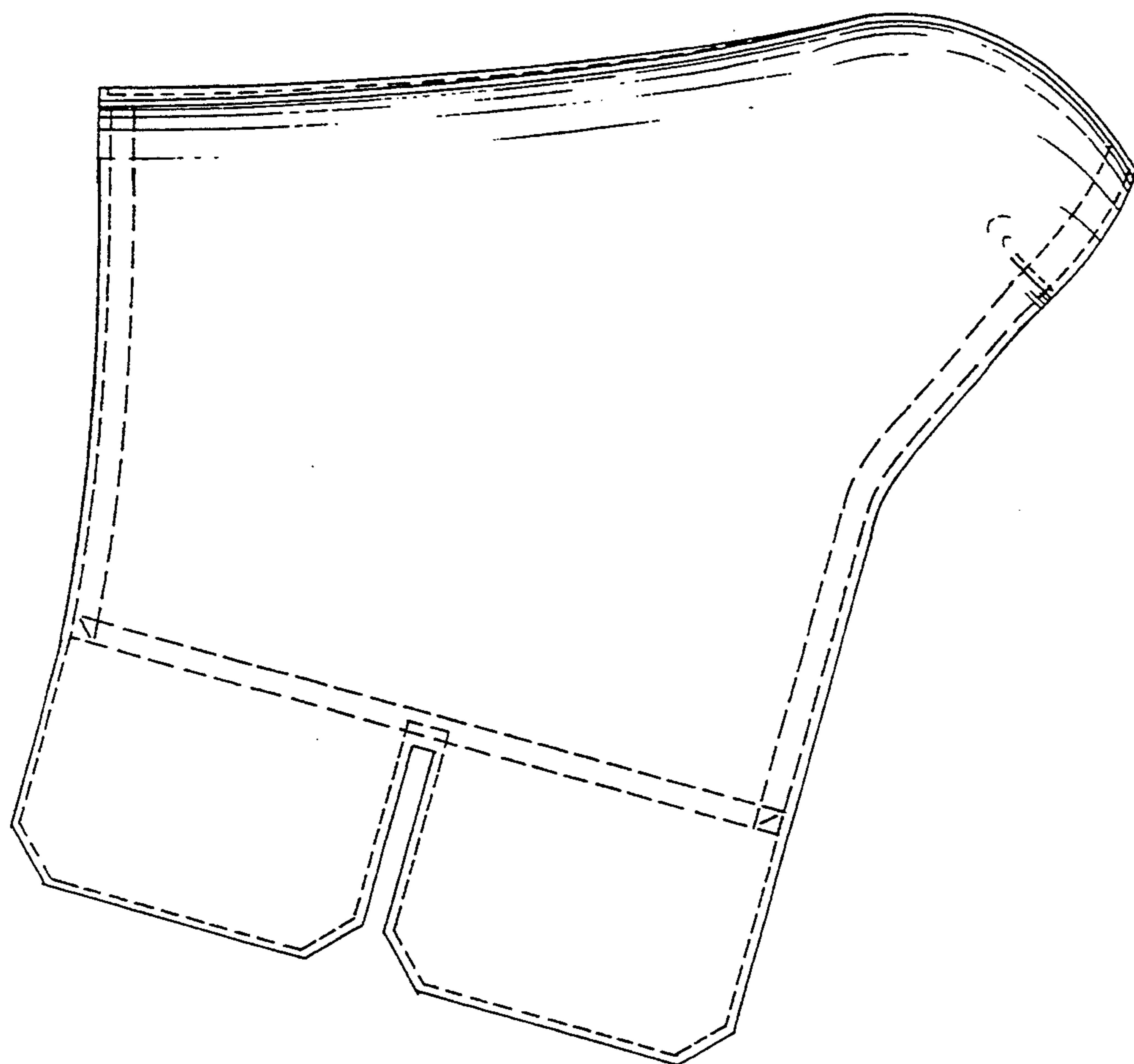

Figure 17



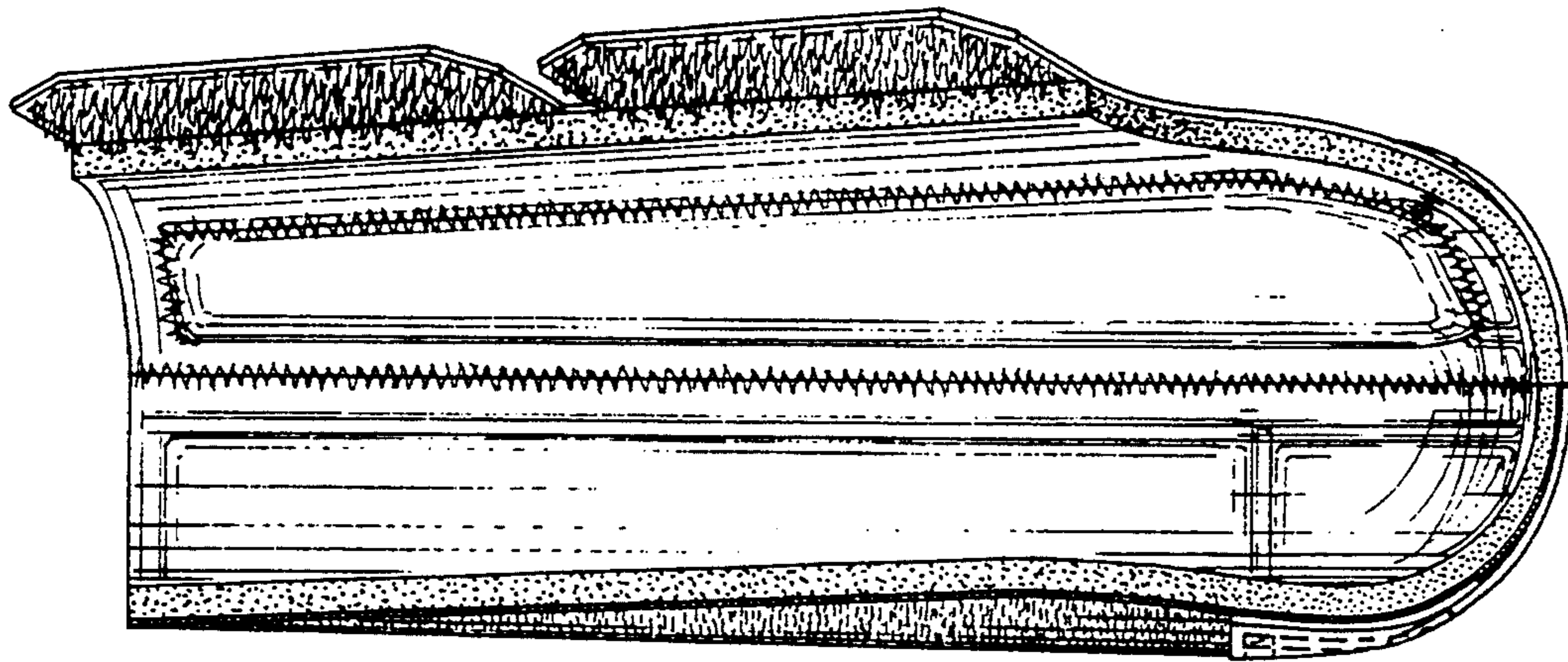

Figure 20

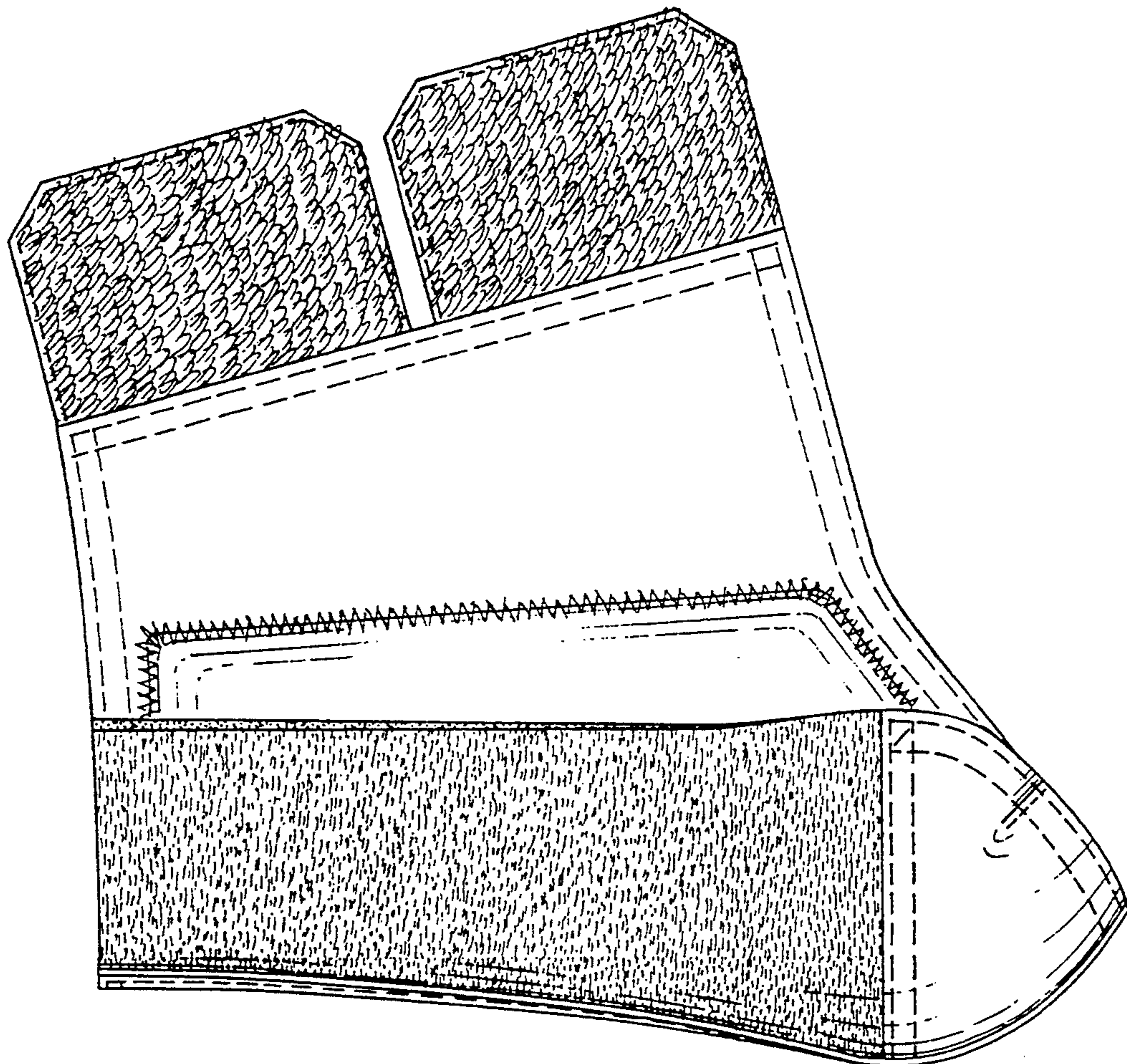

Figure 19

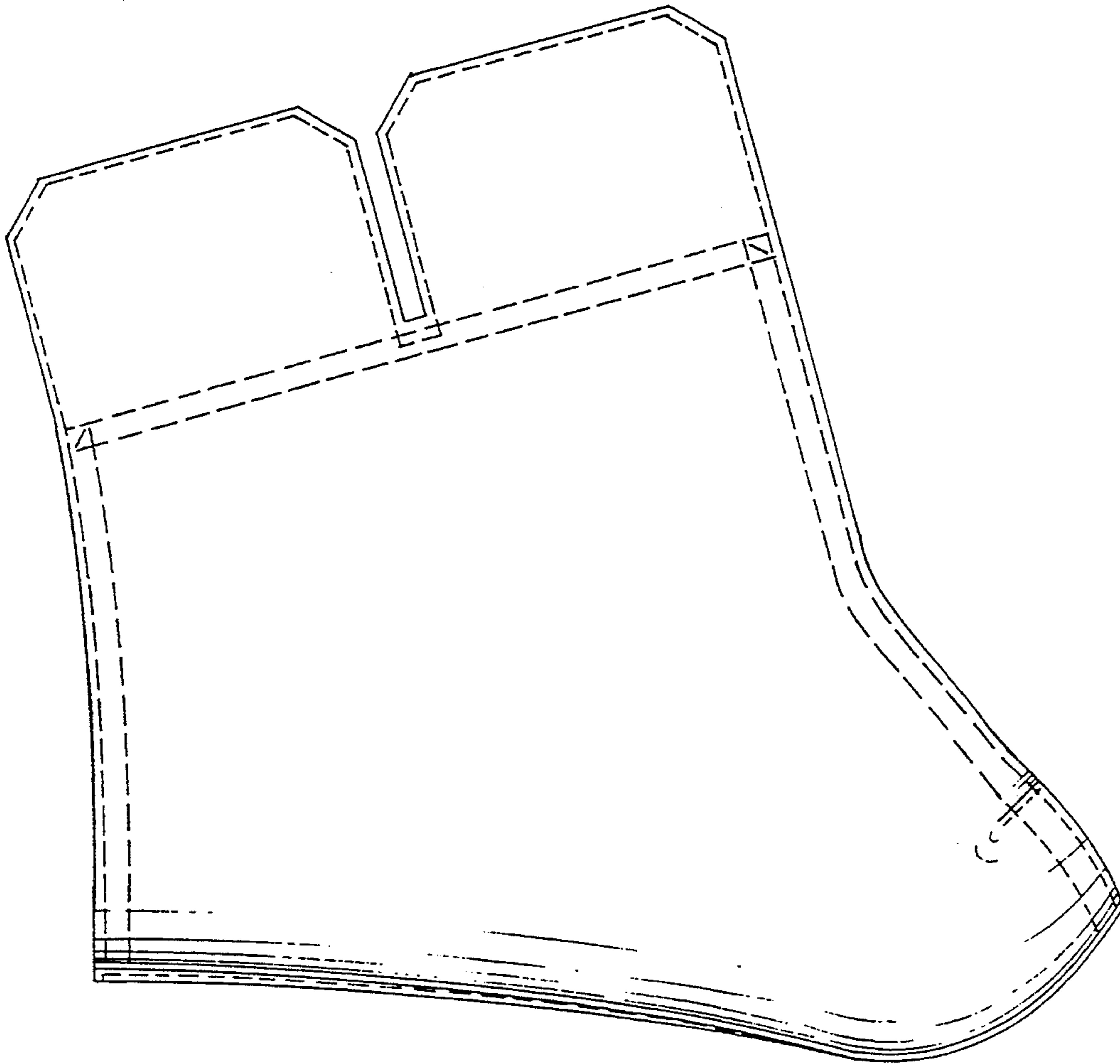

Figure 22

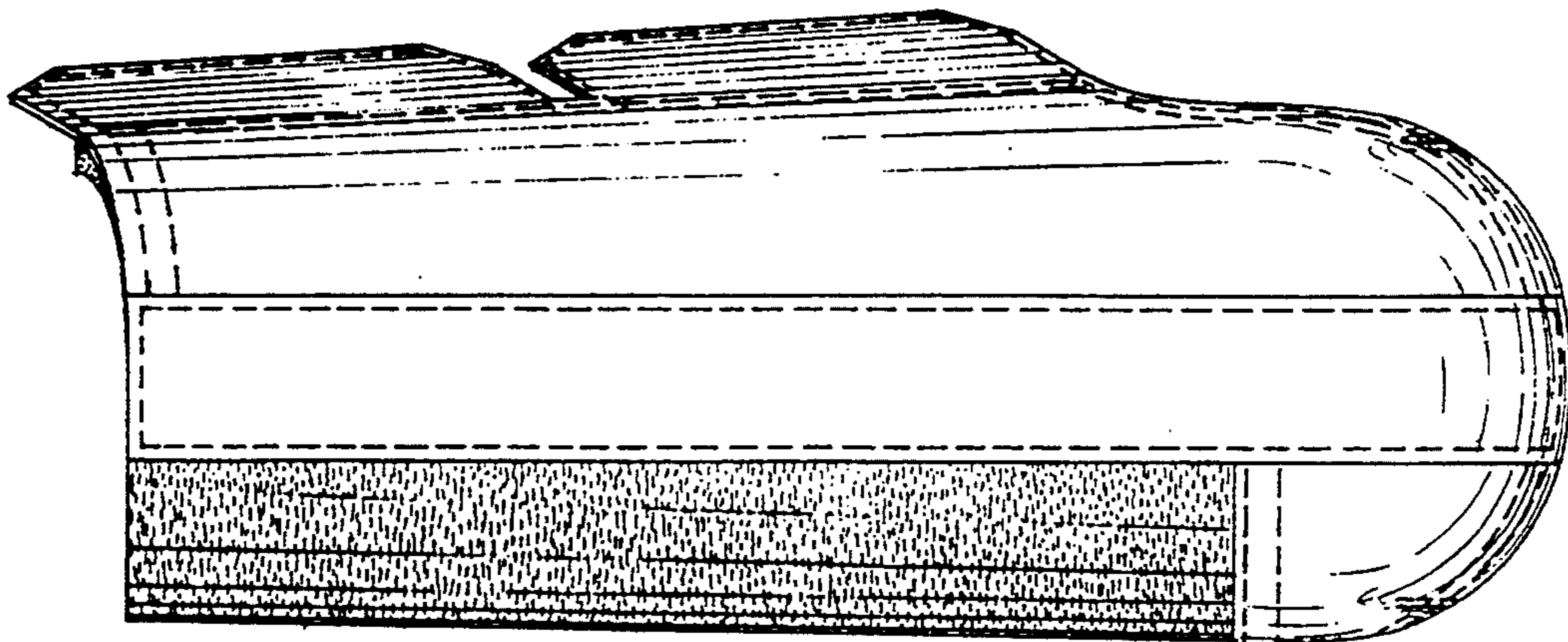

Figure 21

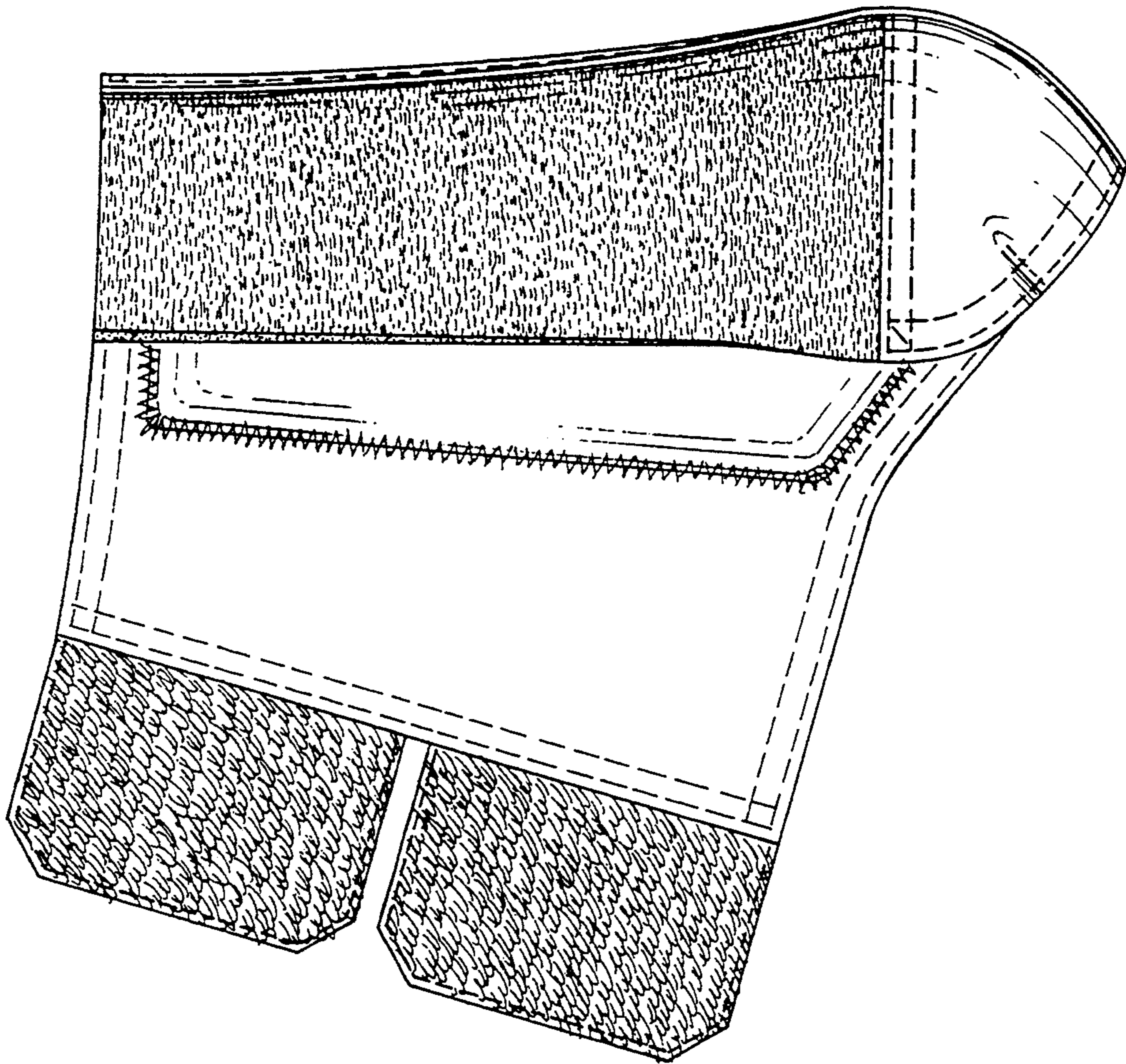

Figure 24

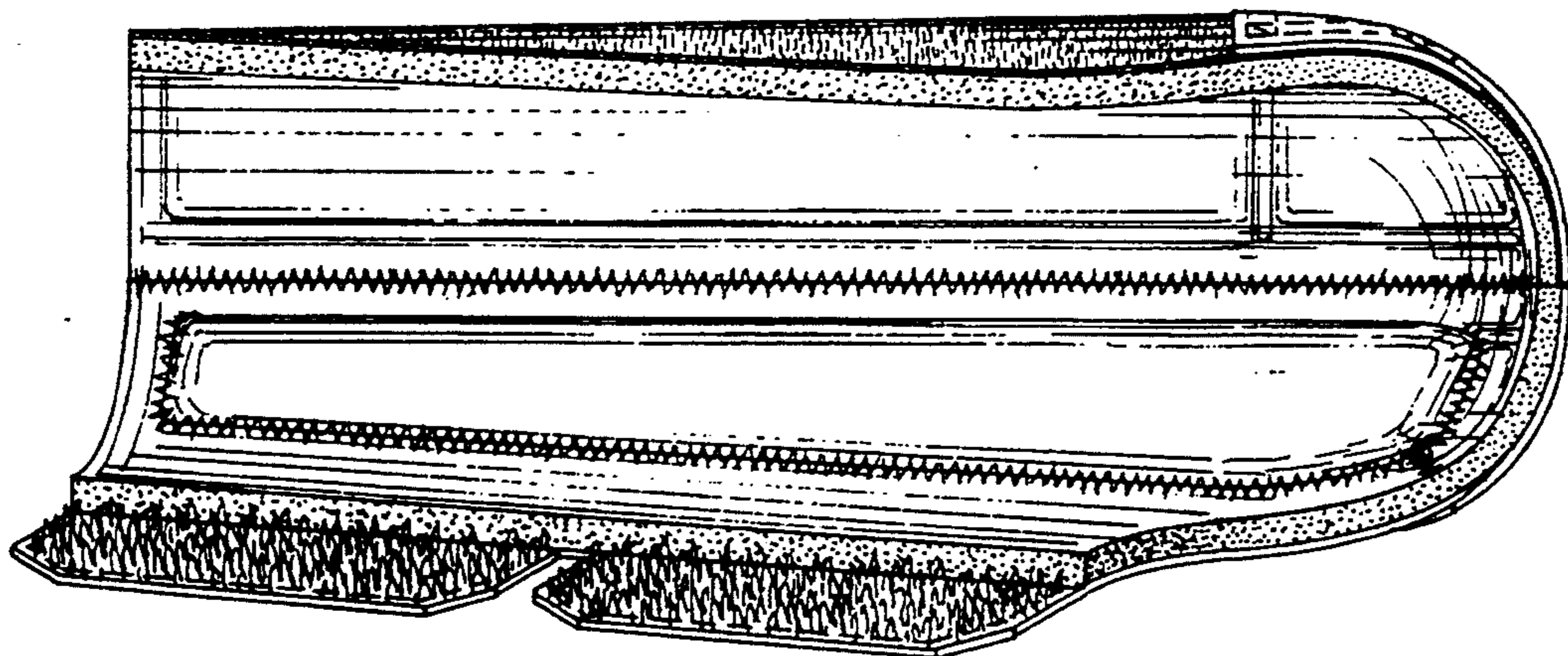

Figure 23

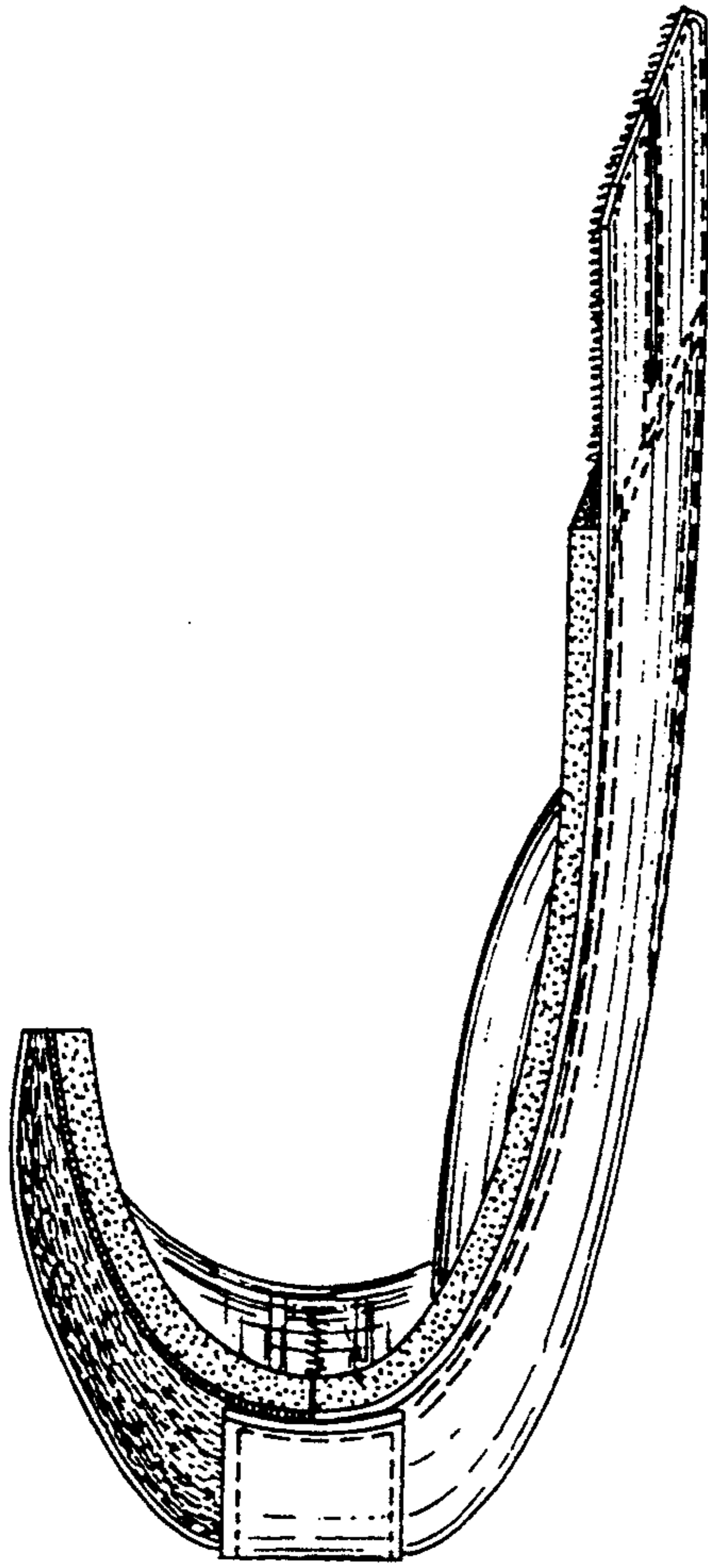

Figure 28

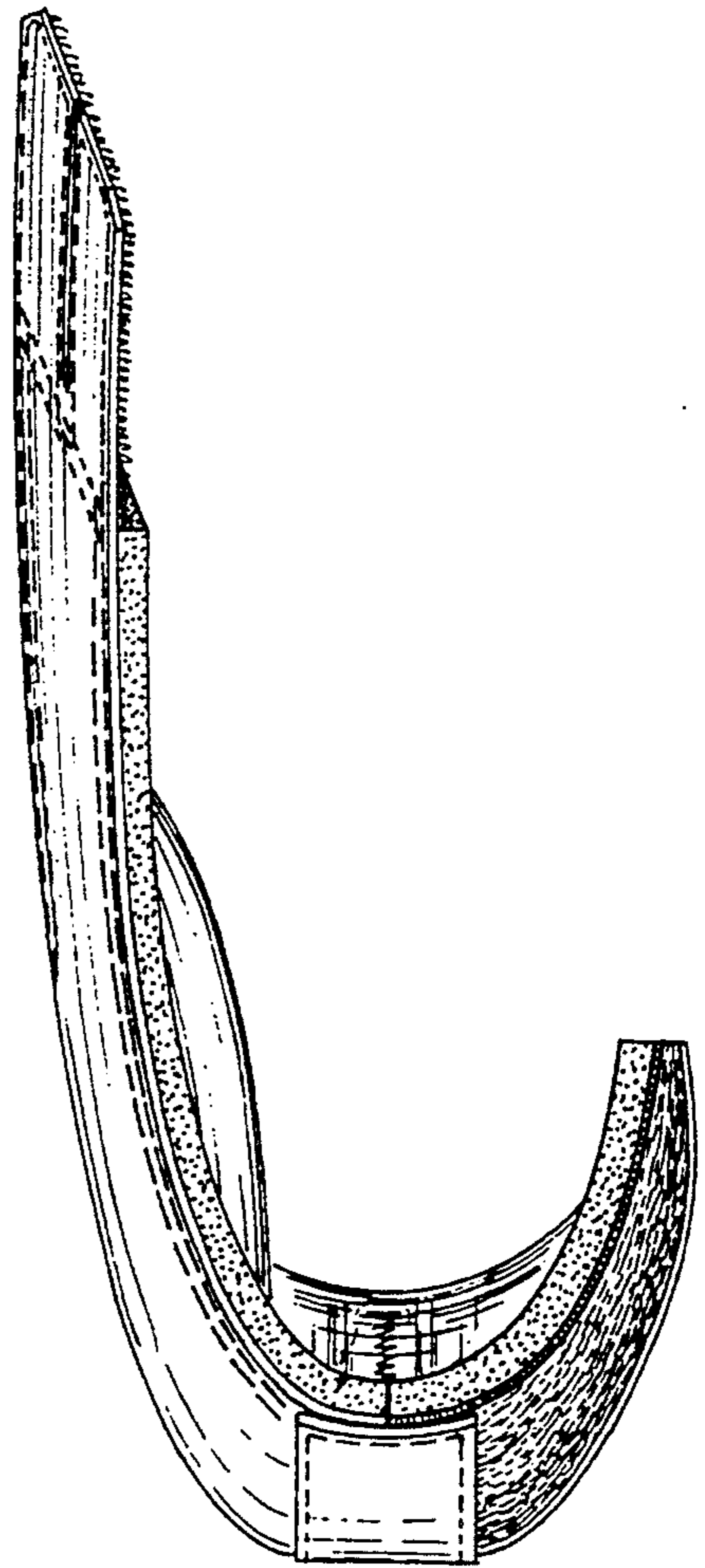

Figure 26

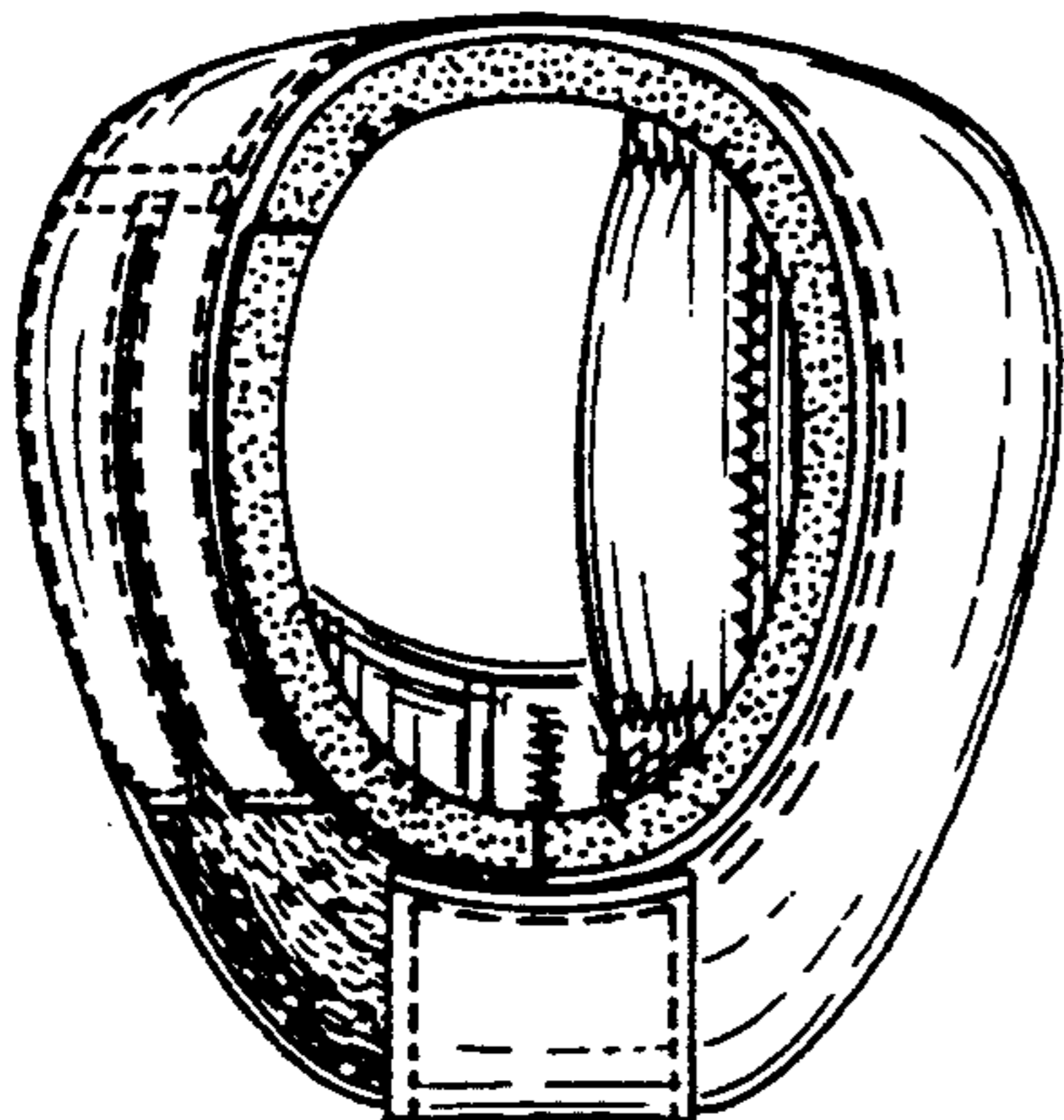

Figure 27

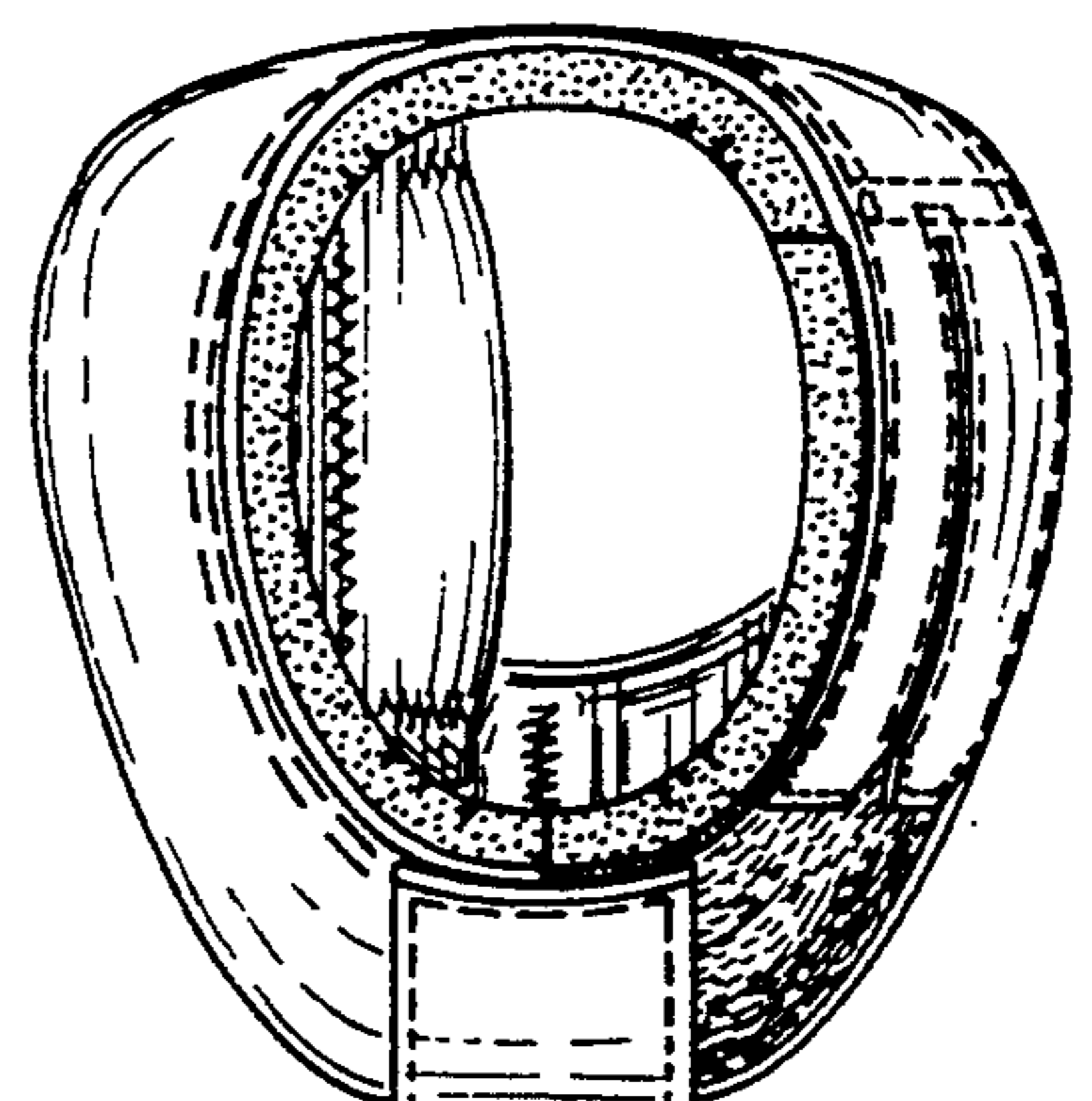

Figure 25

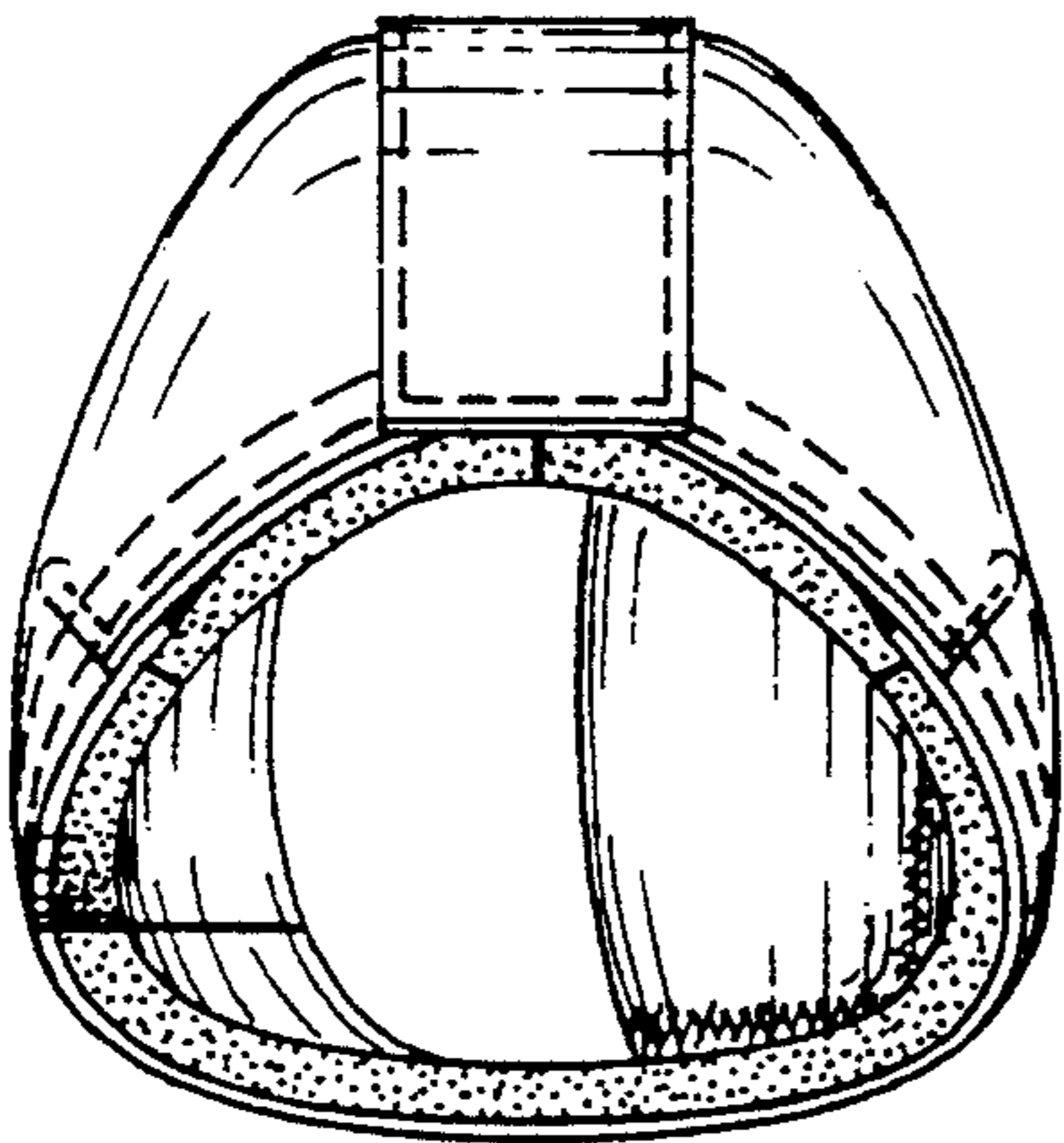

Figure 31

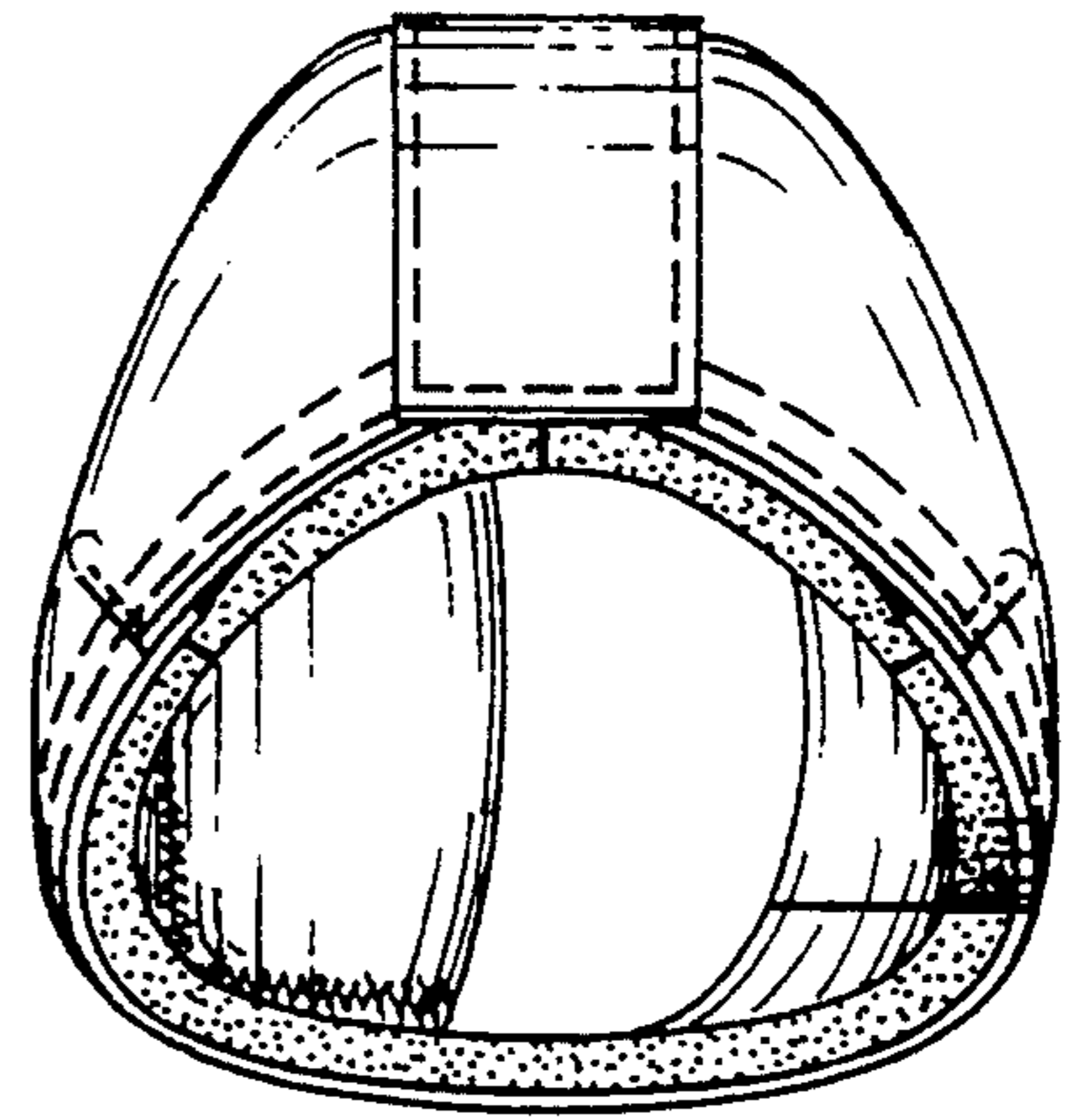

Figure 29

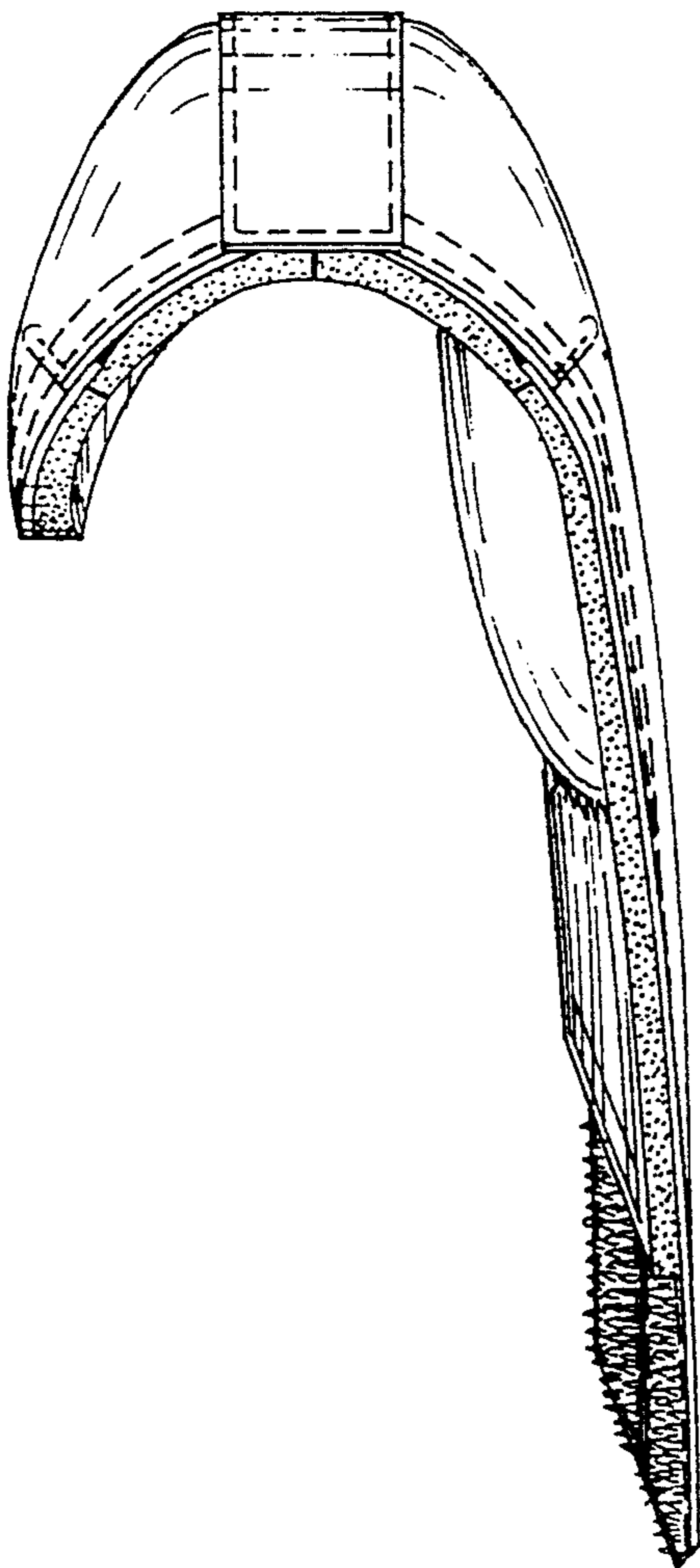

Figure 32

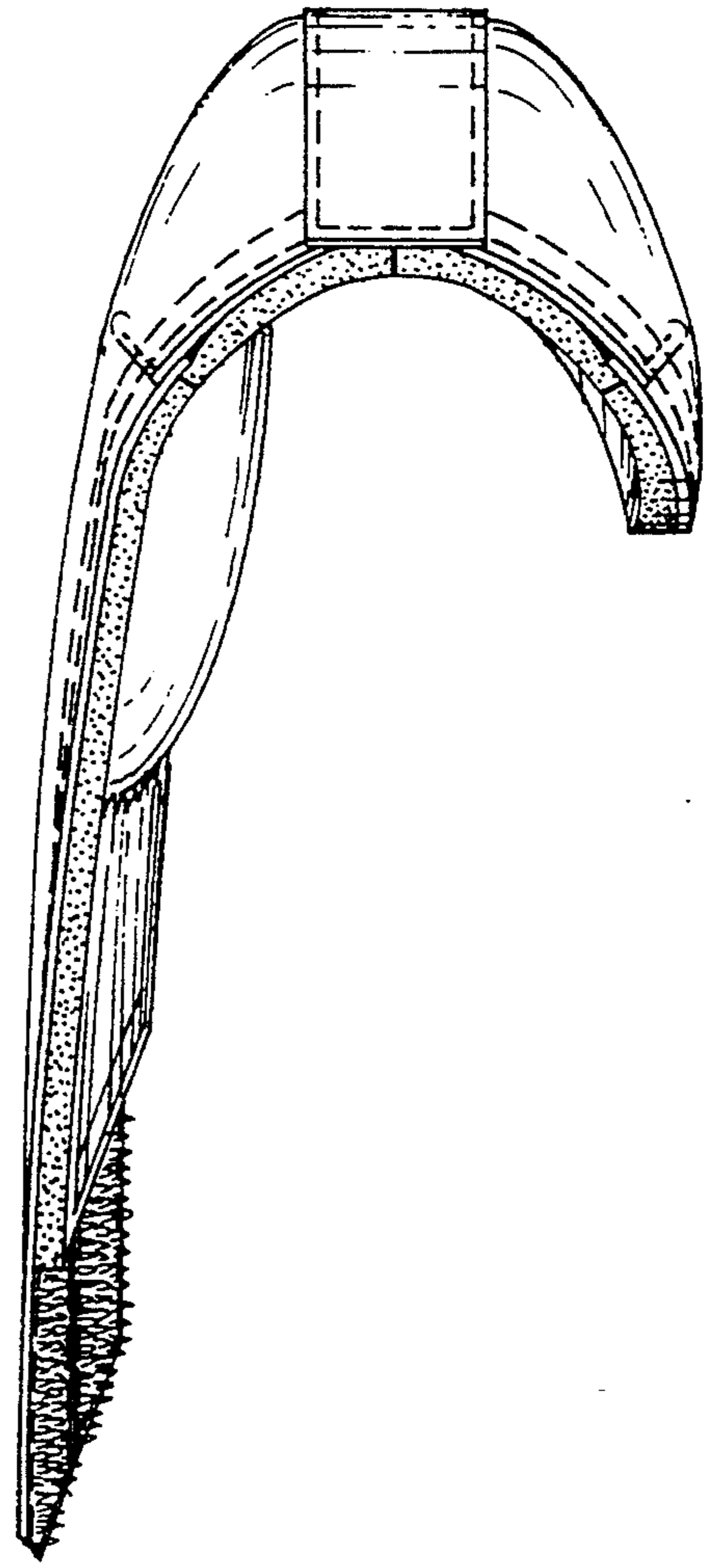

Figure 30