



US00D352332S

United States Patent [19]

[11] Patent Number: Des. 352,332

Hancock

[45] Date of Patent: ** Nov. 8, 1994

[54] **GAME PIECE SET FOR A BOARD GAME**

[75] Inventor: **Craig M. Hancock**, Irvine, Calif.

[73] Assignee: **The Pod Group**, Sepulveda, Calif.

[**] Term: **14 Years**

[21] Appl. No.: **7,967**

[22] Filed: **May 6, 1993**

[52] U.S. Cl. **D21/51**

[58] Field of Search **273/236-286, 273/288; D21/14-36, 48, 51, 52, 129, 131**

[56] **References Cited**

U.S. PATENT DOCUMENTS

| | | | | |
|------------|---------|--------|-------|---------|
| D. 174,817 | 5/1955 | Kenyon | | D21/51 |
| D. 226,202 | 1/1973 | Rossi | | 273/288 |
| D. 289,187 | 4/1987 | Ohno | | D21/131 |
| D. 289,537 | 4/1987 | Leung | | D21/129 |
| 3,730,527 | 5/1973 | Nelson | | 273/258 |
| 3,929,337 | 12/1975 | Hayes | | 273/260 |
| 3,984,109 | 10/1976 | Wiles | | 273/288 |

FOREIGN PATENT DOCUMENTS

| | | | | |
|--------|--------|----------------|-------|---------|
| 921277 | 3/1963 | United Kingdom | | 273/258 |
|--------|--------|----------------|-------|---------|

Primary Examiner—Bernard Ansher

Assistant Examiner—Sandra Morris

Attorney, Agent, or Firm—Kelly, Bauersfeld & Lowry

[57] **CLAIM**

The ornamental design for a game piece set for a board game, as shown.

DESCRIPTION

FIG. 1 is a reduced perspective view of a game piece set for a board game, embodying my new design;

FIG. 2 is a top, front and left side perspective view of a first game piece;

FIG. 3 is a top plan view thereof;

FIG. 4 is a front elevational view thereof;

FIG. 5 is a right side elevational view thereof;

FIG. 6 is a bottom plan view thereof;

FIG. 7 is a rear elevational view thereof;

FIG. 8 is a top, front and left side perspective view of a second game piece;

FIG. 9 is a top plan view thereof;

FIG. 10 is a front elevational view thereof;

FIG. 10a is a right side elevational view thereof;

FIG. 11 is a bottom plan view thereof;

FIG. 12 is a rear elevational view thereof;

FIG. 13 is a top, front and left side elevational view of a third game piece;

FIG. 14 is a top plan view thereof;

FIG. 15 is a right side elevational view thereof;

FIG. 16 is a front elevational view thereof;

FIG. 17 is a left side elevational view thereof;

FIG. 18 is a bottom plan view thereof;

FIG. 19 is a rear elevational view thereof;

FIG. 20 is a top, front and left side perspective view of a fourth game piece;

FIG. 21 is a top plan view thereof;

FIG. 22 is a right side elevational view thereof;

FIG. 23 is a front elevational view thereof;

FIG. 24 is a bottom plan view thereof;

FIG. 25 is a rear elevational view thereof;

FIG. 26 is a top, front and left side perspective view of a fifth game piece;

FIG. 27 is a top plan view thereof;

FIG. 28 is a right side elevational view thereof;

FIG. 29 is a front elevational view thereof;

FIG. 30 is a rear elevational view thereof;

FIG. 31 is a top, front and left side perspective view of a sixth game piece;

FIG. 32 is a top plan view thereof;

FIG. 33 is a right side elevational view thereof;

FIG. 34 is a front elevational view thereof;

FIG. 35 is a bottom plan view thereof;

FIG. 36 is a rear elevational view thereof;

FIG. 37 is a top, front and left side perspective view of a seventh game piece;

FIG. 38 is a top plan view thereof;

FIG. 39 is a left side elevational view thereof;

FIG. 40 is a front elevational view thereof;

FIG. 41 is a right side elevational view thereof;

FIG. 42 is a bottom plan view thereof;

FIG. 43 is a rear elevational view thereof;

FIG. 44 is a top, front and left side perspective view of an eighth game piece;

FIG. 45 is a top plan view thereof;

FIG. 46 is a left side elevational view thereof;

(Description continued on next page.)

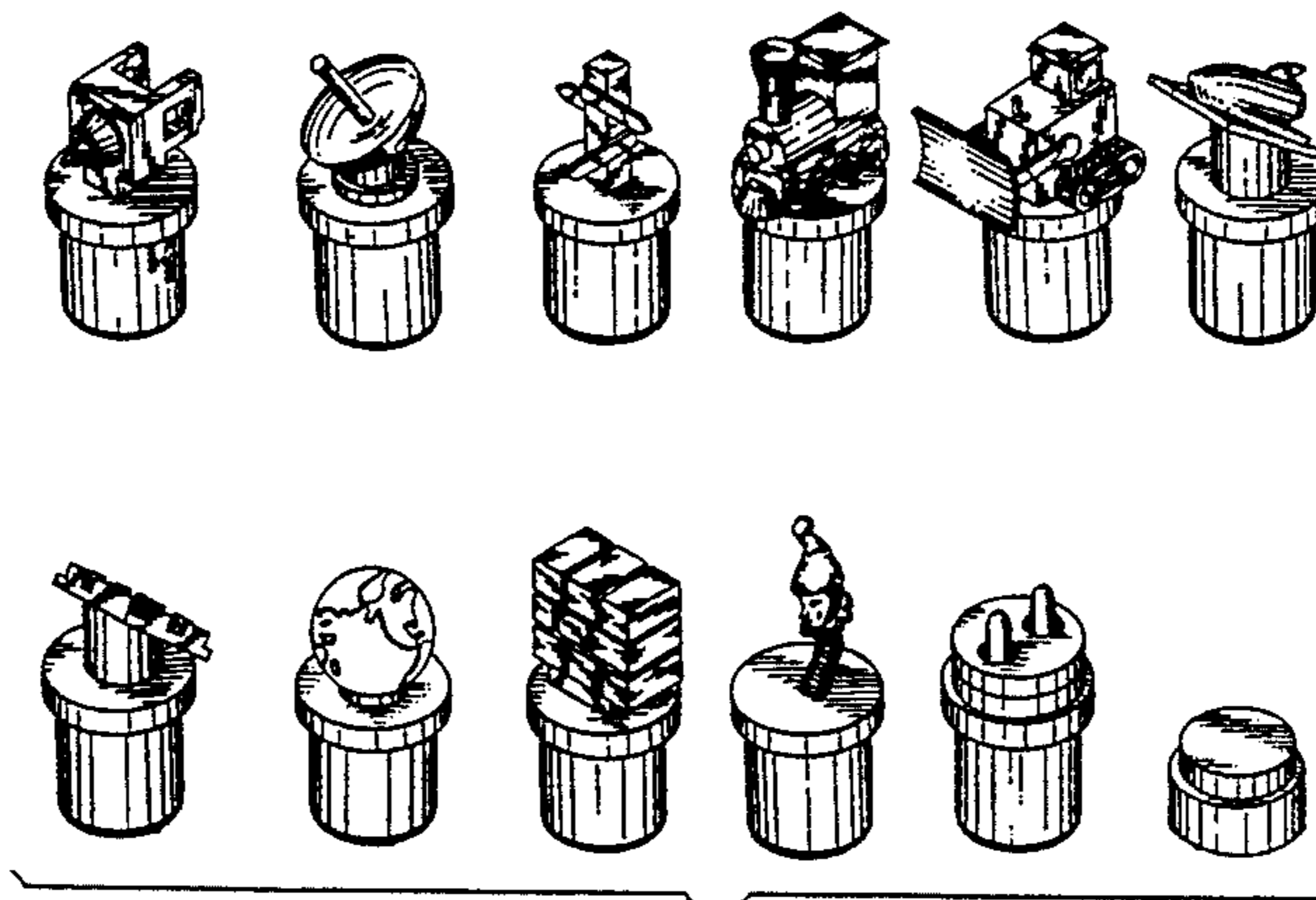

FIG. 47 is a front elevational view thereof;
FIG. 48 is a left side elevational view thereof;
FIG. 49 is a bottom plan view thereof;
FIG. 50 is a rear elevational view thereof;
FIG. 51 is a top, front and left side perspective view of a ninth game piece;
FIG. 52 is a top plan view thereof;
FIG. 53 is a right side elevational view thereof;
FIG. 54 is a front elevational view thereof;
FIG. 55 is a bottom plan view thereof;
FIG. 56 is a top, front and left side perspective view of a tenth game piece;
FIG. 57 is a top plan view thereof;
FIG. 58 is a right side elevational view thereof;
FIG. 59 is a front elevational view thereof;
FIG. 60 is a left side elevational view thereof;
FIG. 61 is a bottom plan view thereof;

FIG. 62 is a rear elevational view thereof;
FIG. 63 is a top, front and left side perspective view of an eleventh game piece;
FIG. 64 is a top plan view thereof;
FIG. 65 is a right side elevational view thereof, the left side elevational view being a mirror image;
FIG. 66 is a front elevational view thereof, the rear elevational view being a mirror image;
FIG. 67 is a bottom plan view thereof;
FIG. 68 is a top, front and left side perspective view of a plurality of stacked twelfth game pieces;
FIG. 69 is a top plan view of an individual one of said twelfth game pieces;
FIG. 70 is a right side elevational view, the left side elevational view being a mirror image;
FIG. 71 is a front elevational view thereof, the rear elevational view being a mirror image; and,
FIG. 72 is a bottom plan view thereof.

FIG. 2

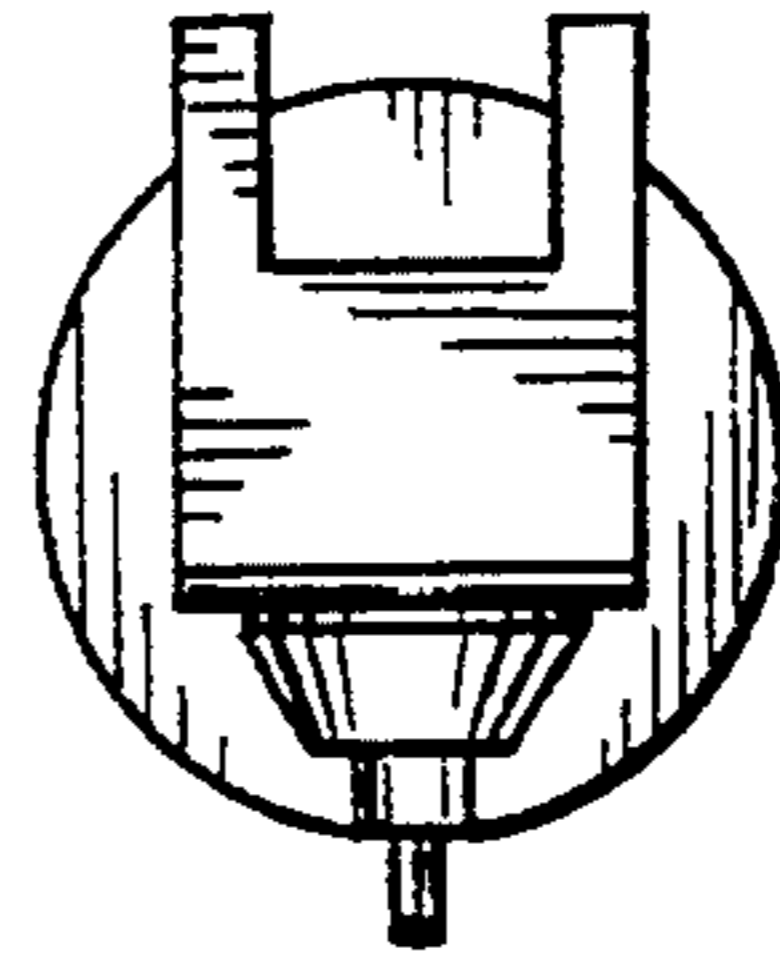
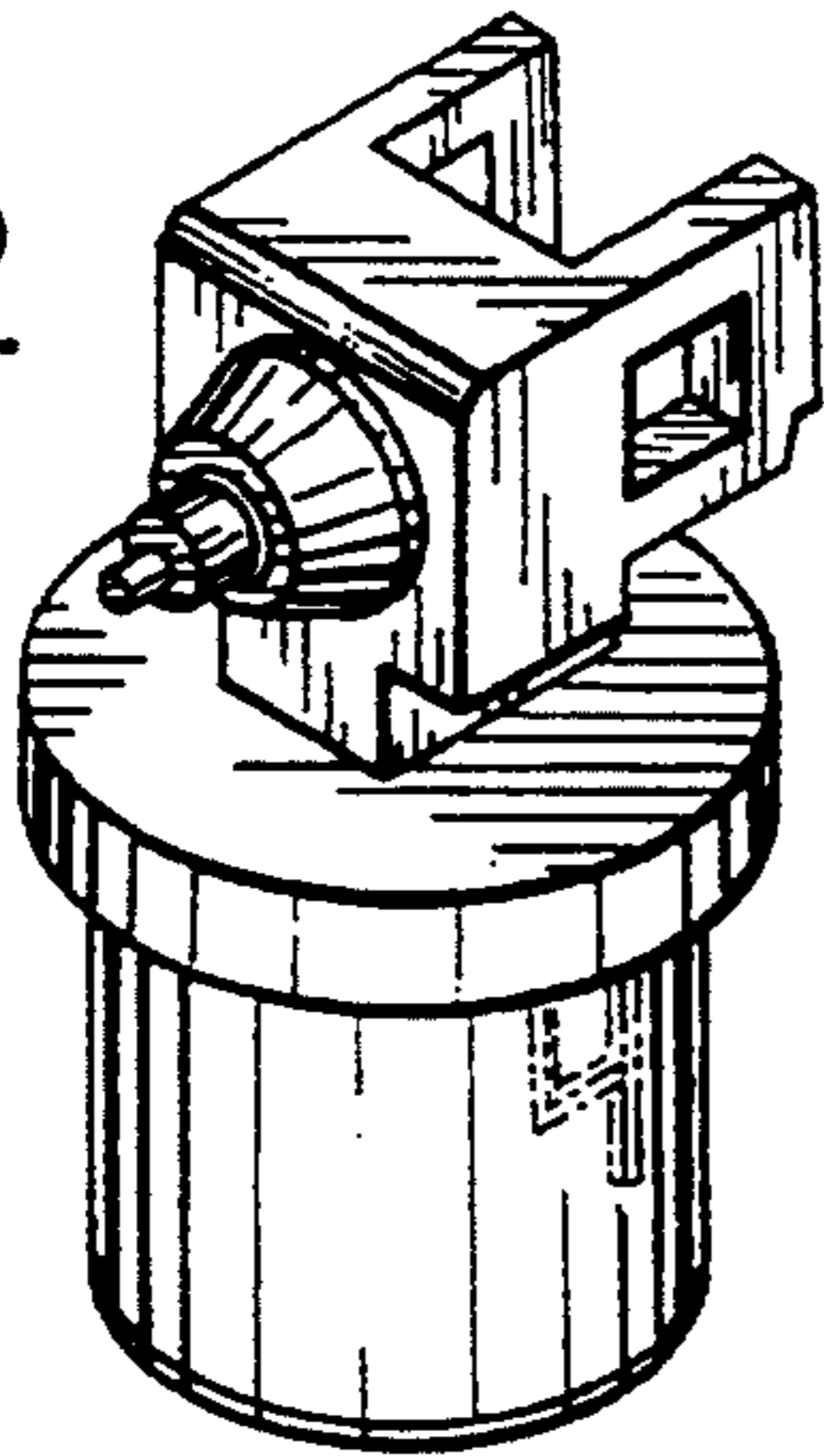

FIG. 3

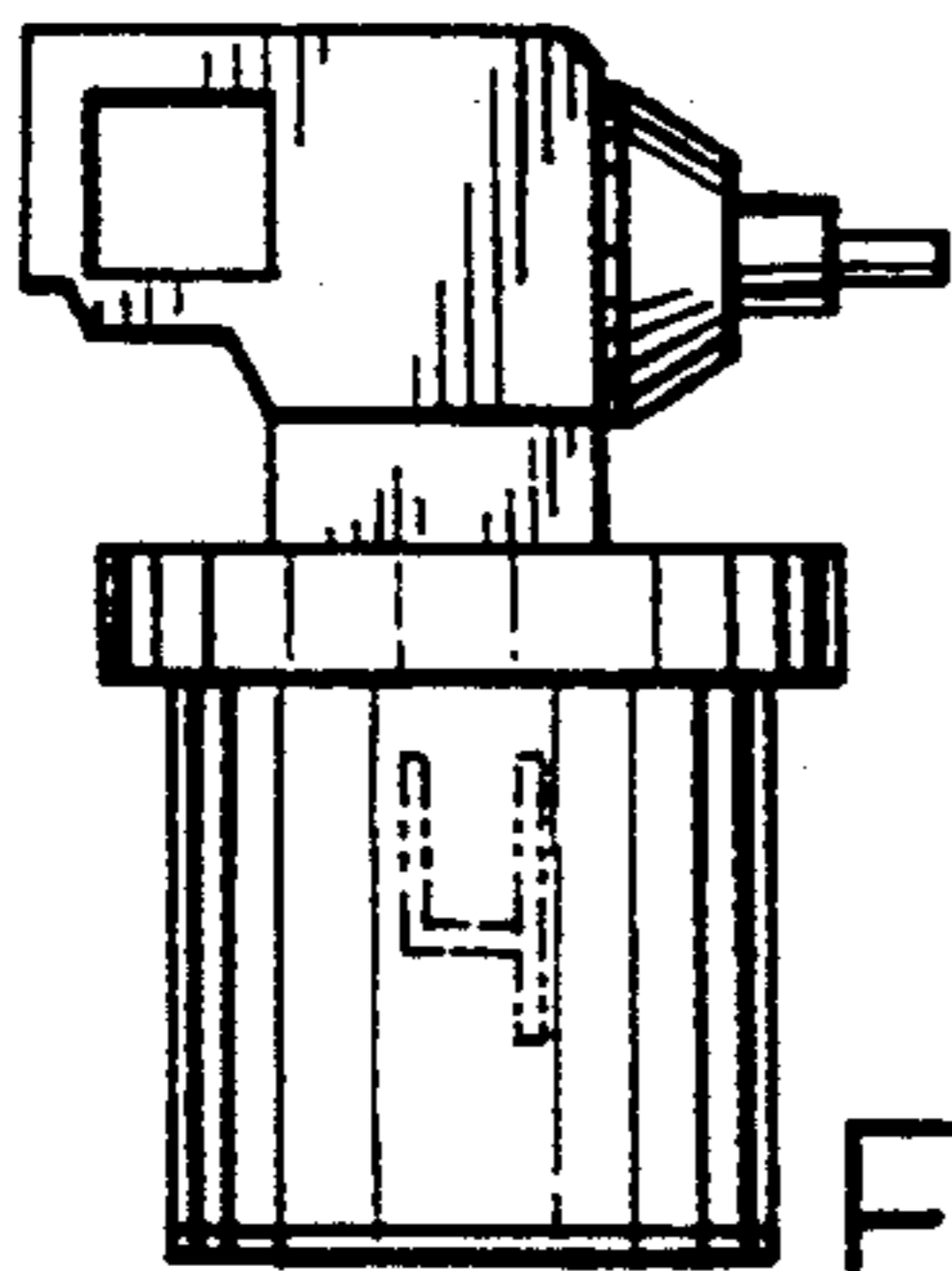

FIG. 5

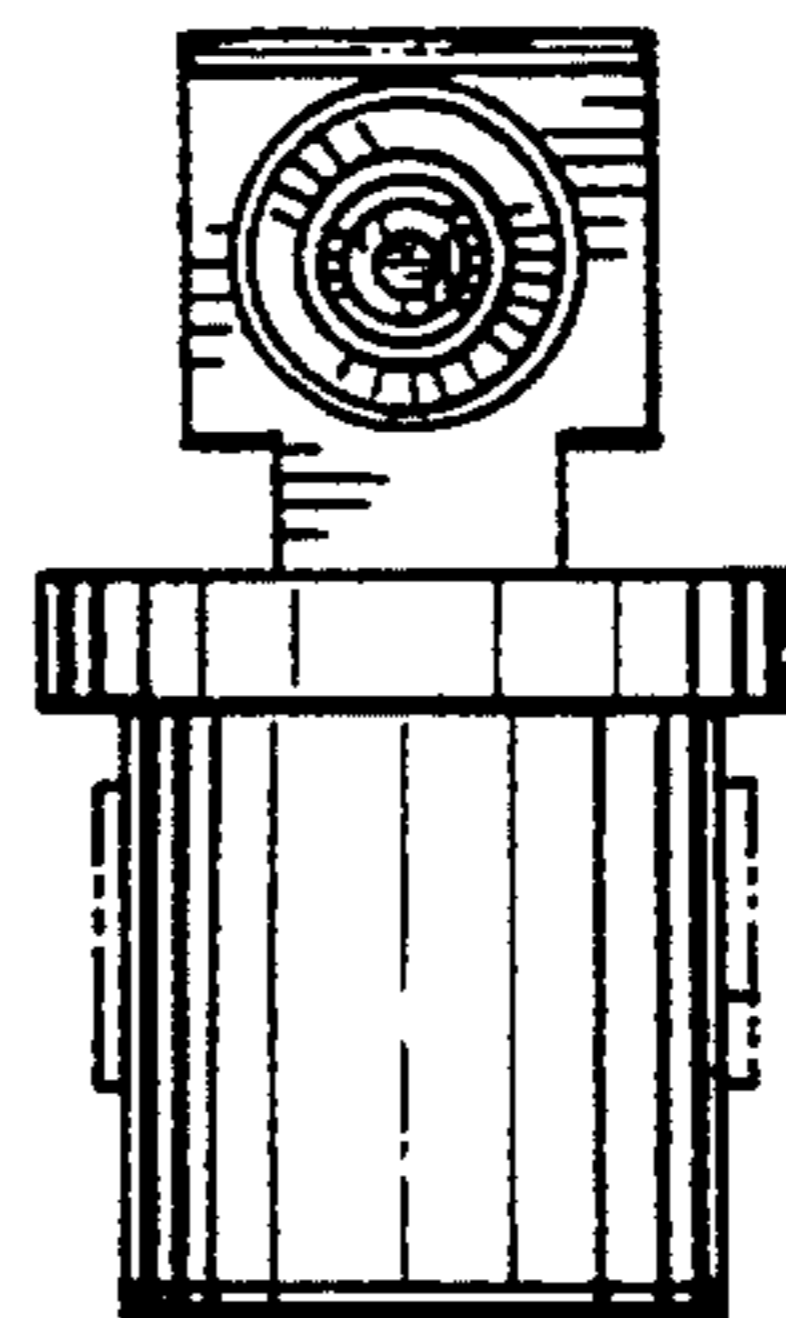

FIG. 4

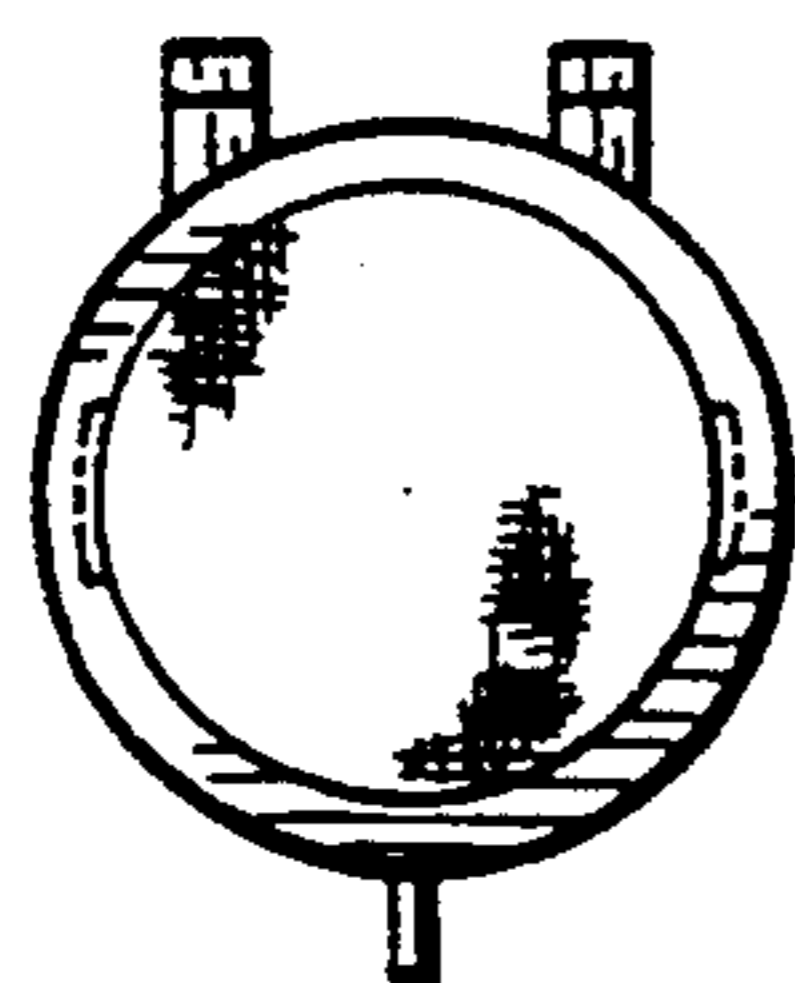

FIG. 6

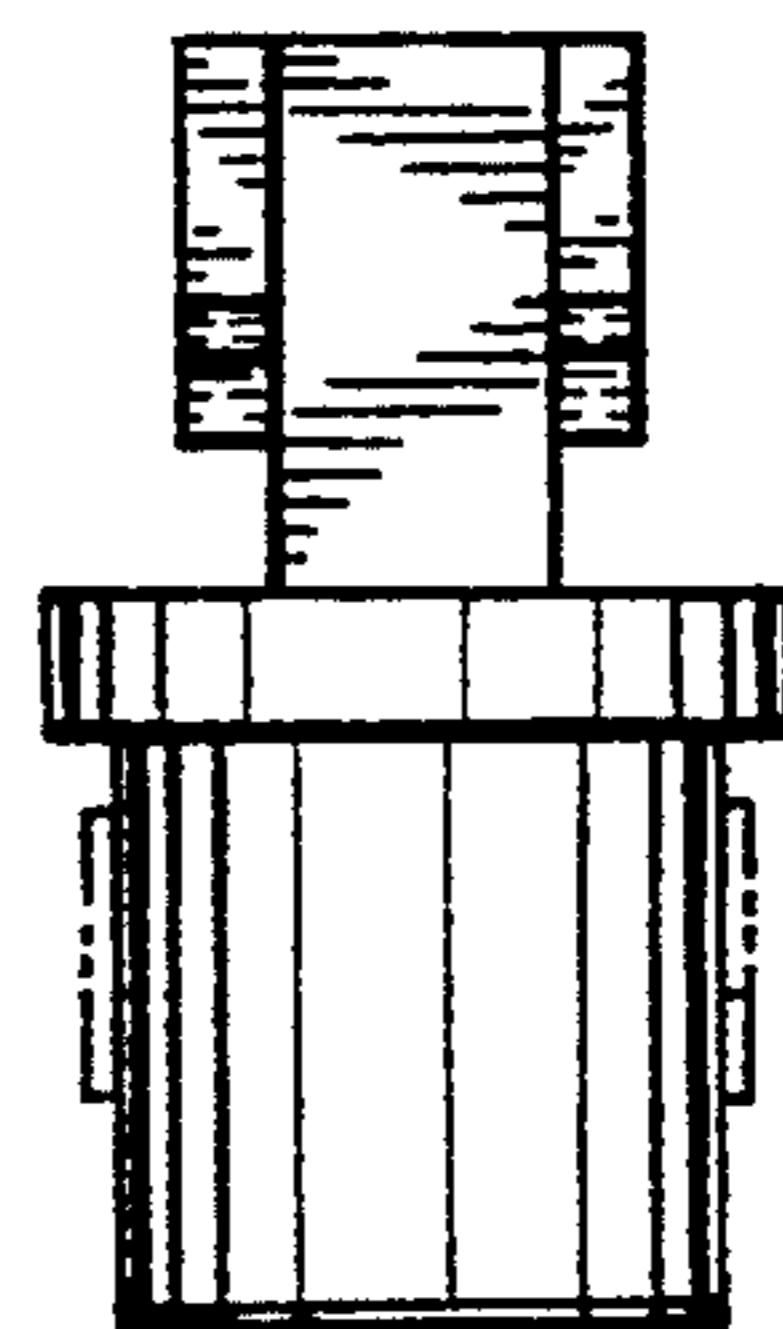
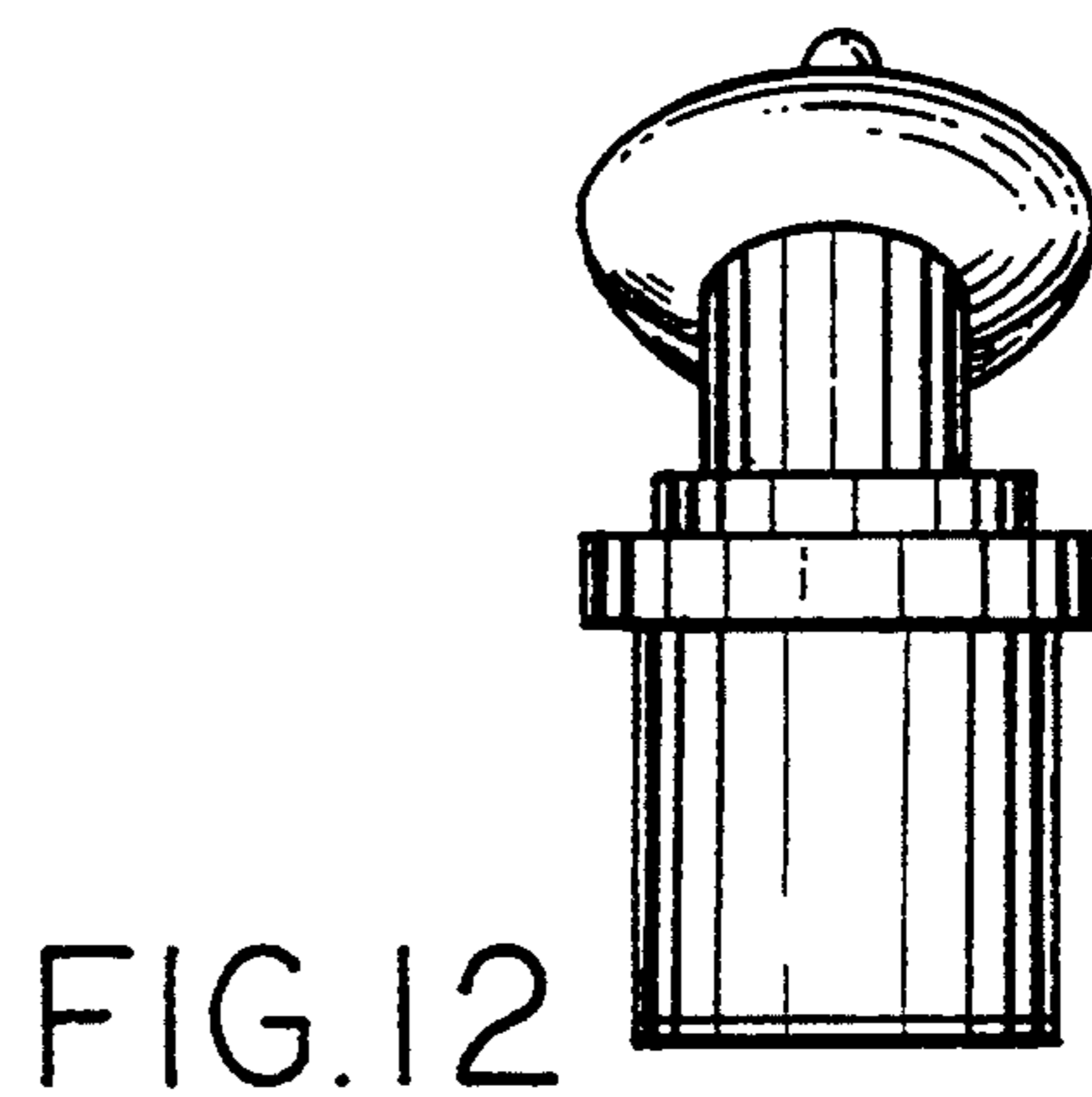
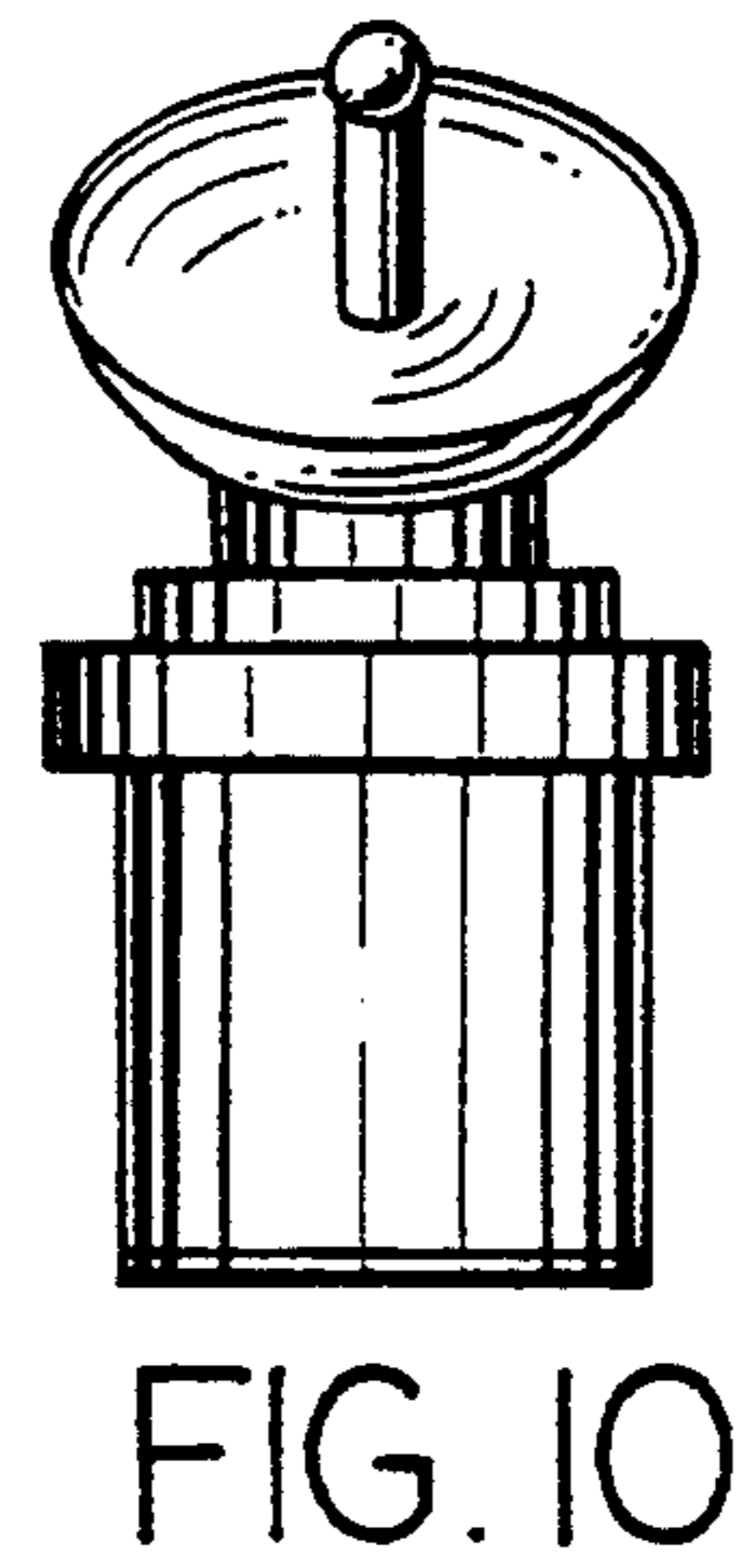
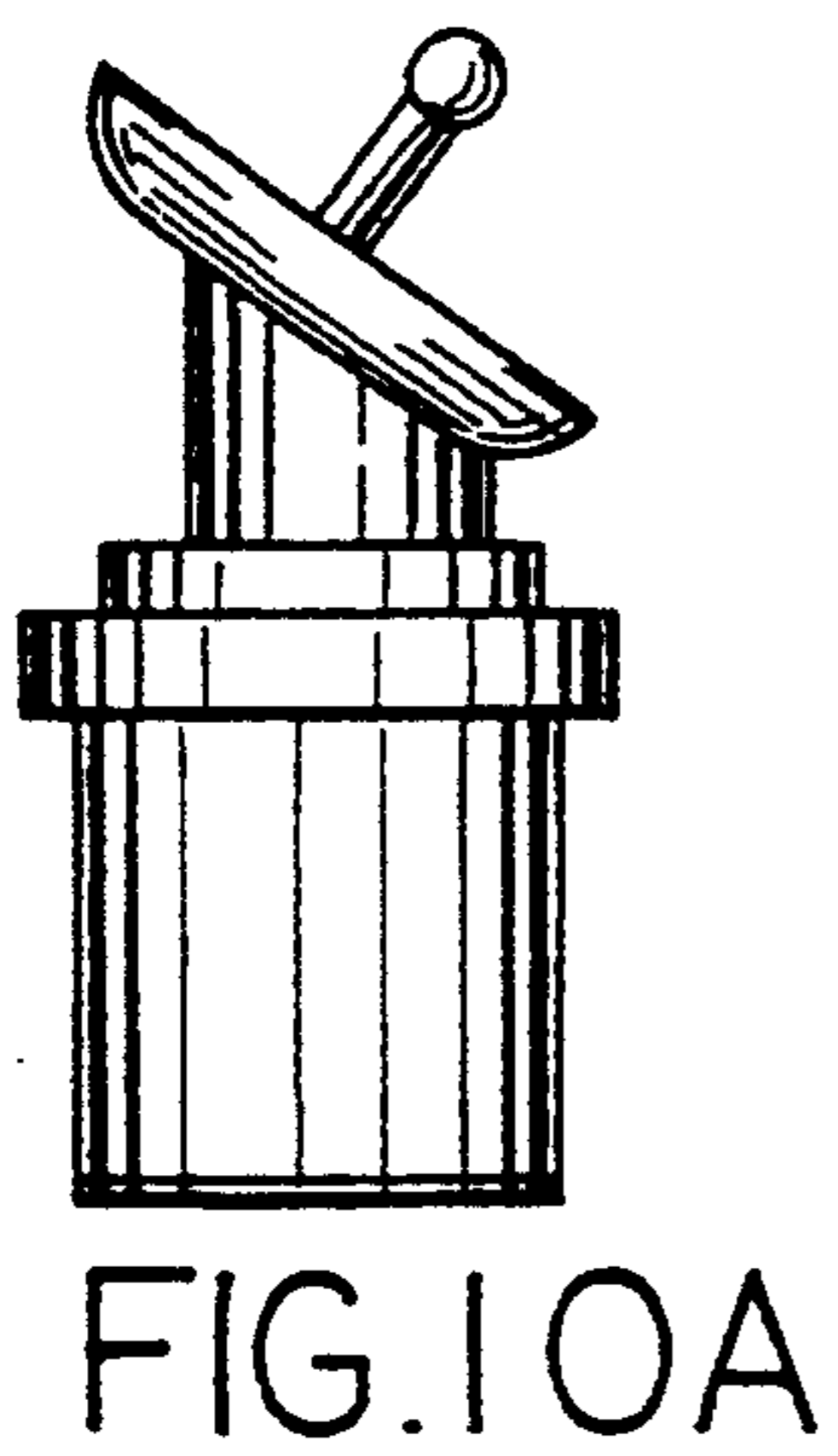
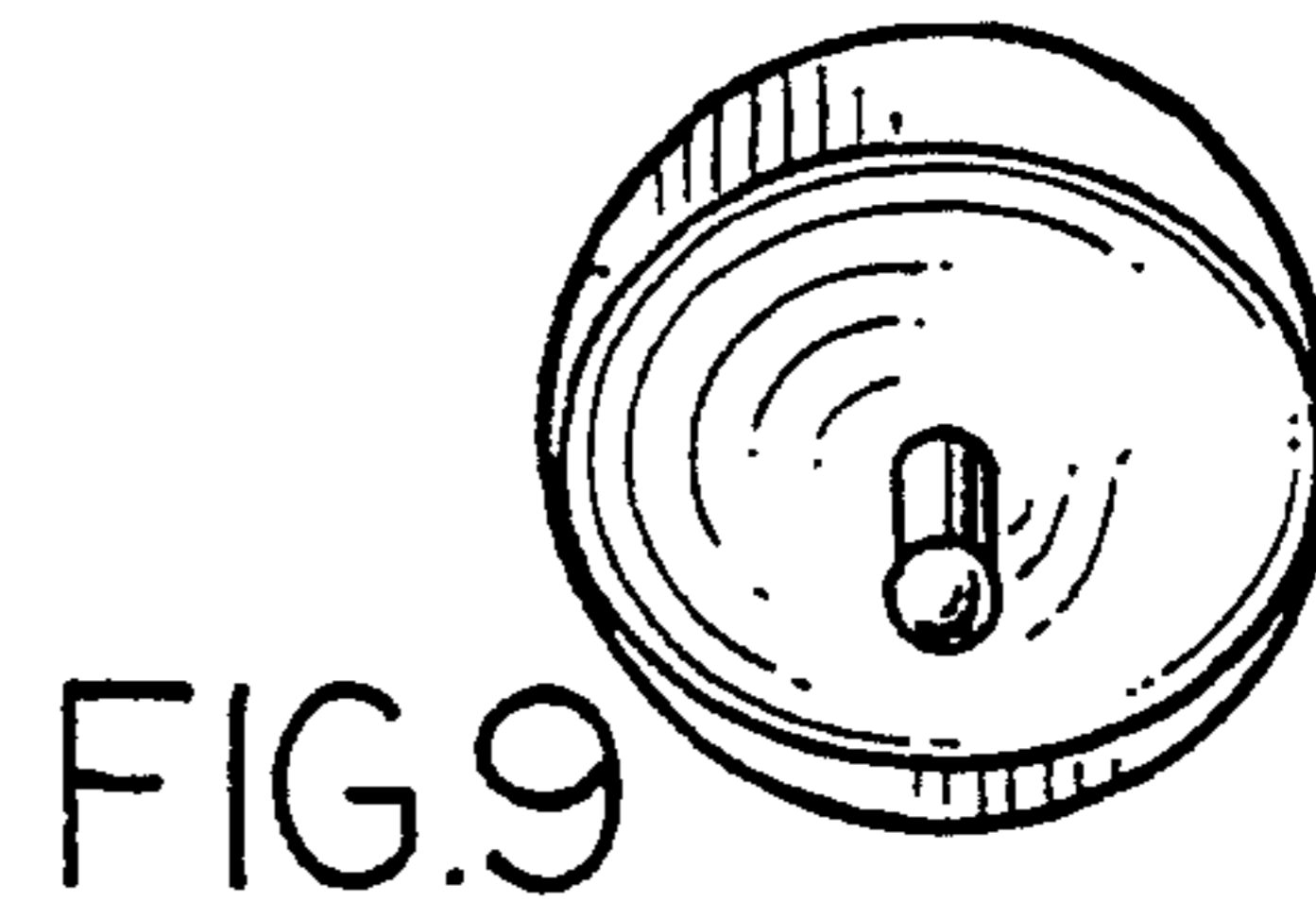
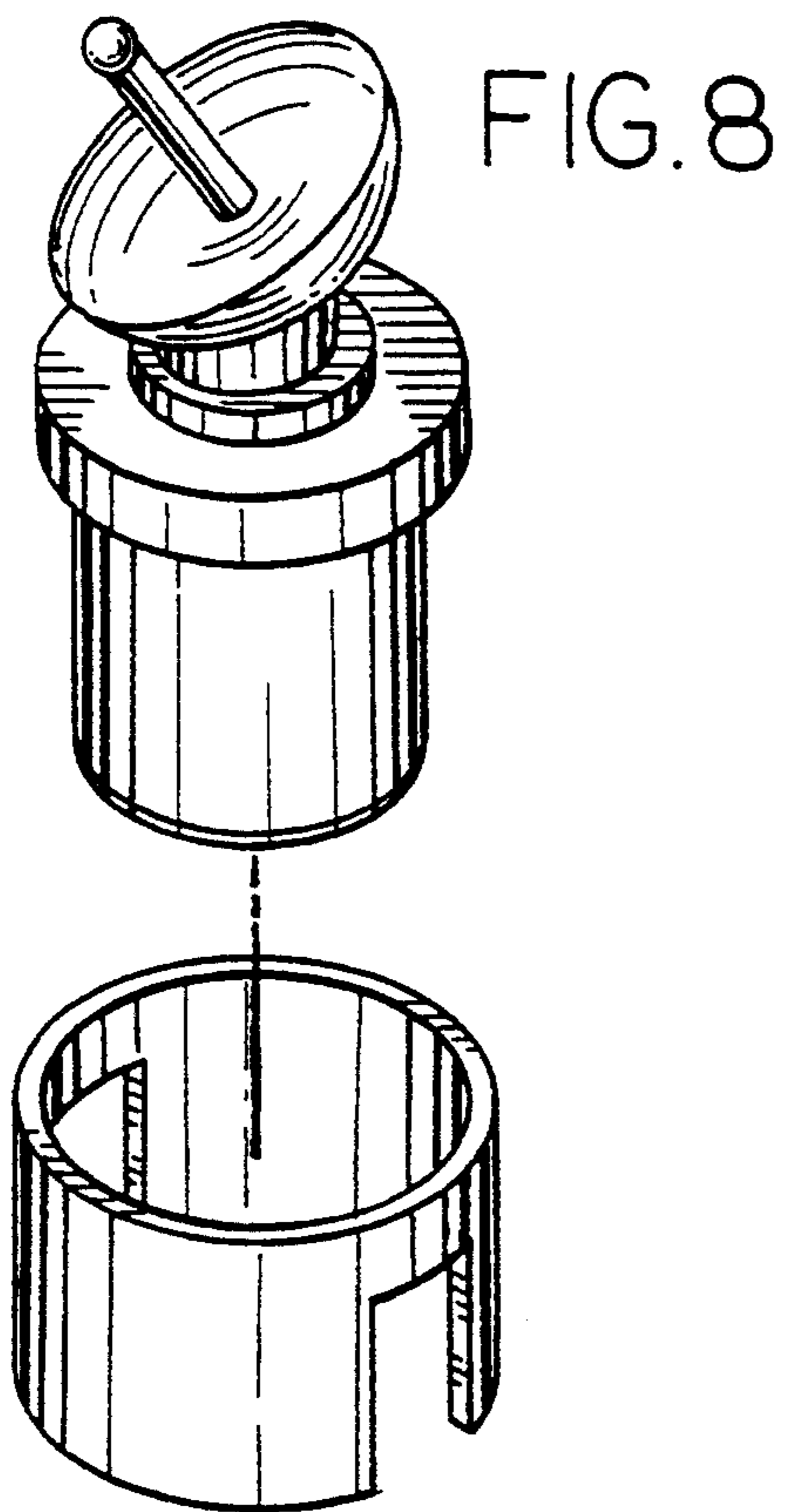

FIG. 7



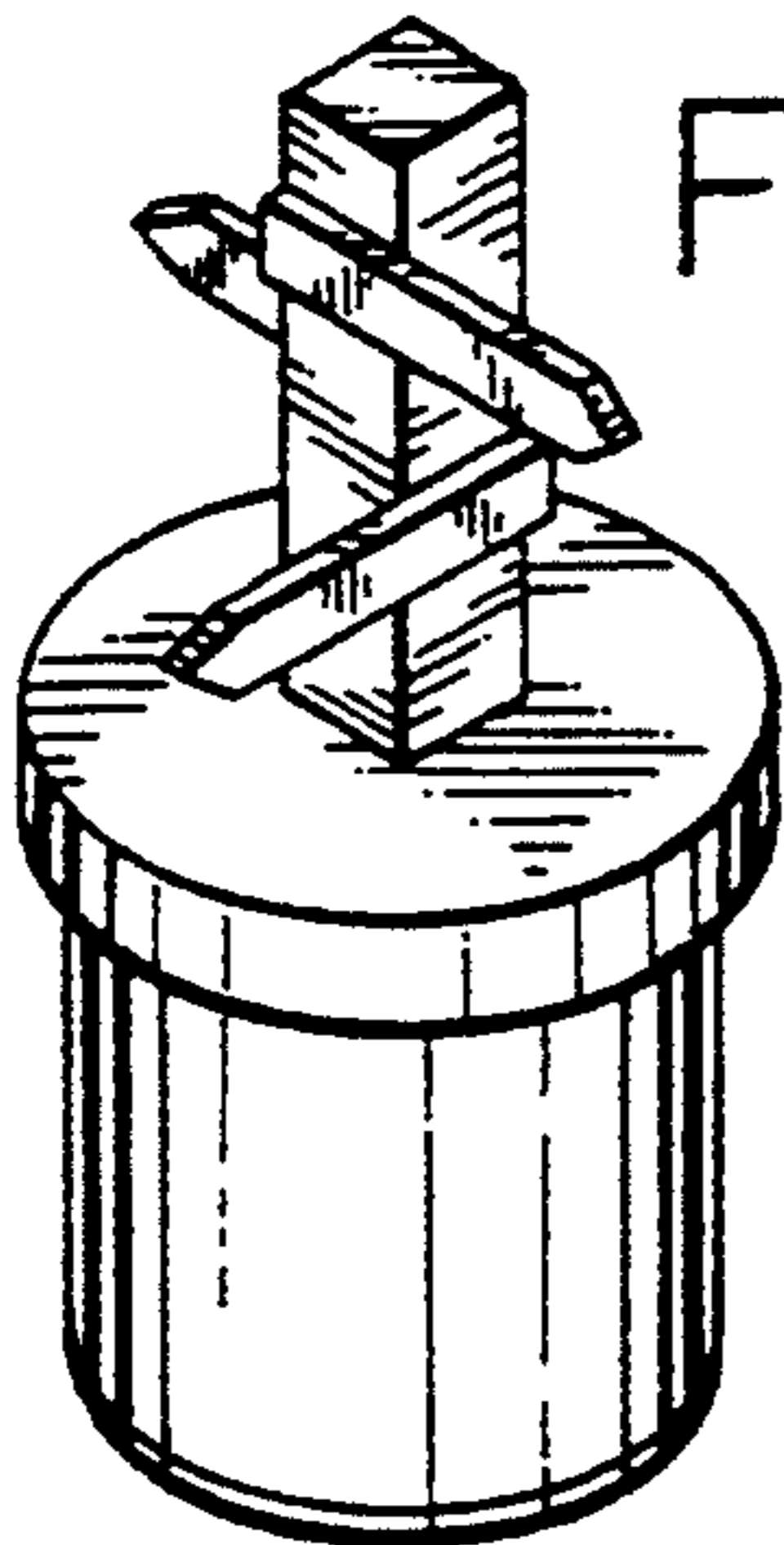

FIG. 13

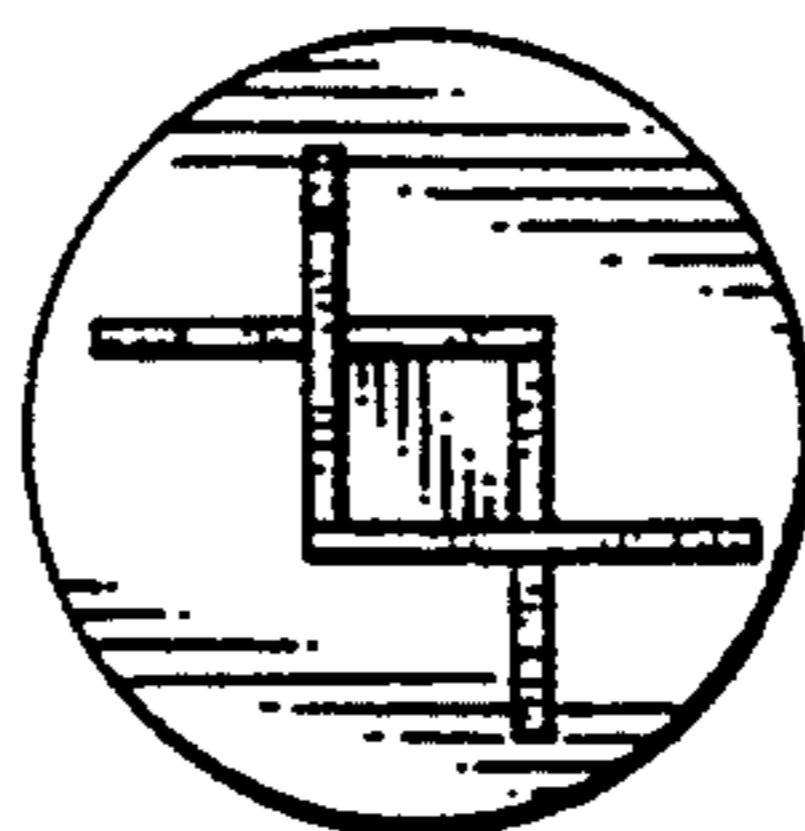

FIG. 14

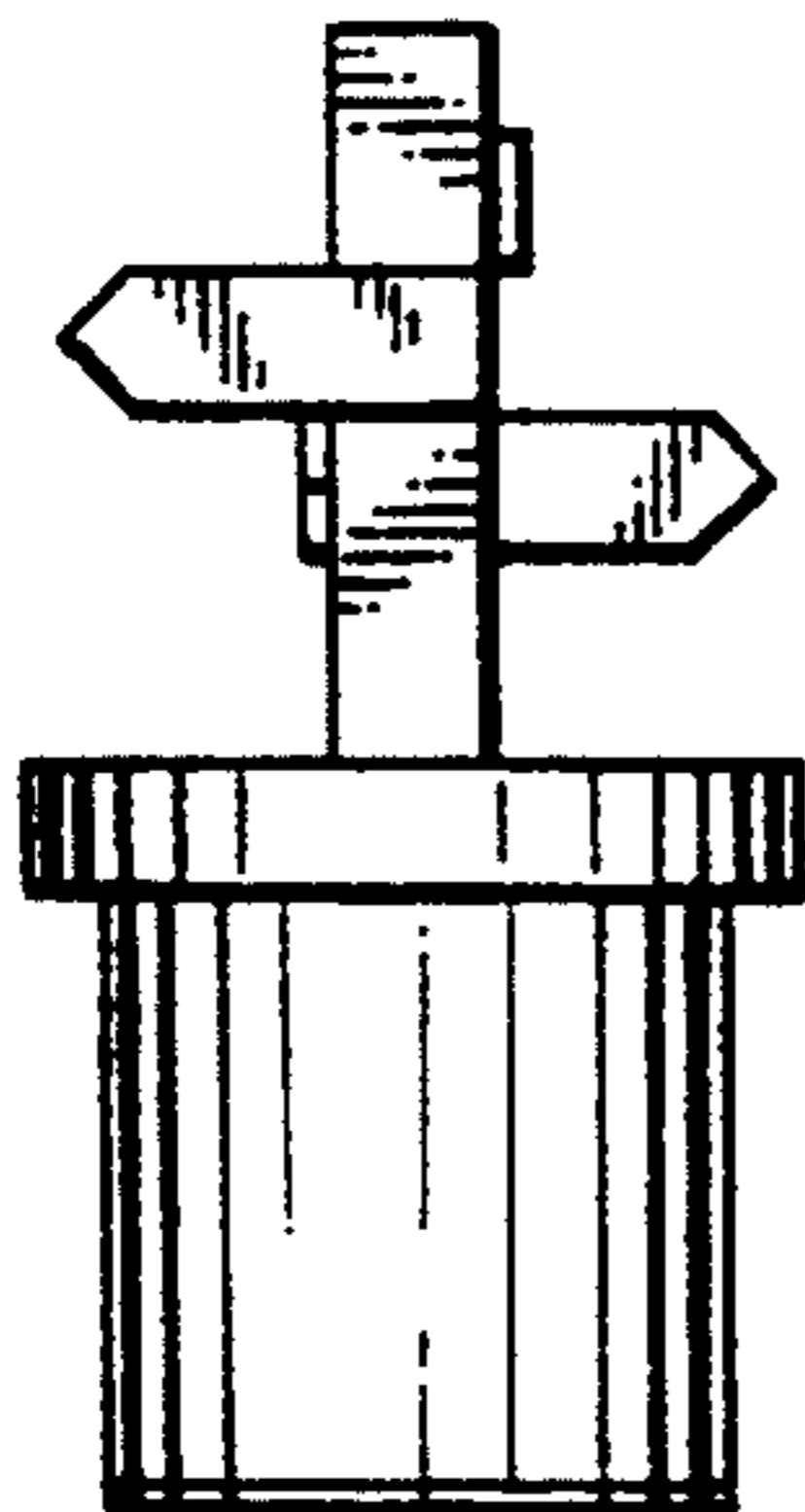

FIG. 15

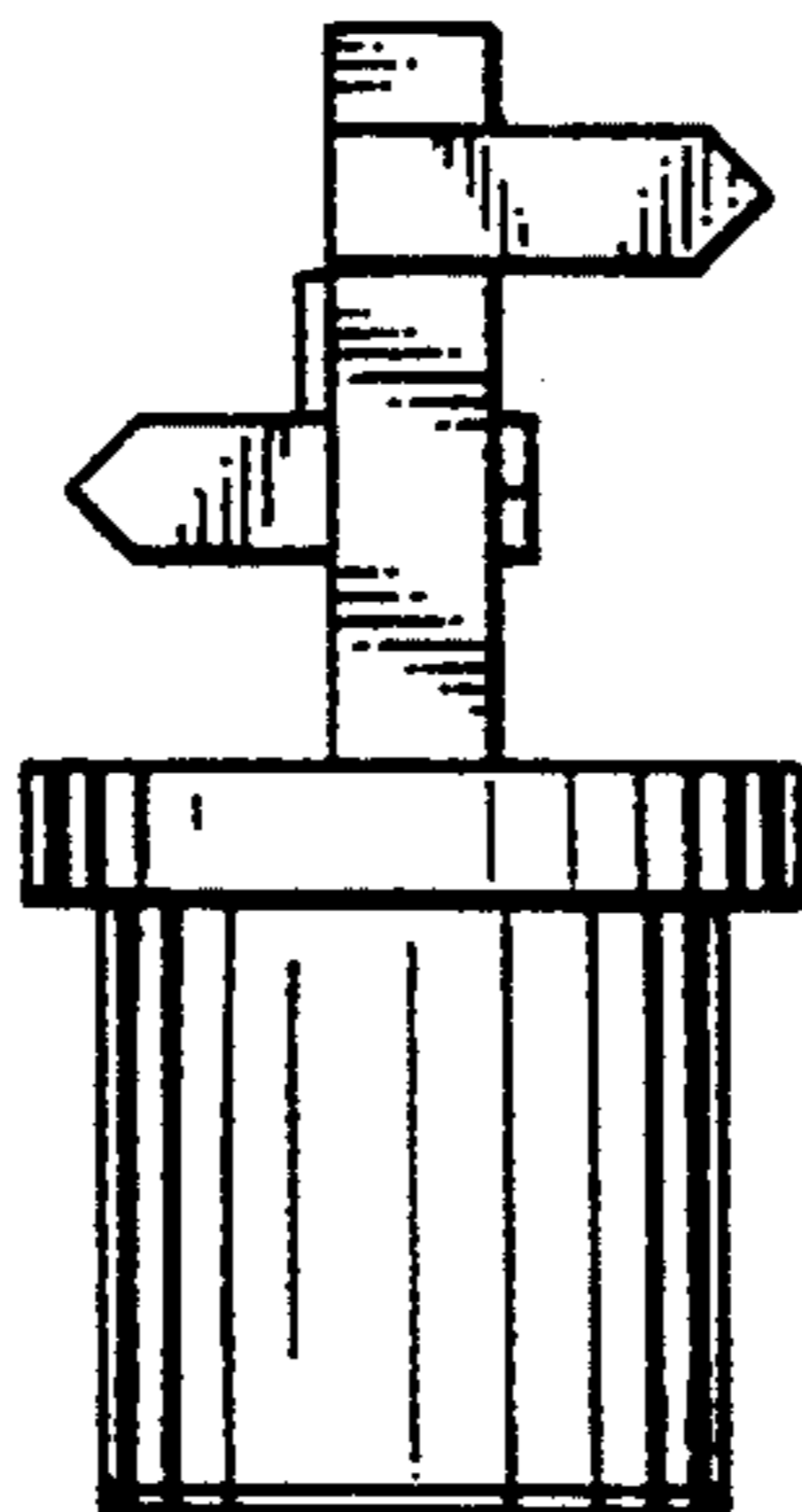

FIG. 16

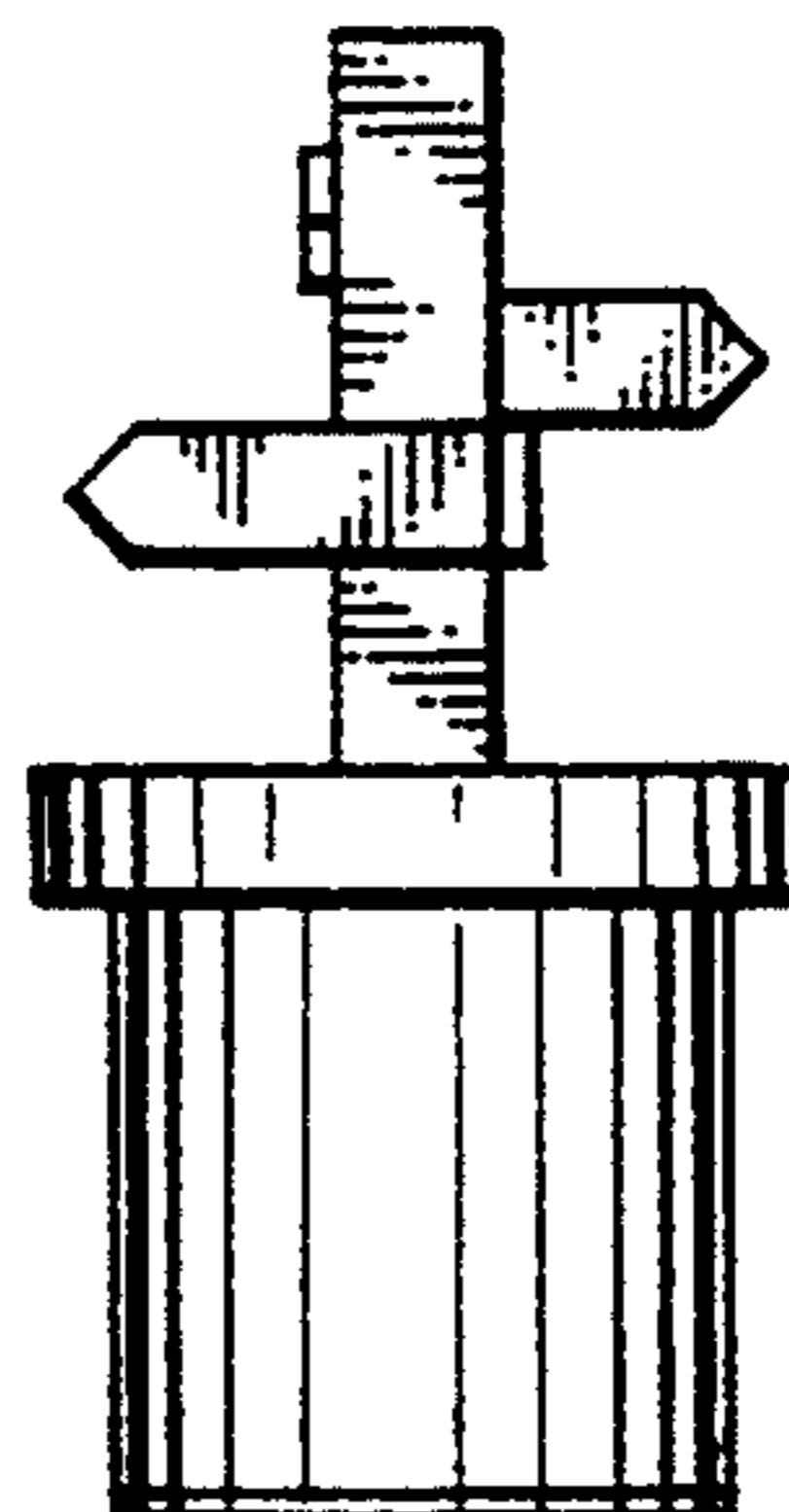

FIG. 17

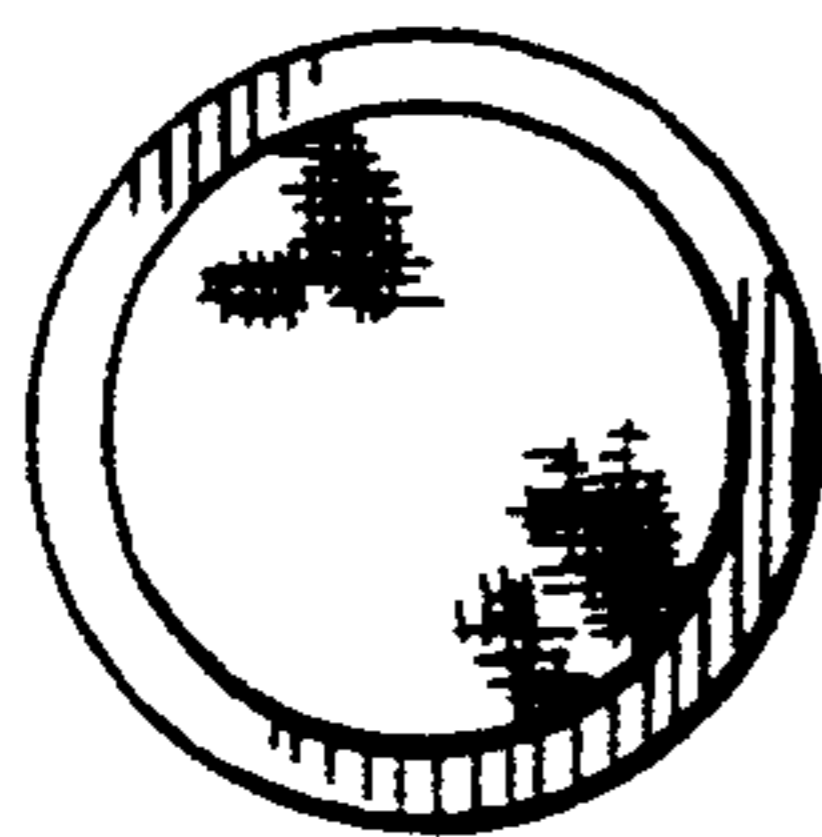

FIG. 18

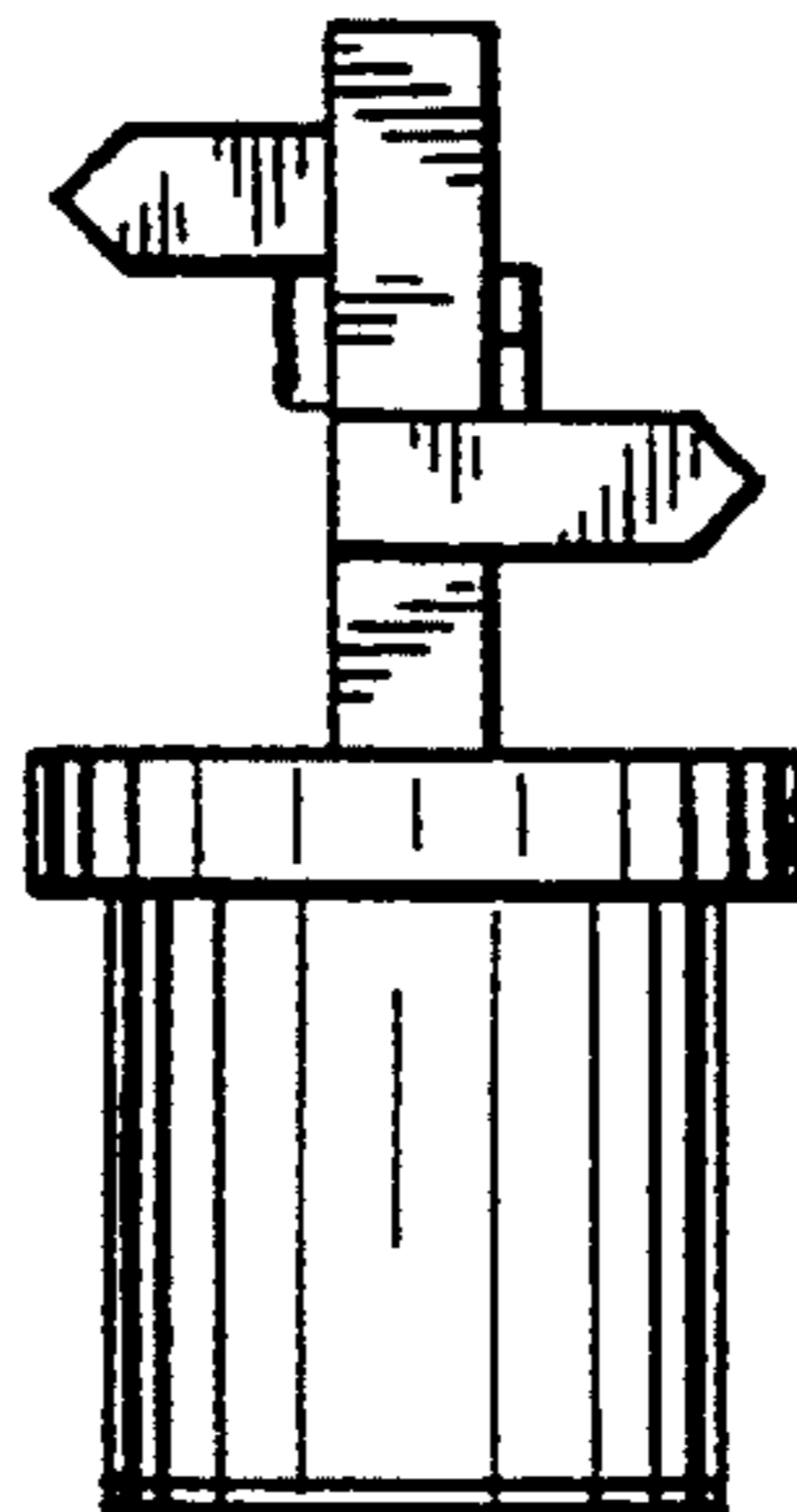

FIG. 19

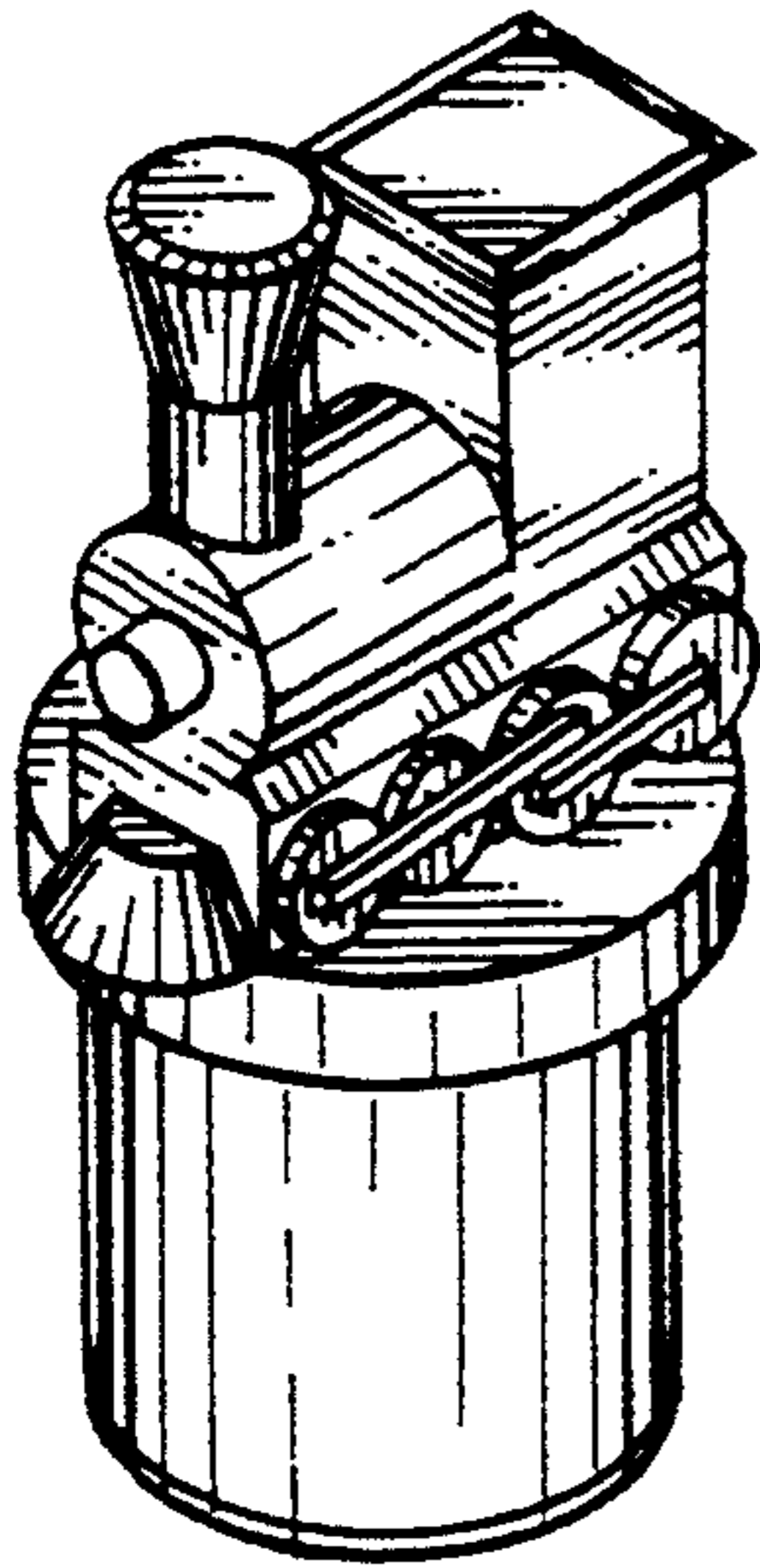

FIG. 20

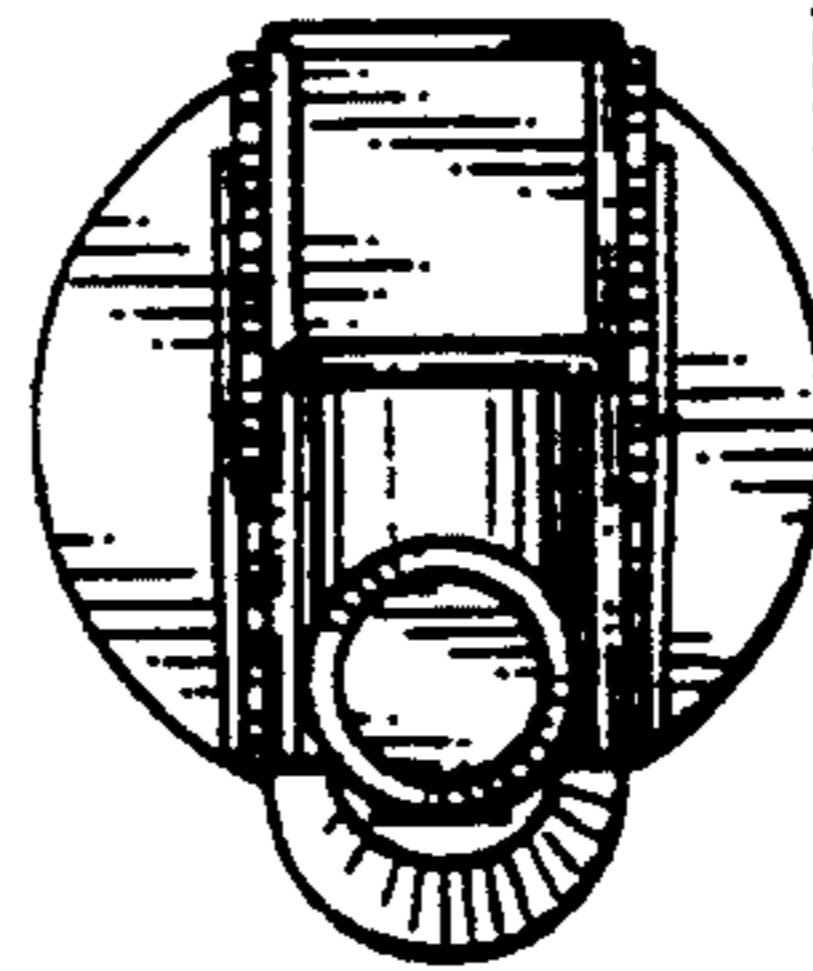

FIG. 21

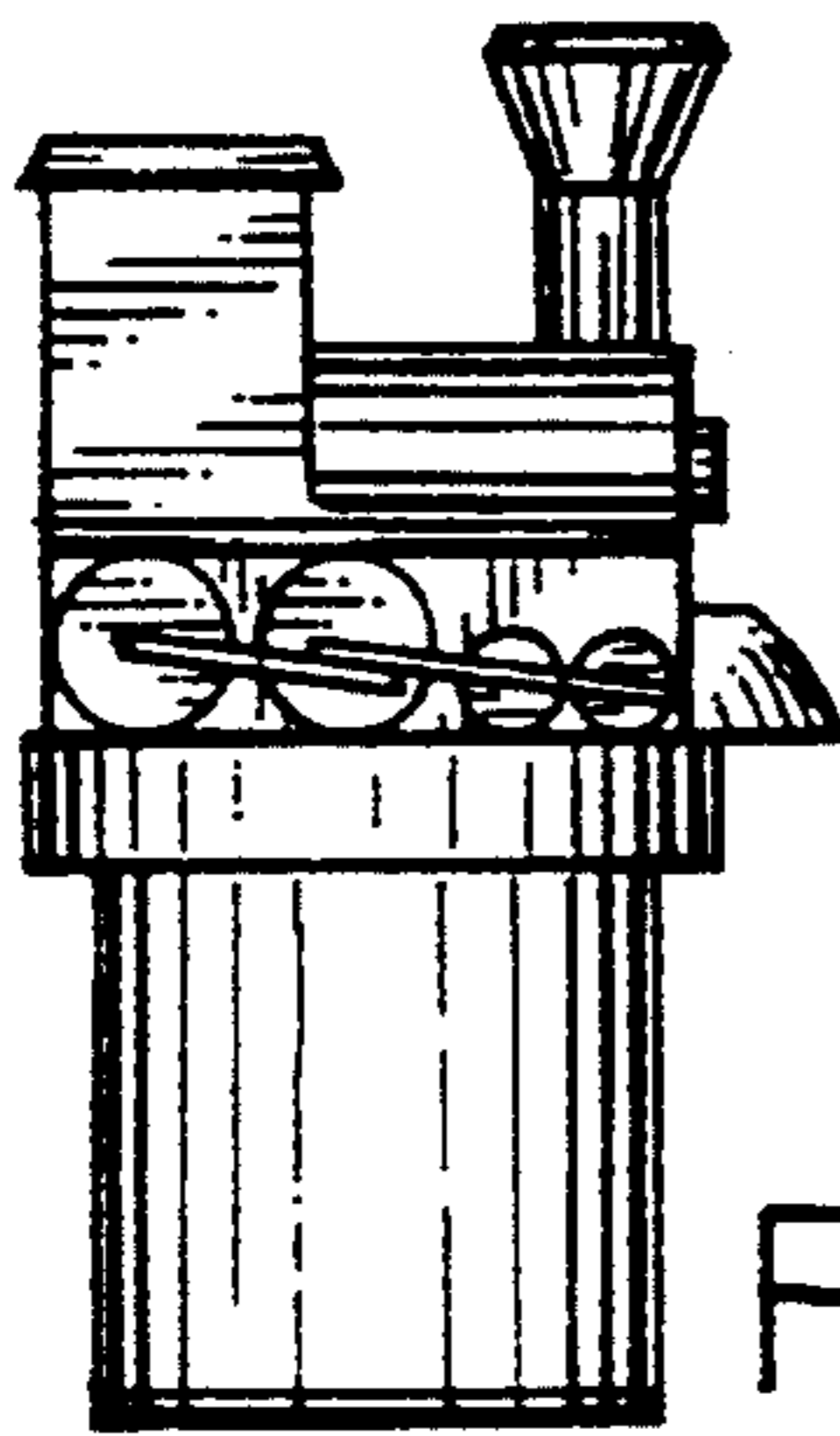

FIG. 22

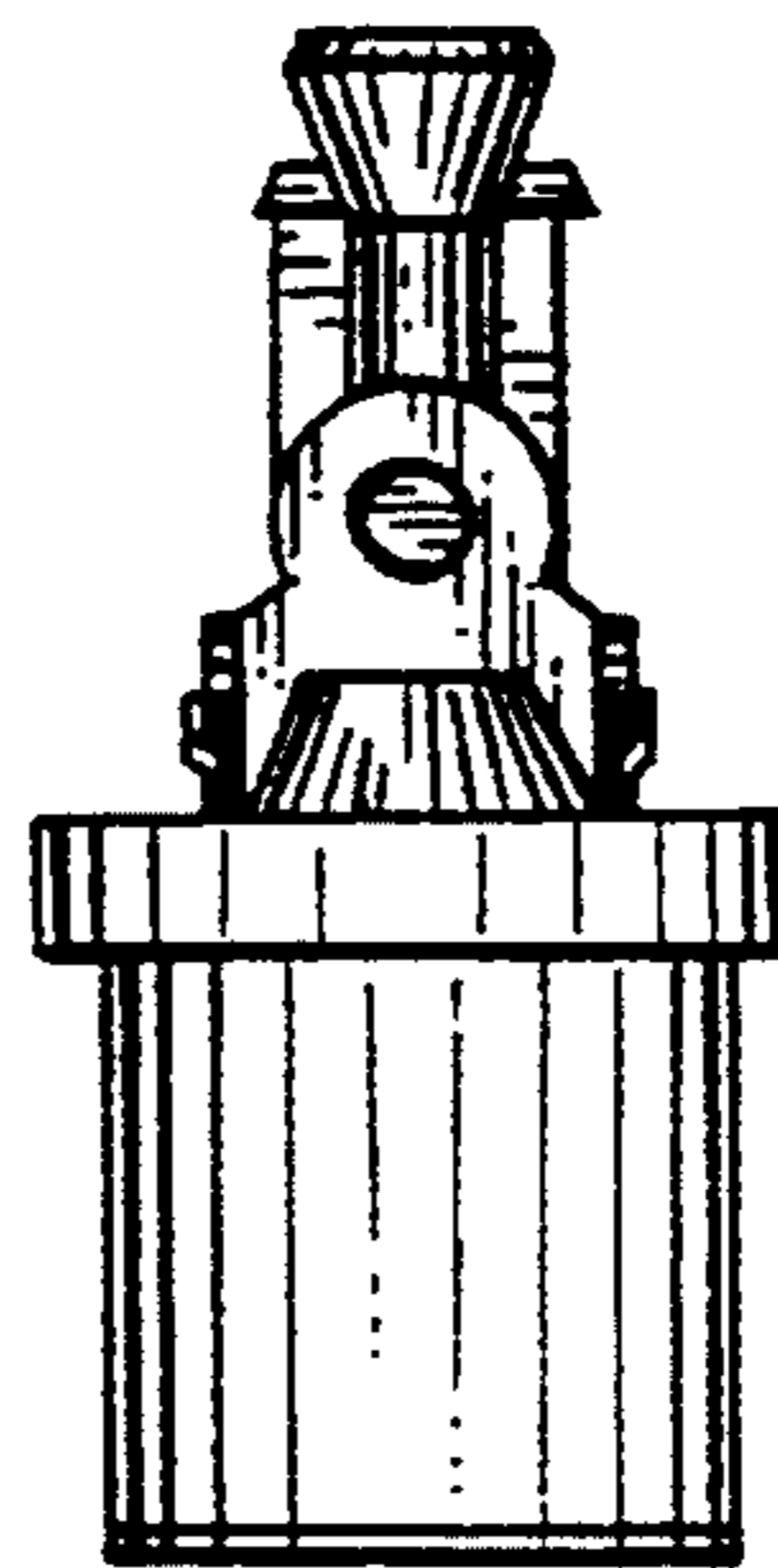

FIG. 23

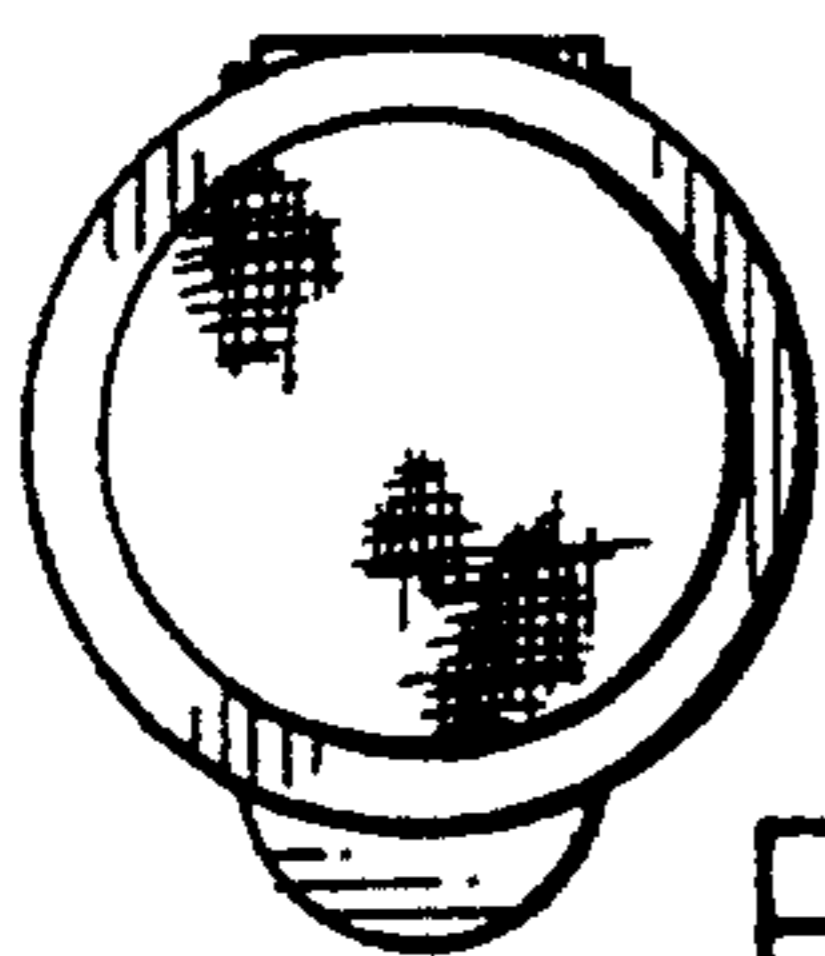

FIG. 24

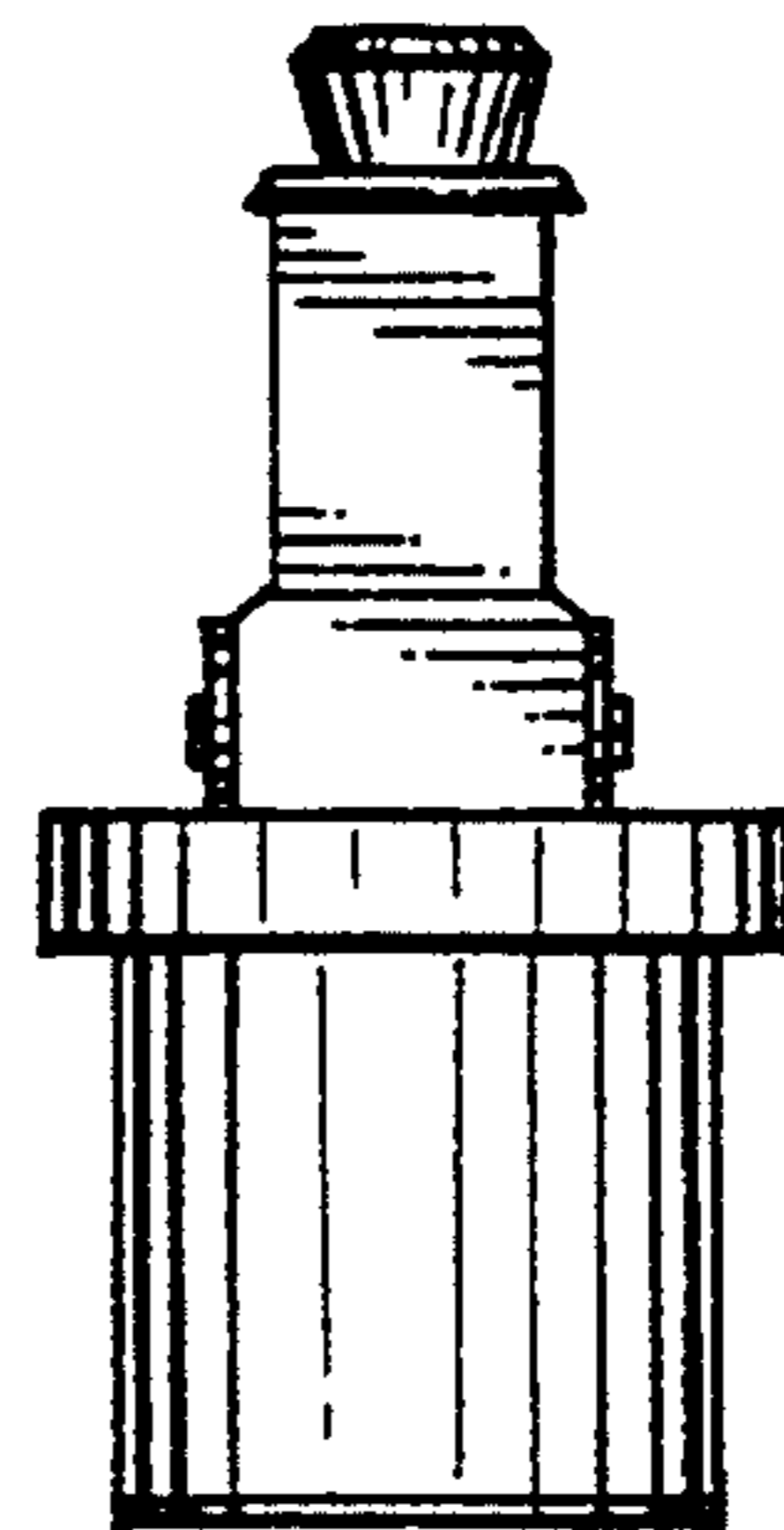

FIG. 25

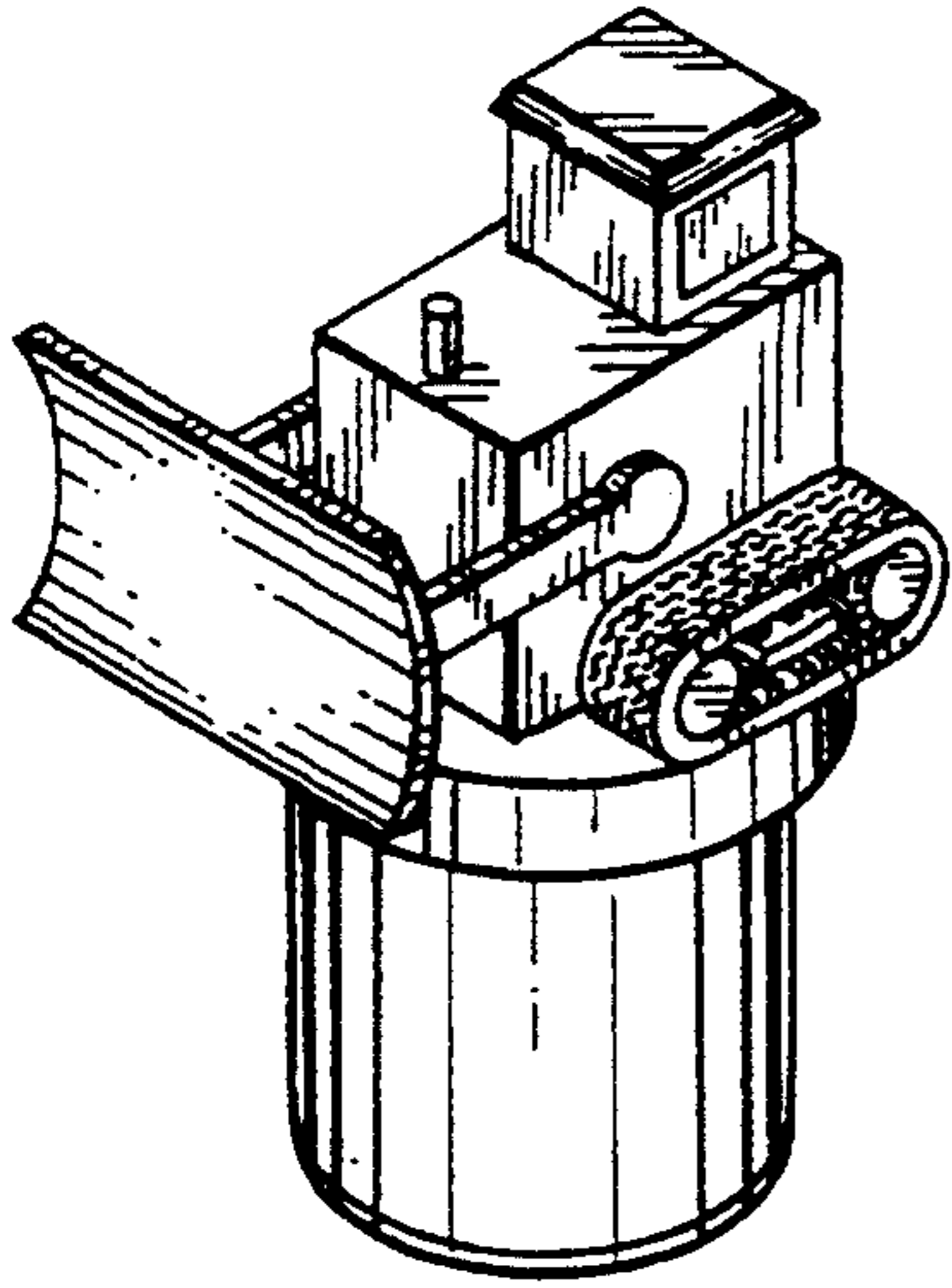

FIG. 26

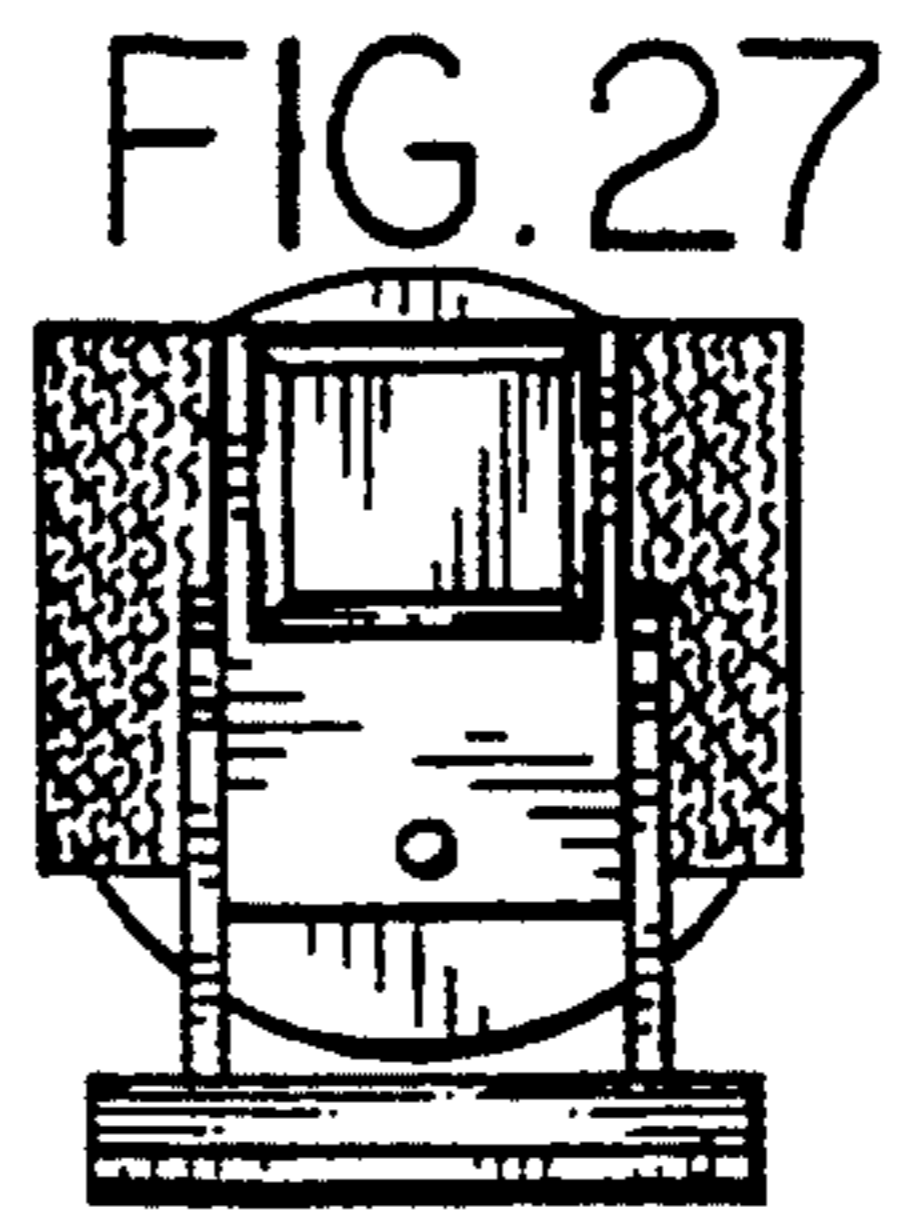

FIG. 27

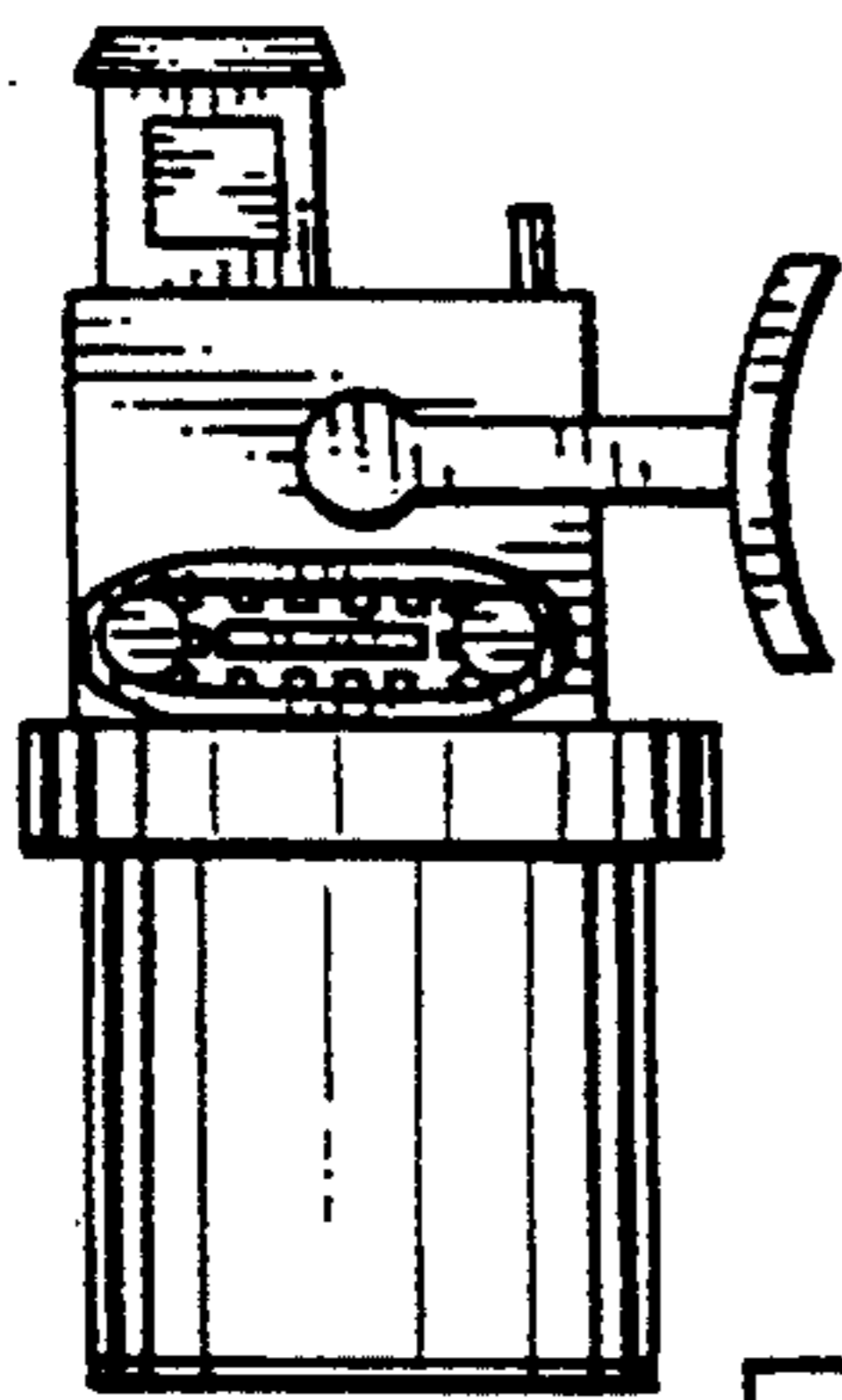

FIG. 28

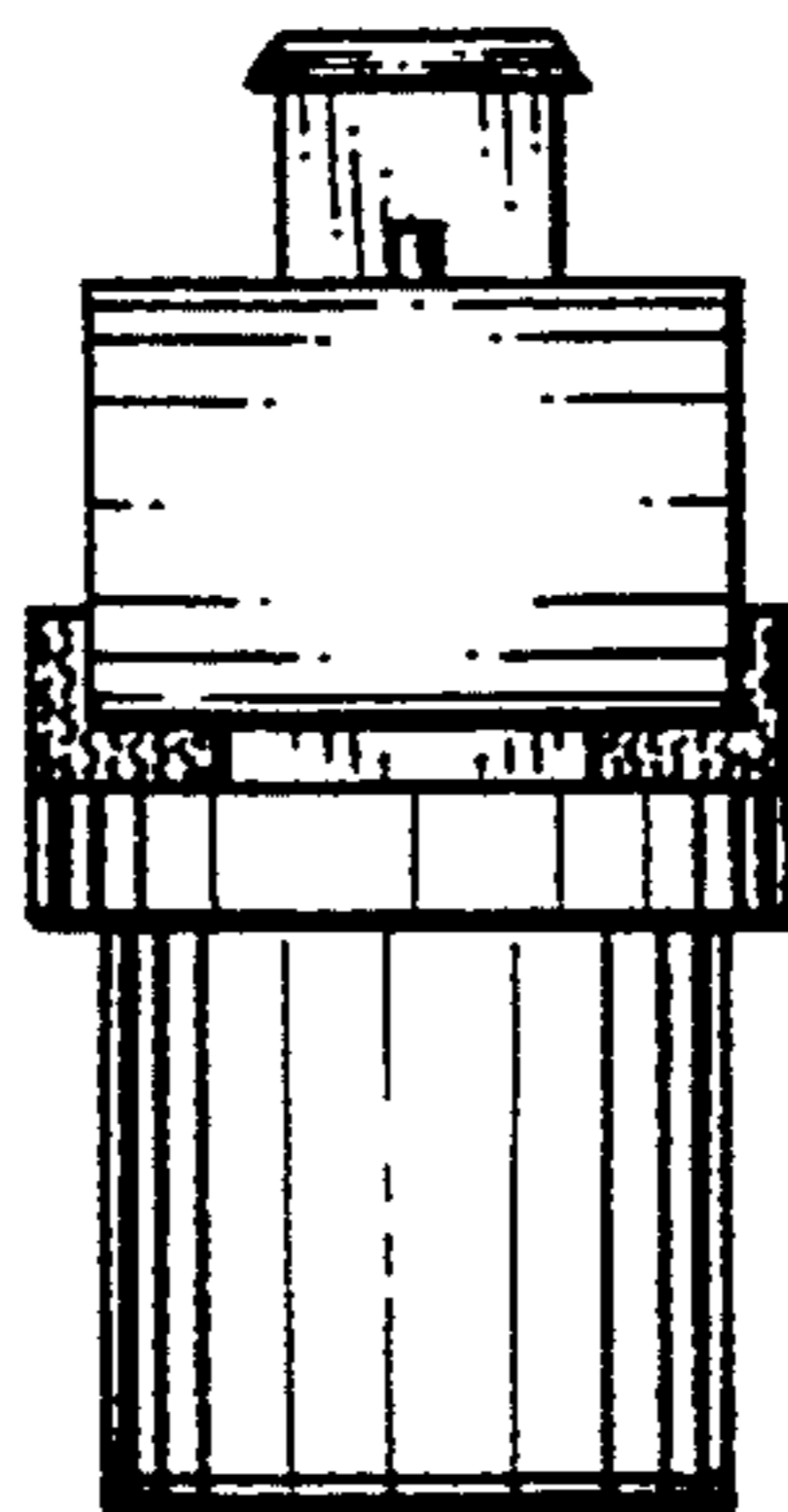

FIG. 29

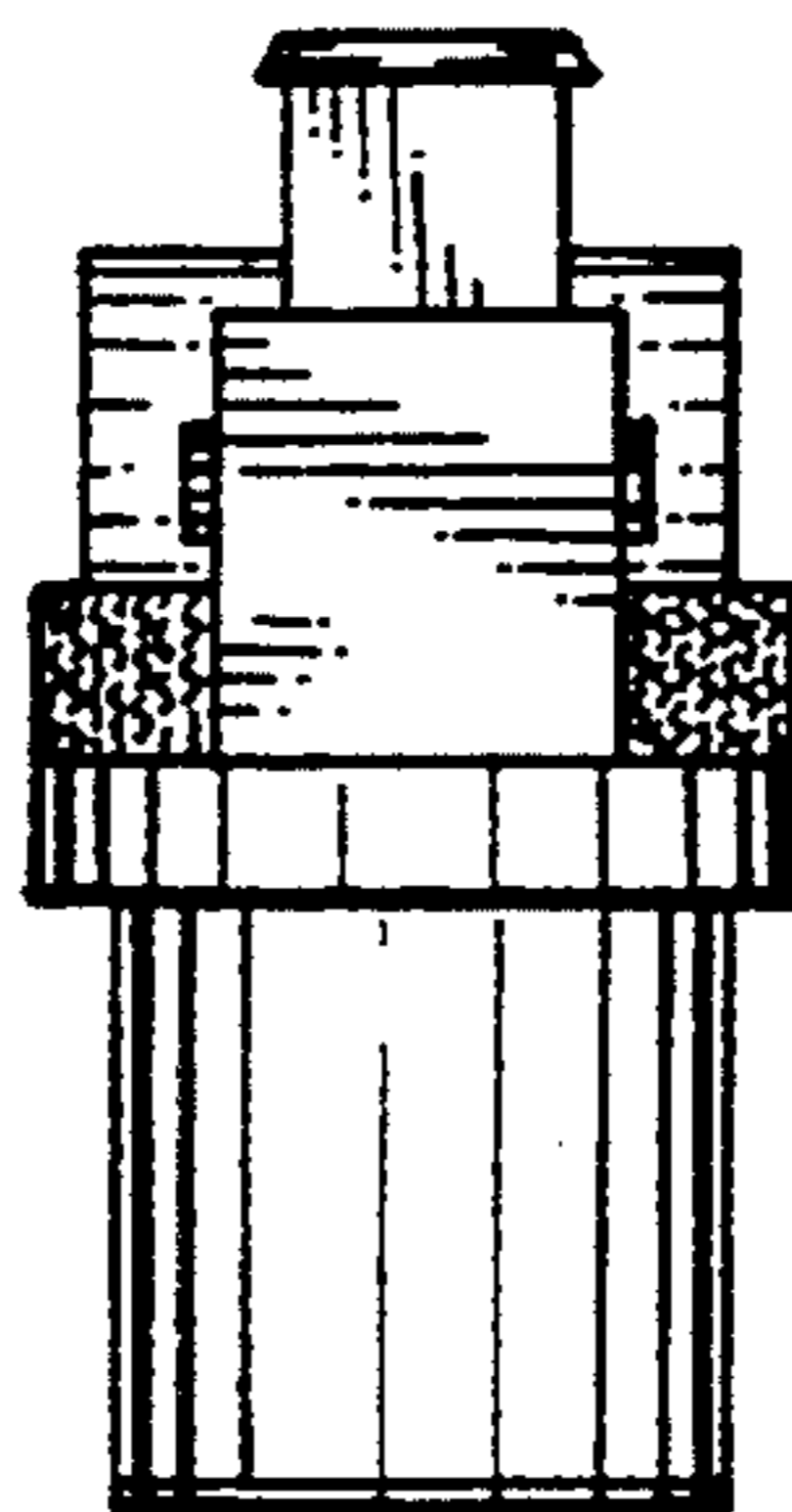

FIG. 30

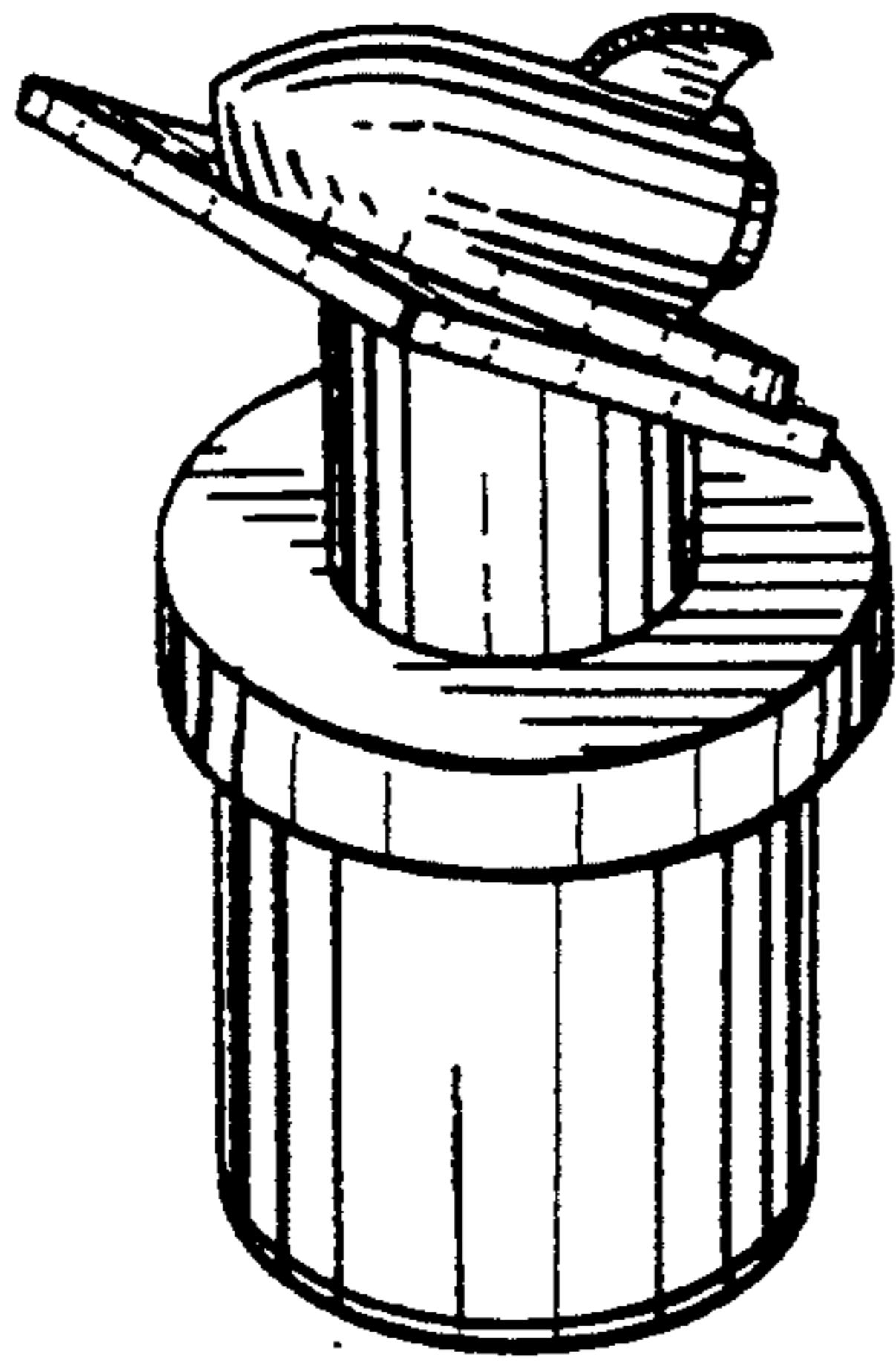

FIG. 31

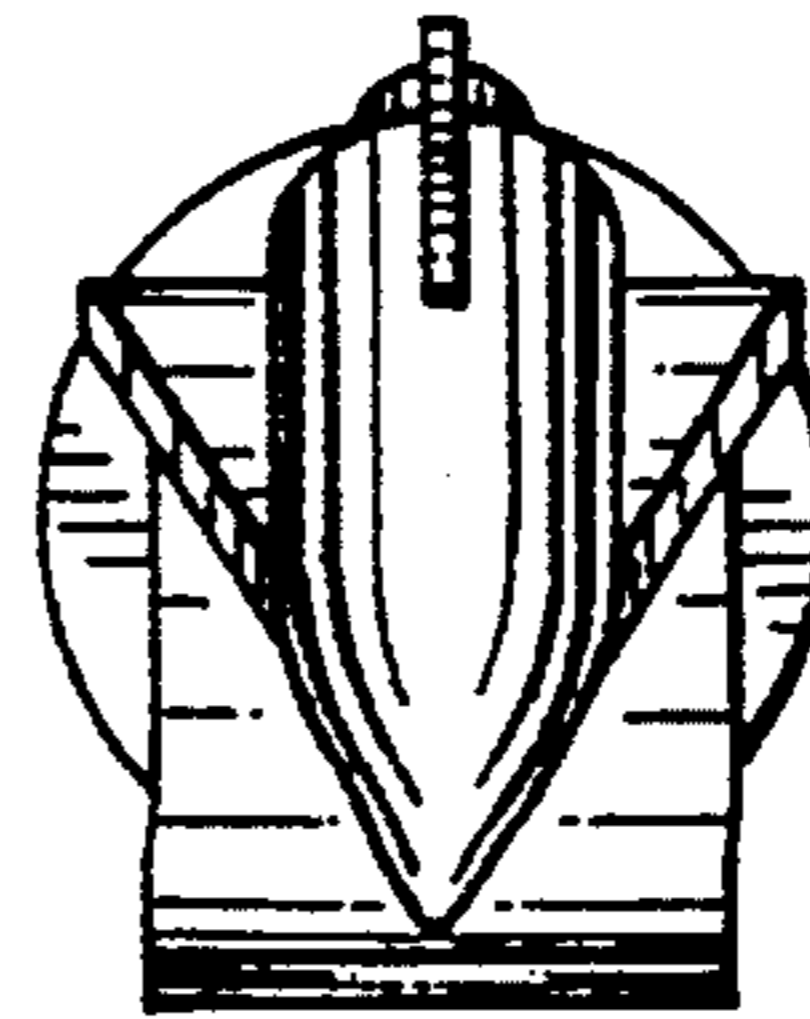

FIG. 32

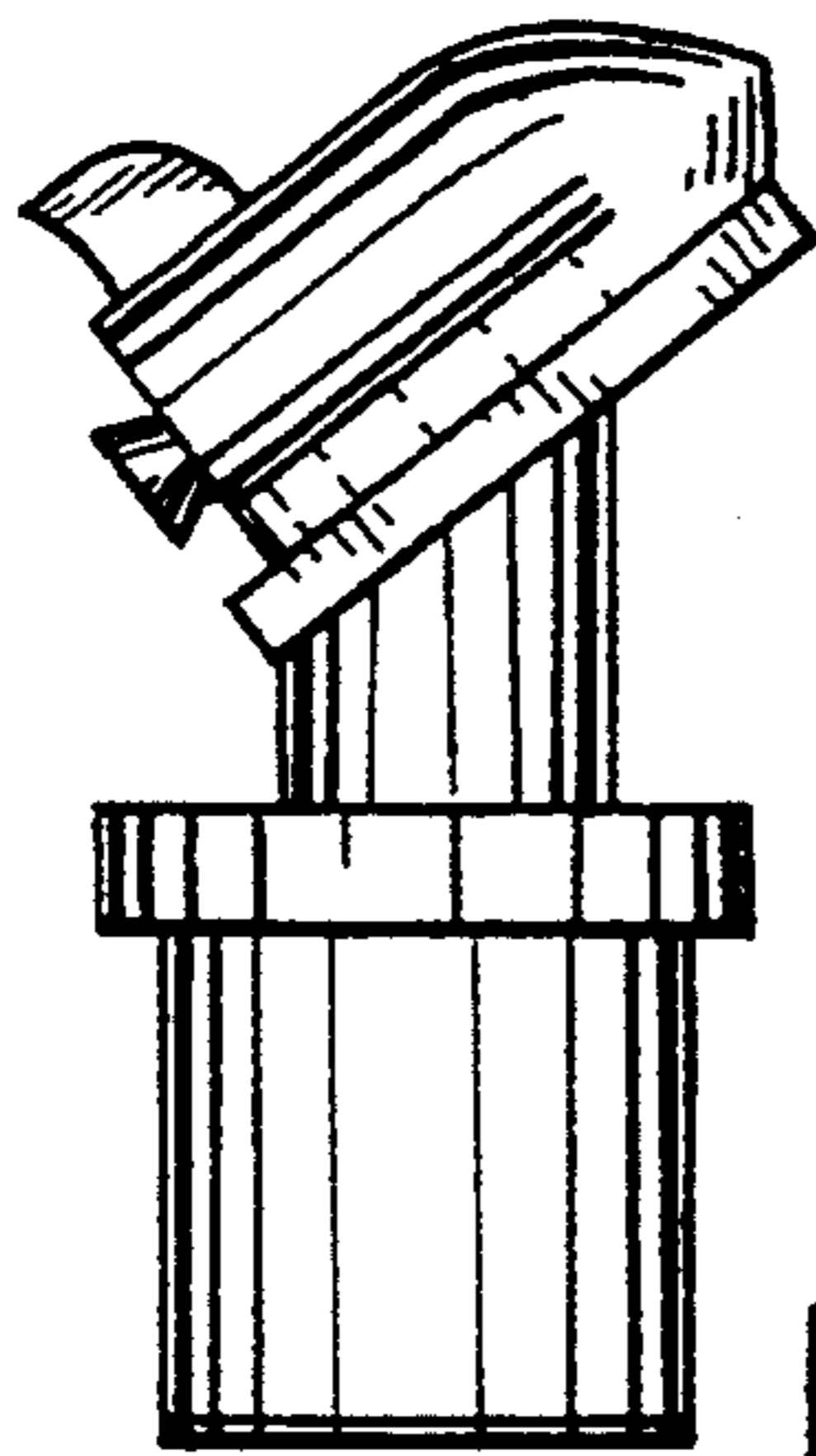

FIG. 33

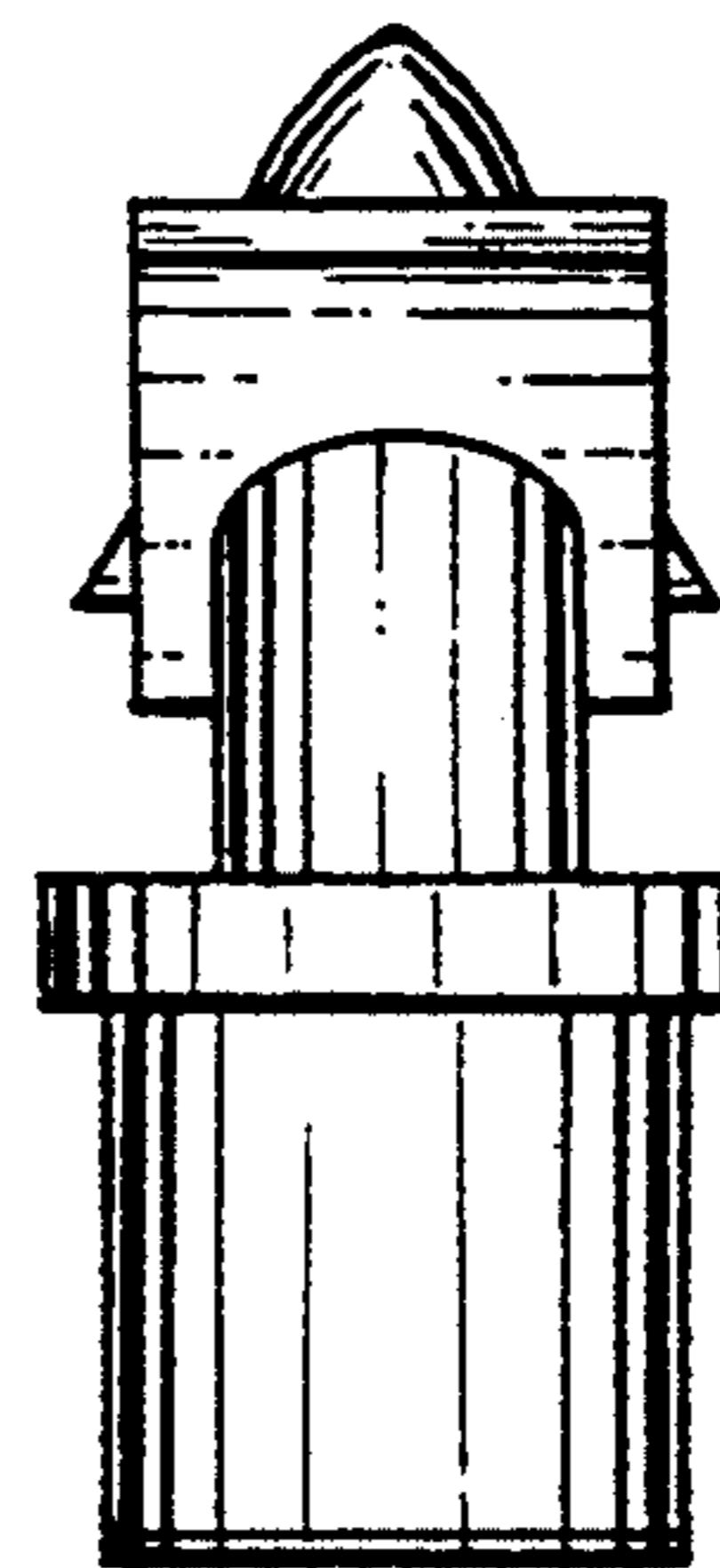

FIG. 34

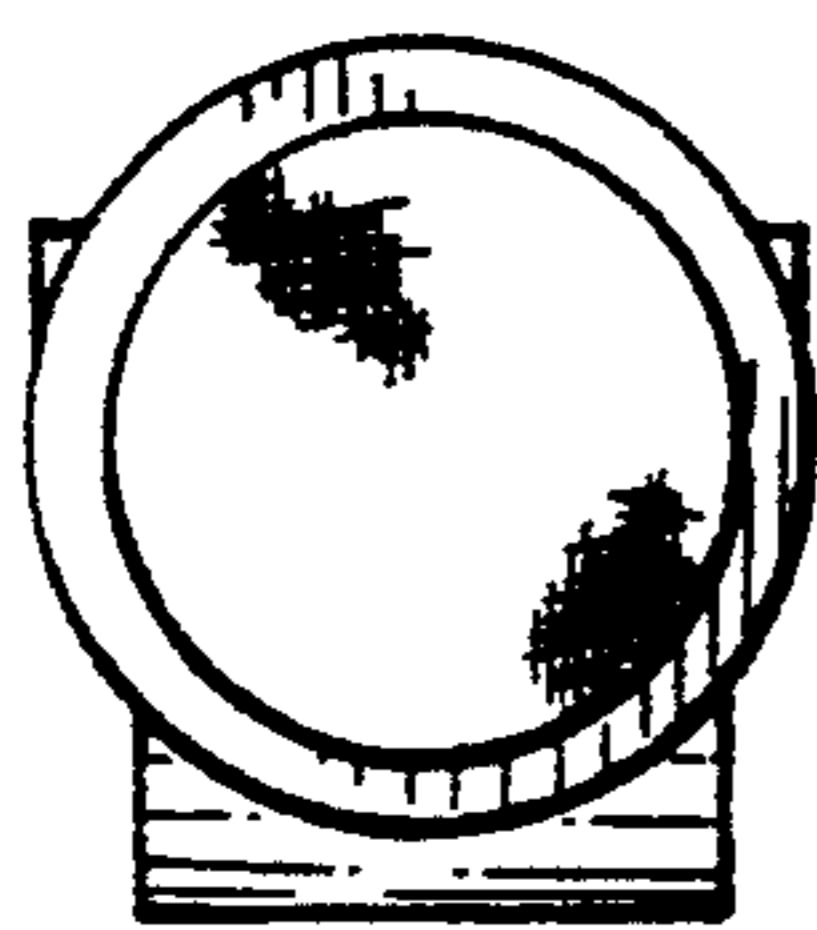

FIG. 35

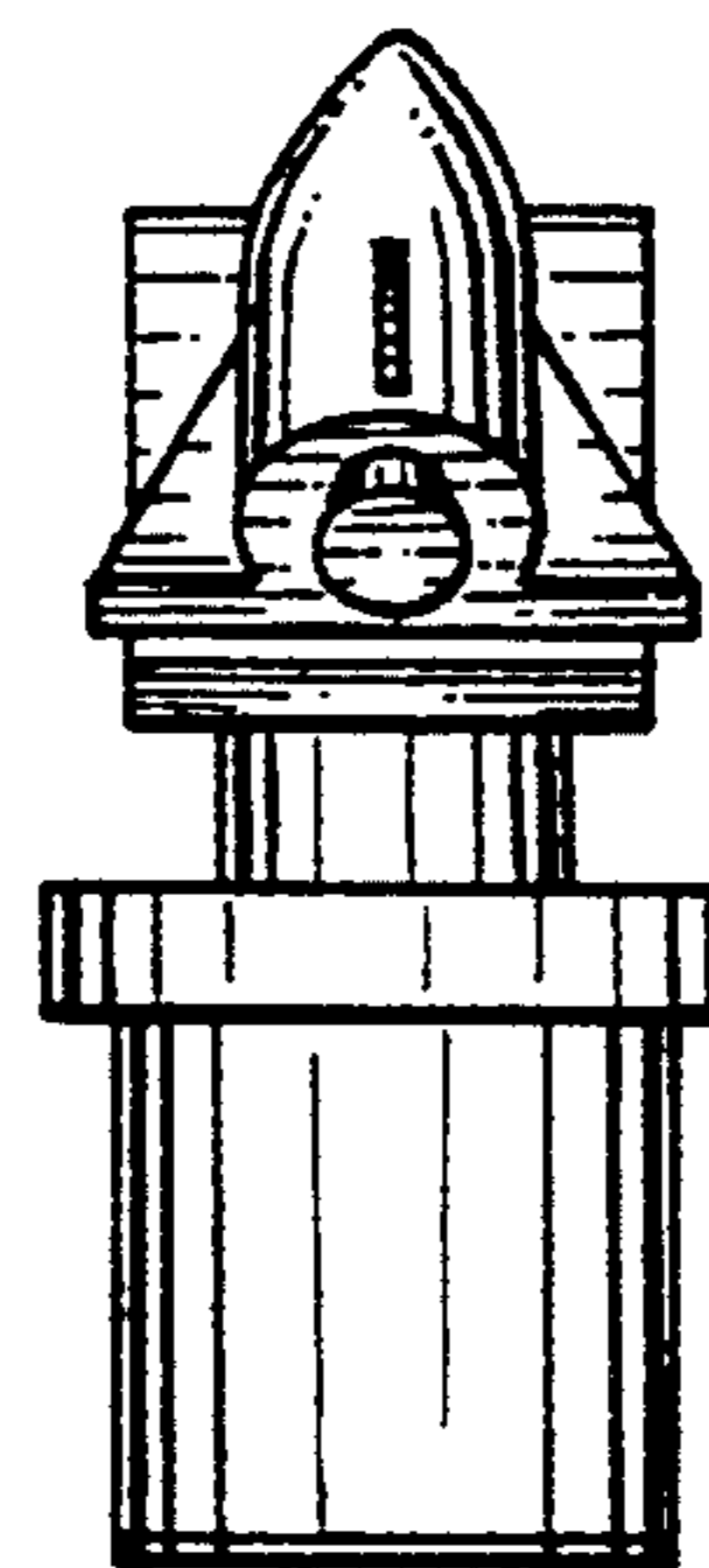

FIG. 36

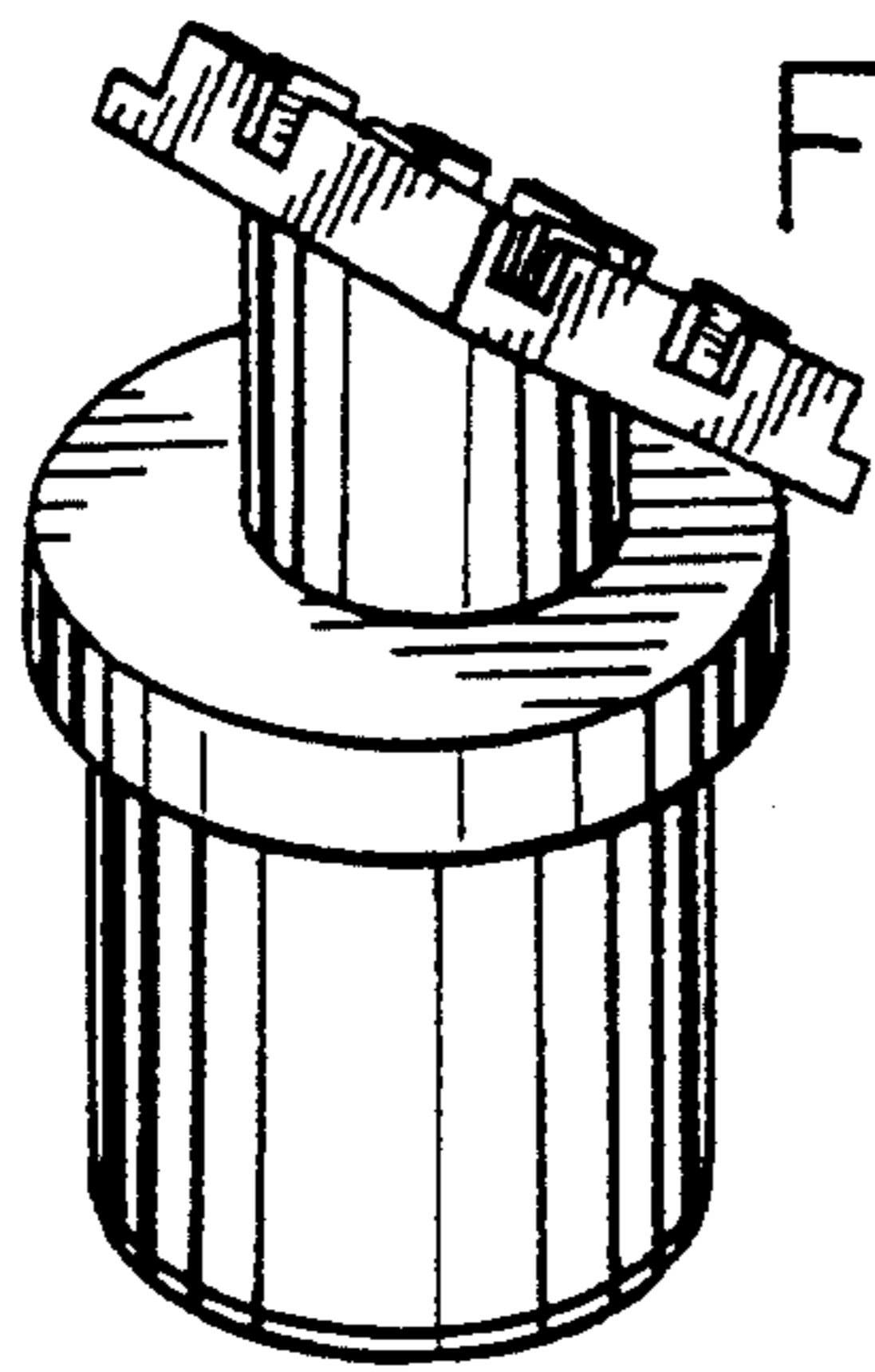

FIG. 37

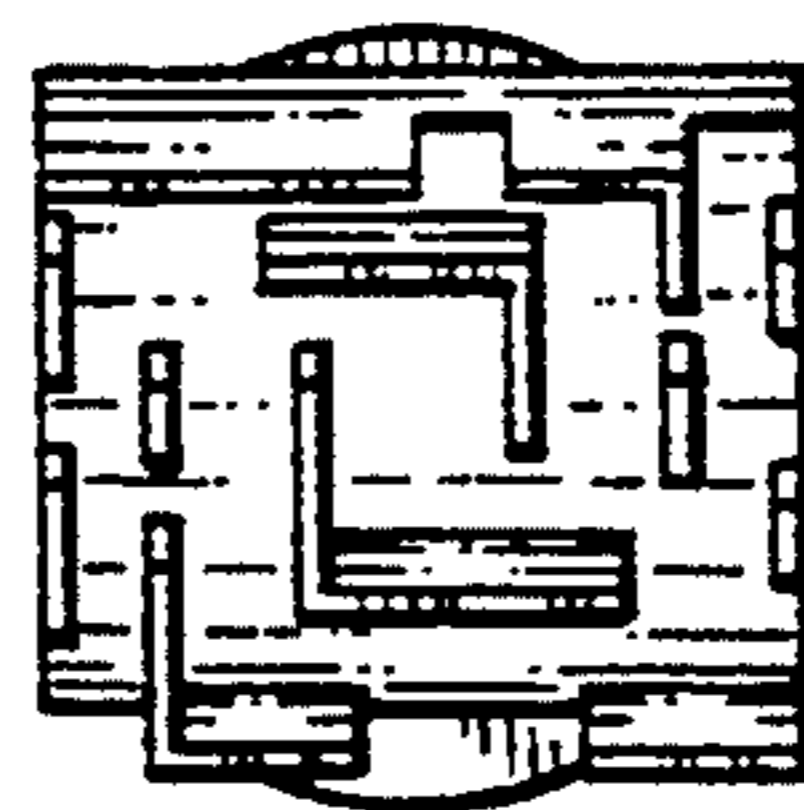

FIG. 38

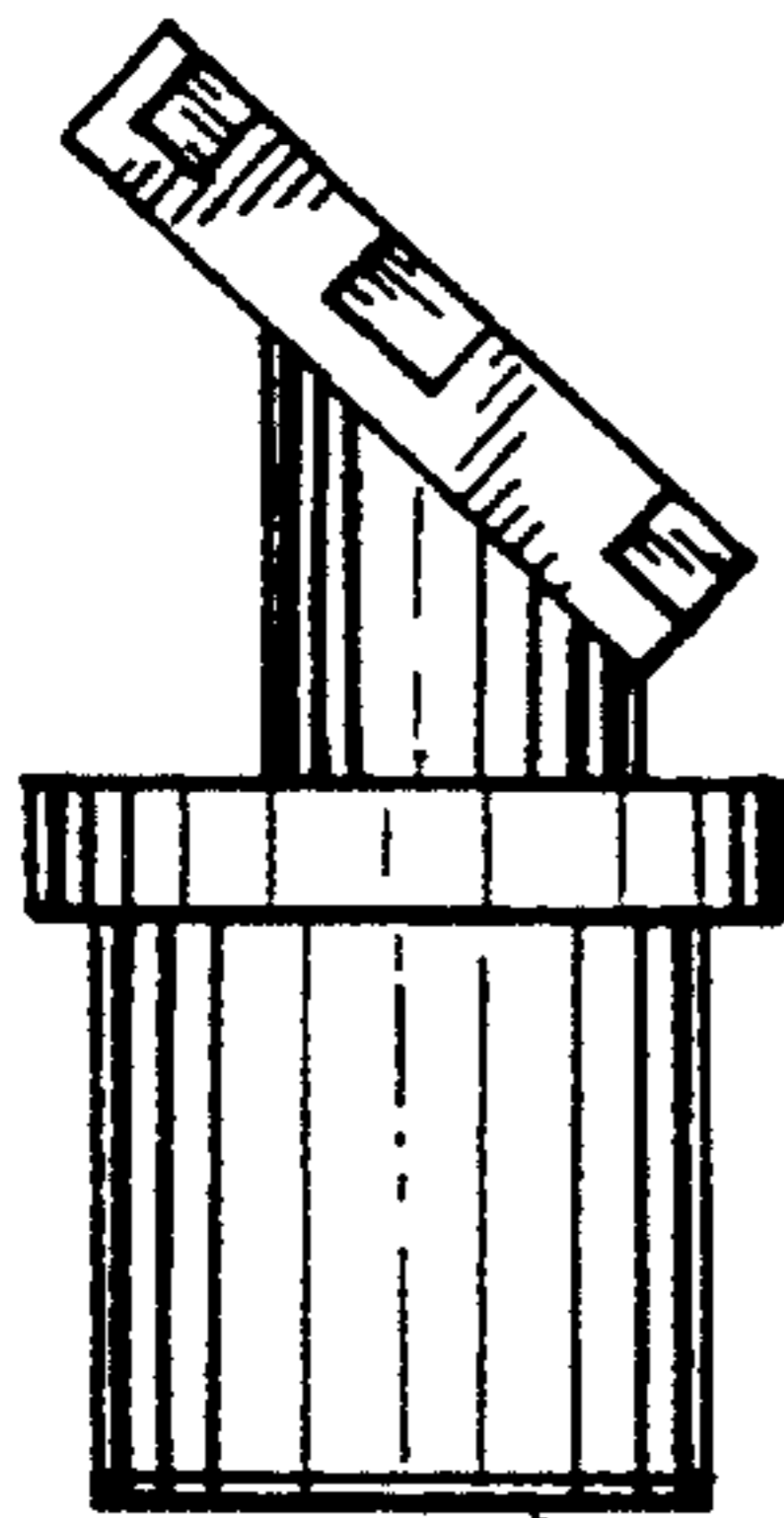

FIG. 39

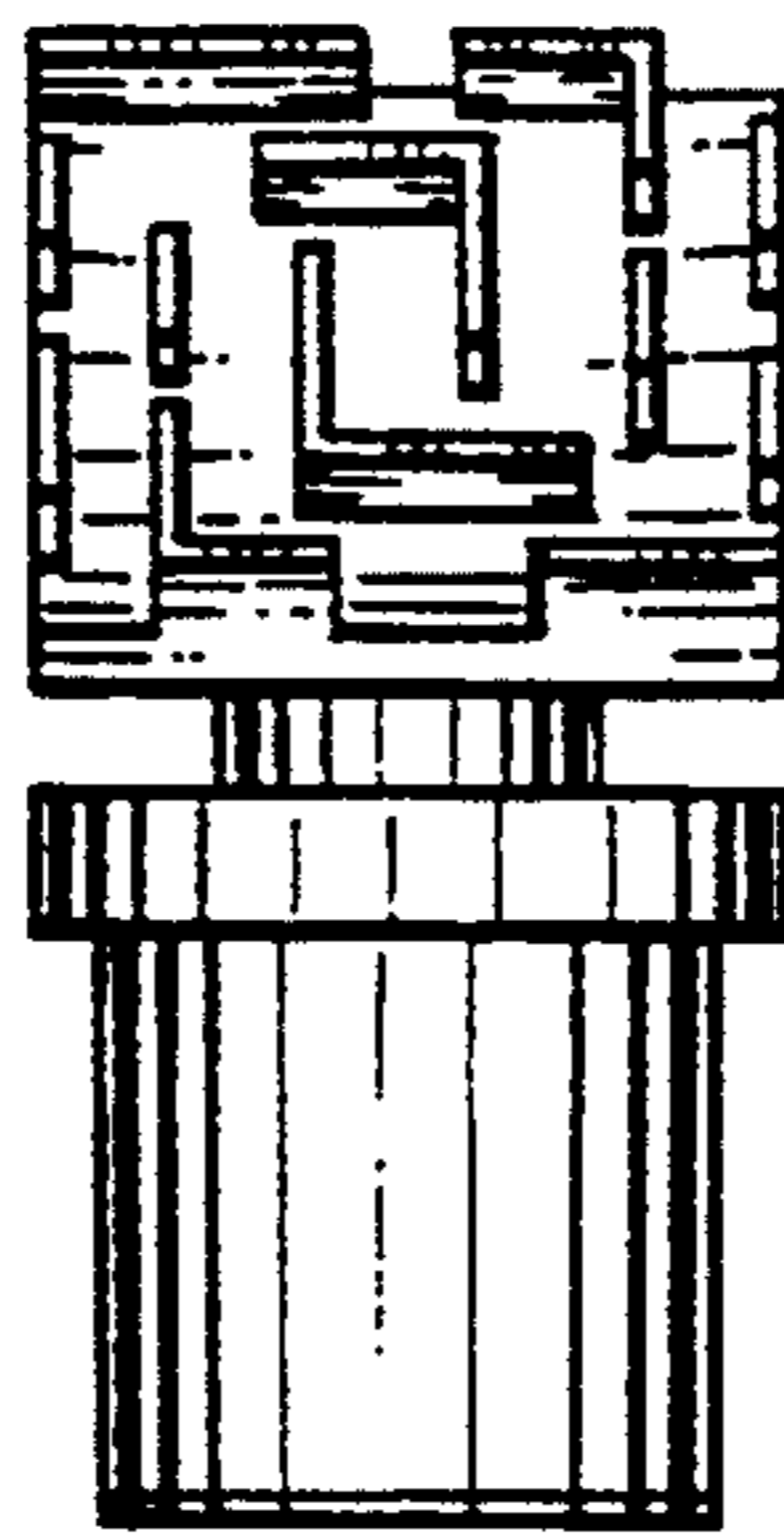

FIG. 40

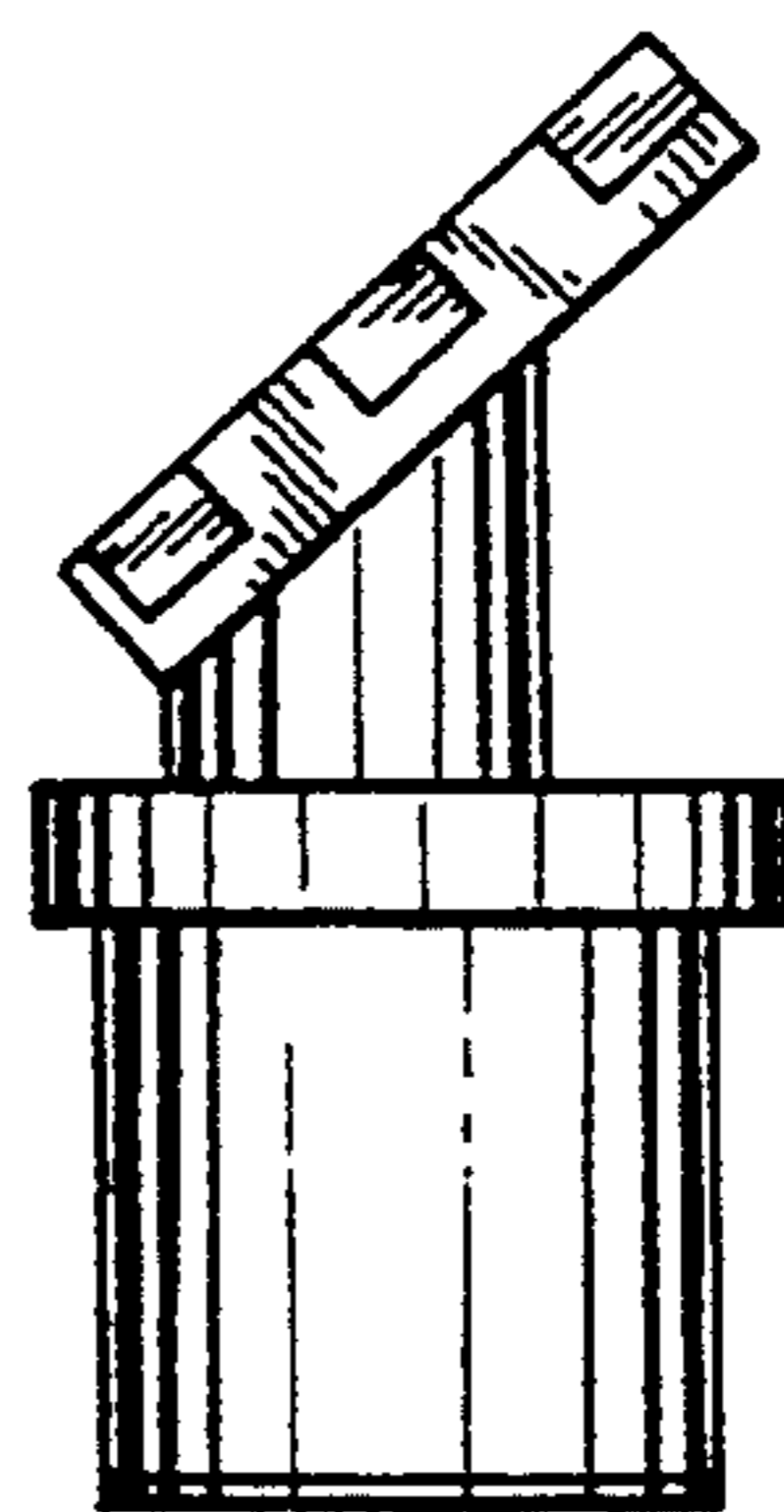

FIG. 41

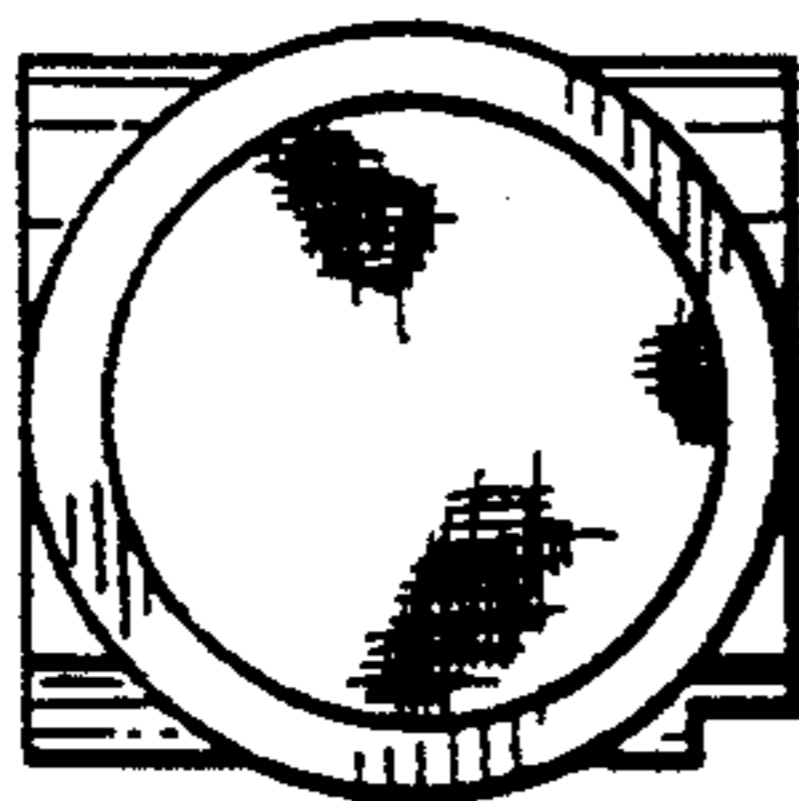

FIG. 42

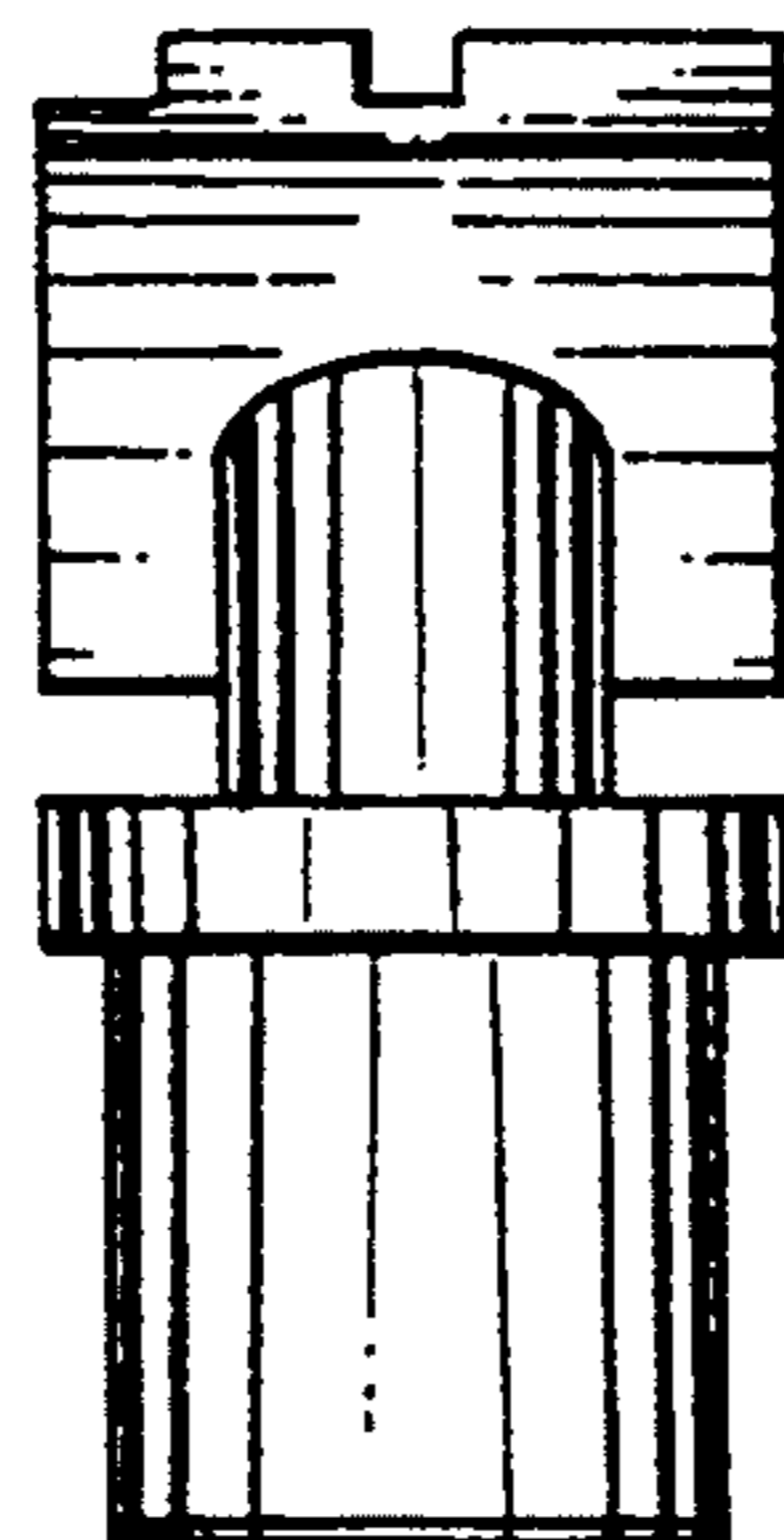

FIG. 43

FIG. 44

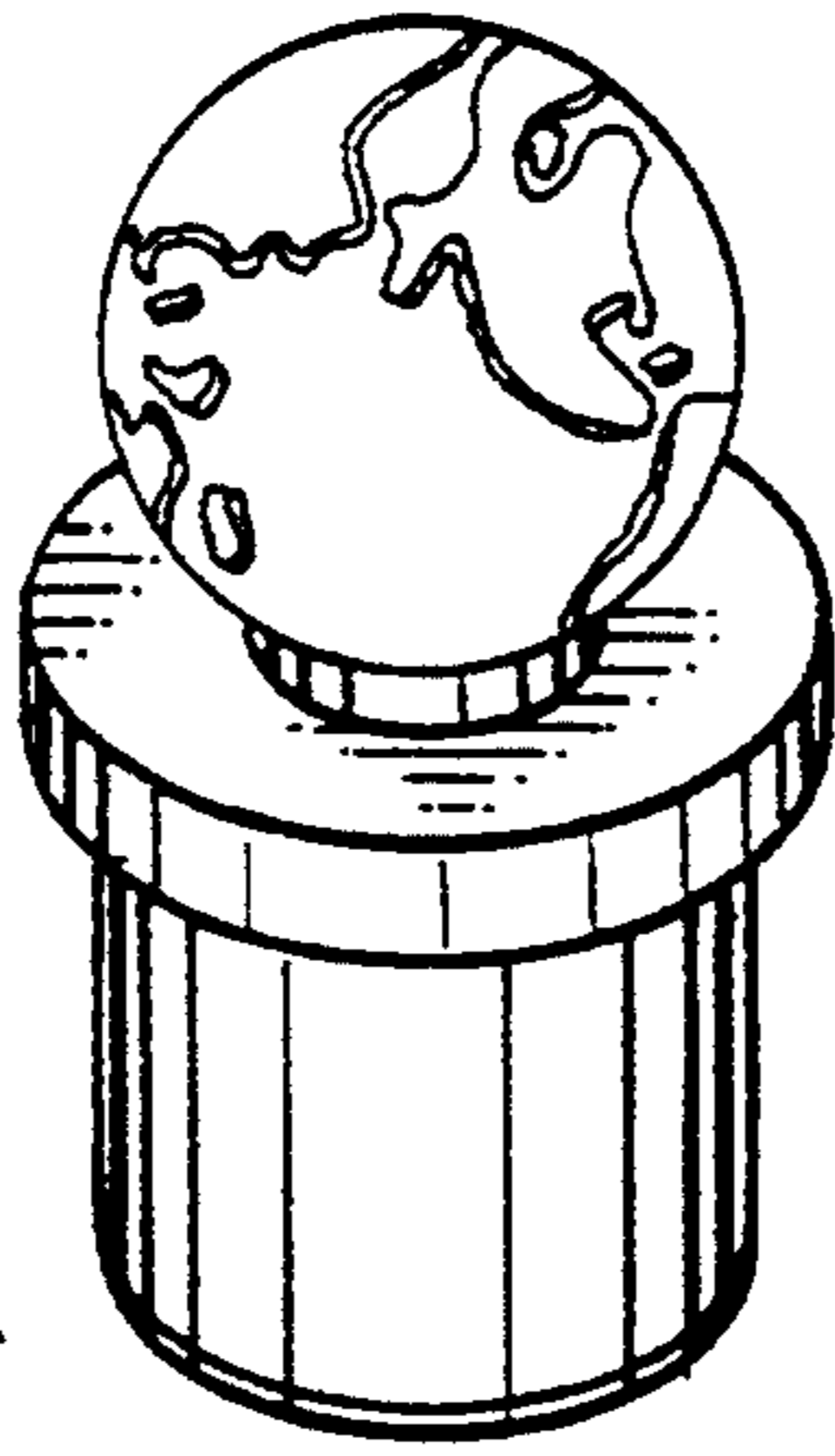

FIG. 45

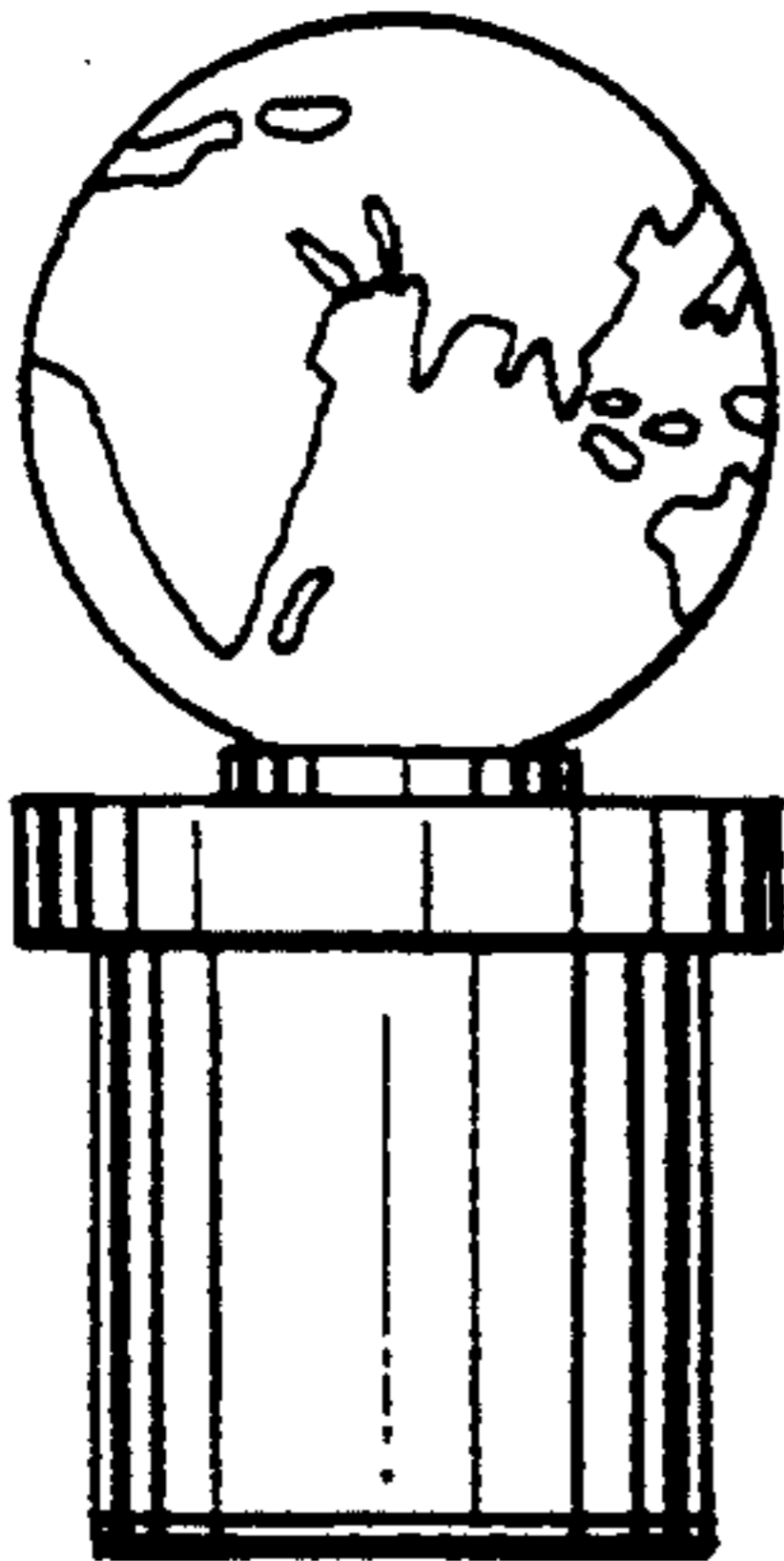

FIG. 46

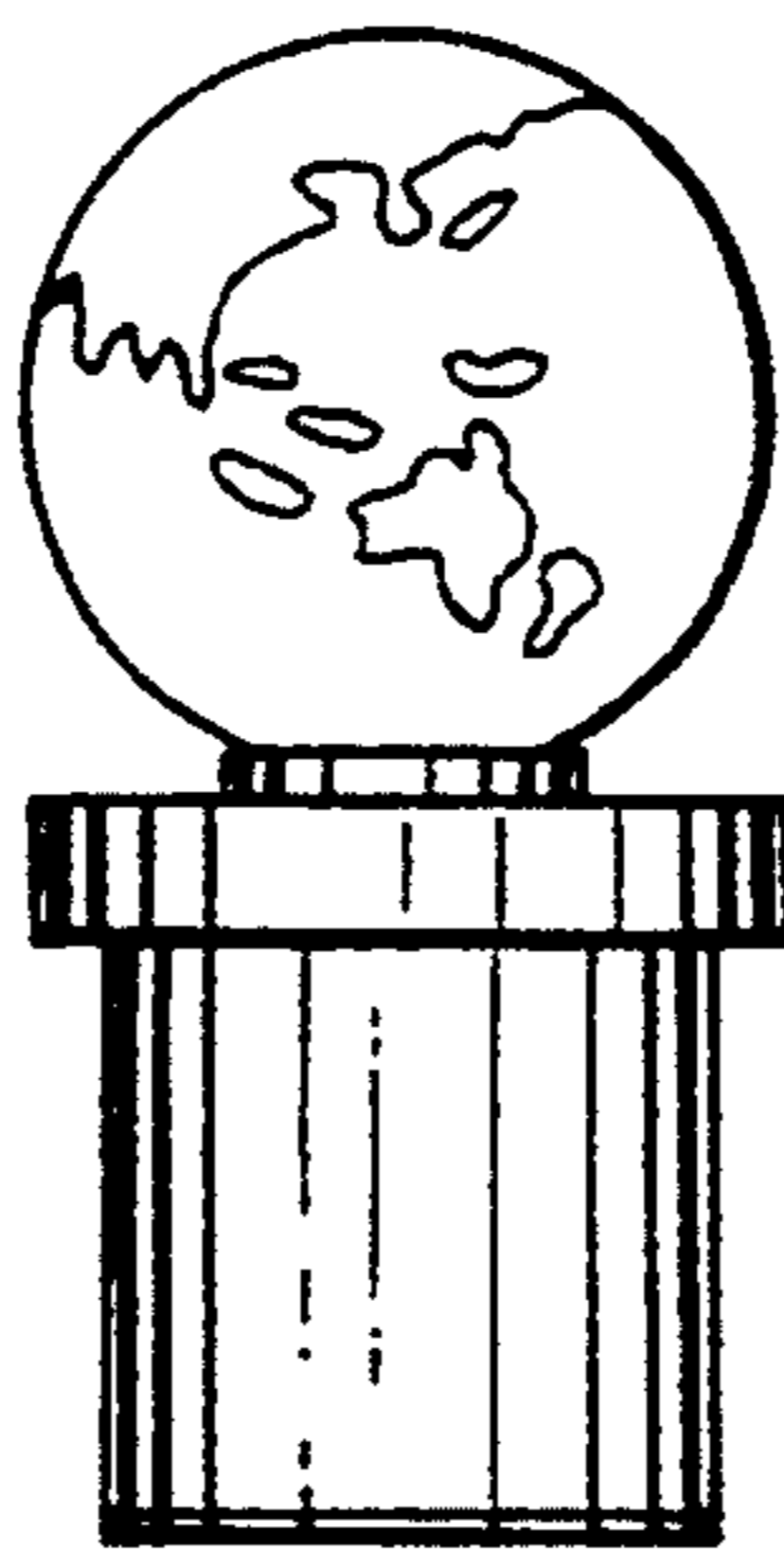

FIG. 47



FIG. 48

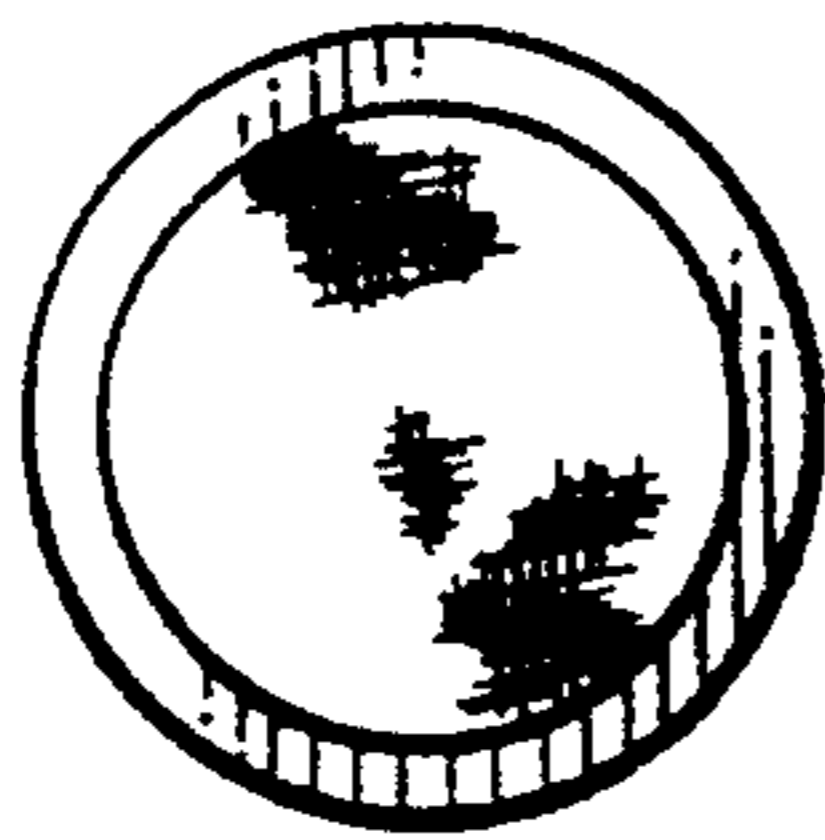

FIG. 49

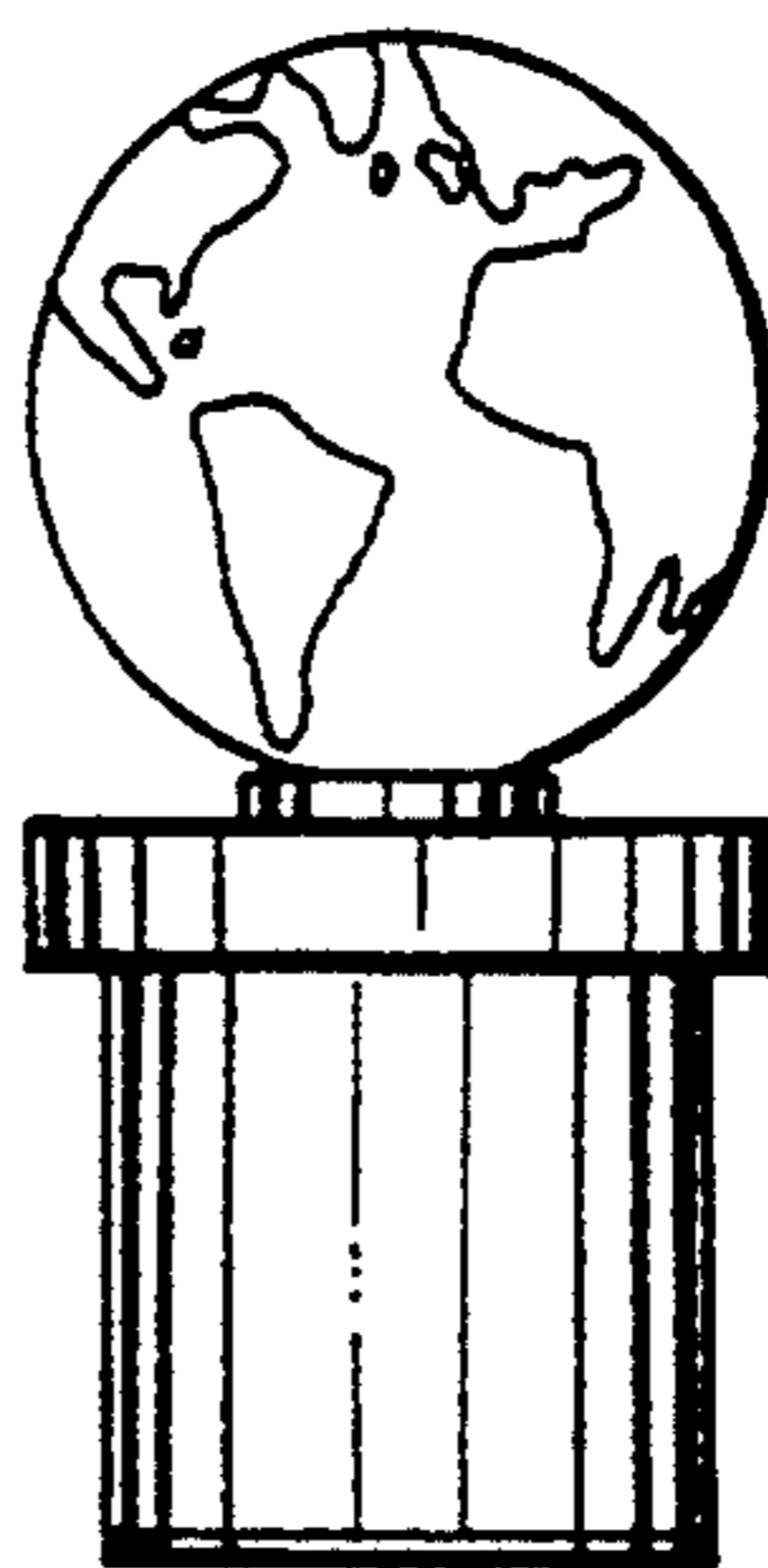

FIG. 50

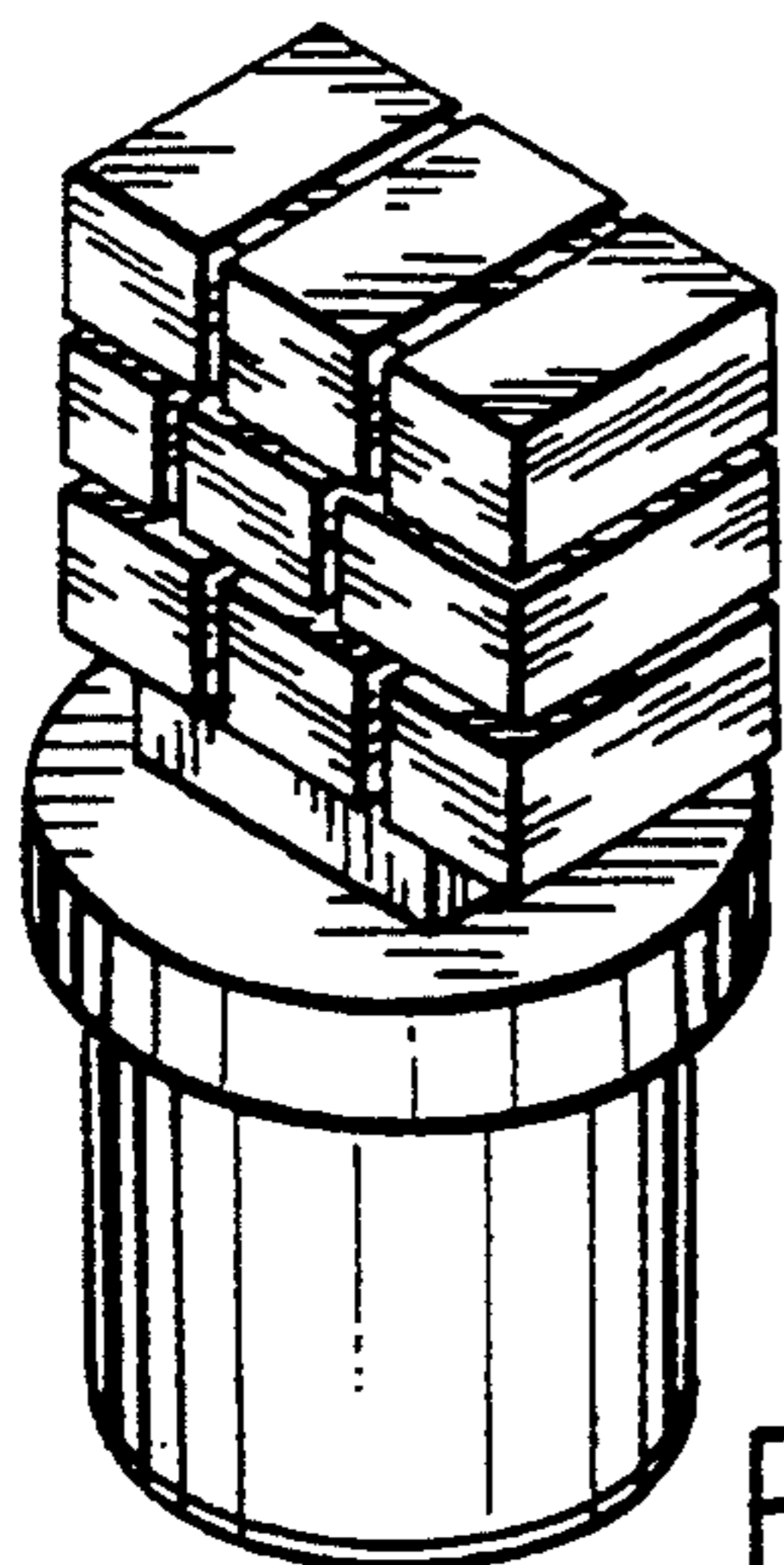

FIG. 51

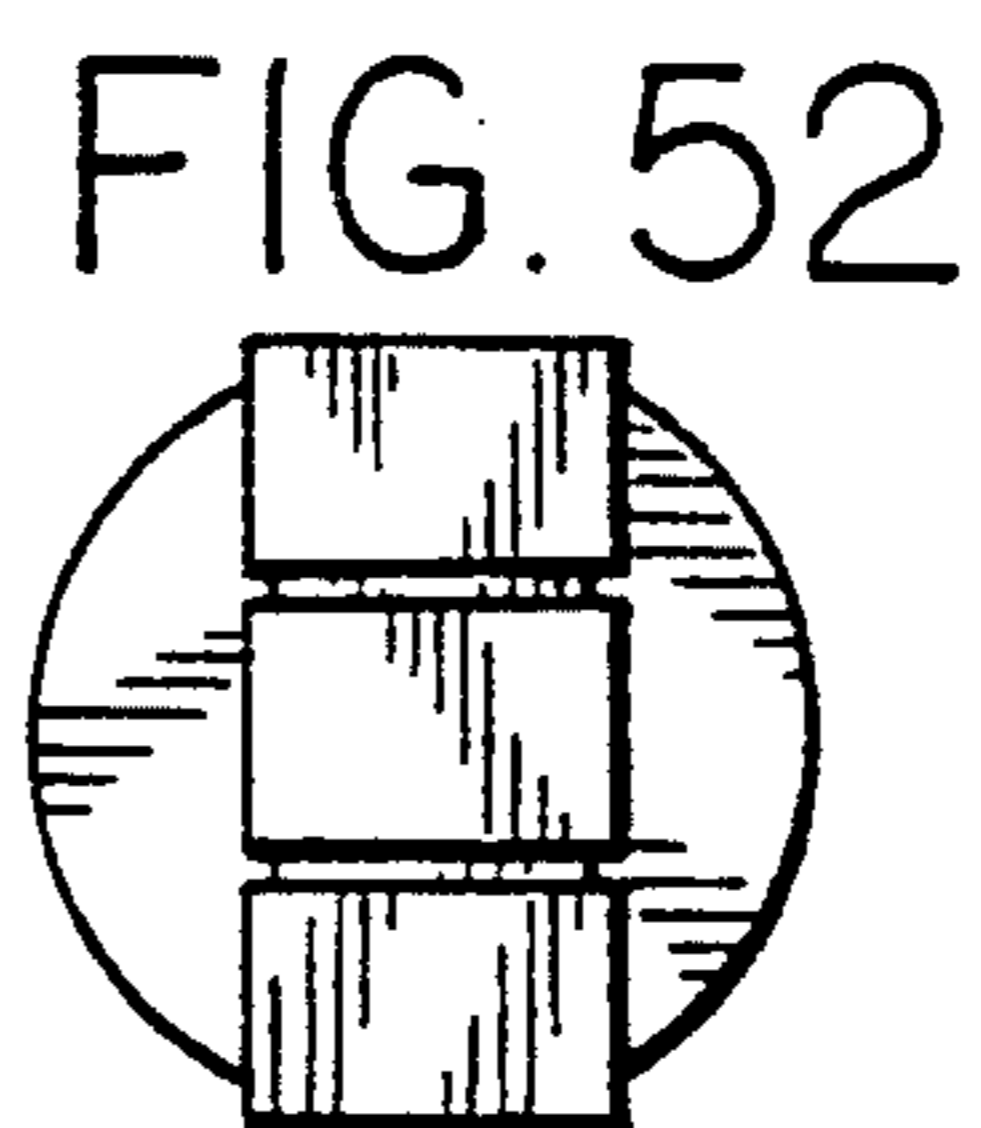

FIG. 52

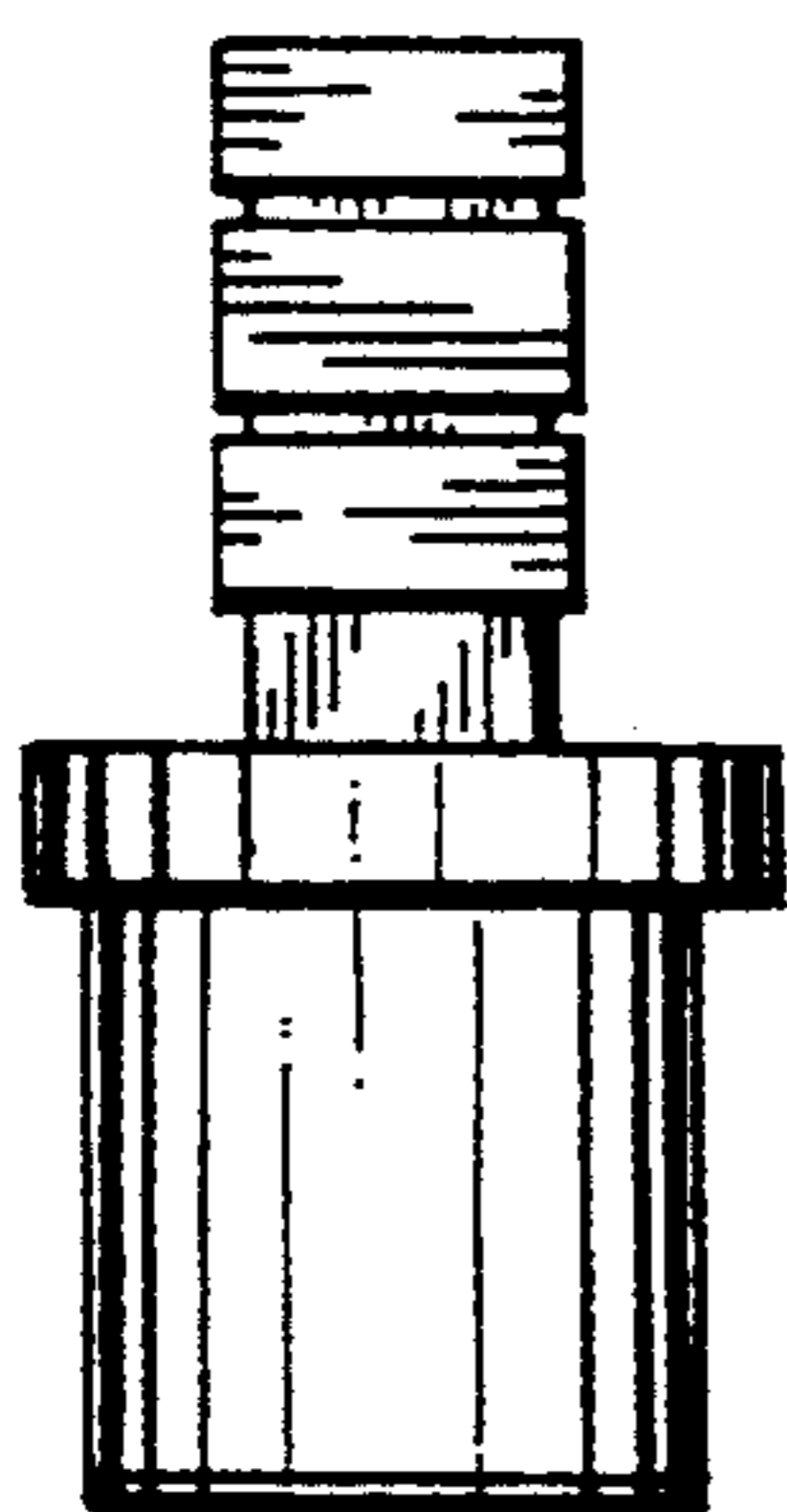

FIG. 53

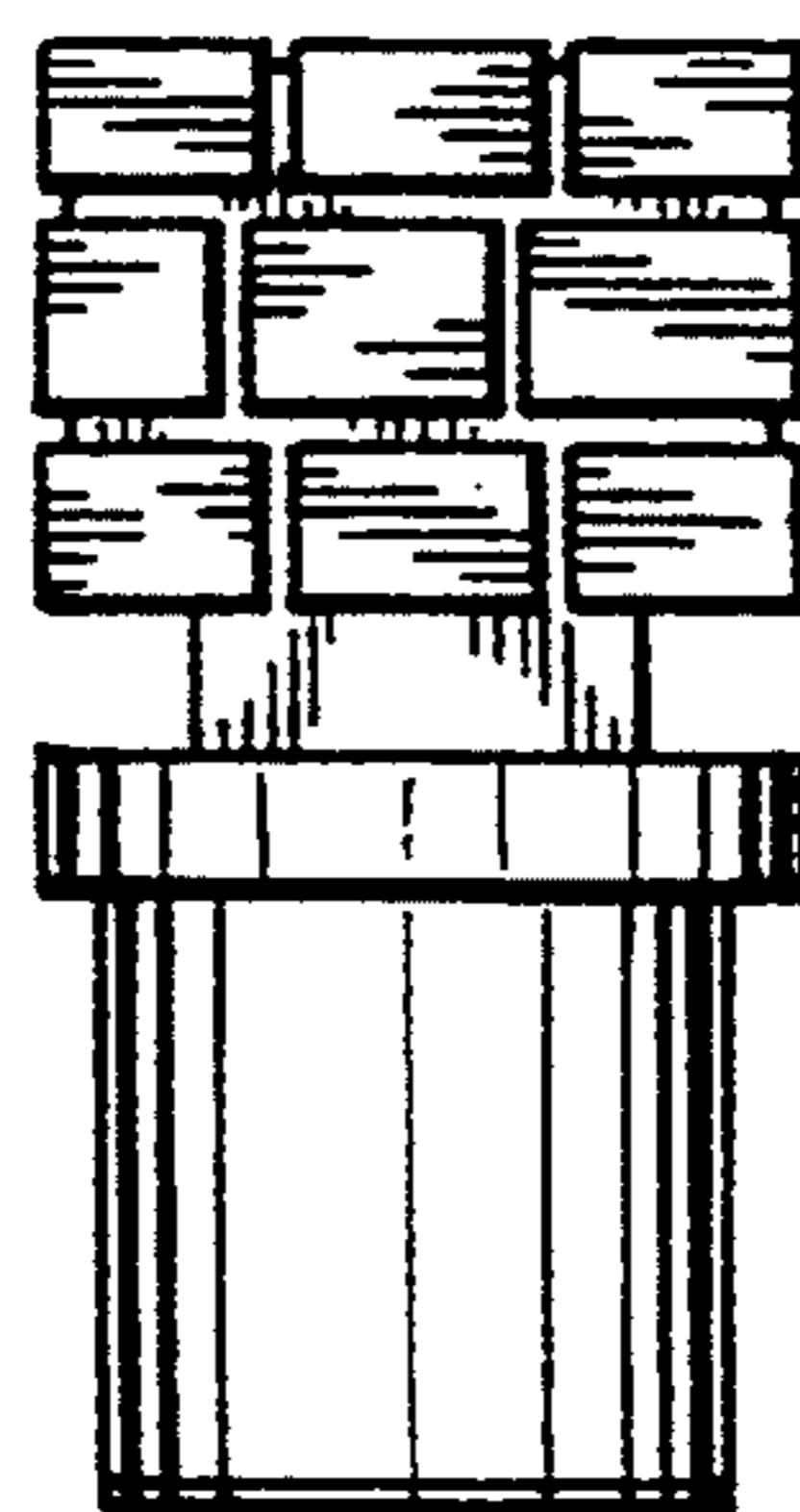

FIG. 54

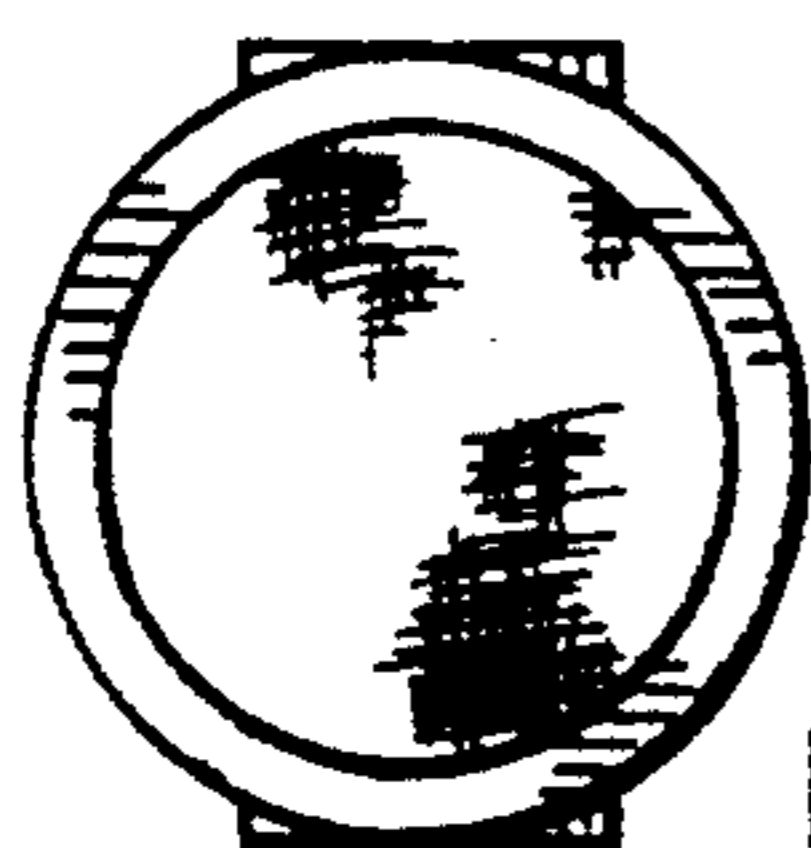

FIG. 55

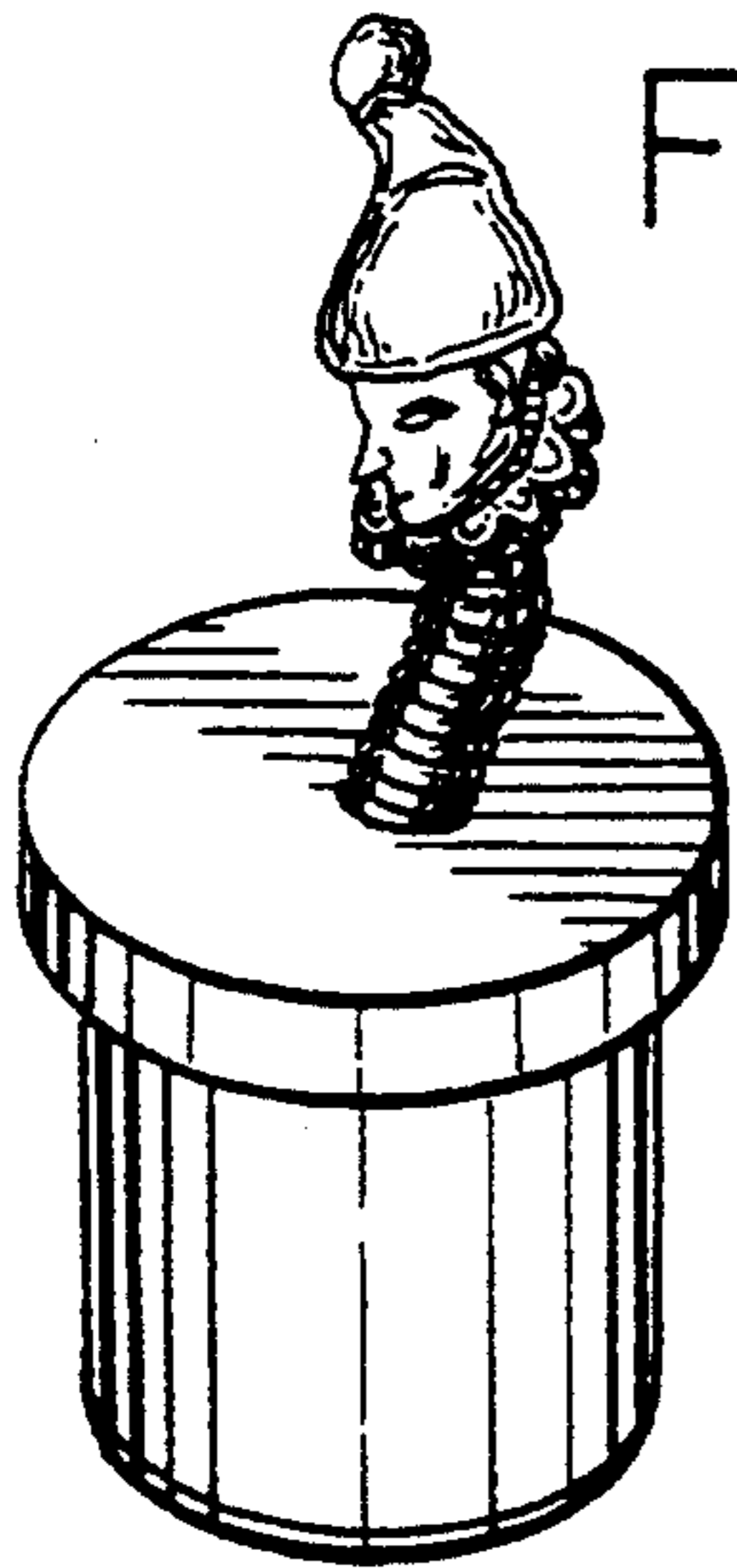

FIG. 56

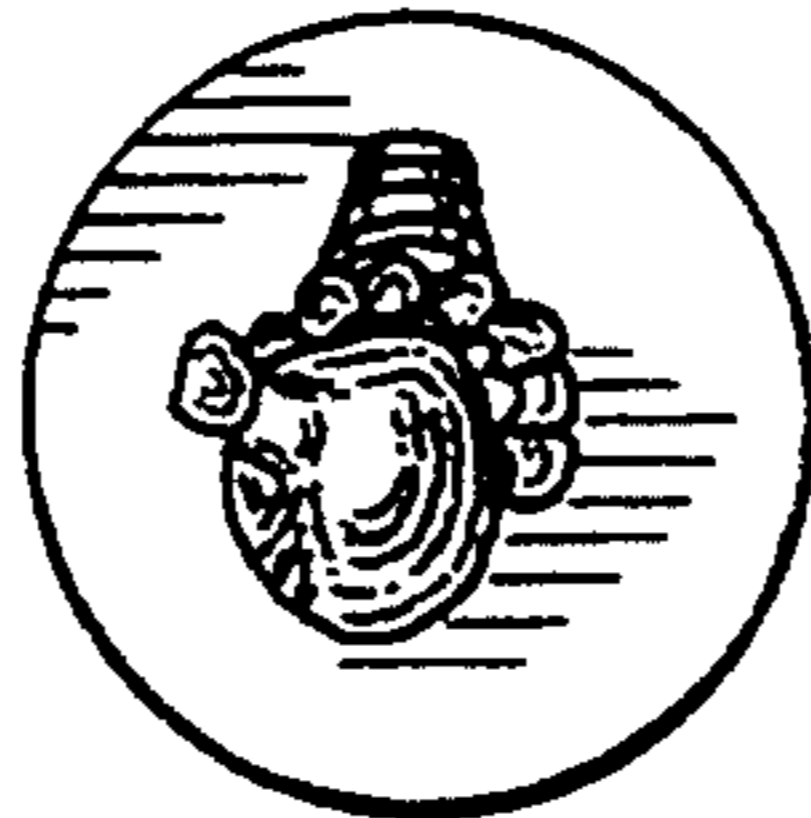

FIG. 57

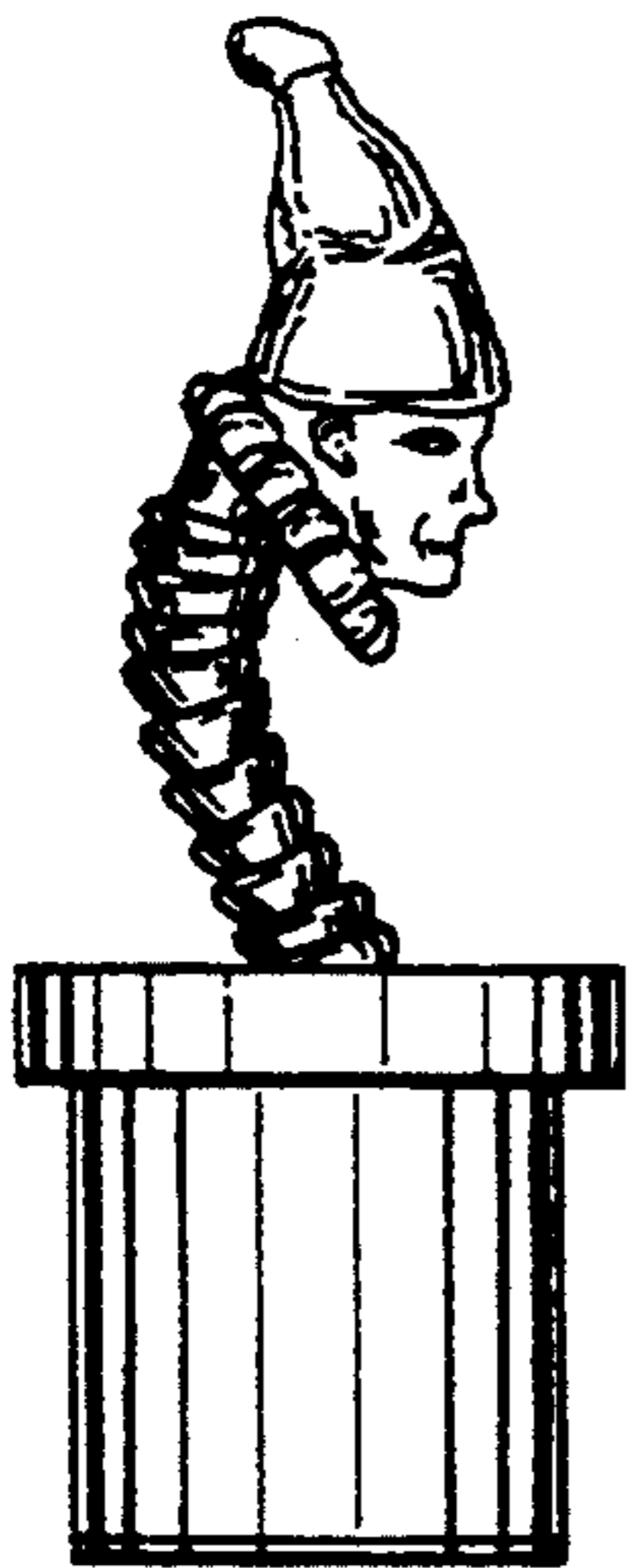

FIG. 58

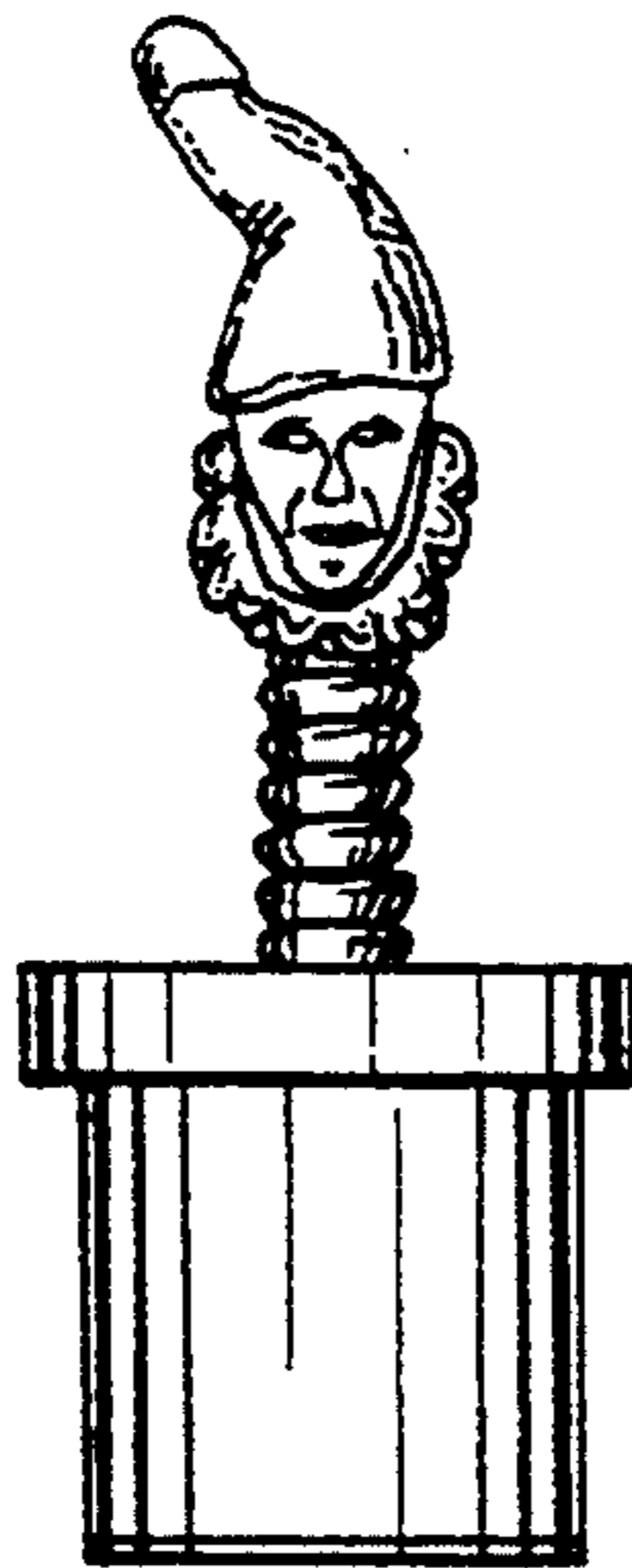

FIG. 59

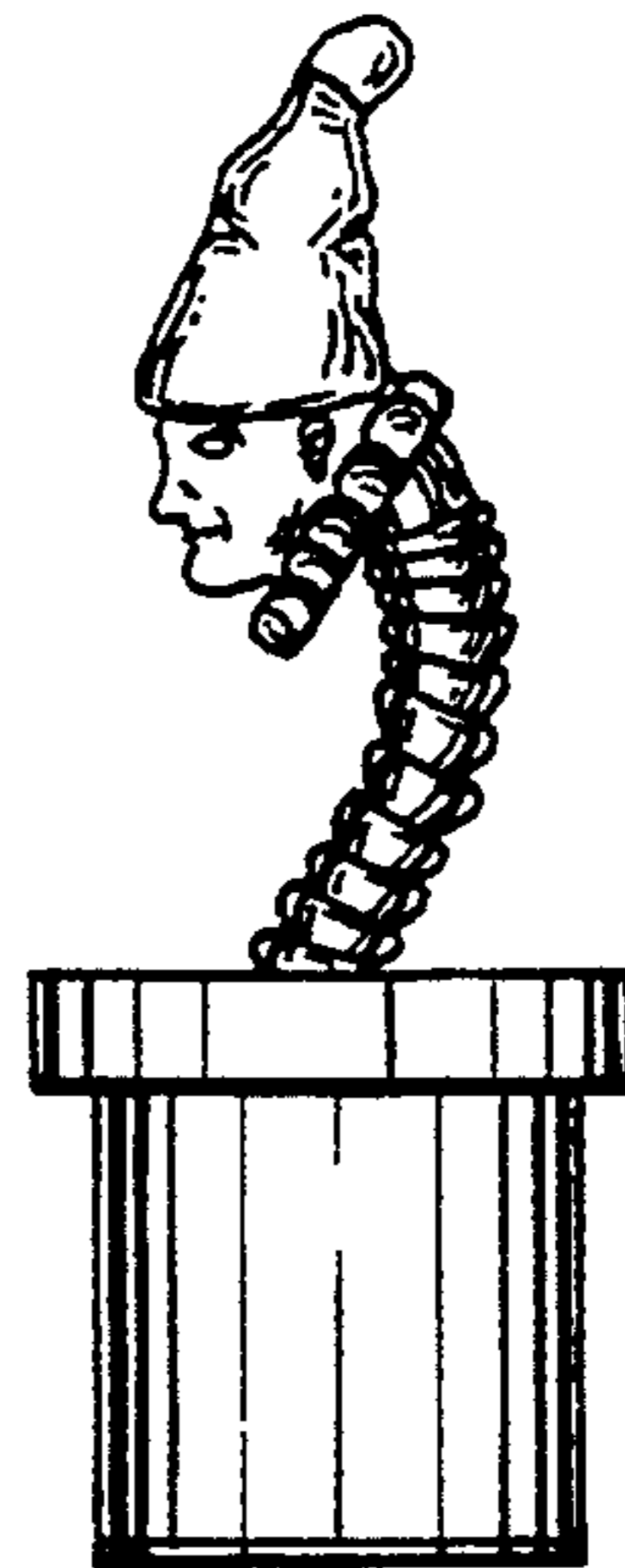

FIG. 60

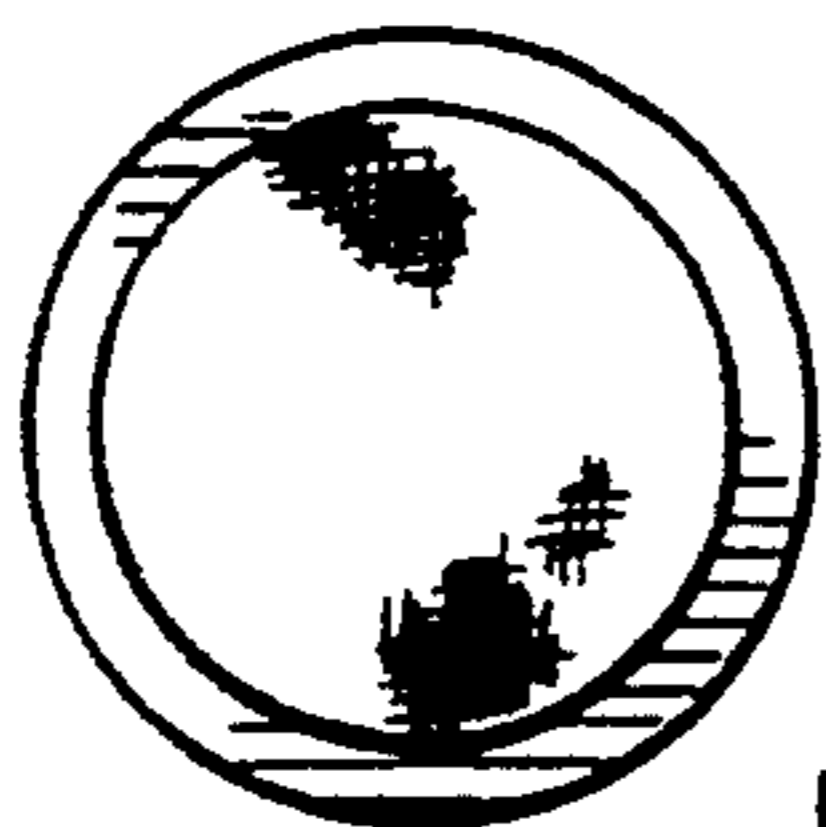

FIG. 61

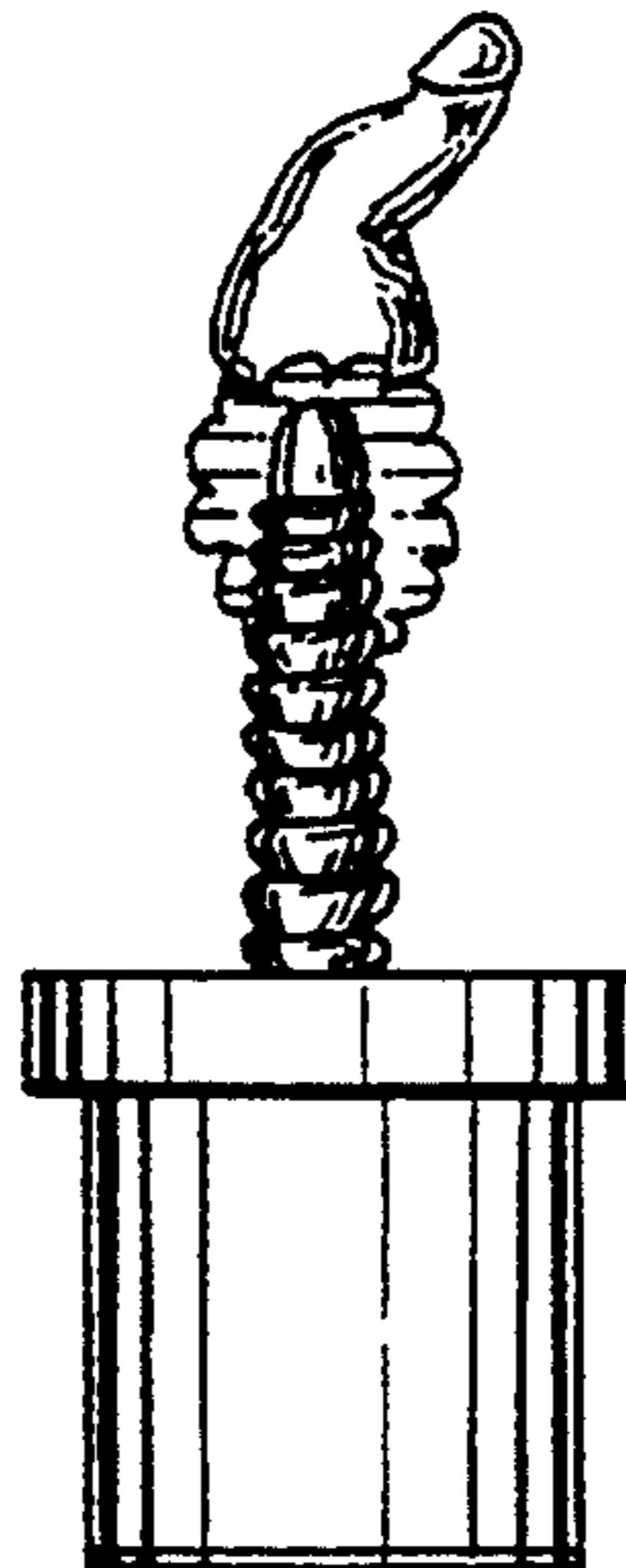

FIG. 62

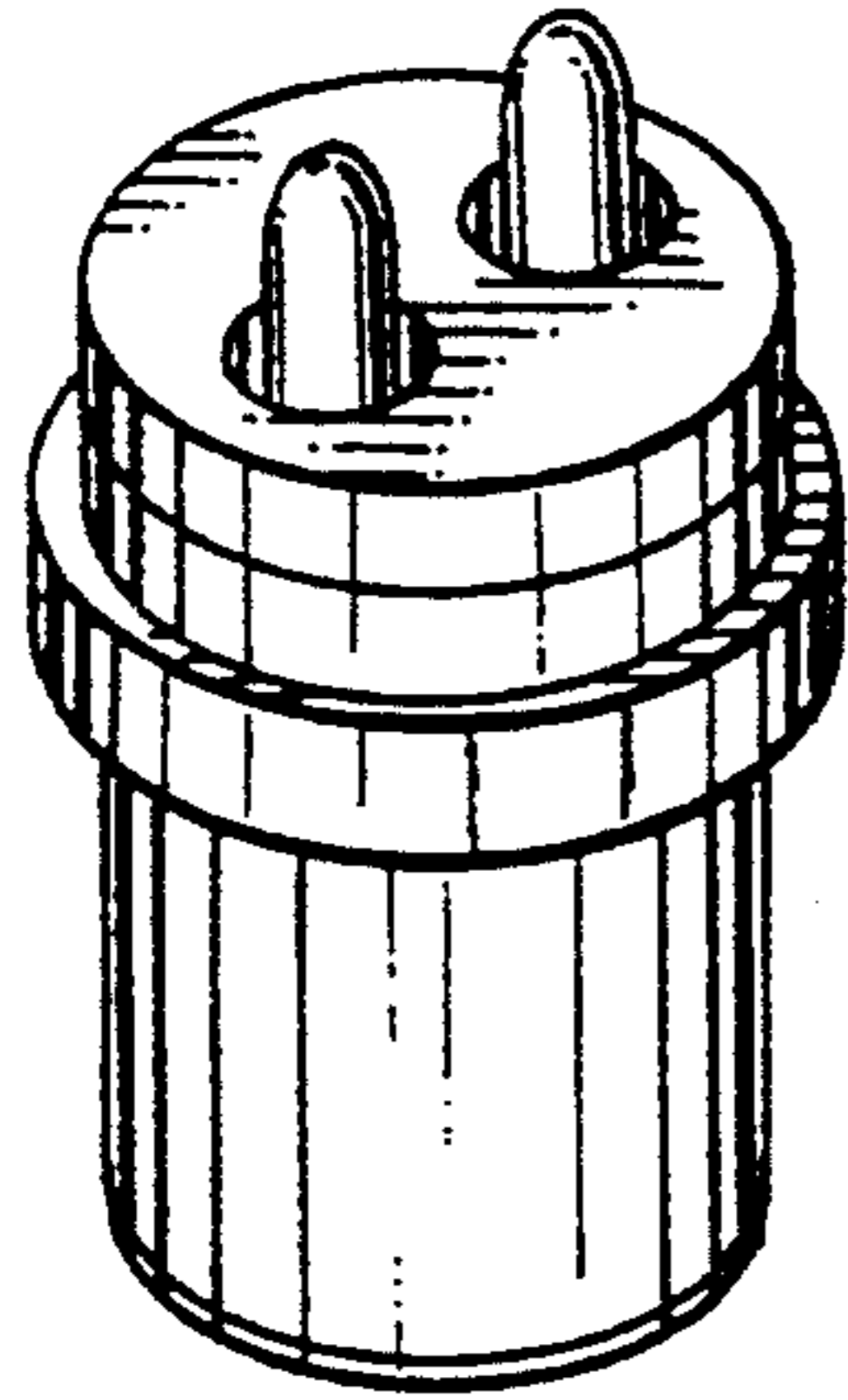

FIG. 63

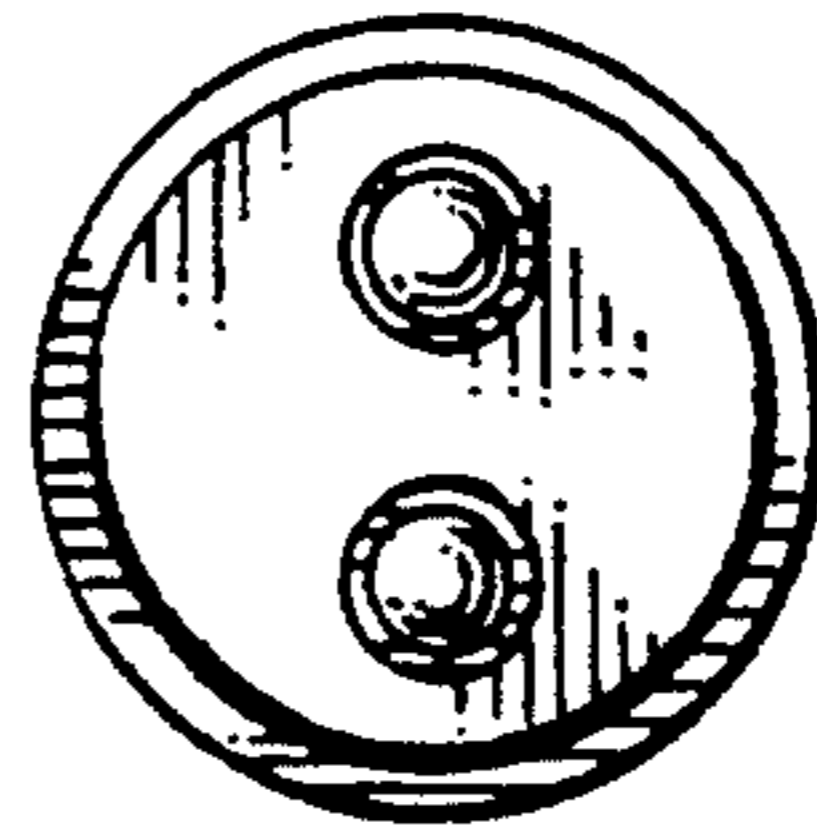

FIG. 64

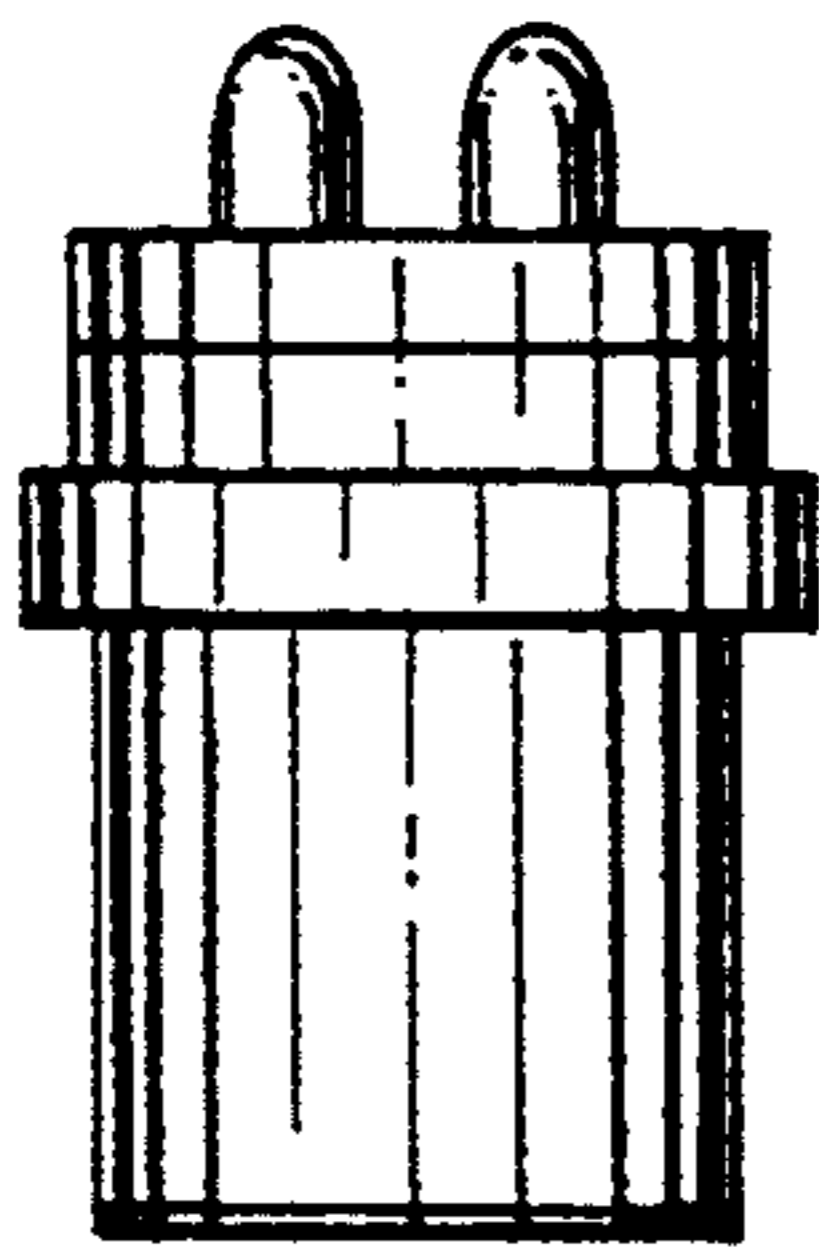

FIG. 65

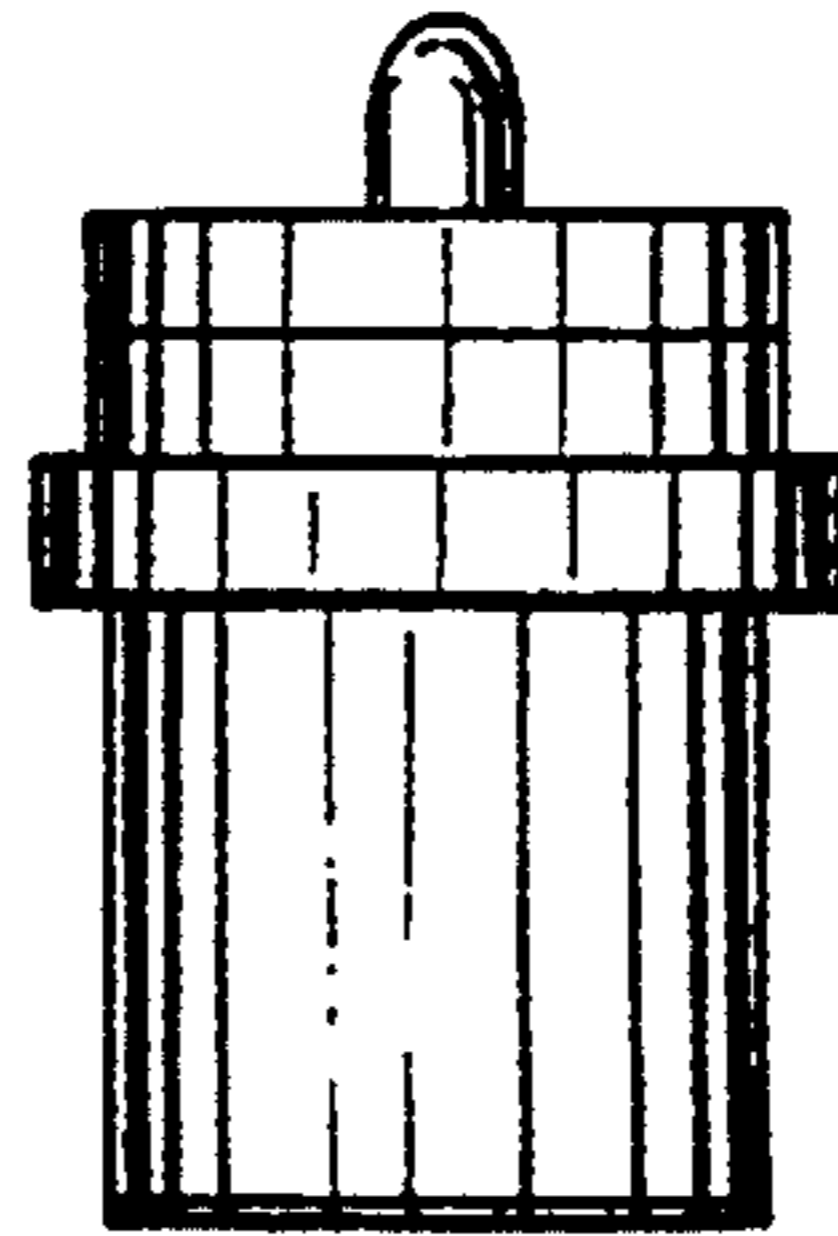

FIG. 66

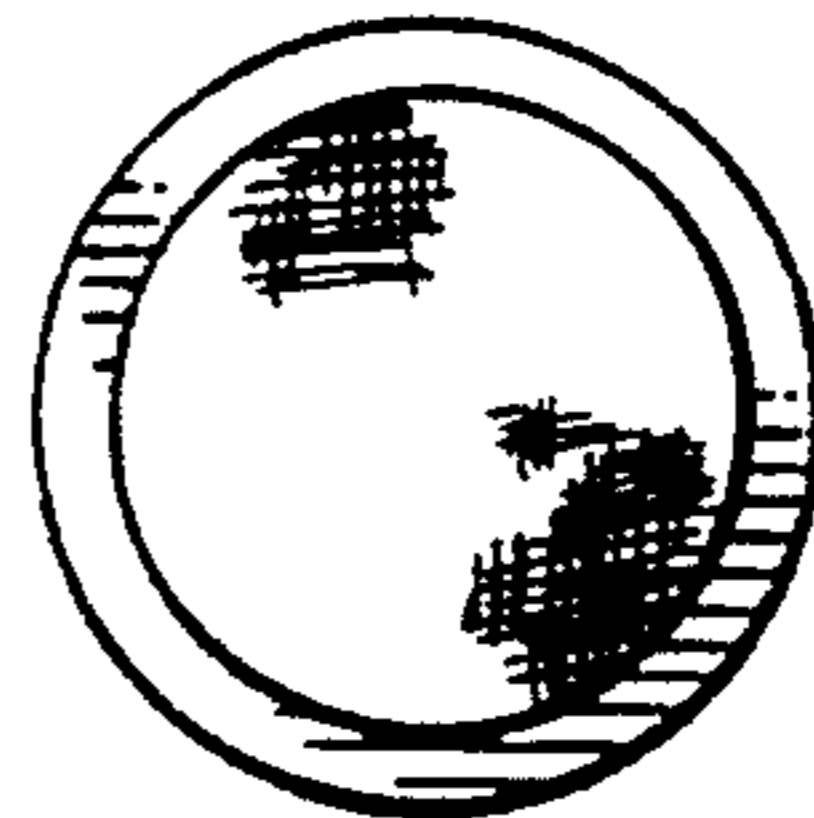

FIG. 67

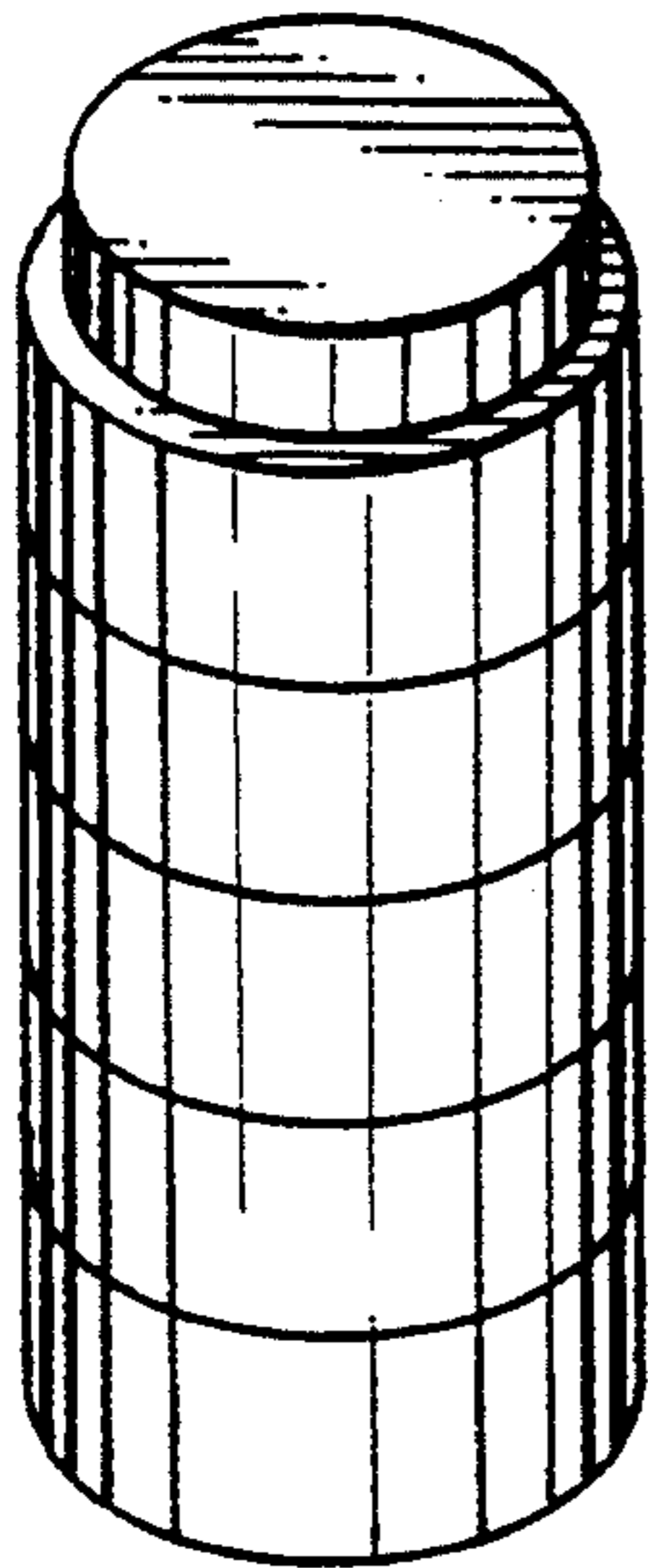

FIG. 68

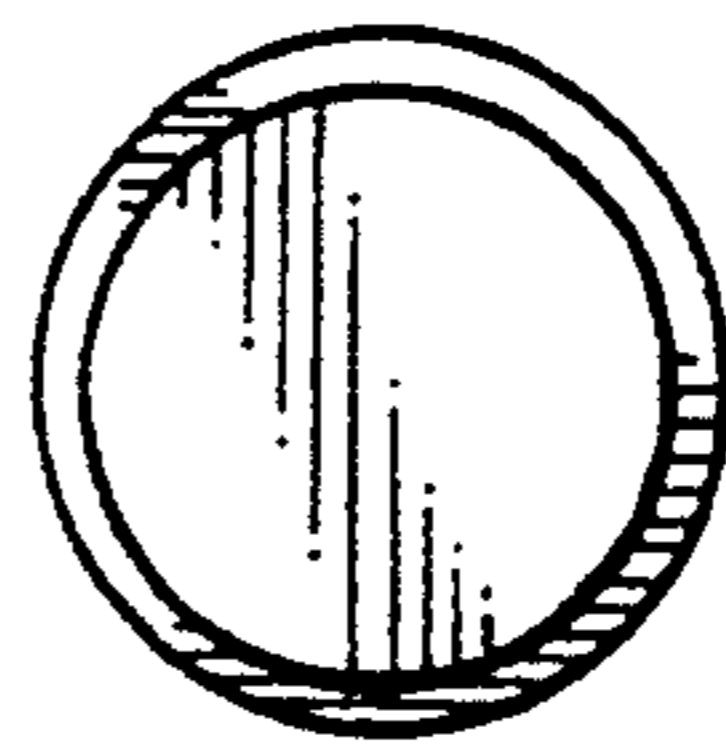

FIG. 69

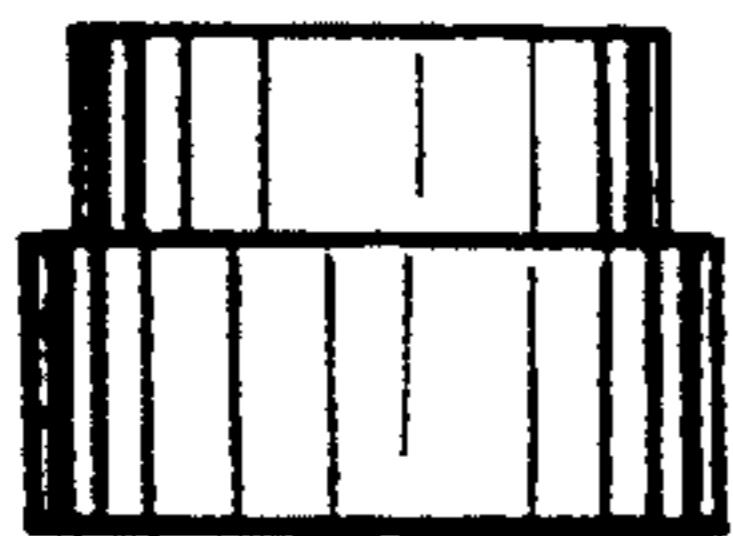

FIG. 70



FIG. 71

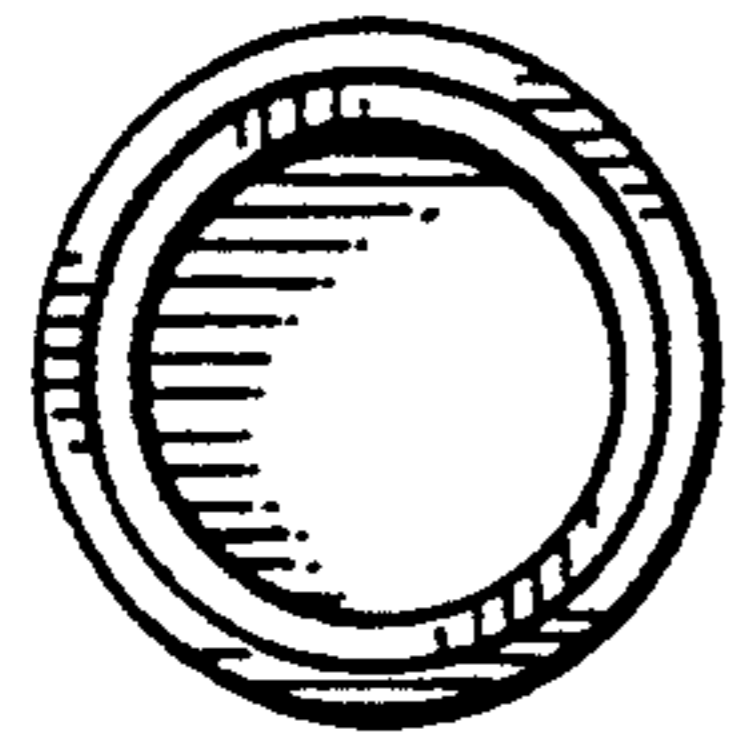

FIG. 72