



US00D352321S

United States Patent [19]
Ivey

[11] **Patent Number: Des. 352,321**
[45] **Date of Patent: ** Nov. 8, 1994**

[54] **REBOUNDER FOR A BASKETBALL GOAL**

[76] **Inventor: James D. Ivey, P.O. Box 2, Rockaway, N.J. 07866**

[**] **Term: 14 Years**

[21] **Appl. No.: 938,339**

[22] **Filed: Sep. 2, 1992**

[52] **U.S. Cl. D21/201**

[58] **Field of Search 273/1.5 R, 1.5 A, 26 A, 273/29 A; 273/396; D21/201**

[56] **References Cited**

U.S. PATENT DOCUMENTS

D. 302,992	8/1989	Scott, III	D21/201
3,001,790	9/1961	Pratt	273/26 A
3,013,801	12/1961	Kirkconnell, Jr.	273/26 A
3,711,092	1/1973	Hogue	273/26 A
5,054,791	10/1991	Ball	273/396

Primary Examiner—Melvin B. Feifer
Assistant Examiner—Cheri Cohen
Attorney, Agent, or Firm—Hugh E. Smith

[57] **CLAIM**

The ornamental design for a rebounder for a basketball goal, as shown and described.

DESCRIPTION

FIG. 1 is a front elevational view of the rebounder for a basketball goal showing my new design; FIG. 2 is a rear elevational view thereof; FIG. 3 is a left side elevational view thereof; FIG. 4 is a right side elevational view thereof; FIG. 5 is a top plan view thereof; FIG. 6 is a bottom plan view thereof; FIG. 7 is a front elevational view with a basketball goal shown in broken lines for illustrative purposes only that form no part of my design; and, FIG. 8 is a left elevational view of FIG. 7.

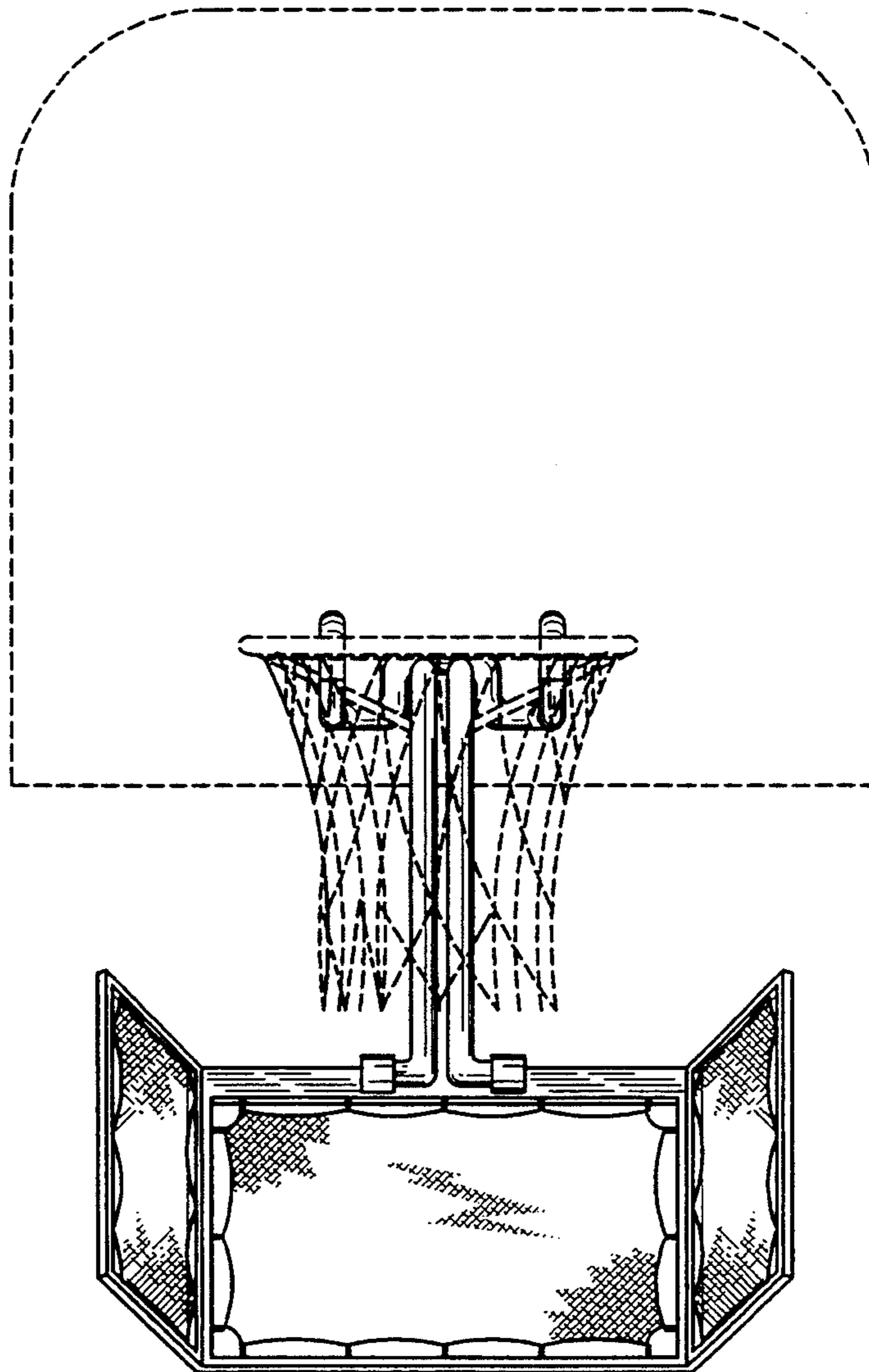

FIG. 1

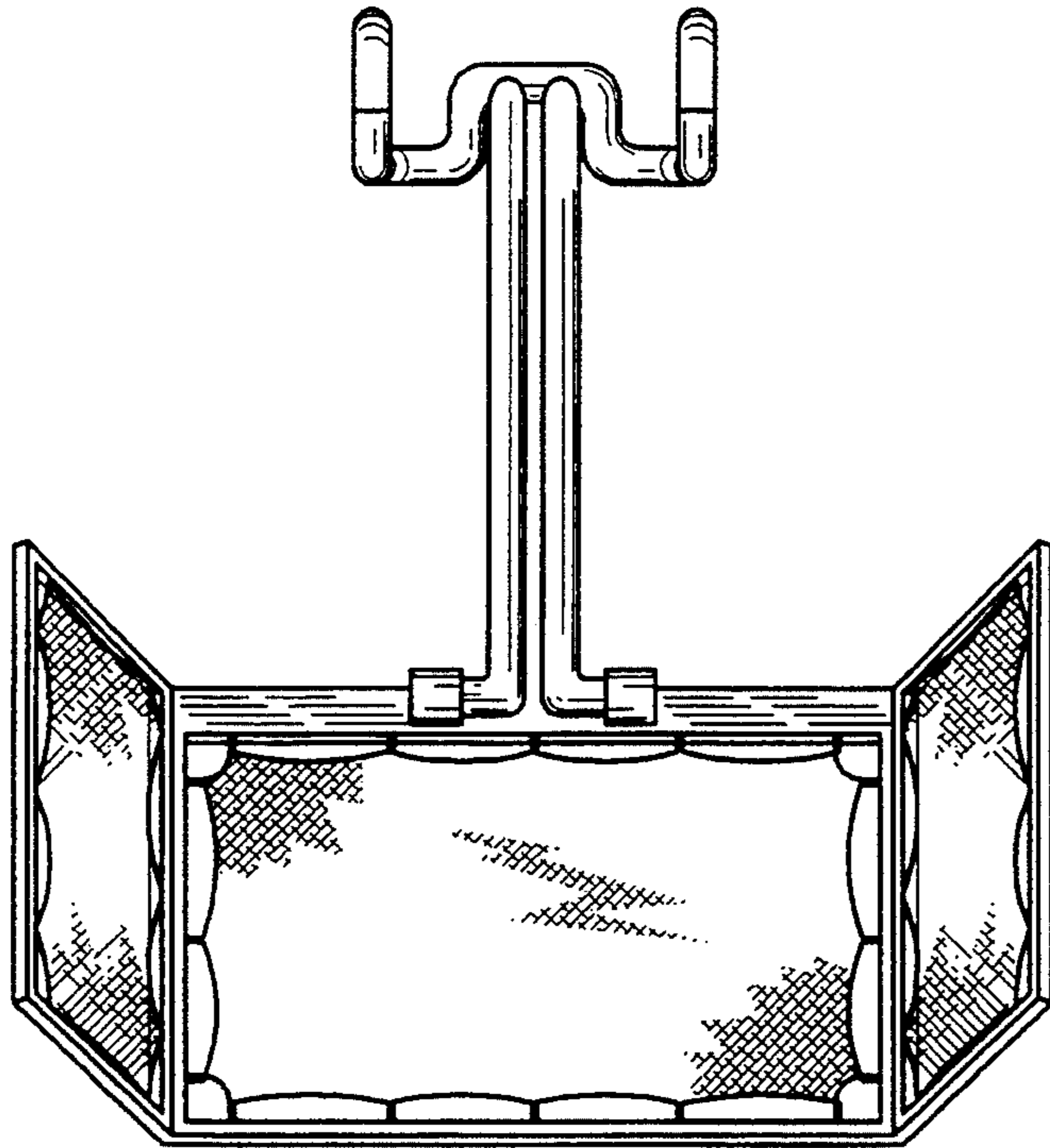

FIG. 2

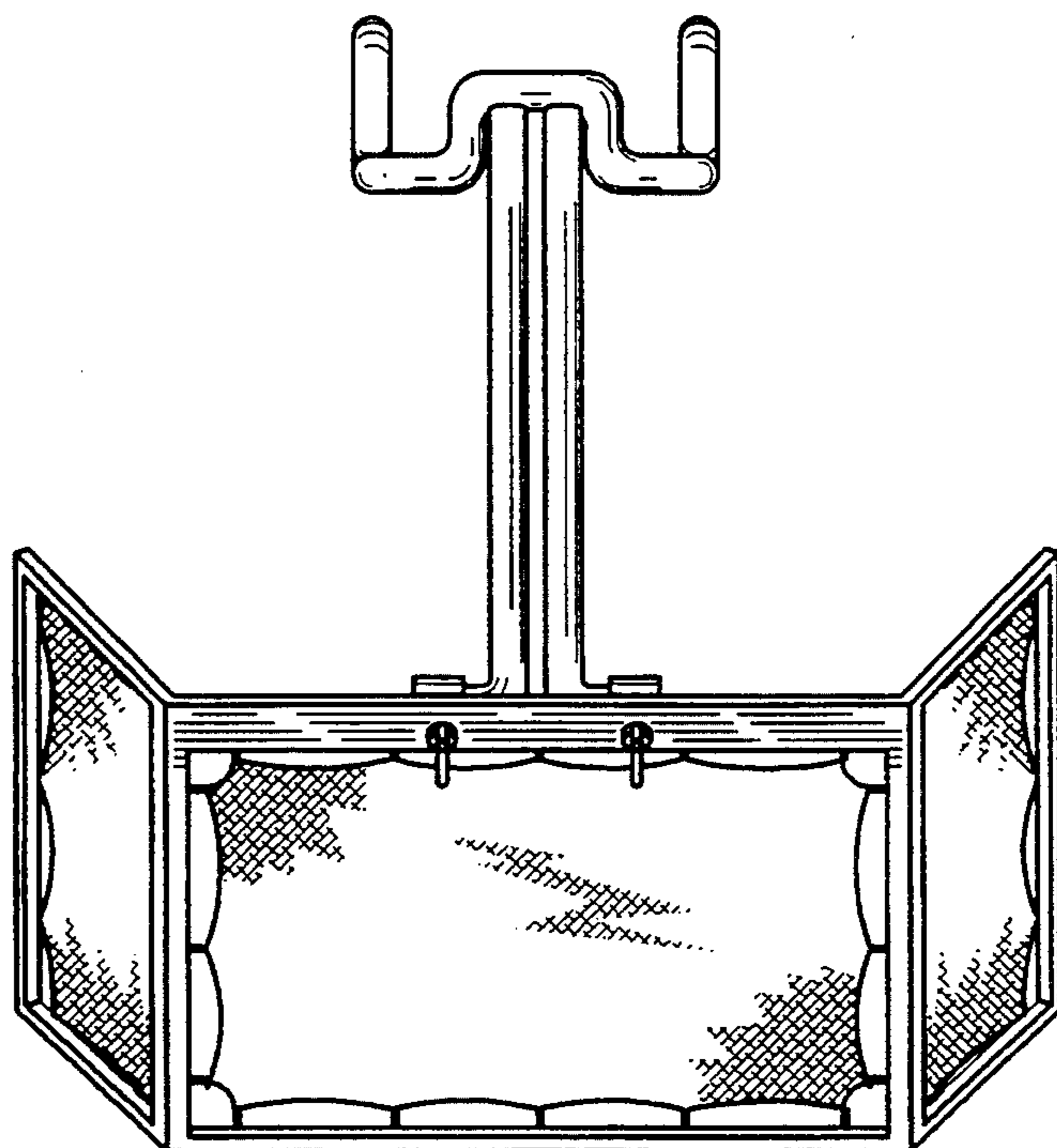

FIG. 3

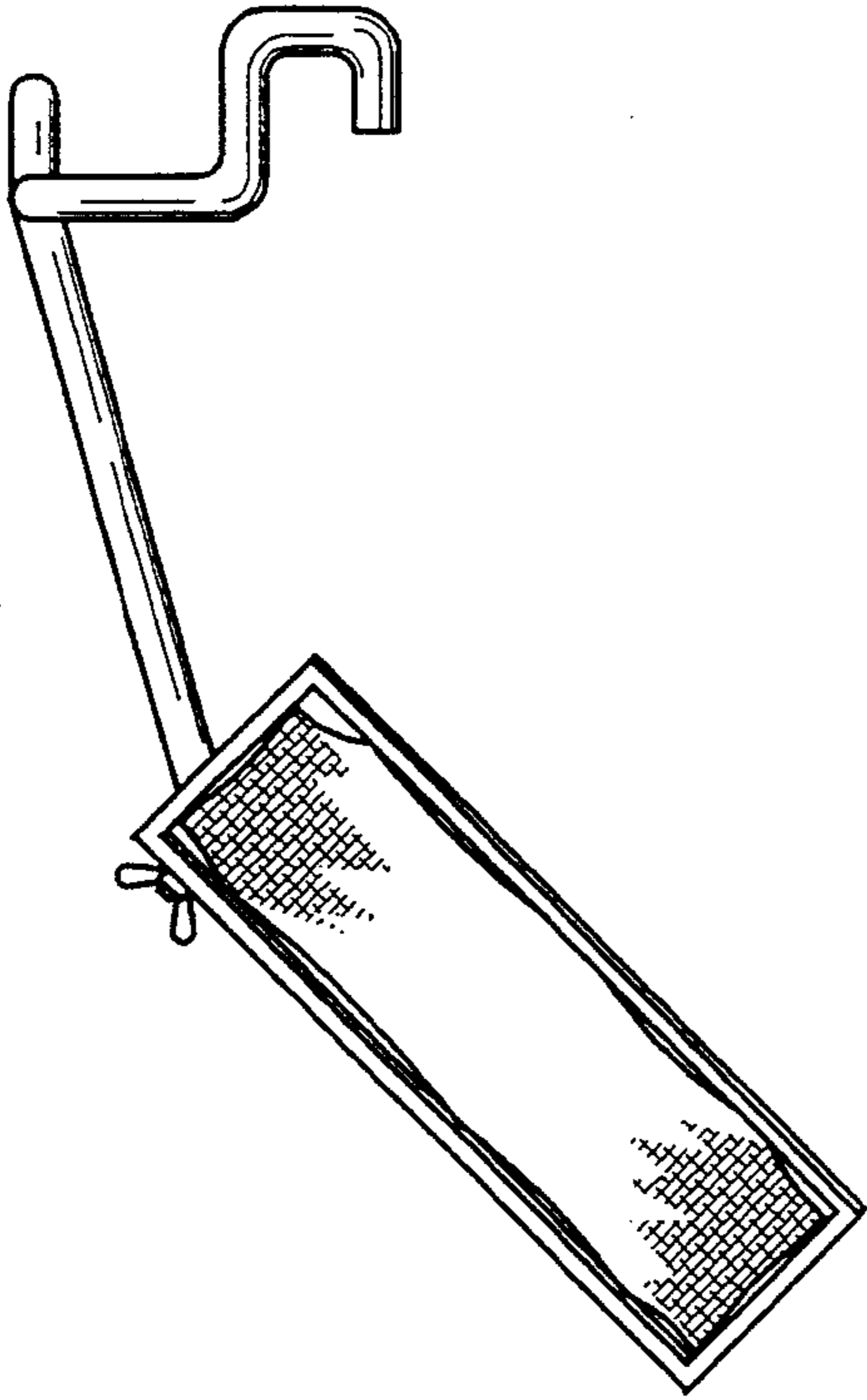

FIG. 4

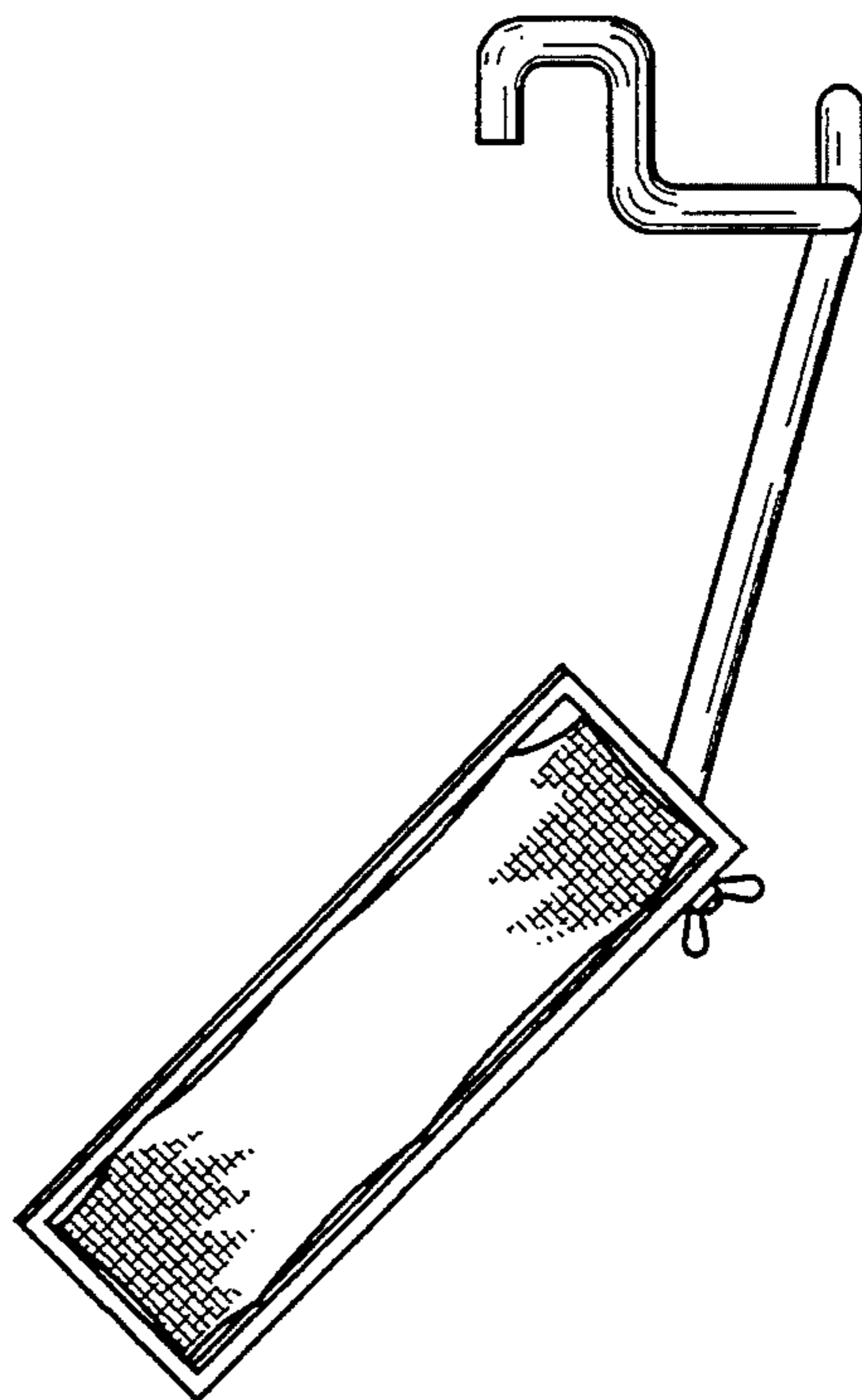

FIG. 5

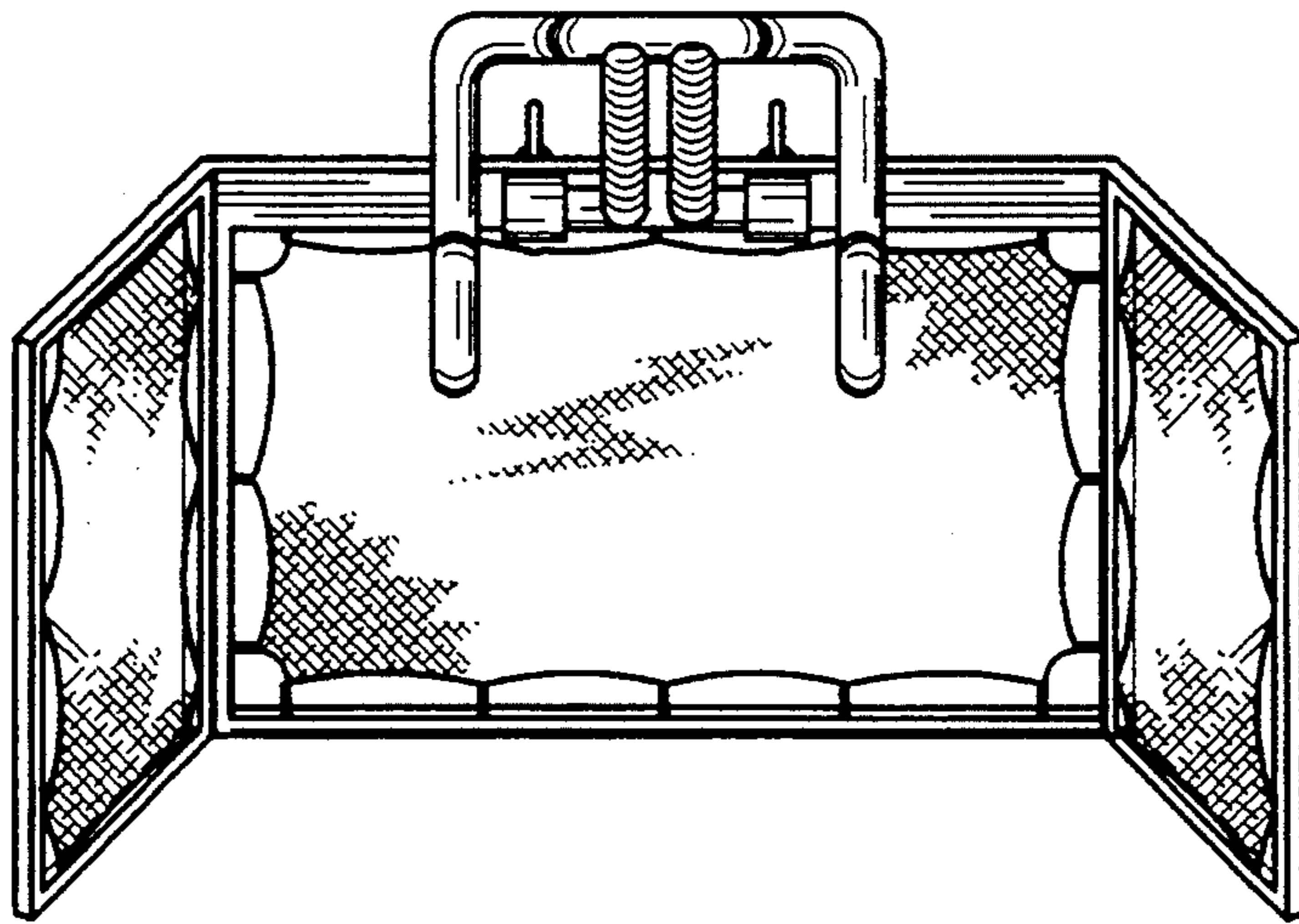

FIG. 6

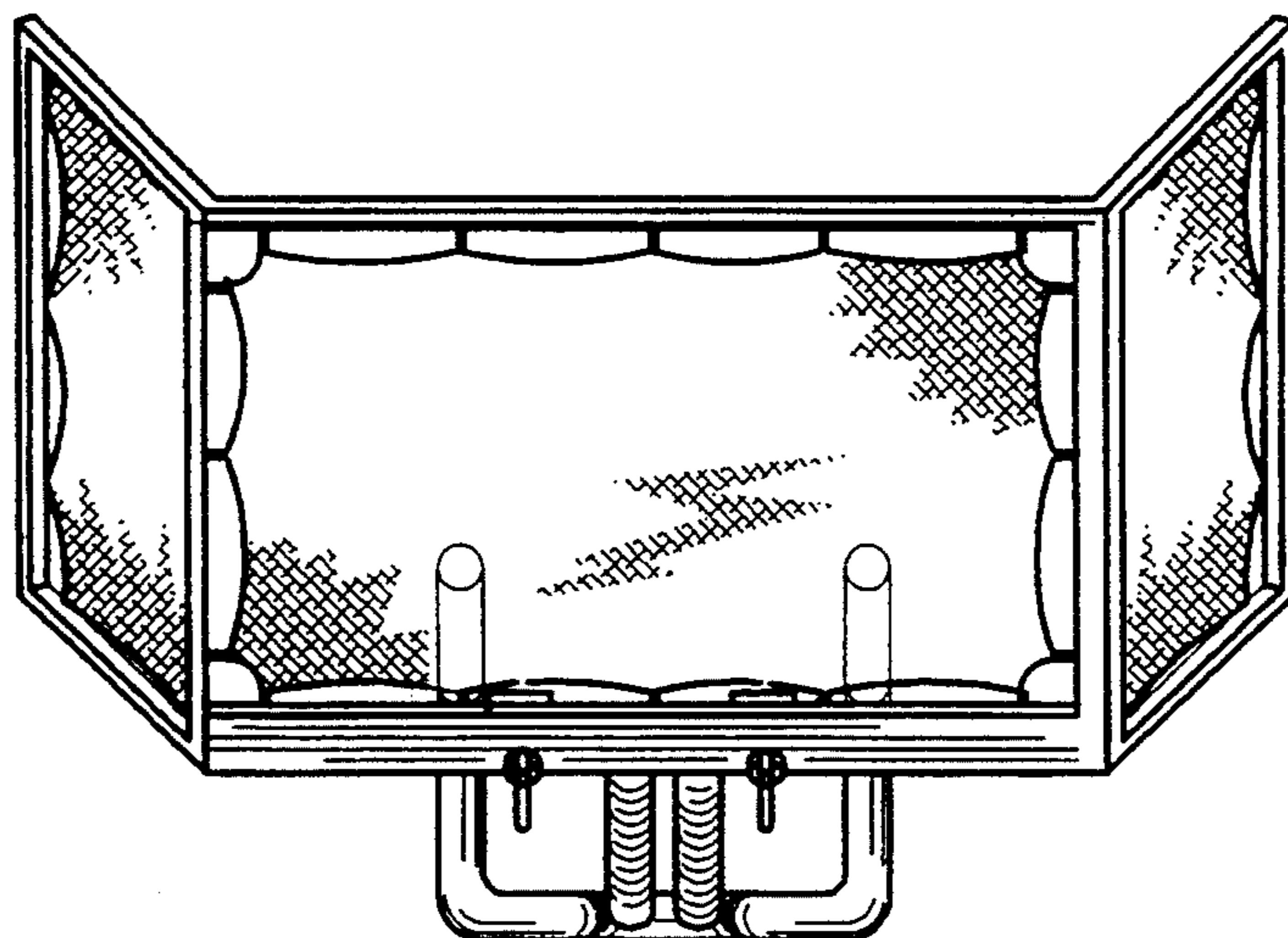

FIG. 7

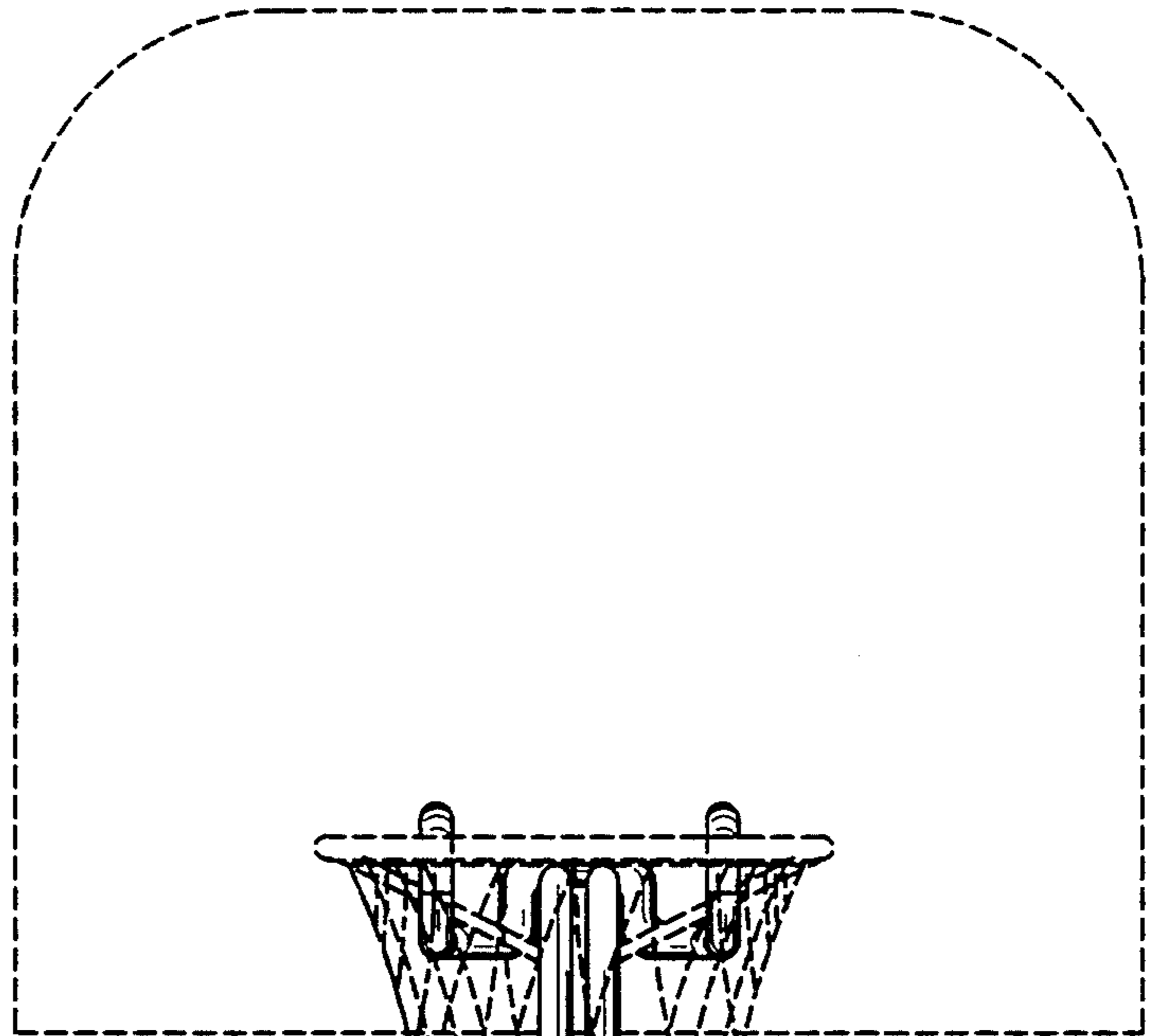

FIG. 8

