



US00D352267S

United States Patent [19]
Blackburn

[11] **Patent Number: Des. 352,267**
[45] **Date of Patent: ** Nov. 8, 1994**

[54] **BICYCLE RACK**
[75] **Inventor: James R. Blackburn, Los Gatos, Calif.**
[73] **Assignee: Blackburn Designs, Inc., Campbell, Calif.**
[**] **Term: 14 Years**
[21] **Appl. No.: 948,975**
[22] **Filed: Sep. 18, 1992**
[52] **U.S. Cl. D12/407**
[58] **Field of Search 224/30 R, 30 A, 32 R, 224/32 A, 35, 39; D12/158**

4,760,943 8/1988 Bass et al. 224/39

OTHER PUBLICATIONS

American Bicycle & Motorcyclist, Apr. 1991, p. 71, The Yuen 1 Combination Bicycle Rack/Tool kit.

Primary Examiner—Wallace R. Burke
Assistant Examiner—M. Brown
Attorney, Agent, or Firm—Robert O. Guillot

[57] **CLAIM**

The ornamental design for a bicycle rack, as shown and described.

DESCRIPTION

FIG. 1 is a perspective view of a bicycle rack showing my new design;
FIG. 2 is a front elevational view thereof;
FIG. 3 is a right side elevational view thereof, the left side view being a mirror image of that shown;
FIG. 4 is a rear elevational view thereof;
FIG. 5 is a top plan view thereof; and,
FIG. 6 is a bottom plan view thereof.

[56] **References Cited**

U.S. PATENT DOCUMENTS

D. 34,016	2/1992	Hsu	D12/158
D. 285,426	9/1986	Blackburn et al.	D12/158
D. 331,382	12/1992	Newbold	D12/158
D. 331,736	12/1992	Newbold	D12/158
D. 336,877	6/1993	Fenton	D12/158

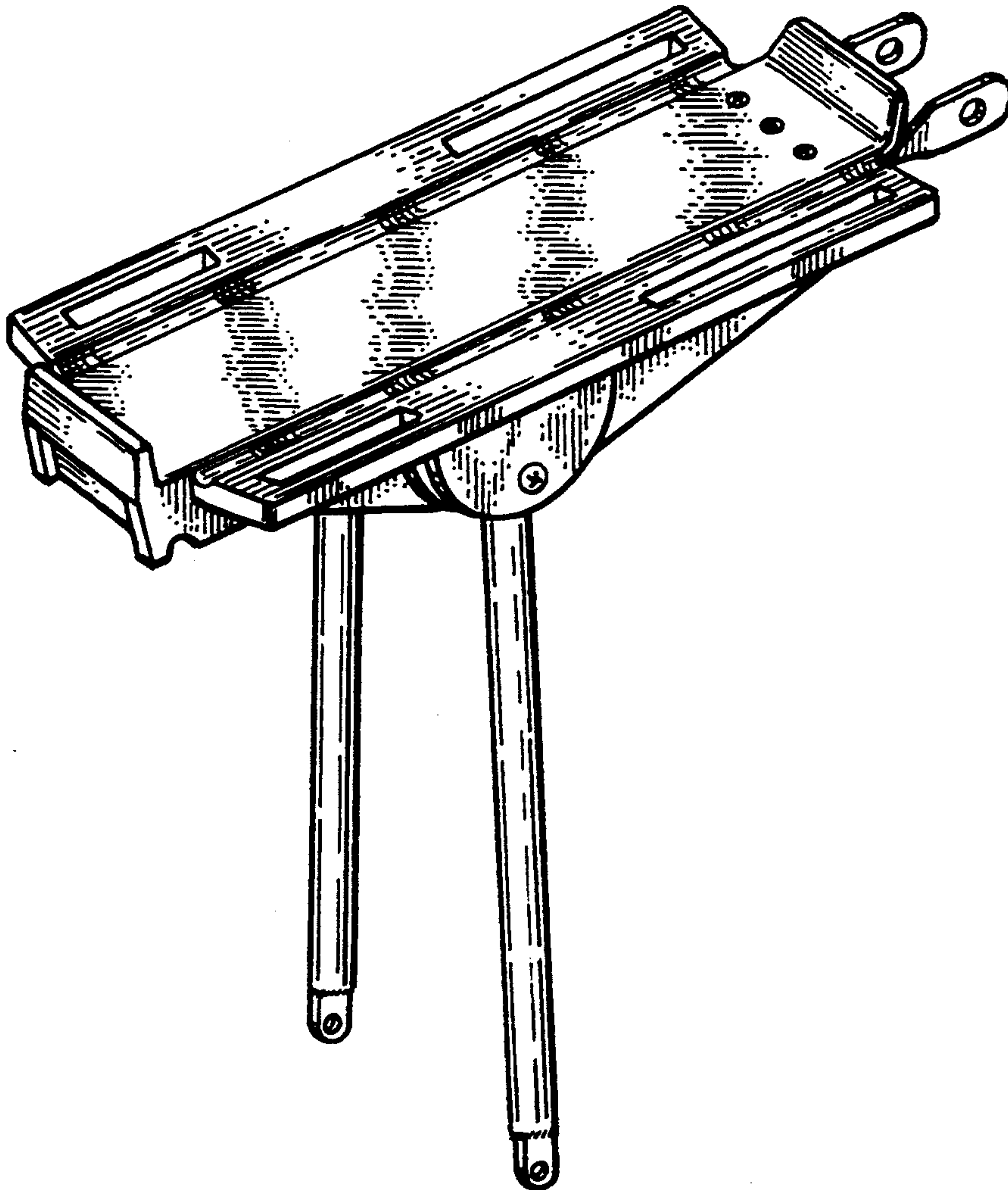

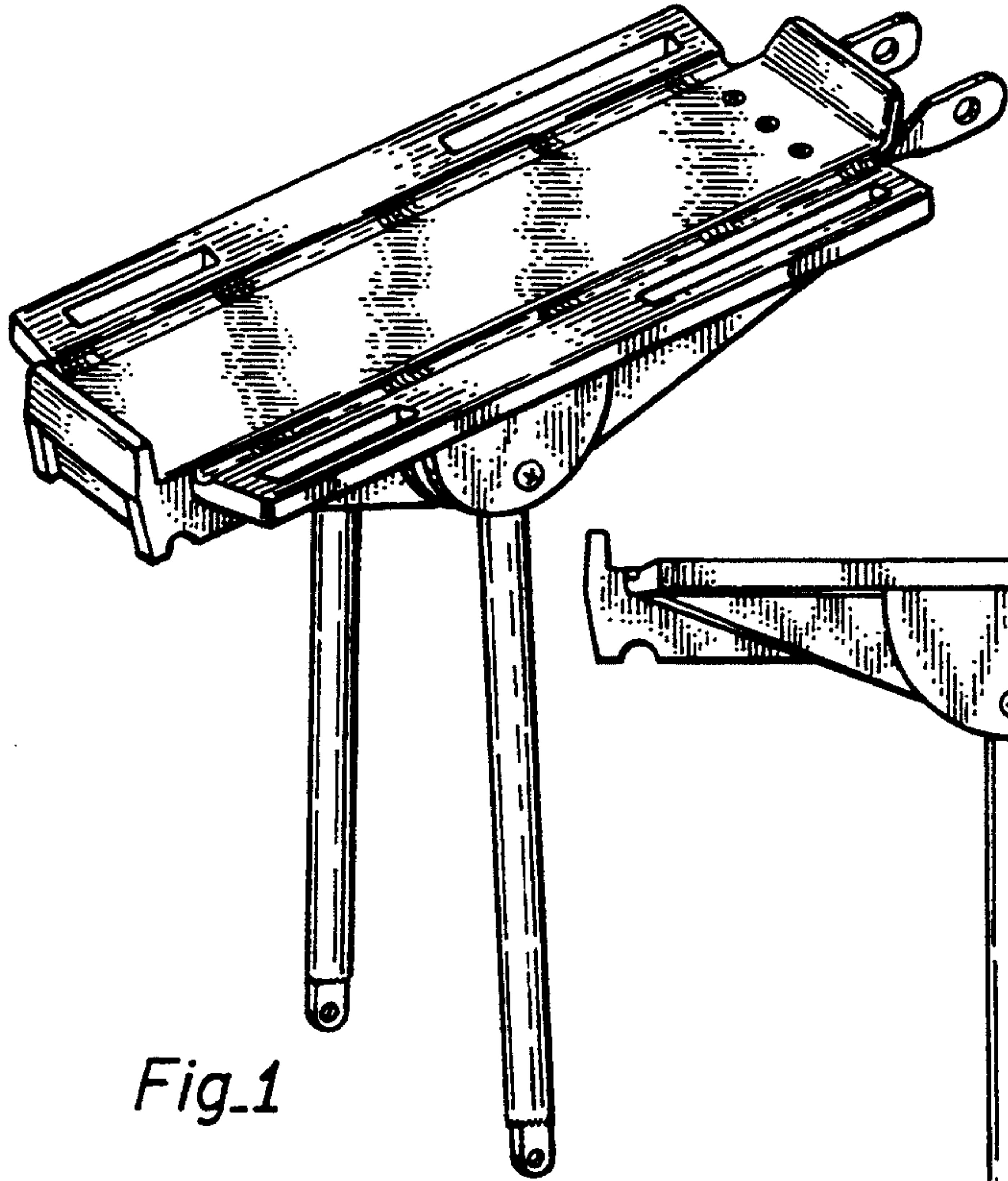

Fig. 1

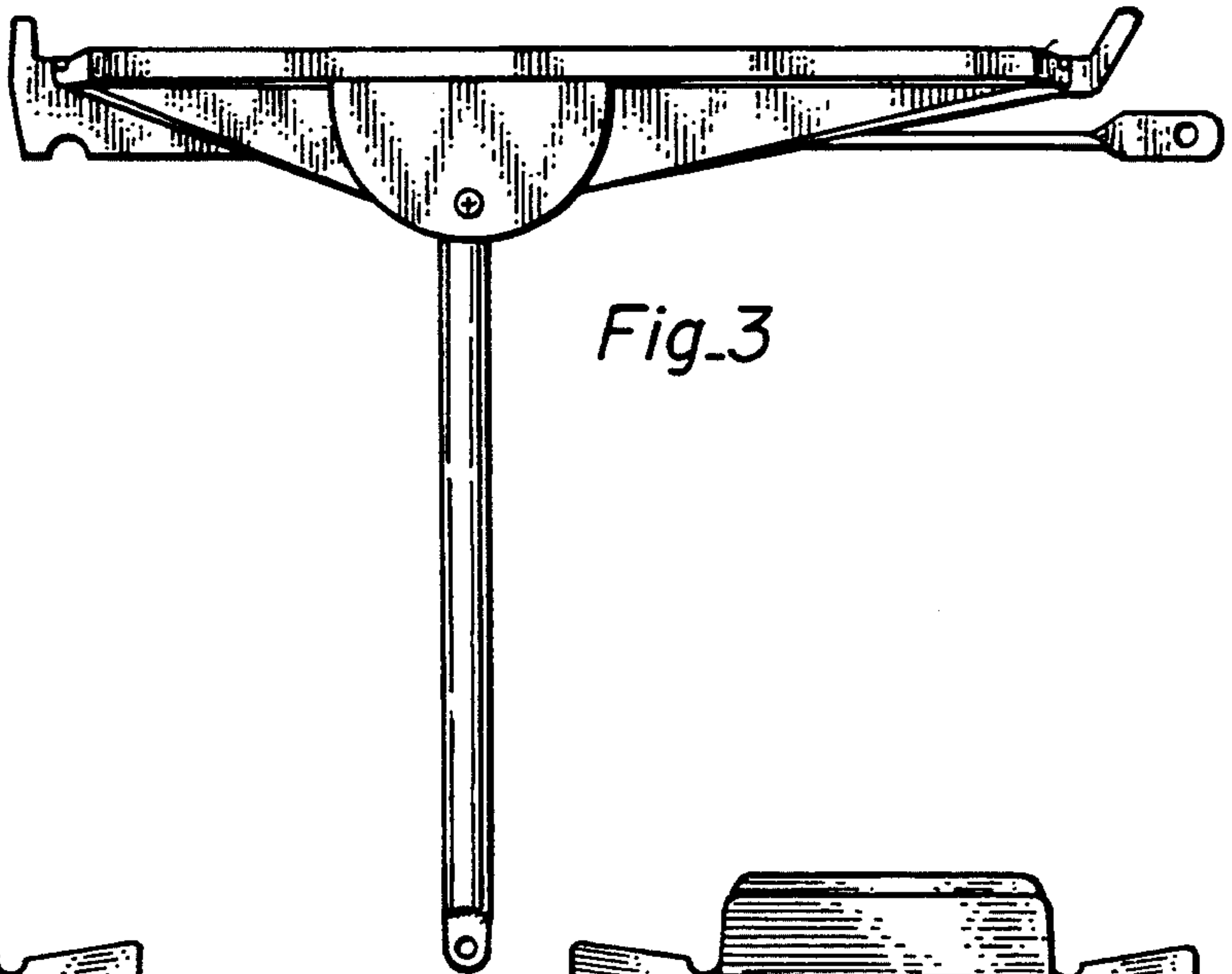

Fig. 3

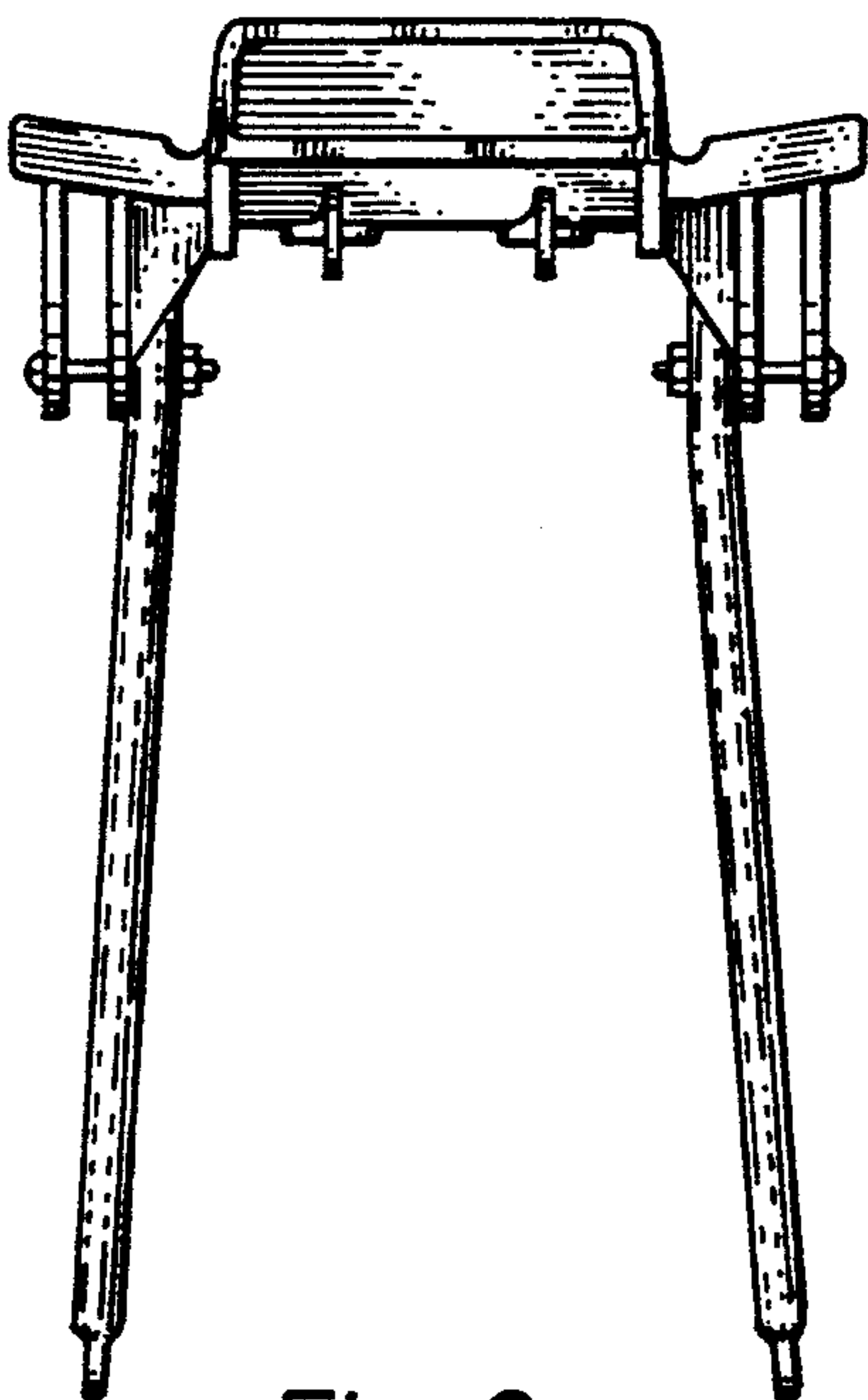

Fig. 2

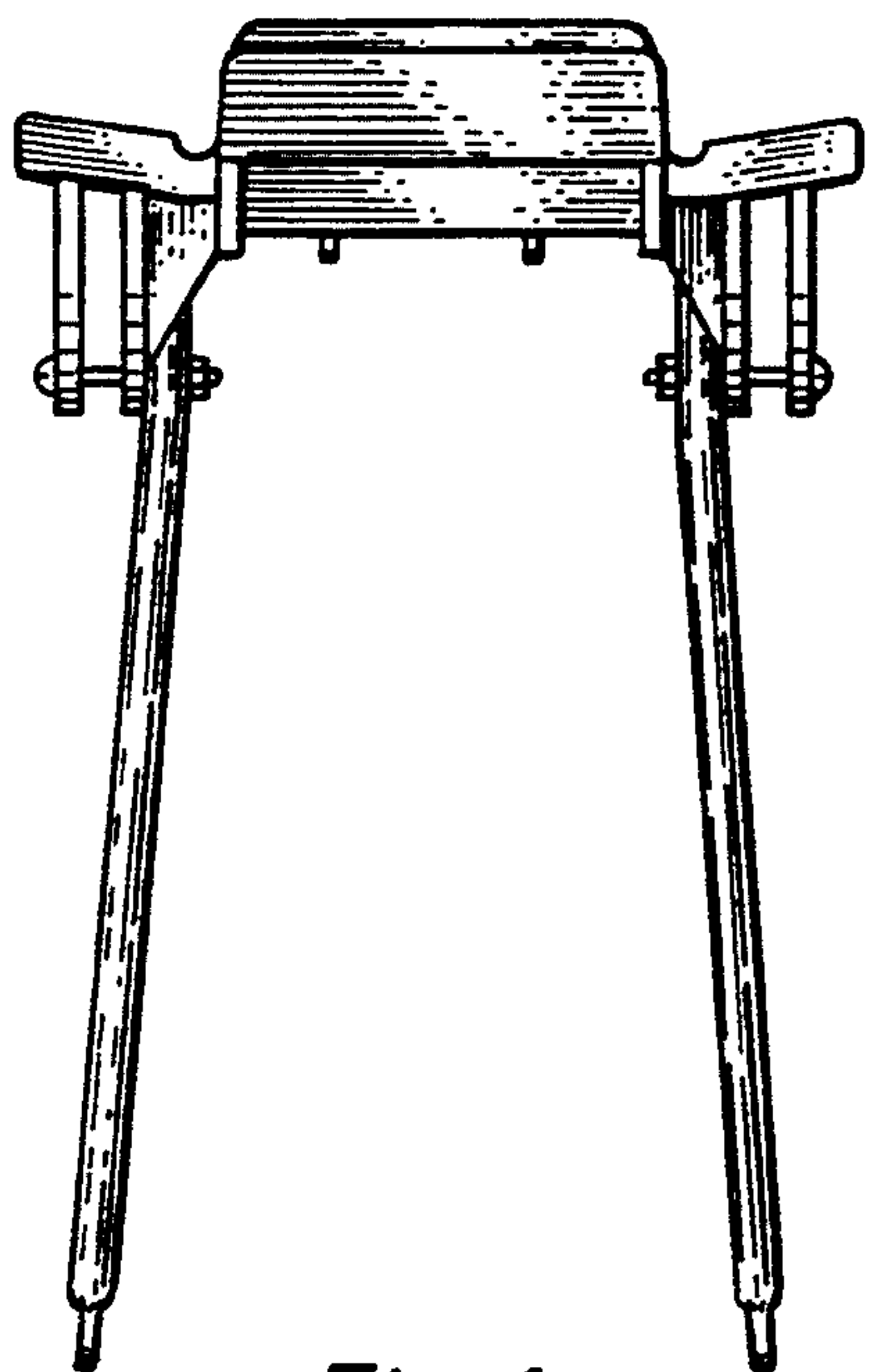
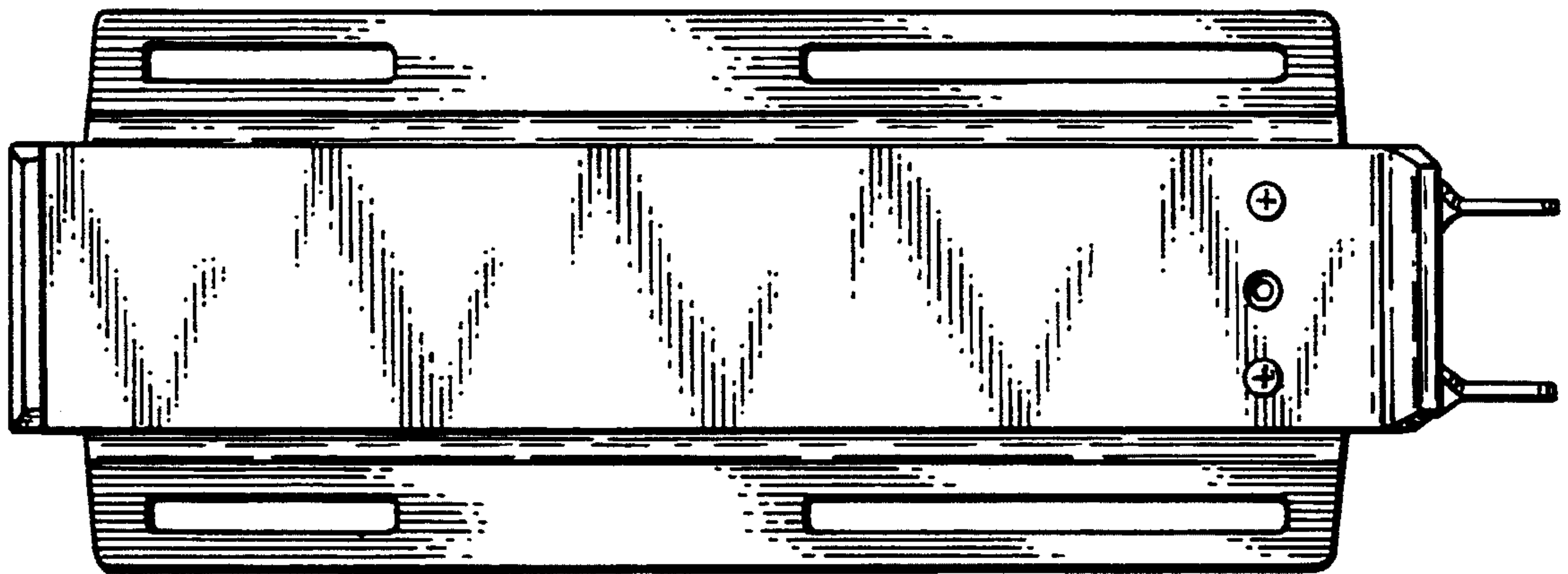
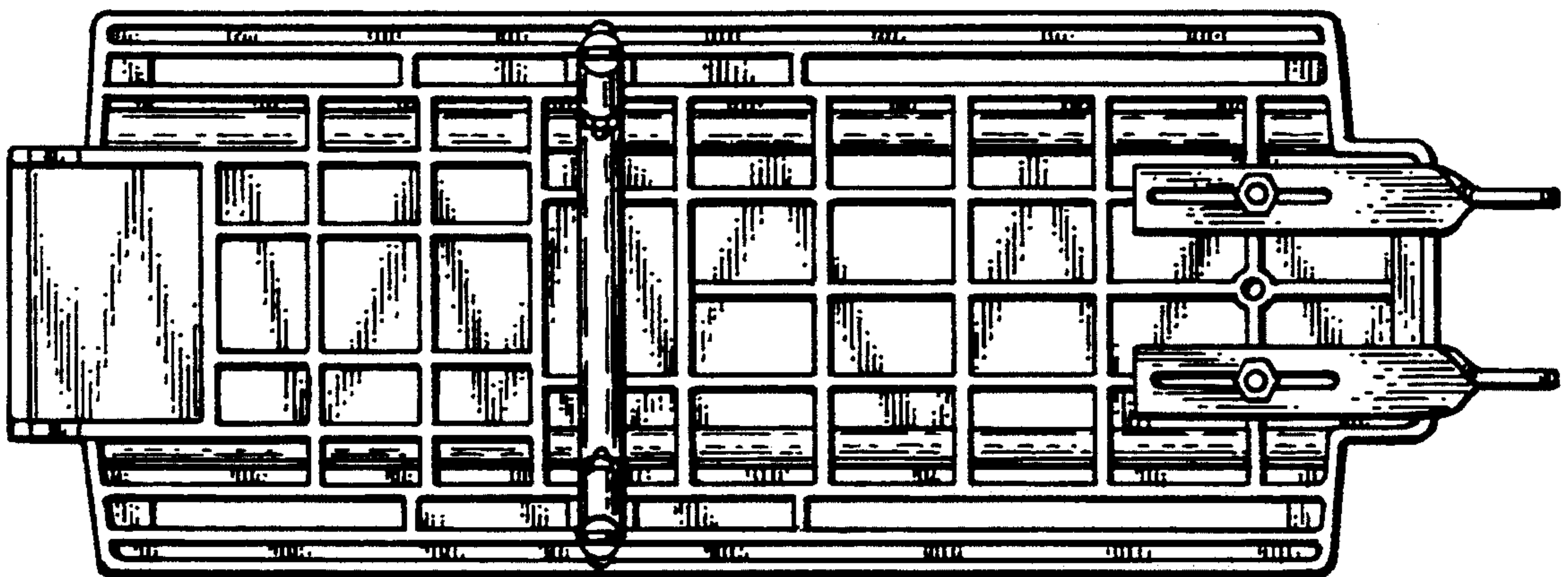

Fig. 4



Fig_5



Fig_6