



US00D352059S

# United States Patent [19]

[11] Patent Number: **Des. 352,059**

**Kubota et al.**

[45] Date of Patent: **\*\* Nov. 1, 1994**

[54] **INK CARTRIDGE FOR PRINTER**  
[75] Inventors: **Hidemi Kubota, Komae; Toshihiko Ujita, Yamato; Kenjiro Watanabe, Tokyo; Torachika Osada, Yokohama; Kayomi Sato, Kawasaki, all of Japan**

D. 338,489 8/1993 Ujita et al. .... D18/56  
D. 341,619 11/1993 Ujita et al. .... D18/56  
D. 341,620 11/1993 Ujita et al. .... D18/56  
4,992,802 2/1991 Dion et al. .... 346/140 R  
5,162,817 11/1991 Tajika et al. .... 346/140 R  
5,187,498 2/1993 Burger ..... 346/140 R

[73] Assignee: **Canon Kabushiki Kaisha, Tokyo, Japan**

### FOREIGN PATENT DOCUMENTS

3958 1/1988 Japan ..... 346/140 R  
4954 1/1988 Japan ..... 346/140 R  
37954 2/1988 Japan ..... 346/140 R

[\*\*] Term: **14 Years**

*Primary Examiner*—Cathy Anne MacCormac  
*Attorney, Agent, or Firm*—Fitzpatrick, Cella, Harper & Scinto

[21] Appl. No.: **10,020**

[22] Filed: **Jun. 28, 1993**

### [57] CLAIM

### [30] Foreign Application Priority Data

Dec. 29, 1992 [JP] Japan ..... 4-38983

The ornamental design for an ink cartridge for printer, as shown and described.

[52] U.S. Cl. .... **D18/56**

[58] Field of Search ..... 346/140 R; 400/280, 400/234; D18/12, 56

### DESCRIPTION

### [56] References Cited

#### U.S. PATENT DOCUMENTS

D. 331,939 12/1992 Ujita ..... D18/12  
D. 338,224 8/1993 Ujita ..... D18/12  
D. 338,232 8/1993 Kotaki et al. .... D18/56  
D. 338,234 8/1993 Watanabe et al. .... D18/56

FIG. 1 is a front elevational view of an ink cartridge for printer showing our new design;  
FIG. 2 is a rear elevational view thereof;  
FIG. 3 is a top plan view thereof;  
FIG. 4 is a bottom plan view thereof;  
FIG. 5 is a left side elevational view thereof;  
FIG. 6 is a right side elevational view thereof; and,  
FIG. 7 is a perspective view thereof.

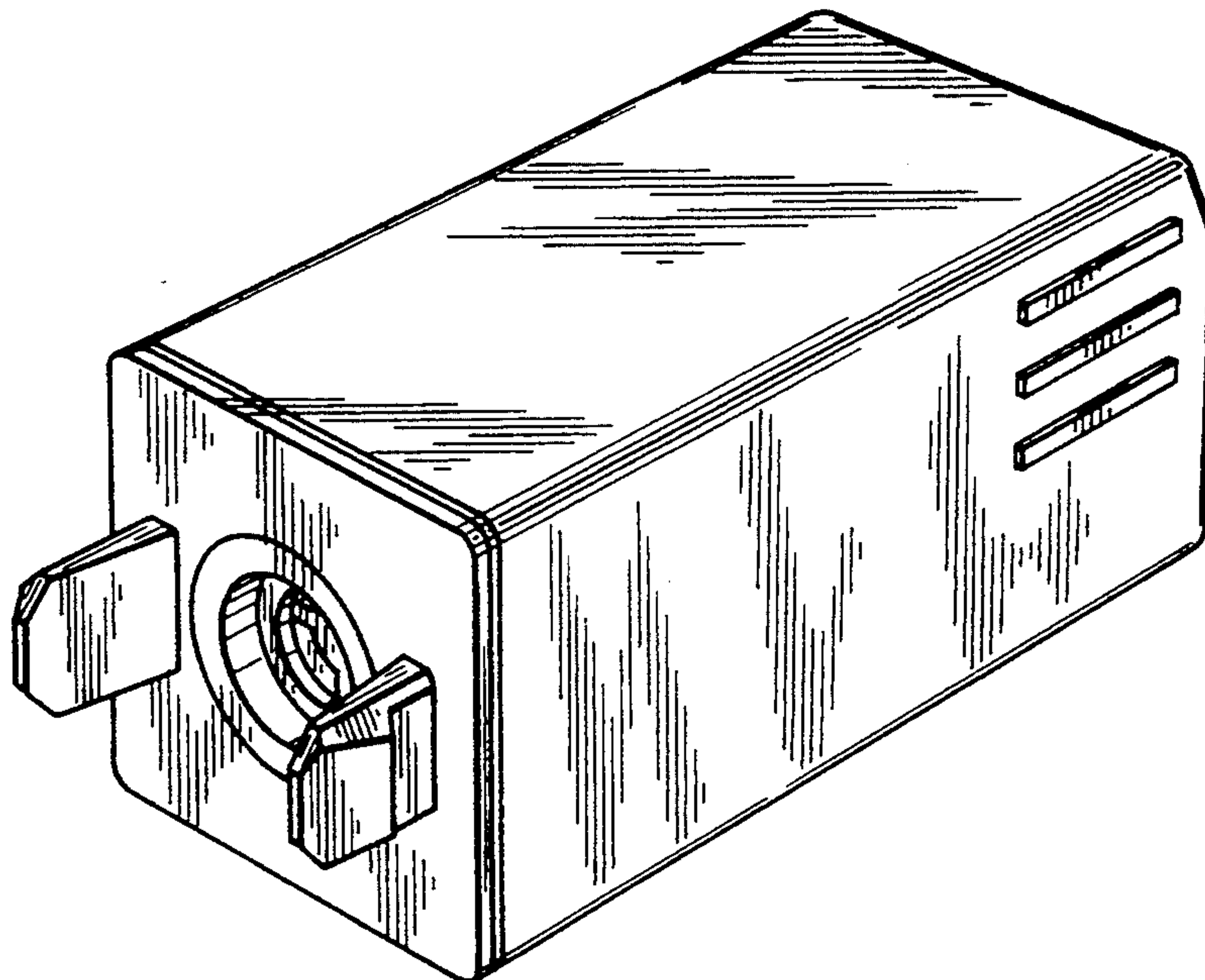

FIG. 1

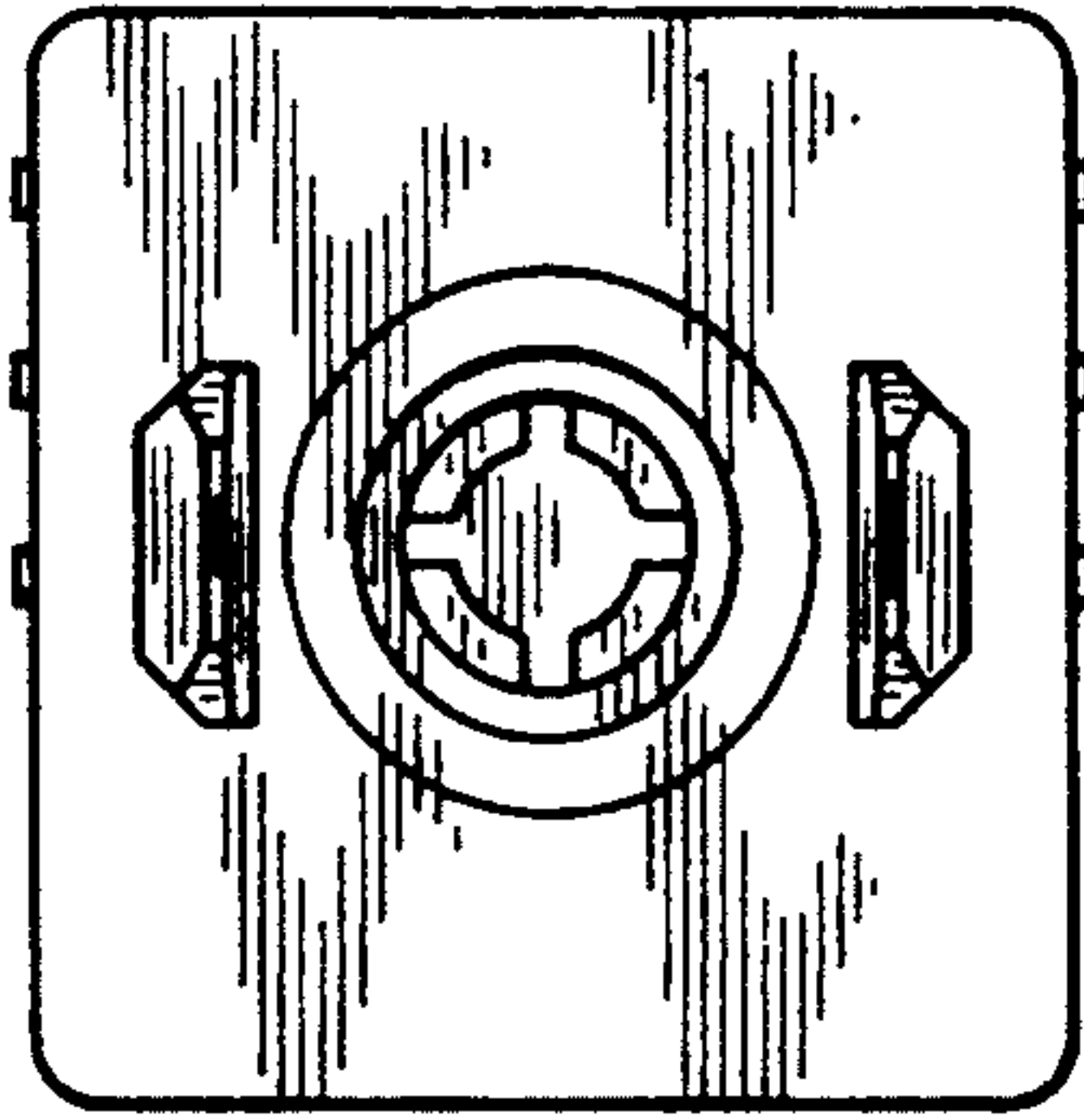

FIG. 2

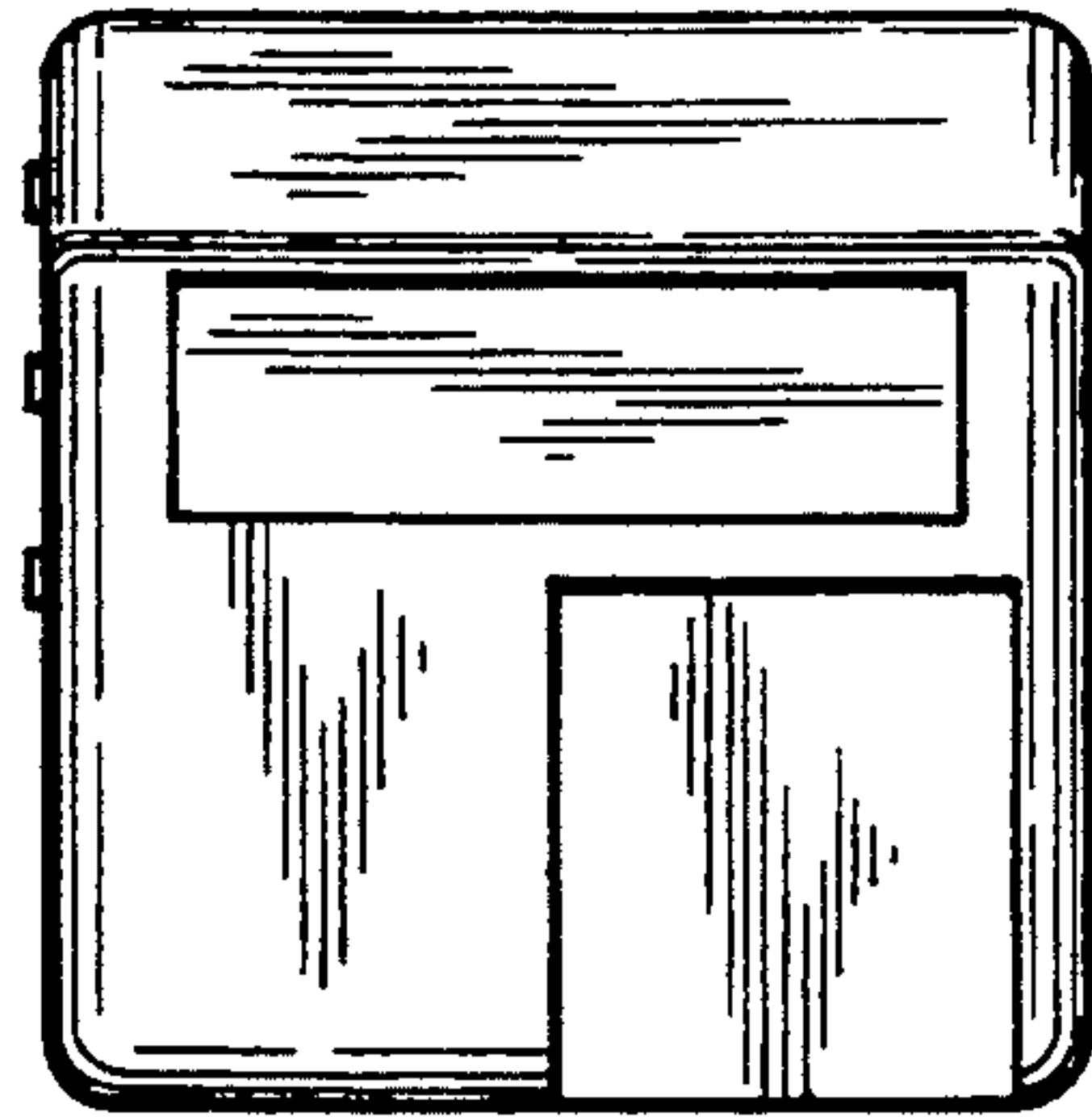

FIG. 3

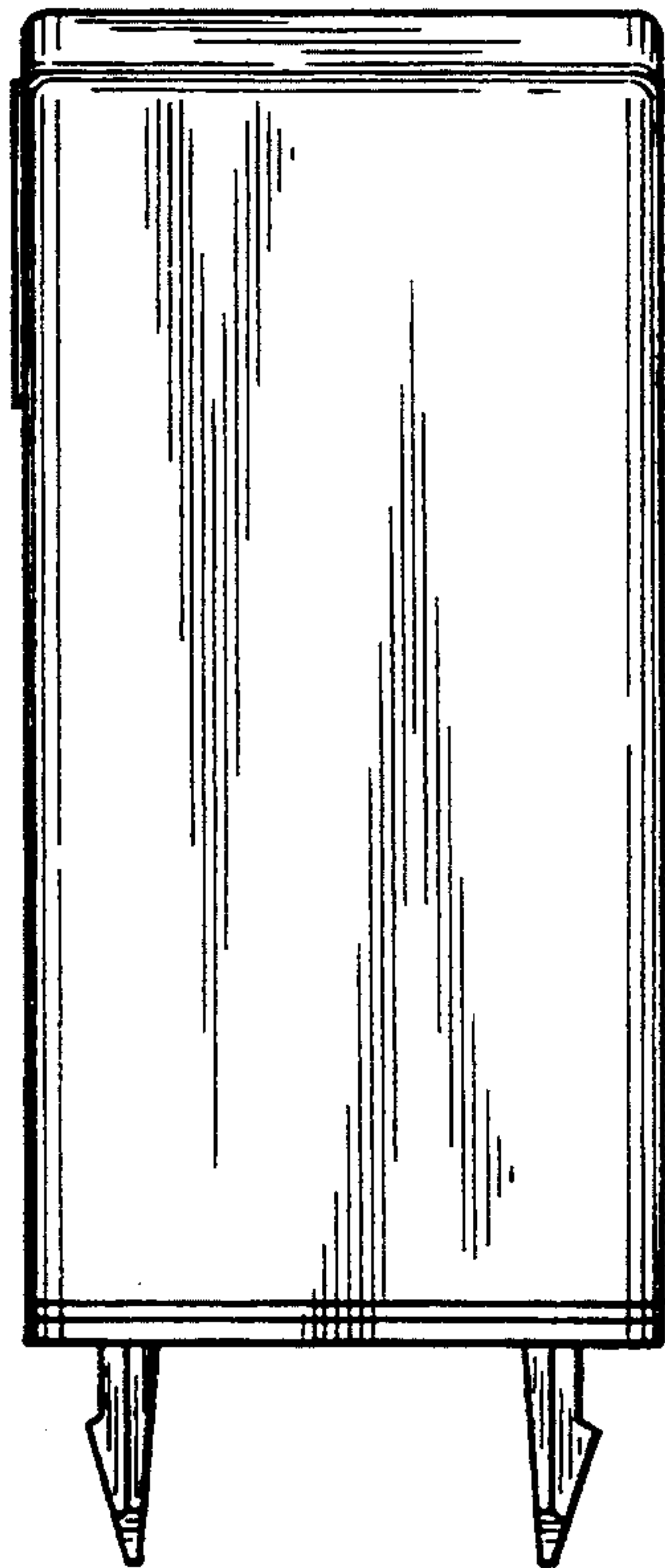

FIG. 4

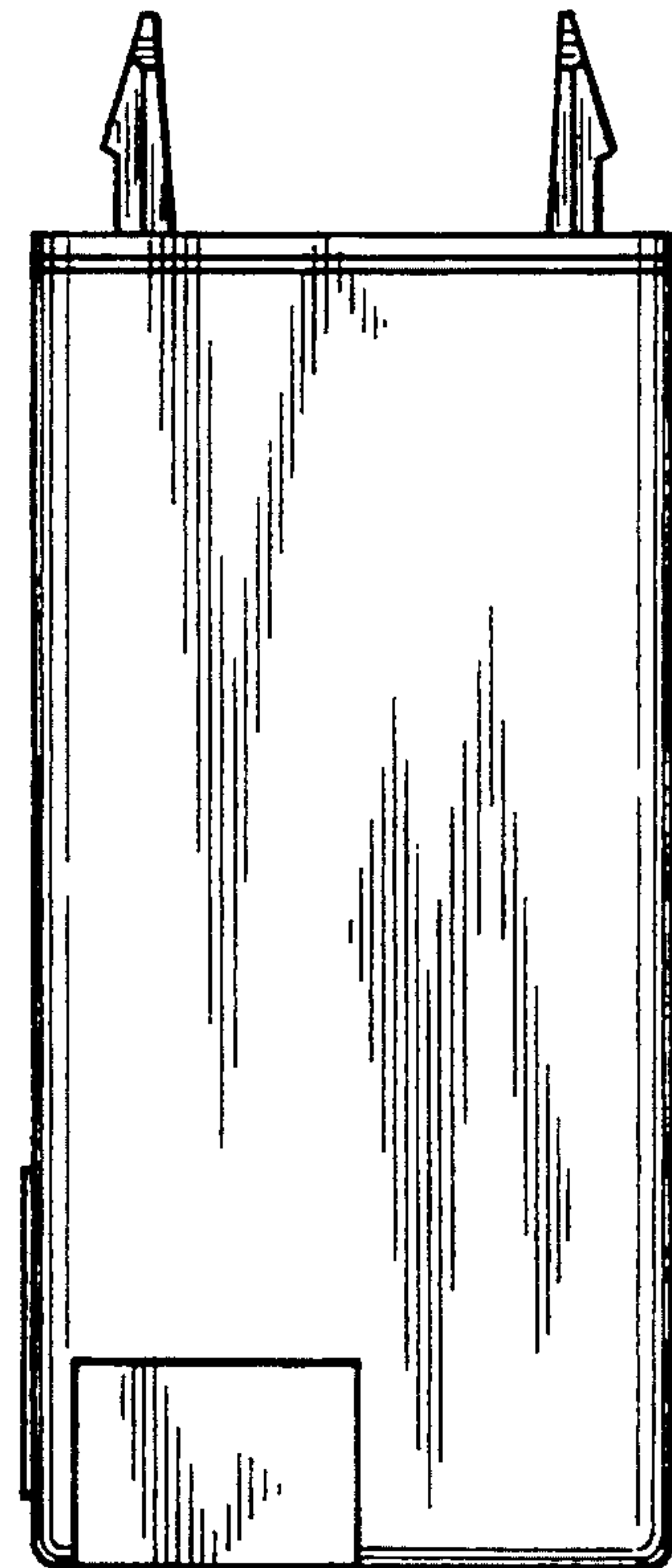

FIG. 5

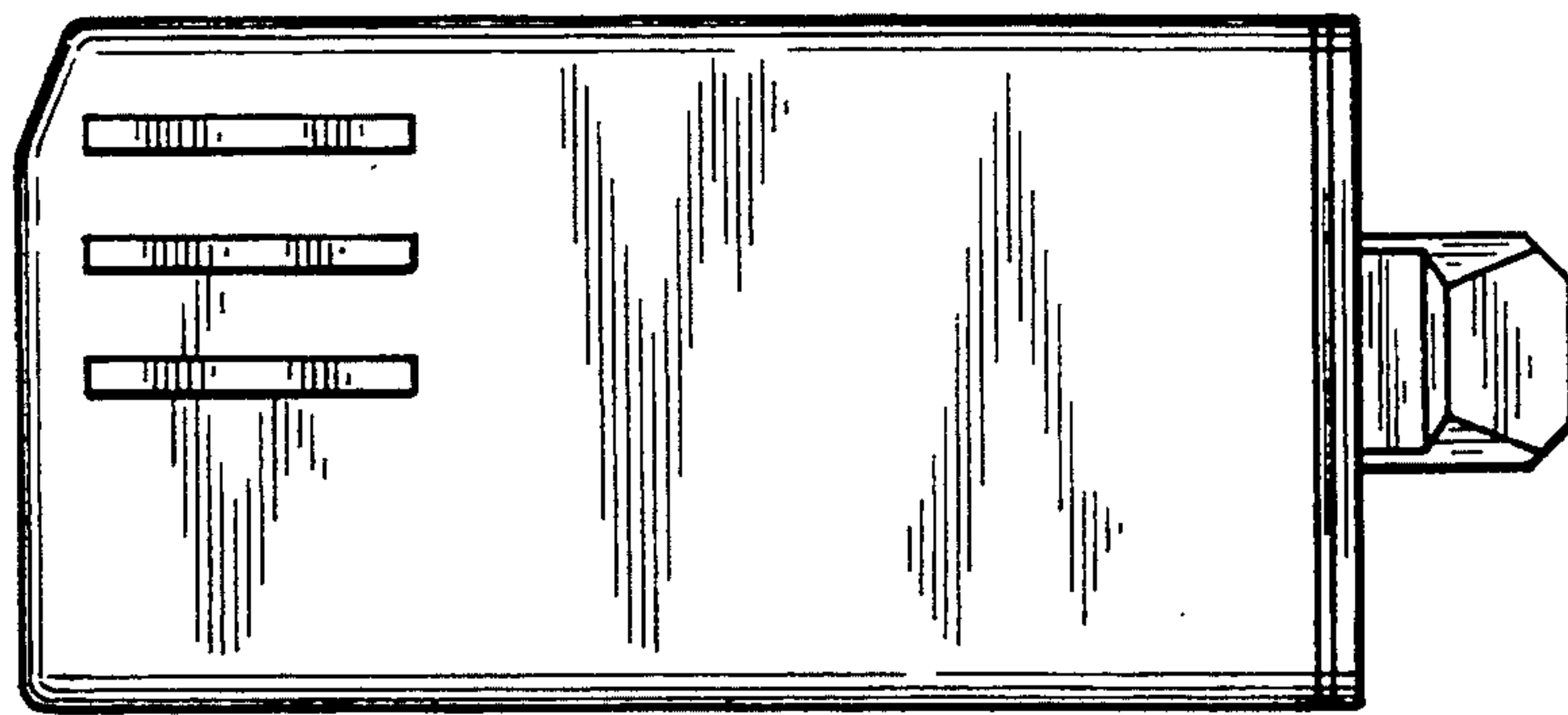

FIG. 6

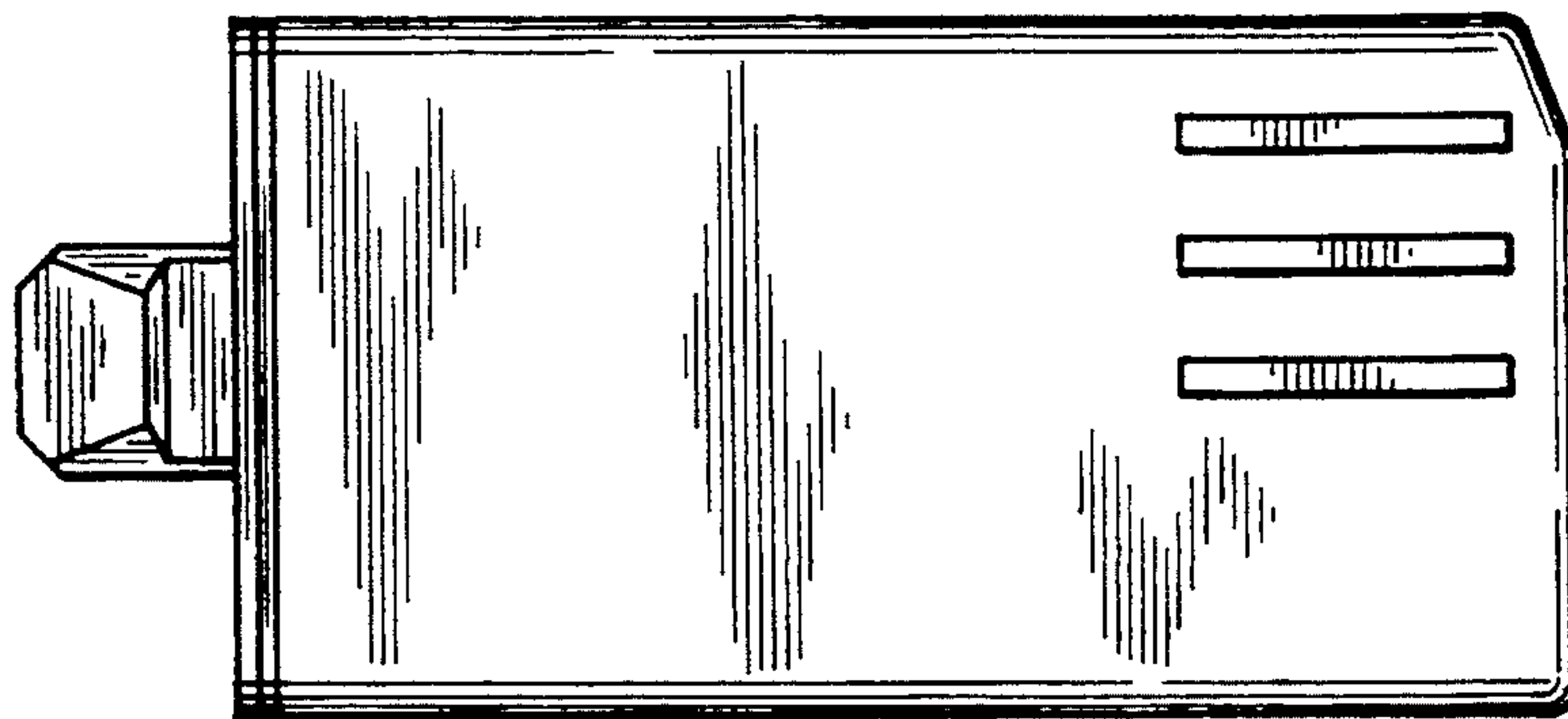

FIG. 7

