



US00D352026S

United States Patent [19]

[11] Patent Number: **Des. 352,026**

Marotti

[45] Date of Patent: **** Nov. 1, 1994**

[54] TAPE AUTOMATION SYSTEM

DESCRIPTION

[75] Inventor: **Martin J. Marotti**, Tucson, Ariz.

[73] Assignee: **International Business Machines Corporation**, Armonk, N.Y.

[**] Term: **14 Years**

[21] Appl. No.: **871,257**

[22] Filed: **Apr. 20, 1992**

[52] U.S. Cl. **D14/108**

[58] Field of Search 360/99.12;
361/390-395; 312/208.1, 223.2, 223.3, 194;
D14/100, 102, 108, 109; D13/162, 184, 199

[56] References Cited

U.S. PATENT DOCUMENTS

D. 284,375	6/1986	Bullock et al.	D14/102
D. 285,075	8/1986	Katai	D14/102
D. 313,797	1/1991	Fenn et al.	D14/102 X
D. 318,272	7/1991	Dow	D14/108
D. 319,637	9/1991	Kusel et al.	D14/108

Primary Examiner—Wallace R. Burke

Assistant Examiner—Freda S. Nunn

Attorney, Agent, or Firm—H. St. Julian; M. W. Schecter

[57] CLAIM

The ornamental design for a tape automation system, as shown and described.

FIG. 1 is a top front and right side perspective view of a tape automation system showing my new design; FIG. 2 is a top front and right side perspective view thereof; FIG. 3 is a front elevational view of thereof; FIG. 4 is a top plan view thereof; FIG. 5 is a bottom plan view thereof; FIG. 6 is a rear elevational view thereof; FIG. 7 is an enlarged right side elevational view thereof; FIG. 8 is an enlarged left side elevational view thereof; FIG. 9 is a top front and right side perspective view of a second embodiment of my new design; FIG. 10 is a top front and right side perspective view thereof; FIG. 11 is a front elevational view thereof; FIG. 12 is a top plan view thereof; FIG. 13 is a bottom plan view thereof; FIG. 14 is a rear elevational view thereof; FIG. 15 is a top front and right side perspective view of a third embodiment of the tape automation system showing my new design; FIG. 16 is a top front and right side perspective view thereof; FIG. 17 is a front elevational view thereof; FIG. 18 is a top plan view thereof; FIG. 19 is a bottom plan view thereof; and, FIG. 20 is a rear elevational view thereof.

The associated tape drives and operator console are shown in broken lines in the views for illustrative purposes only and form no part of the claimed design and the undisclosed left side of the second and third embodiment is identical in appearance to that of the first embodiment.

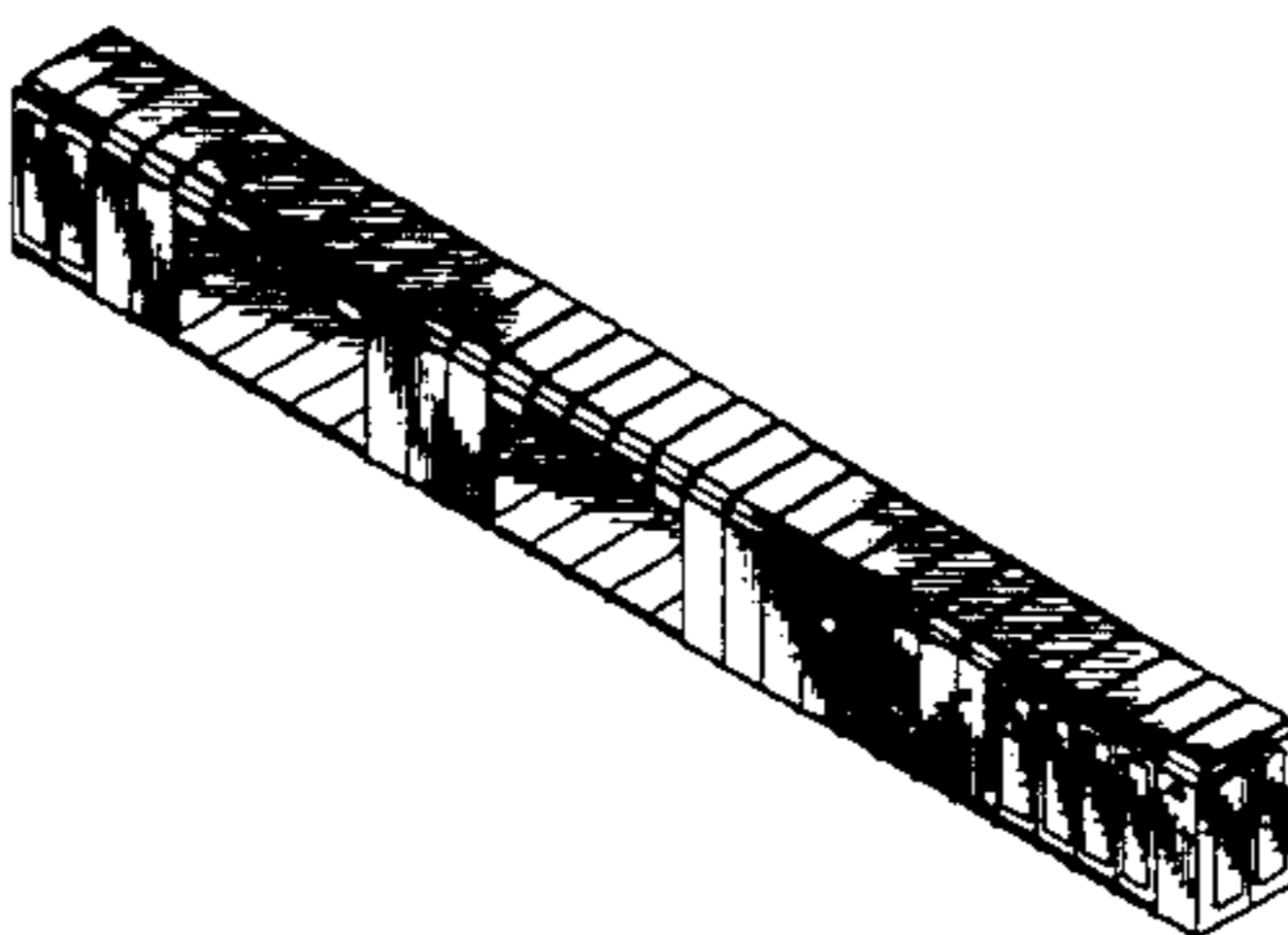
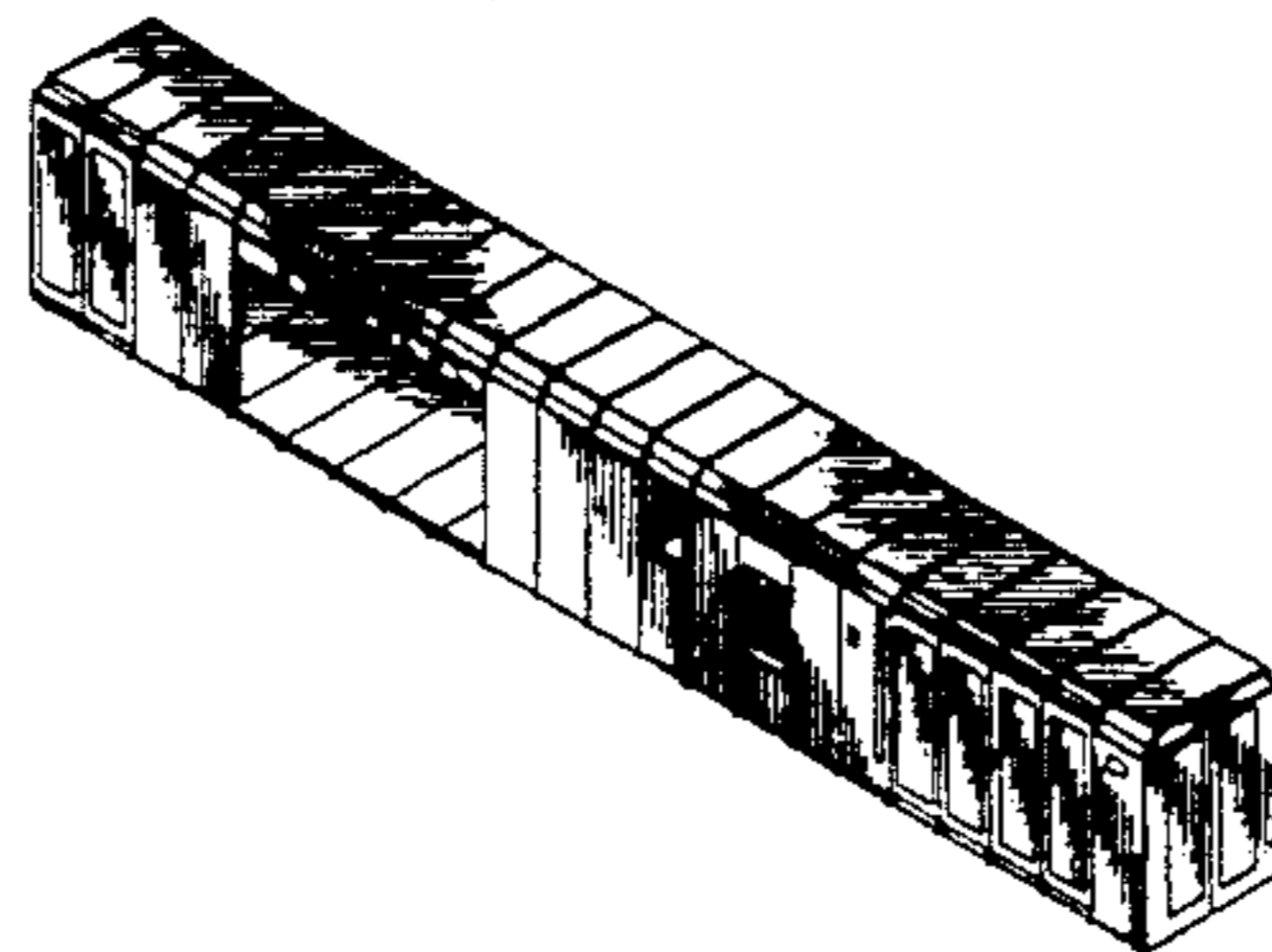
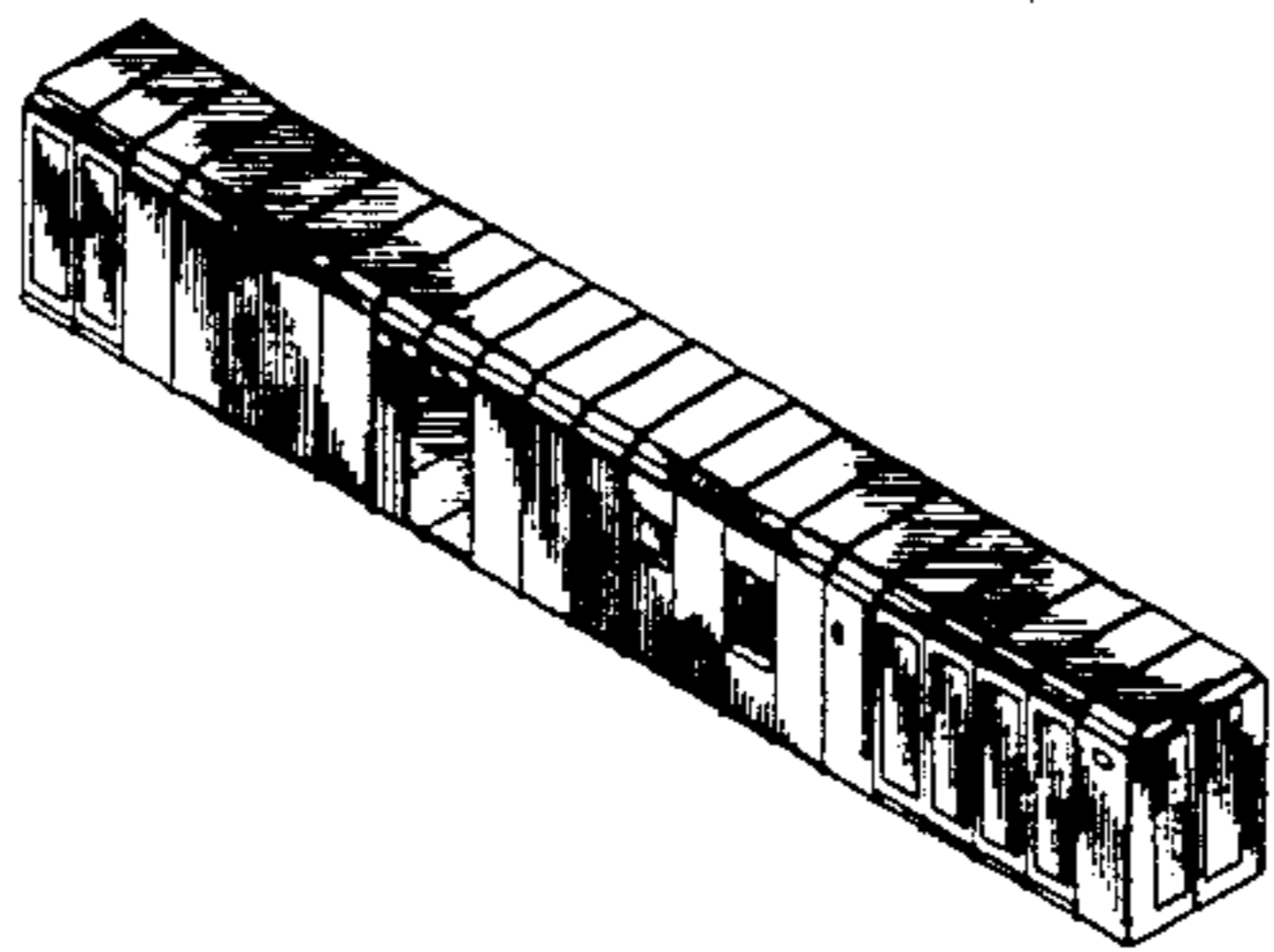

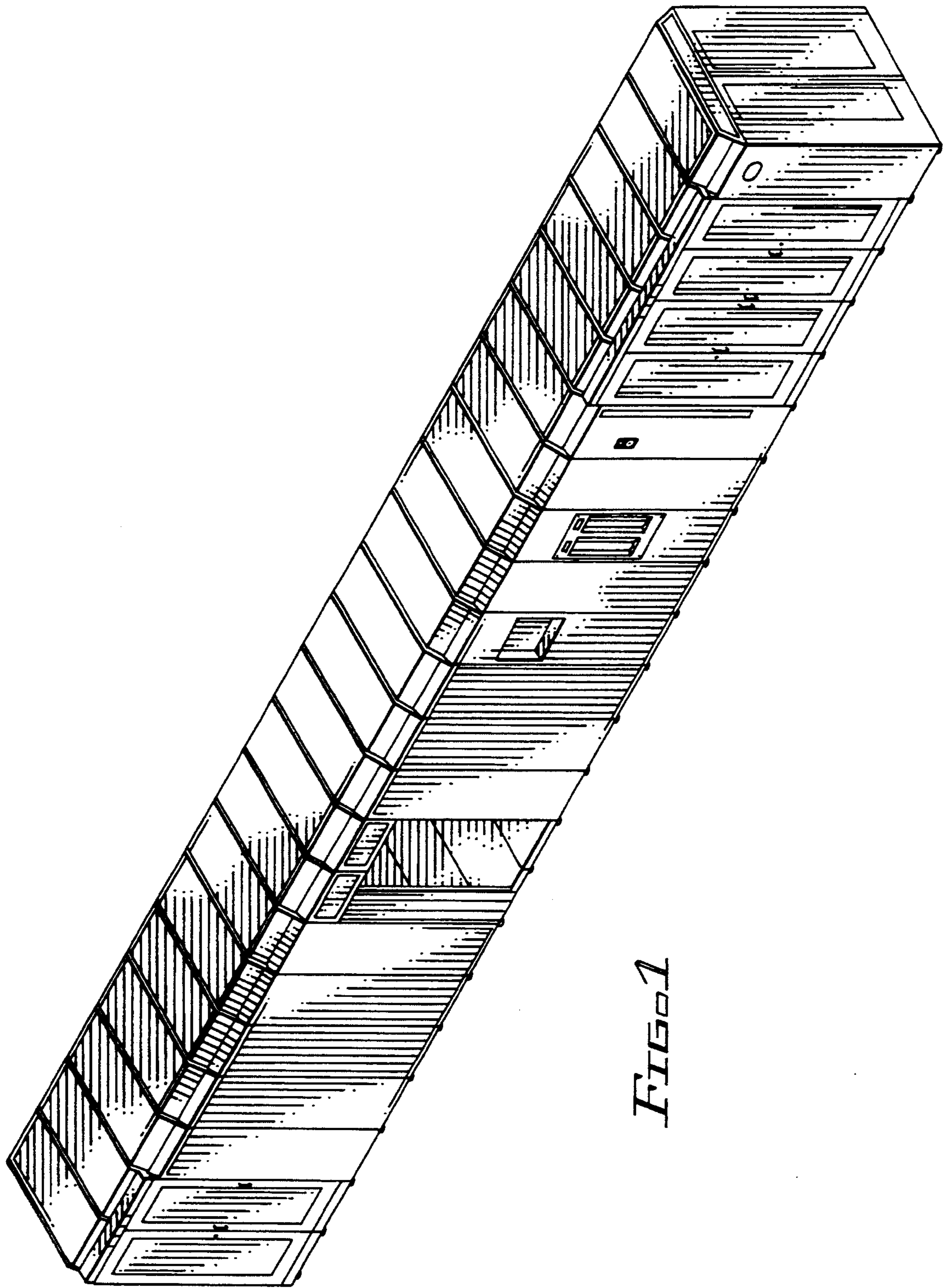

FIG 1

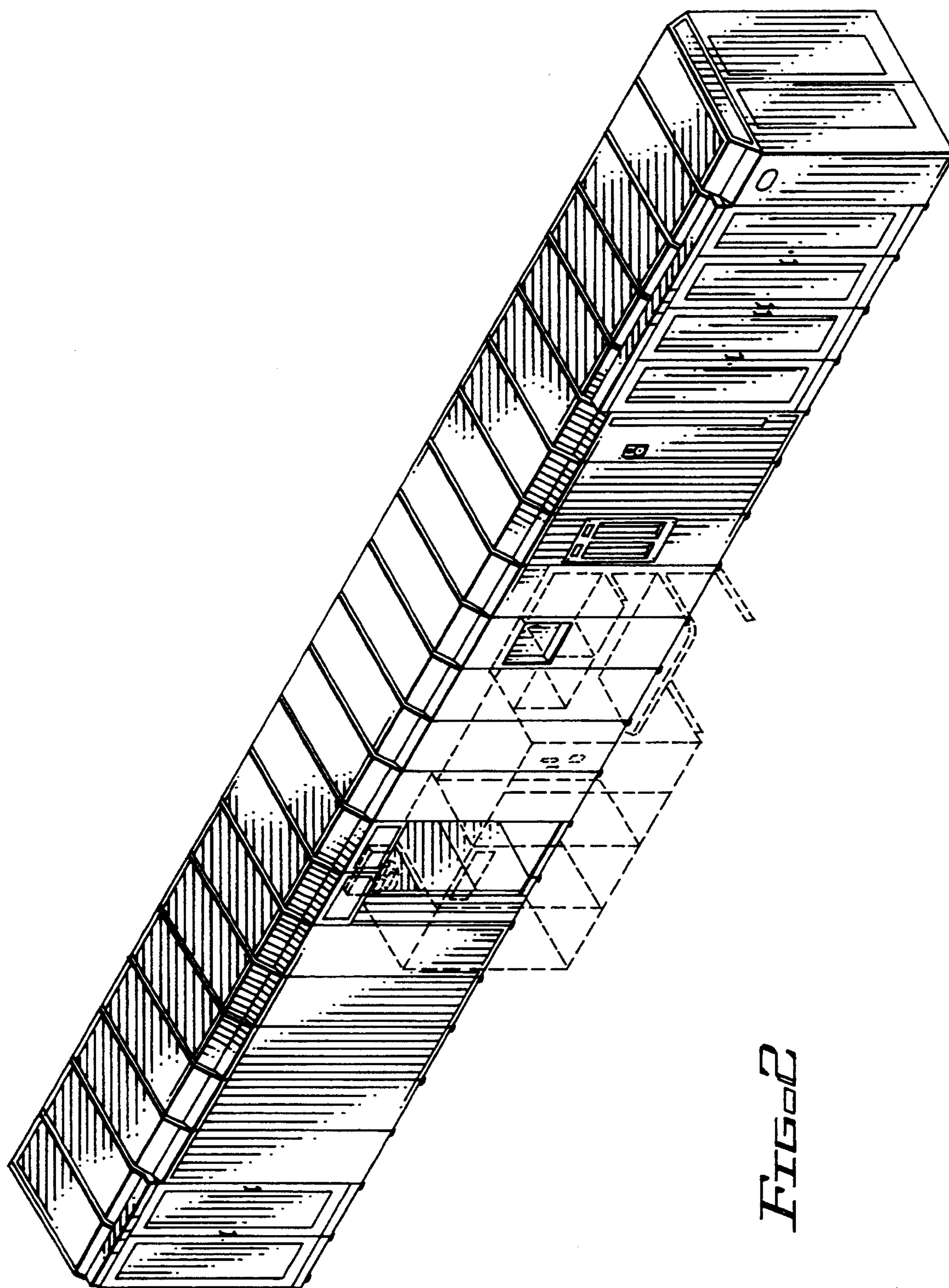

FIG. 2

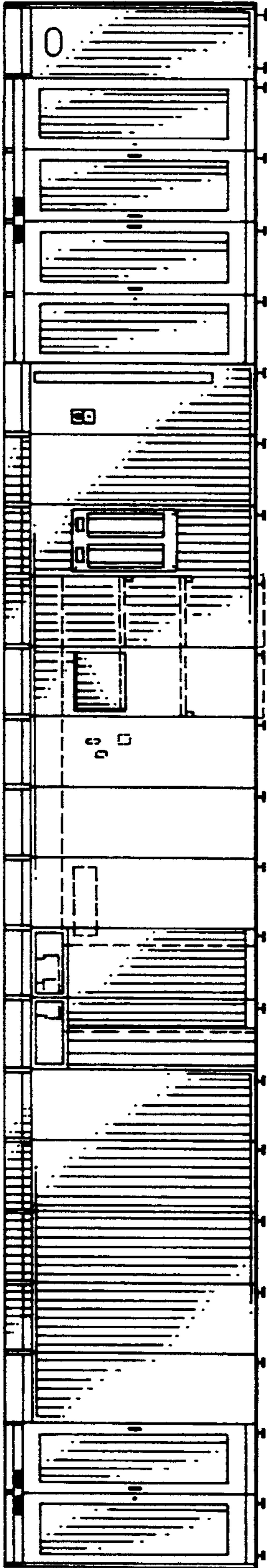

FIG 3

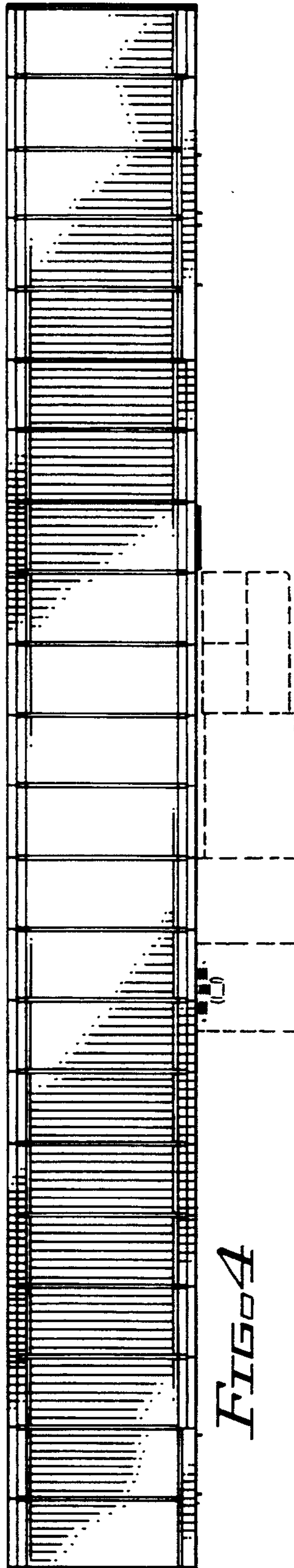

FIG 4

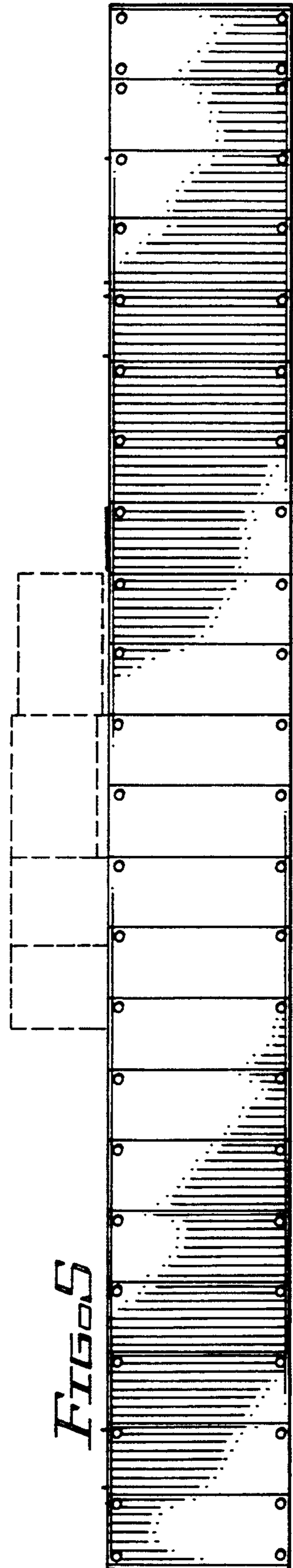

FIG 5

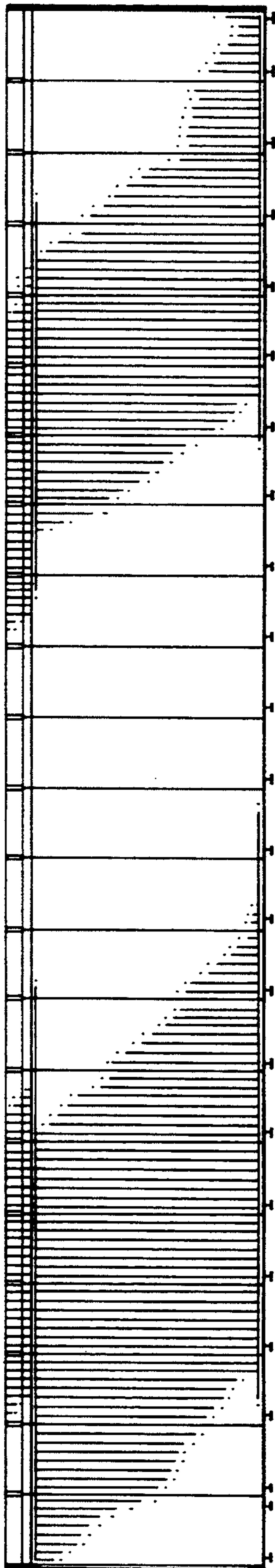

FIG. 6

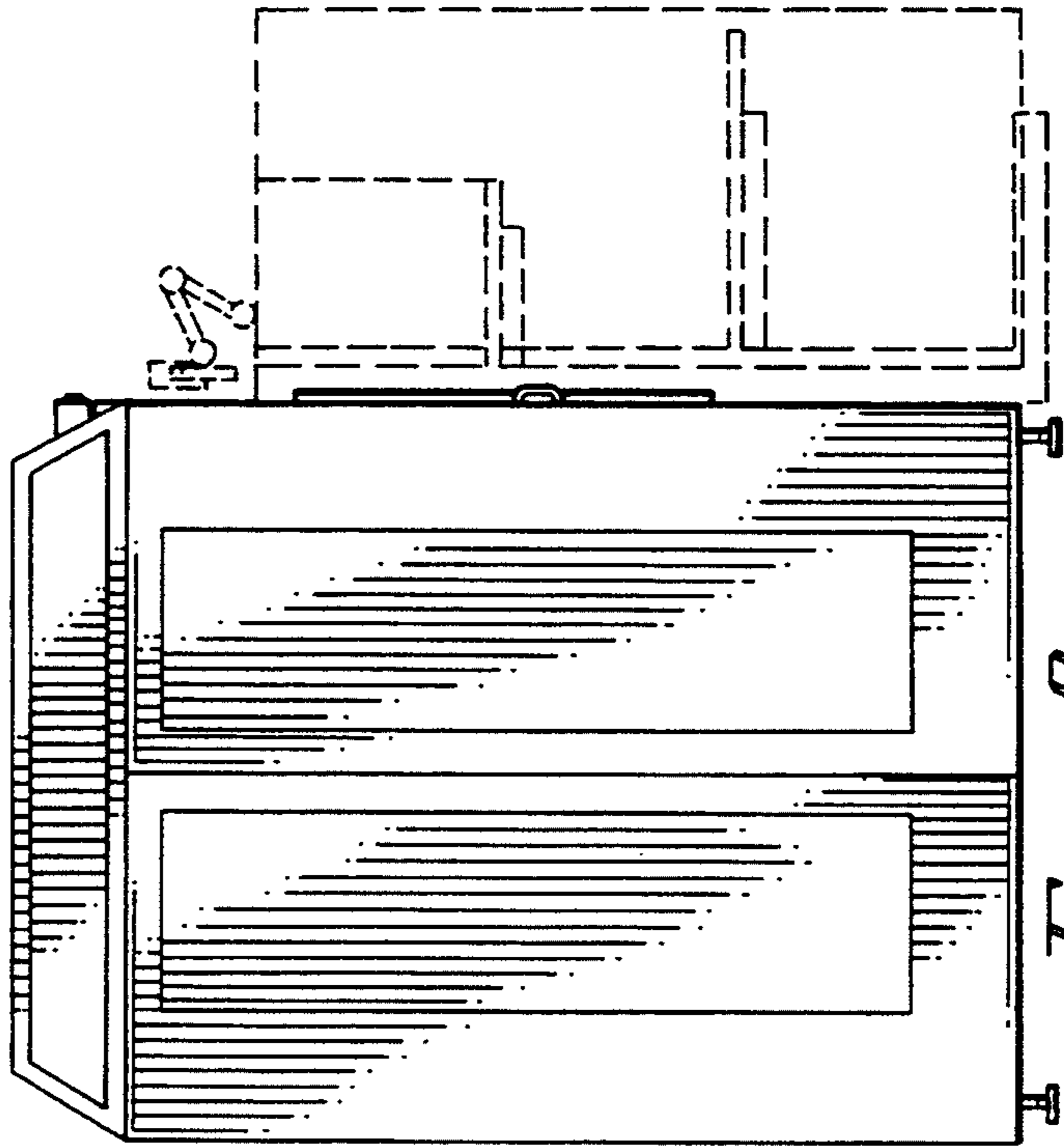

FIG. 7

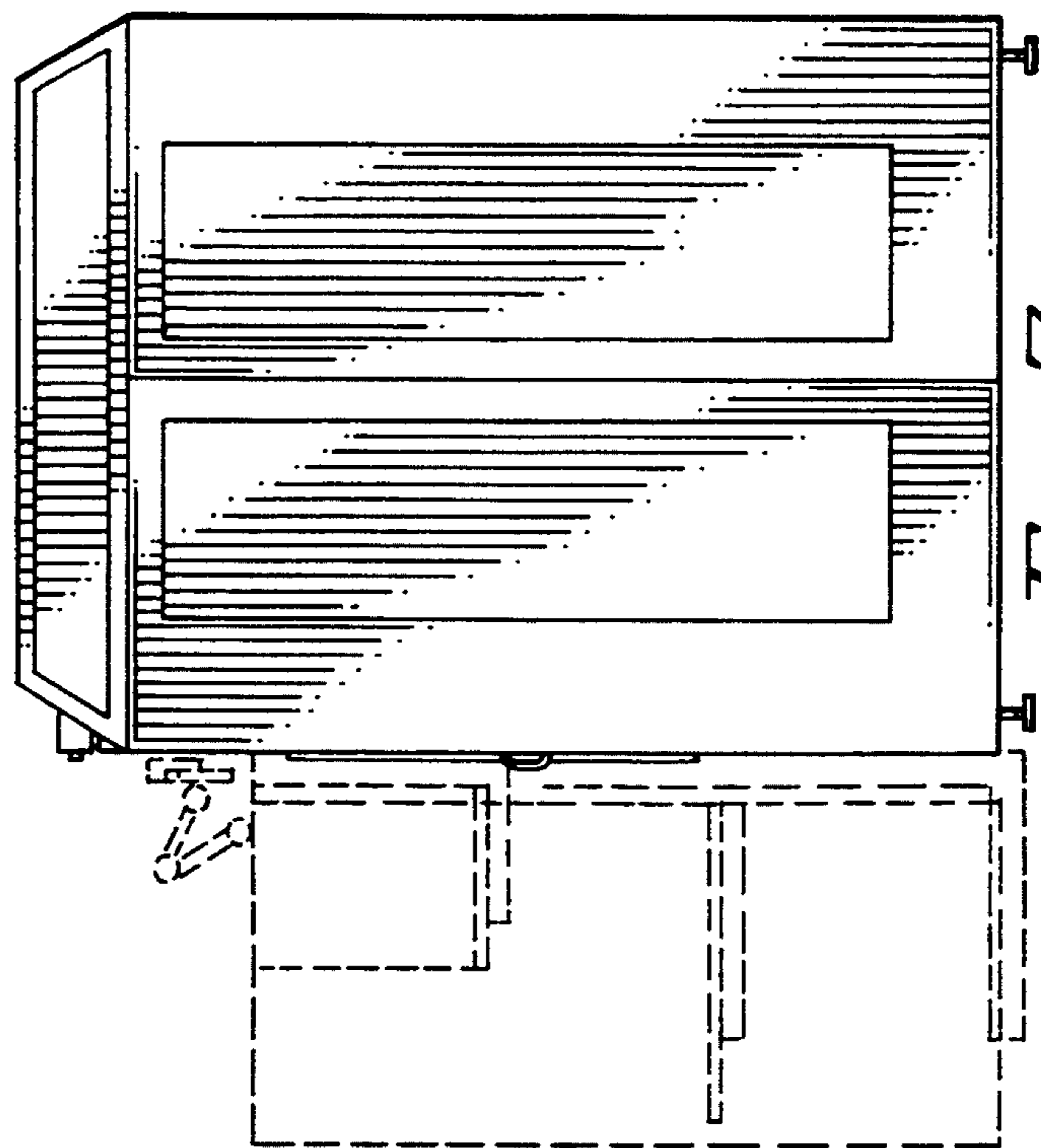

FIG. 8

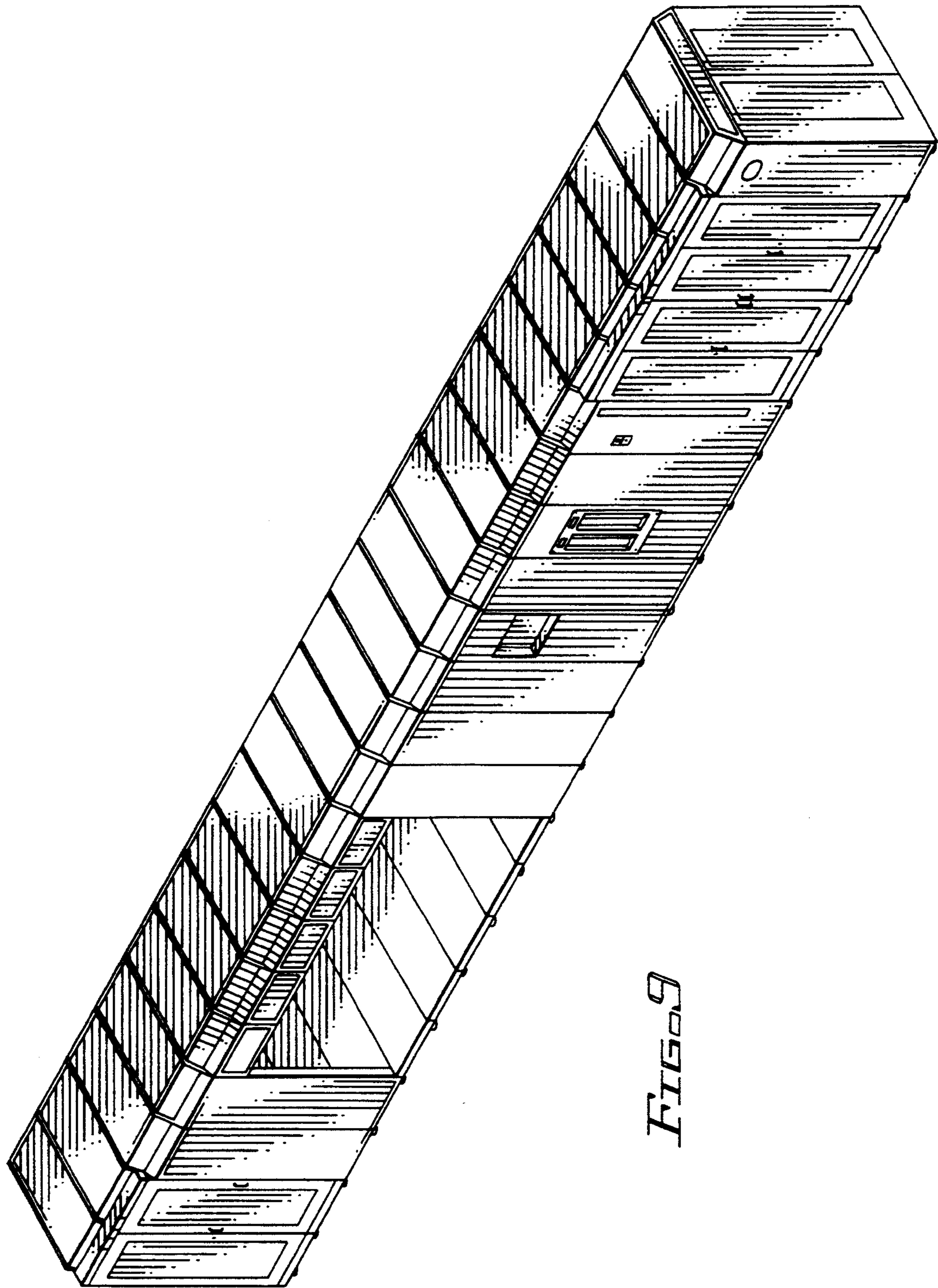

FIG. 9

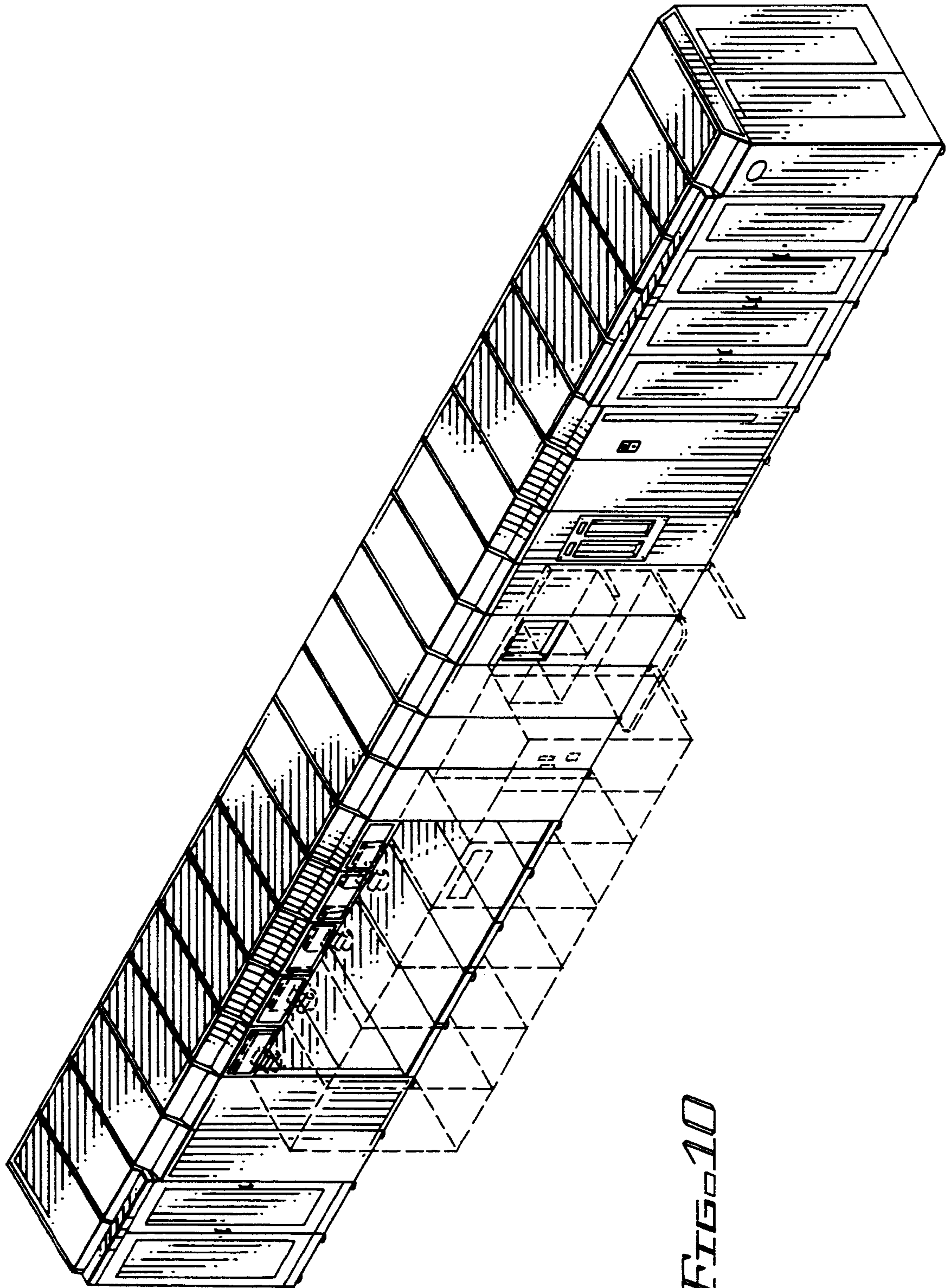

FIG. 10

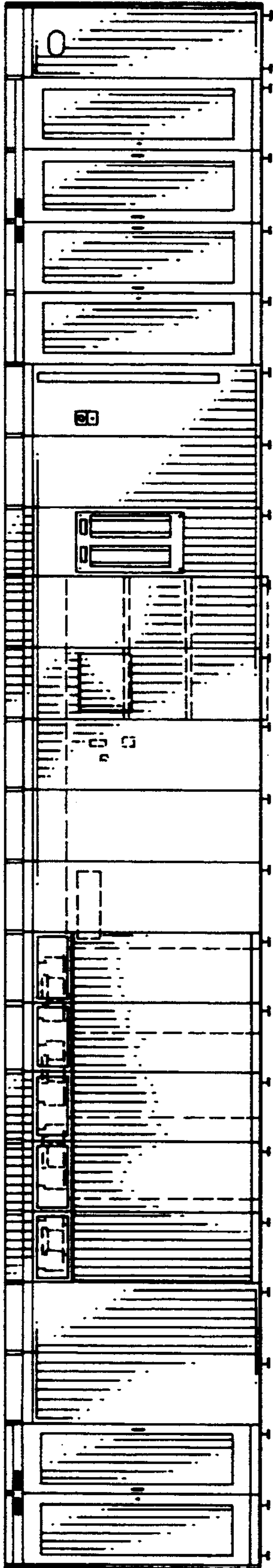

FIG. 11

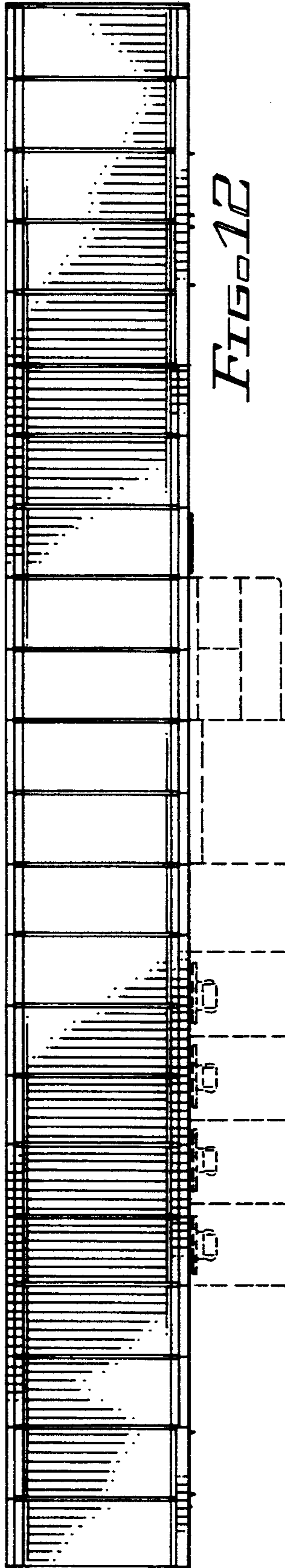

FIG. 12

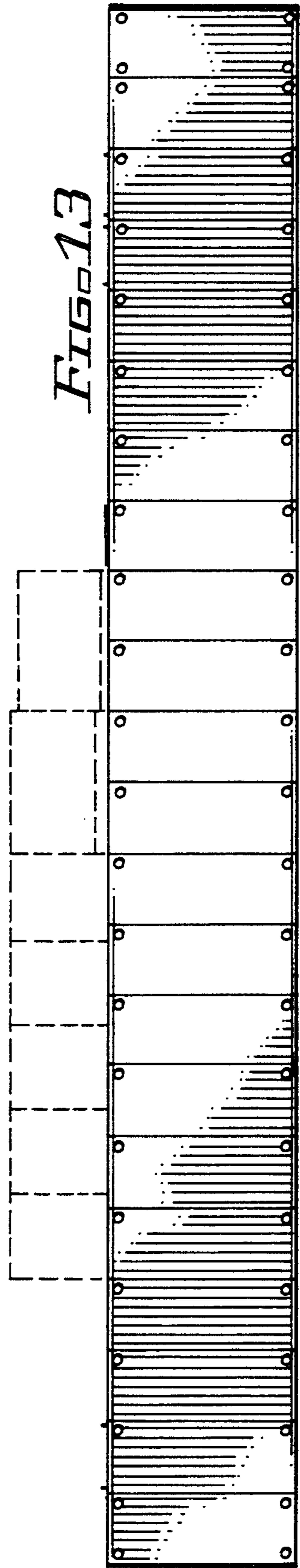

FIG. 13

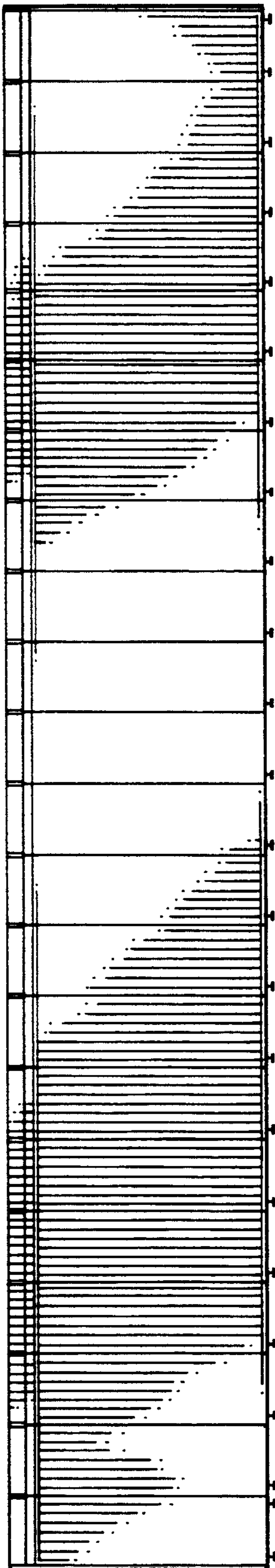

FIG. 14

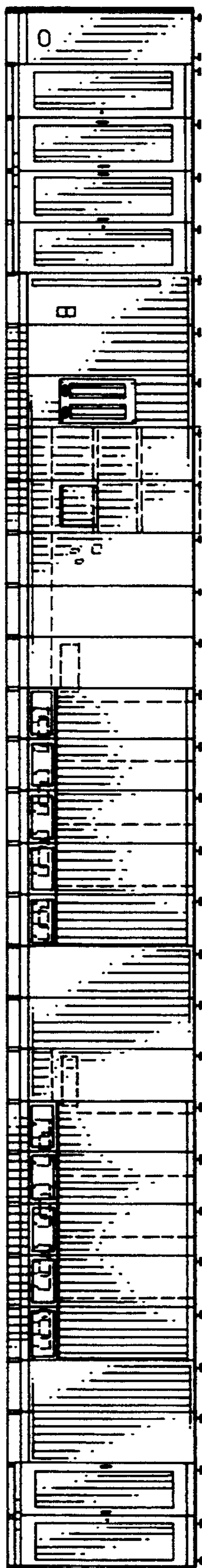

FIG. 17

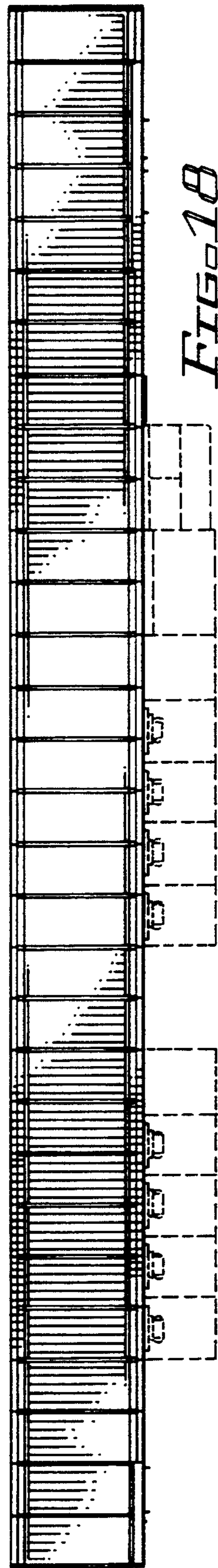

FIG. 18

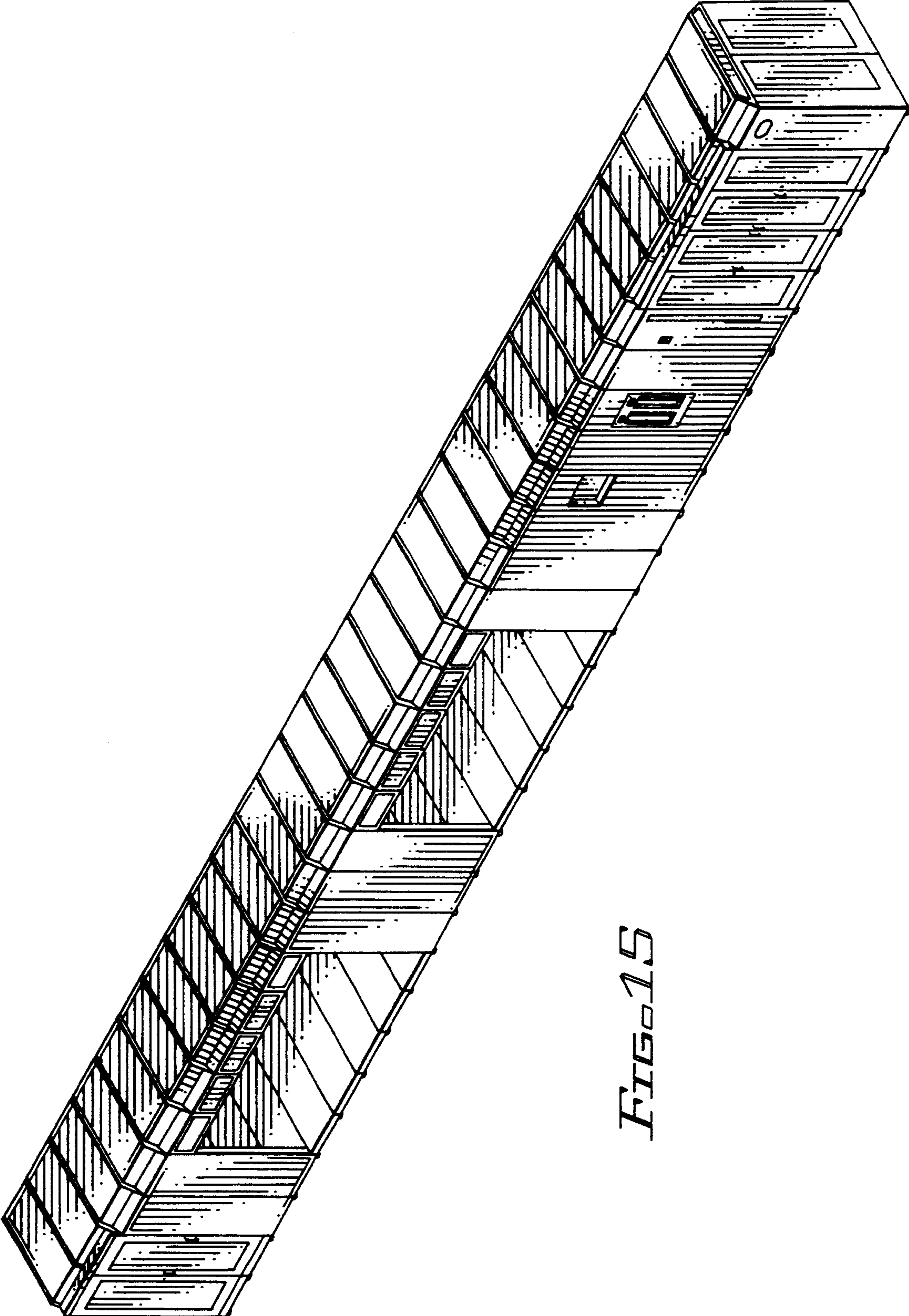

FIG. 15

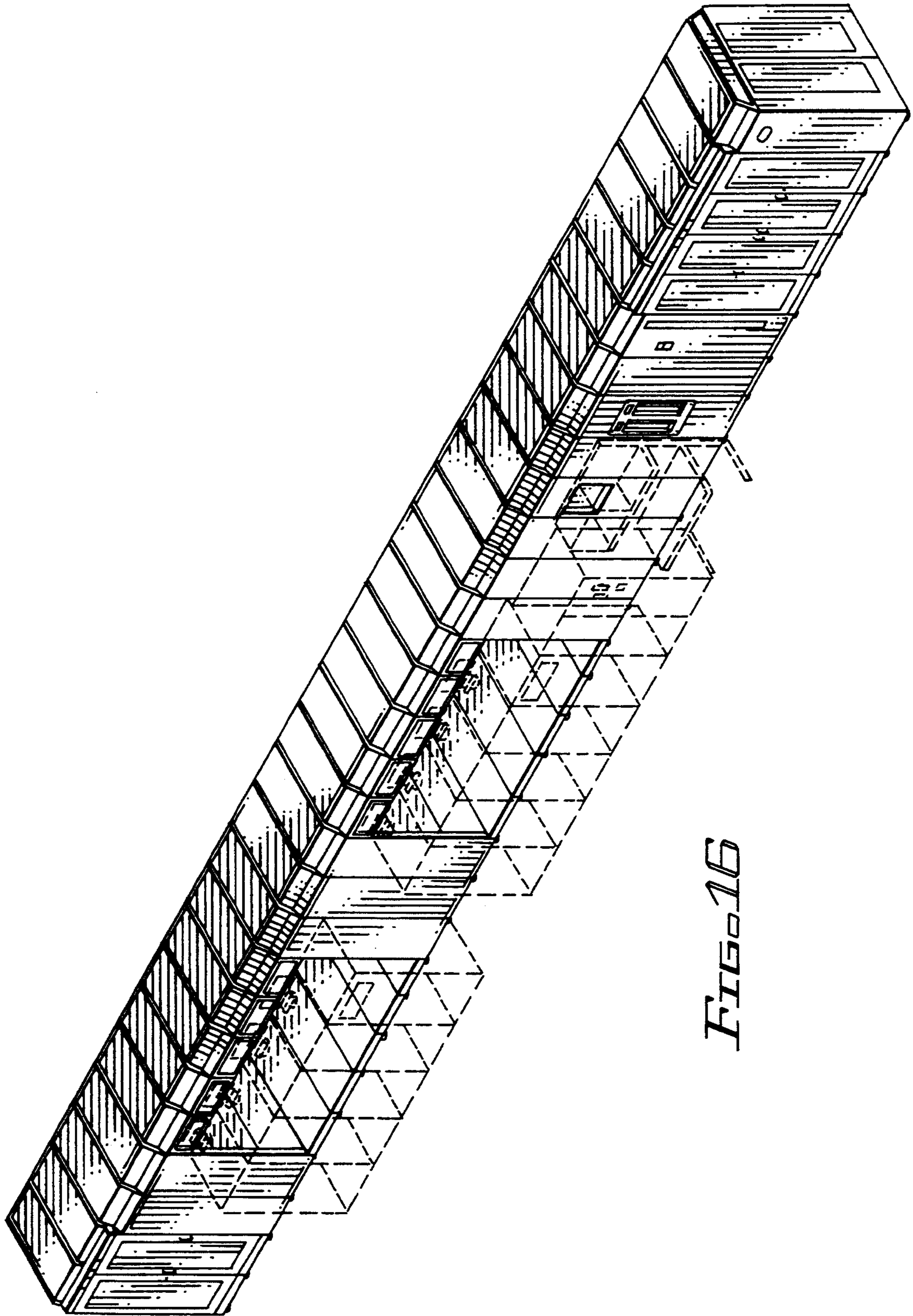

FIG. 16

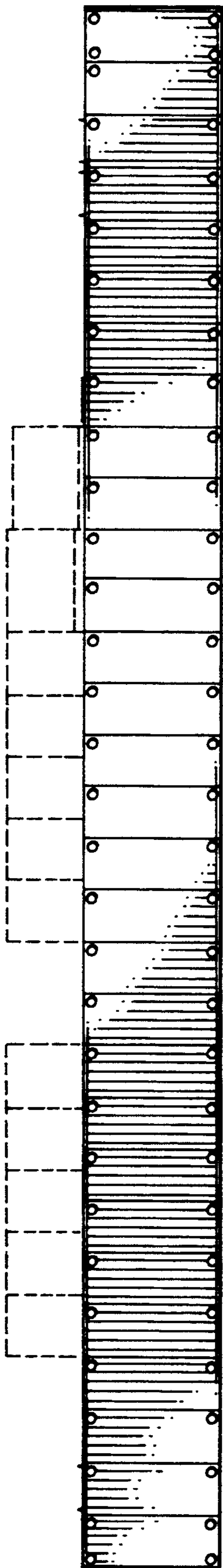

FIG. 19

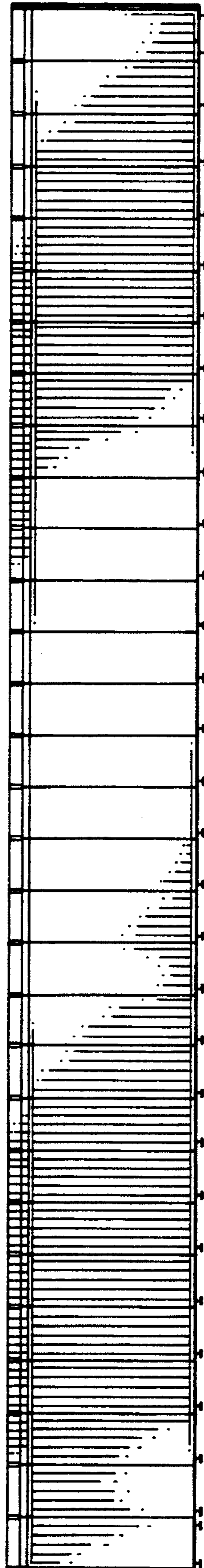

FIG. 20