



US00D351903S

# United States Patent [19]

Whitley, II

[11] Patent Number: **Des. 351,903**

[45] Date of Patent: **\*\* Oct. 25, 1994**

## [54] LOUVERED VENT FOR BOATS

[75] Inventor: **Warwick M. Whitley, II**, Lynn Haven, Fla.

[73] Assignee: **Attwood Corporation**, Lowell, Mich.

[\*\*] Term: **14 Years**

[21] Appl. No.: **12,223**

[22] Filed: **Aug. 26, 1993**

[52] U.S. Cl. .... **D23/388; D12/317; D23/387; D25/49**

[58] Field of Search ..... **454/78, 277, 82; D23/386, 392, 387, 388, 391, 389, 393, 370; D25/49, 53, 152, 156; D12/317**

## [56] References Cited

### U.S. PATENT DOCUMENTS

D. 290,744	7/1987	Whitley, II	.....	D23/388
D. 290,745	7/1987	Whitley, II	.....	D23/388
D. 290,746	7/1987	Whitley, II	.....	D23/388
D. 291,592	8/1987	Flowers	.....	D23/388
4,712,501	12/1987	Whitley, II	.....	454/78

## OTHER PUBLICATIONS

Attwood Product Catalog 1991-1992, pp. 19, 20, and 21.

Attwood Product Catalog 1985-1986, p. 63.

Attwood Product Catalog 1992-1993, pp. 21, 22, 23, and 24.

*Primary Examiner*—Lisa P. Lichtenstein

*Attorney, Agent, or Firm*—Price, Heneveld, Cooper, DeWitt & Litton

## [57] CLAIM

The ornamental design for a louvered vent for boats, as shown and described.

## DESCRIPTION

FIG. 1 is a top perspective view of a louvered vent for boats, showing my new design;

FIG. 2 is a top plan view thereof;

FIG. 3 is one side-elevational view thereof;

FIG. 4 is the other side-elevational view thereof;

FIG. 5 is a bottom plan view thereof;

FIG. 6 is a cross-sectional view taken along line 6—6 of FIG. 2;

FIG. 7 is a cross-sectional view taken along line 7—7 of FIG. 2; and,

FIG. 8 is a right end elevational view thereof, the left end being a mirror image.

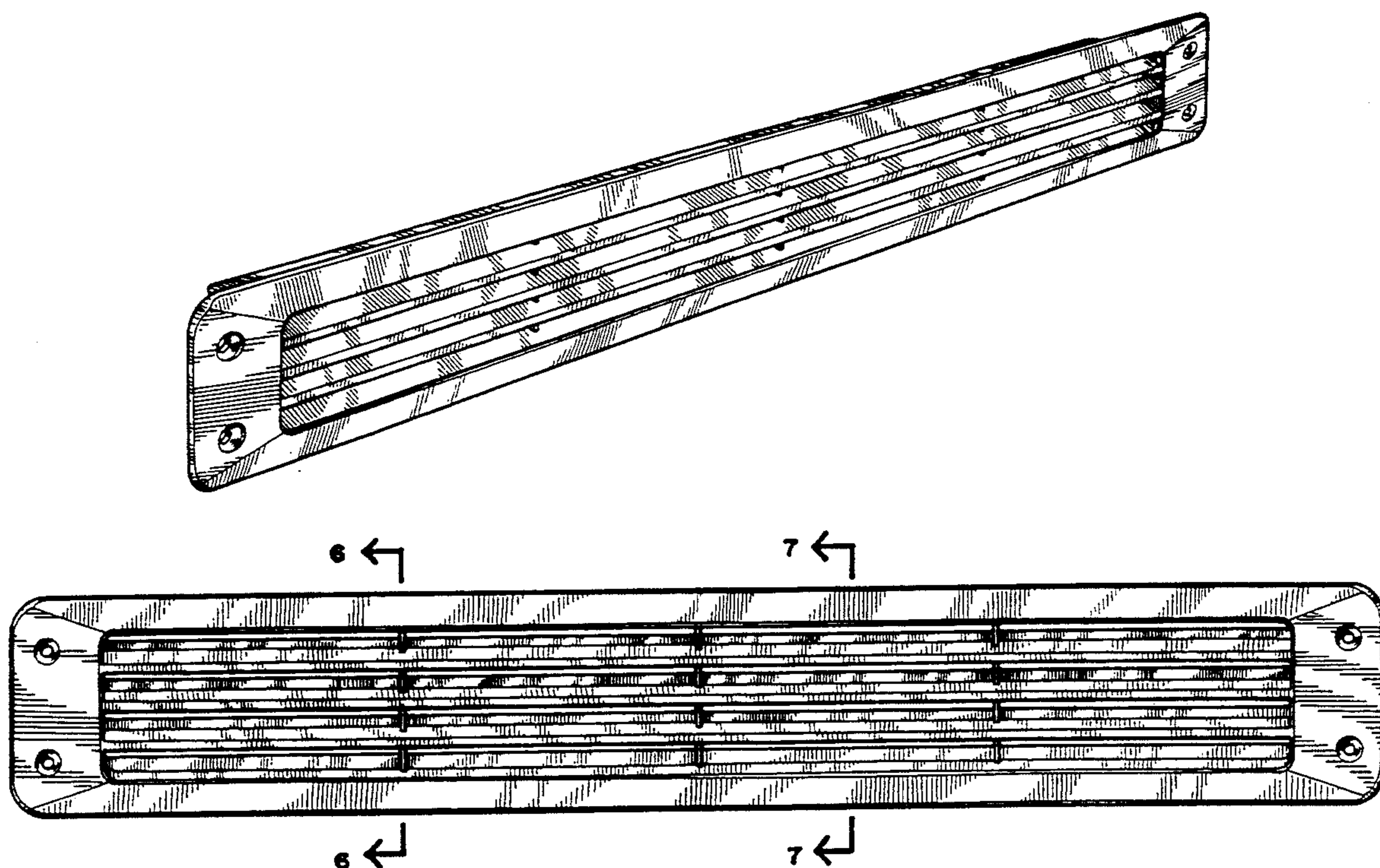

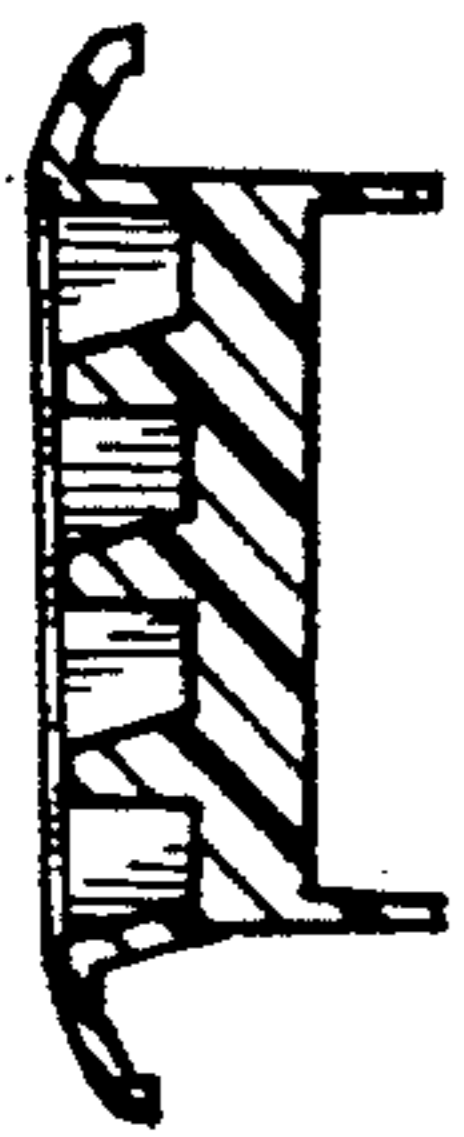

FIG. 6

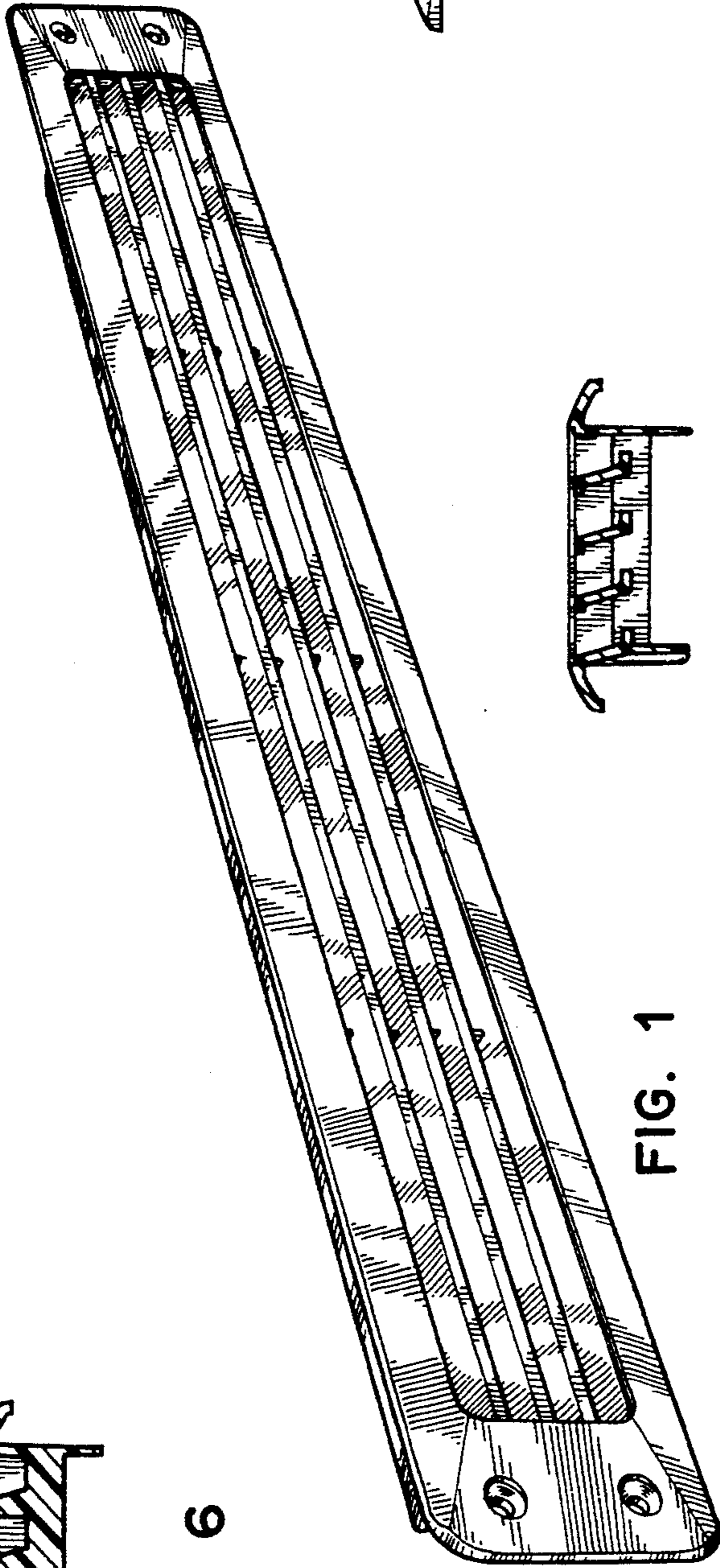

FIG. 1

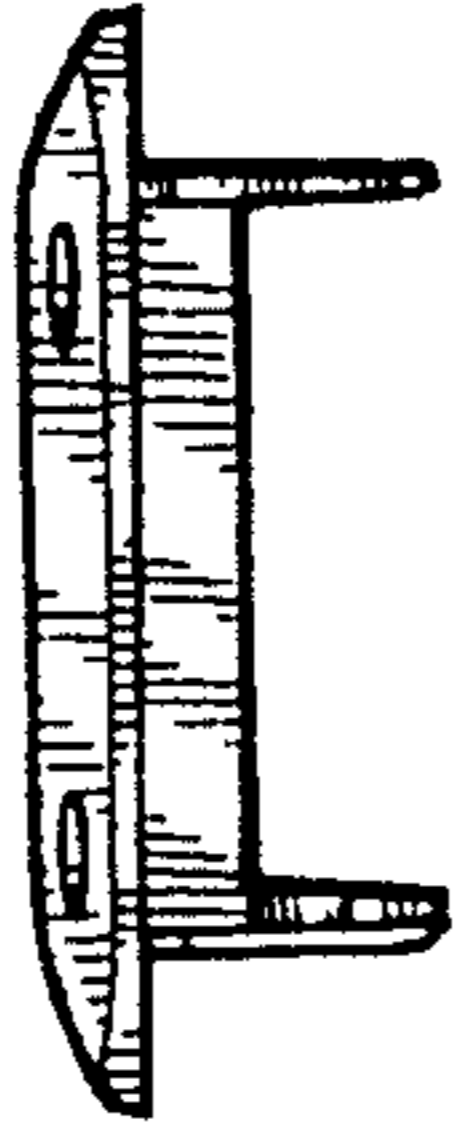

FIG. 8

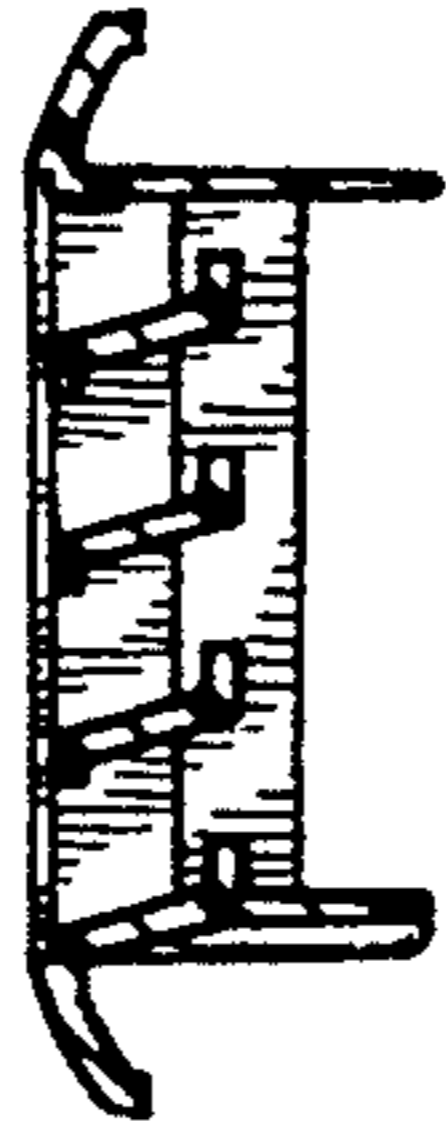

FIG. 7

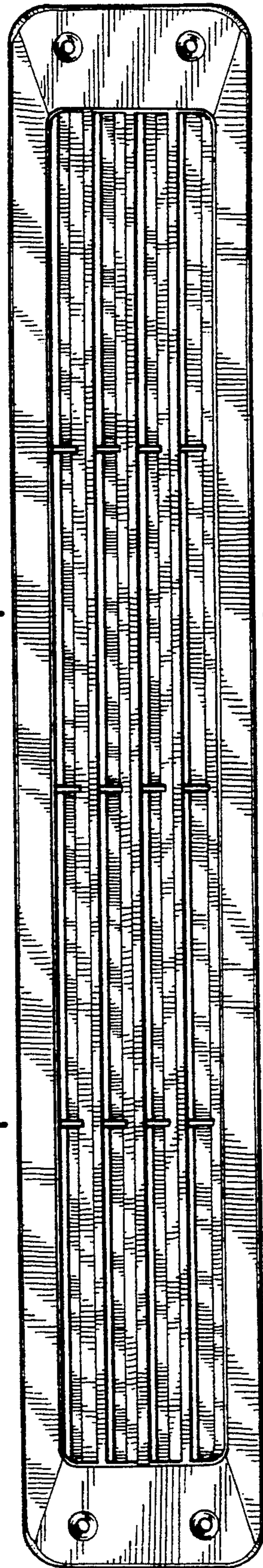

FIG. 2



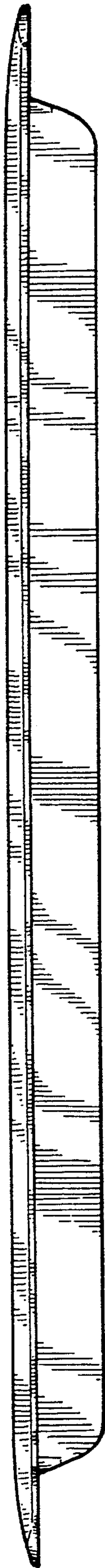

FIG. 3

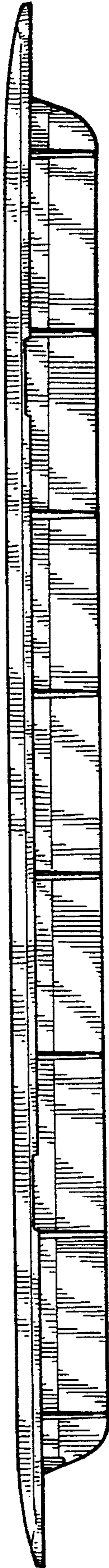

FIG. 4

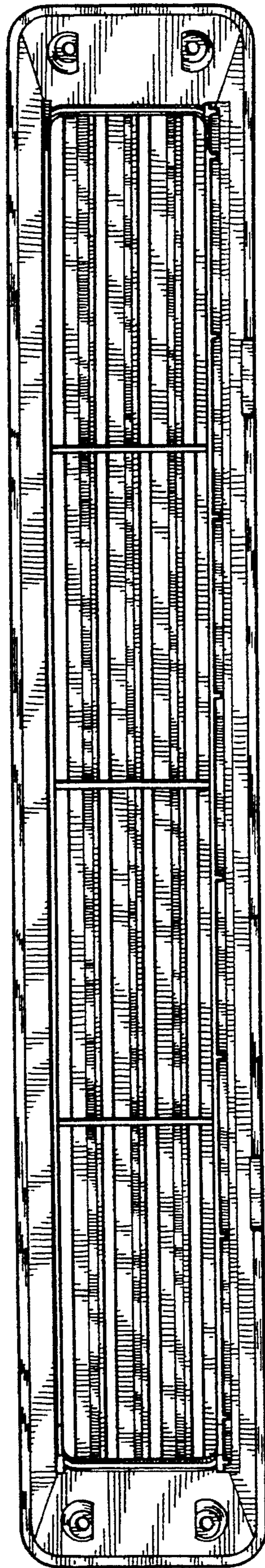

FIG. 5