



US00D351713S

United States Patent [19]

[11] Patent Number: **Des. 351,713**

Smotrycz et al.

[45] Date of Patent: **** Oct. 25, 1994**

[54] TREKKING SANDAL

[75] Inventors: **Zenon O. Smotrycz**, Reading;
Edward Norton, Boxford, both of
Mass.

[73] Assignee: **Der-Tex Corporation**, Lawrence,
Mass.

[**] Term: **14 Years**

[21] Appl. No.: **10,339**

[22] Filed: **Jul. 2, 1993**

[52] U.S. Cl. **D2/916; D2/959**

[58] Field of Search **D2/896, 951, 916-918,**
D2/959, 960; 36/10, 11.5, 132, 136

[56] References Cited

U.S. PATENT DOCUMENTS

D. 80,039	12/1929	Mathews .	
D. 278,092	3/1985	Gamm	D2/918
D. 324,764	3/1992	Allen	D2/959
D. 330,801	11/1992	McDonald	D2/959
2,072,785	3/1937	Wulff	36/11.5
2,096,269	10/1937	Willman	36/11.5
2,220,534	11/1940	McLean	36/11.5
2,390,416	12/1945	Bettmann	36/144
2,404,083	7/1946	Murray .	
2,505,076	4/1950	West et al.	36/11.5
2,507,120	5/1950	Shapiro	36/11.5
2,780,013	2/1957	Voss .	
4,300,294	11/1981	Riecken	36/11.5 X
4,766,681	8/1988	O'Rourke	36/11.5 X
5,014,448	5/1991	Perrone	36/11.5 X
5,088,481	2/1992	Darby	36/11.5 X

FOREIGN PATENT DOCUMENTS

2078490 1/1982 United Kingdom 36/11.5

Primary Examiner—Louis S. Zarfes

Attorney, Agent, or Firm—Fish & Richardson

[57] CLAIM

The ornamental design for a trekking sandal, as shown and described.

DESCRIPTION

FIG. 1 is a perspective view of one embodiment of a trekking sandal of the invention;
 FIG. 2 is a first side view of the trekking sandal of FIG. 1;
 FIG. 3 is an opposite side view of the trekking sandal of FIG. 1;
 FIG. 4 is a top view of the trekking sandal of FIG. 1;
 FIG. 5 is a bottom view of the trekking sandal of FIG. 1;
 FIG. 6 is a front view of the trekking sandal of FIG. 1;
 FIG. 7 is a rear view of the trekking sandal of FIG. 1;
 FIG. 8 is a perspective view of another embodiment of a trekking sandal of the invention;
 FIG. 9 is a first side view of the trekking sandal of FIG. 8;
 FIG. 10 is an opposite side view of the trekking sandal of FIG. 8;
 FIG. 11 is a top view of the trekking sandal of FIG. 8;
 FIG. 12 is a bottom view of the trekking sandal of FIG. 8;
 FIG. 13 is a front view of the trekking sandal of FIG. 8;
 and,
 FIG. 14 is a rear view of the trekking sandal of FIG. 8.

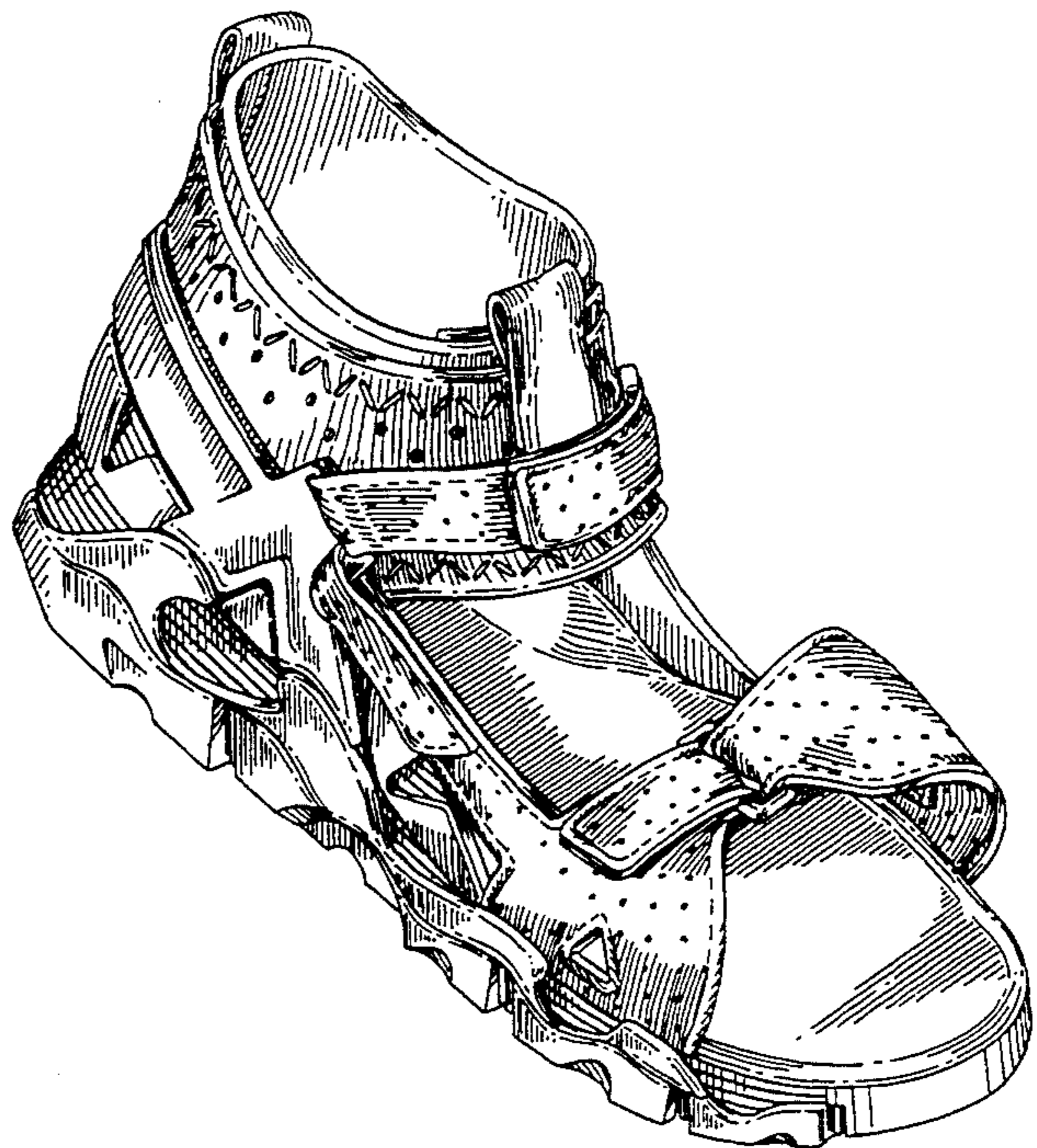



FIG. 1

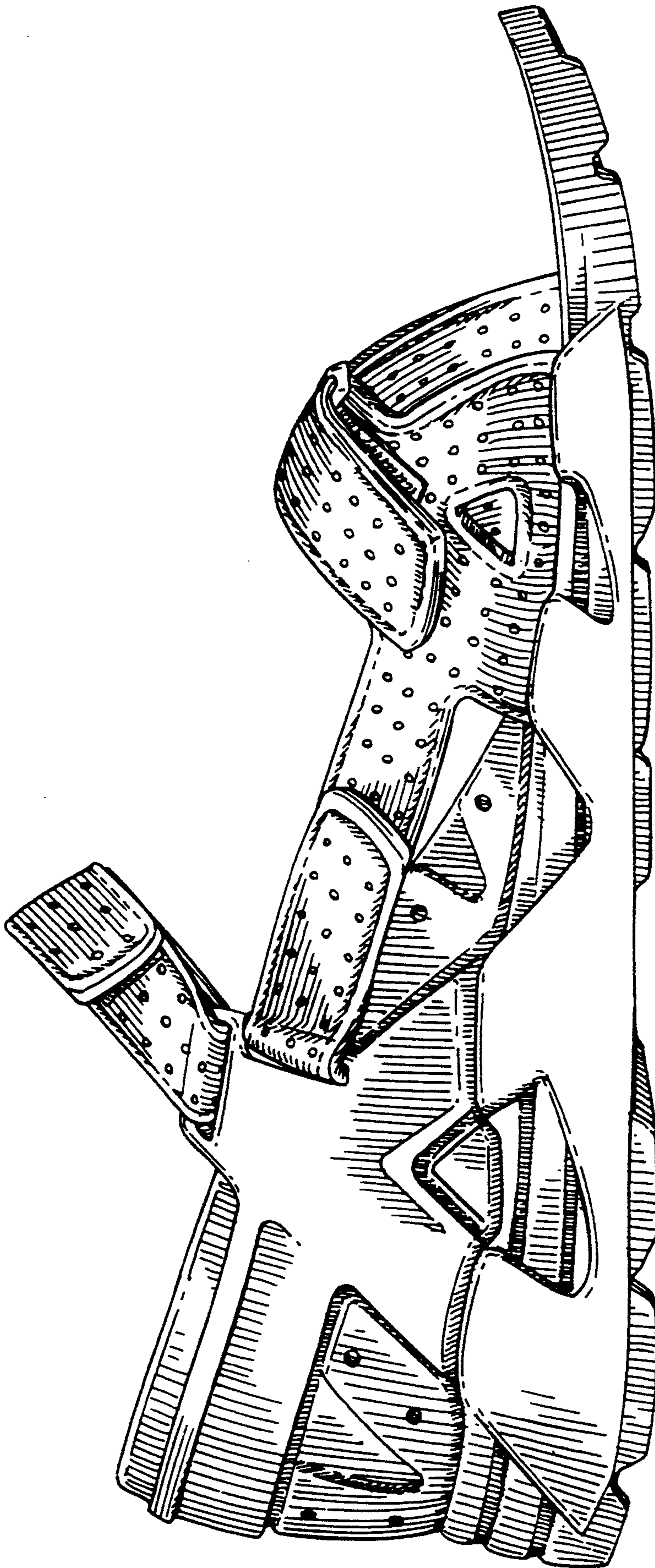

FIG. 2

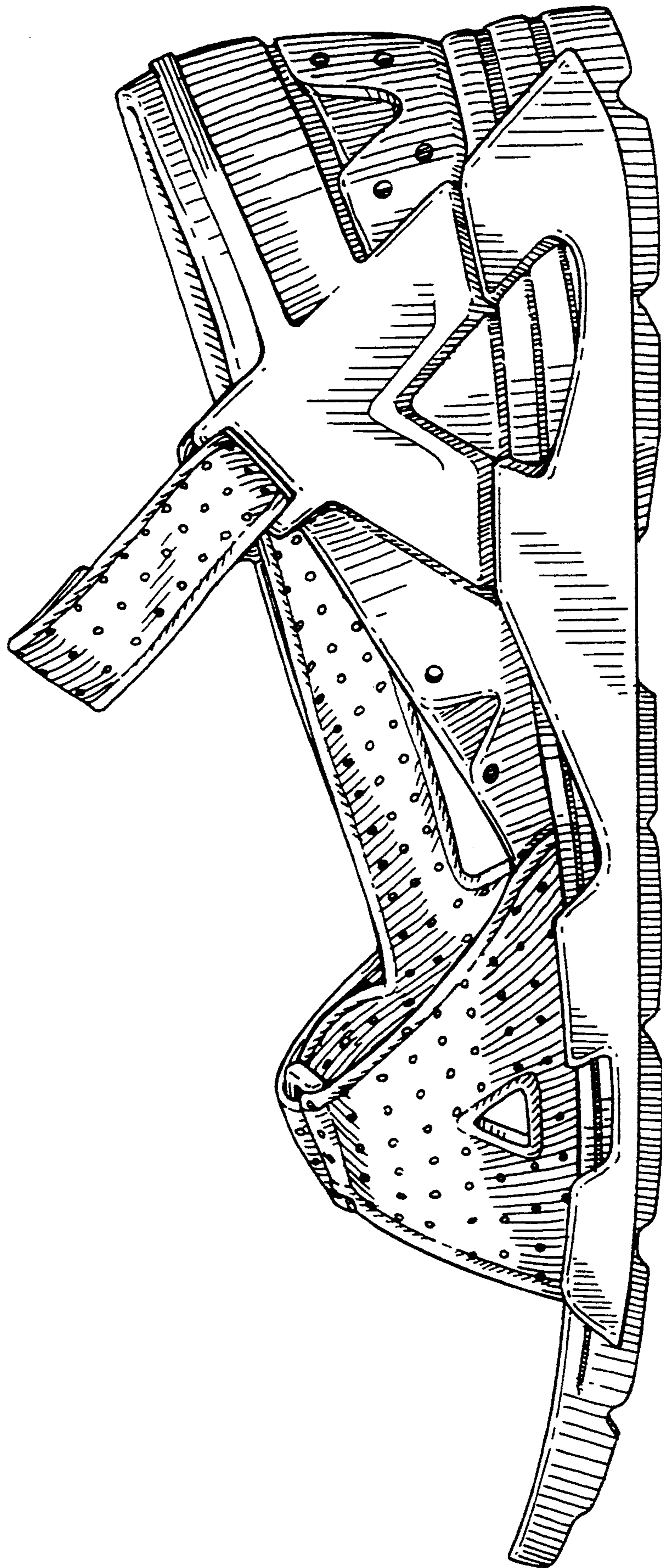

FIG. 3

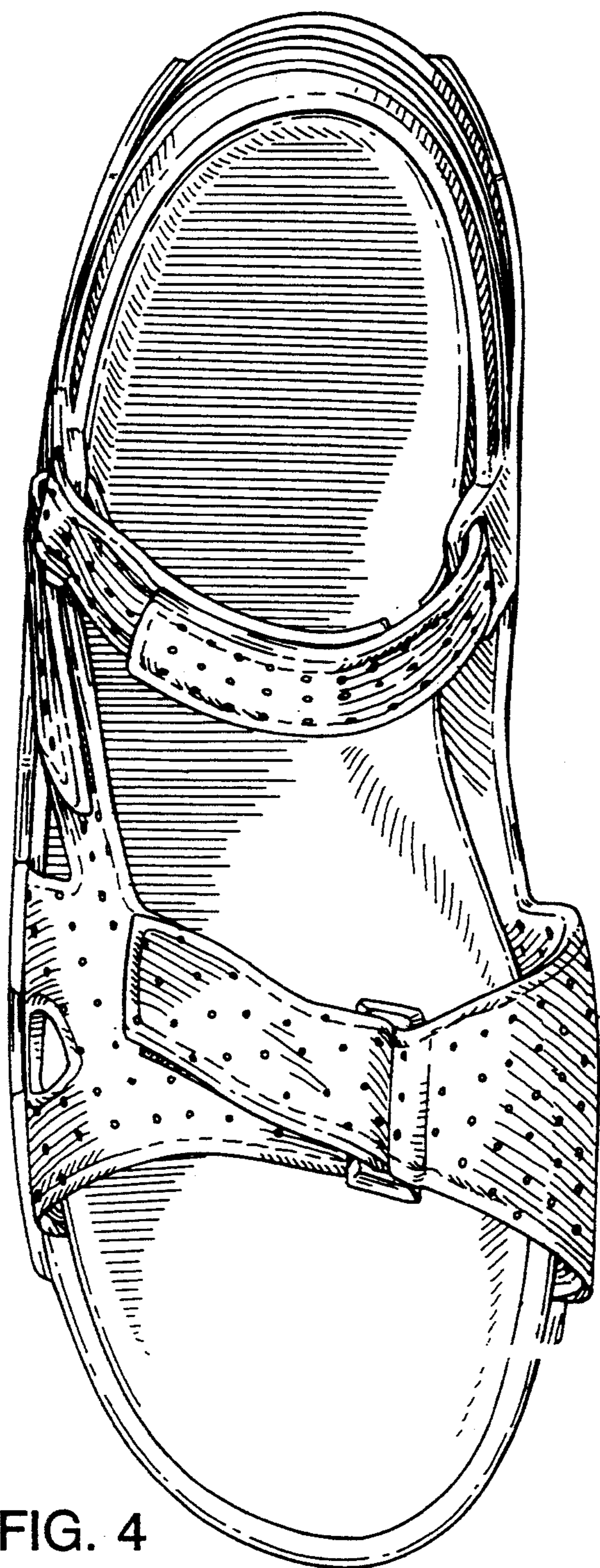

FIG. 4

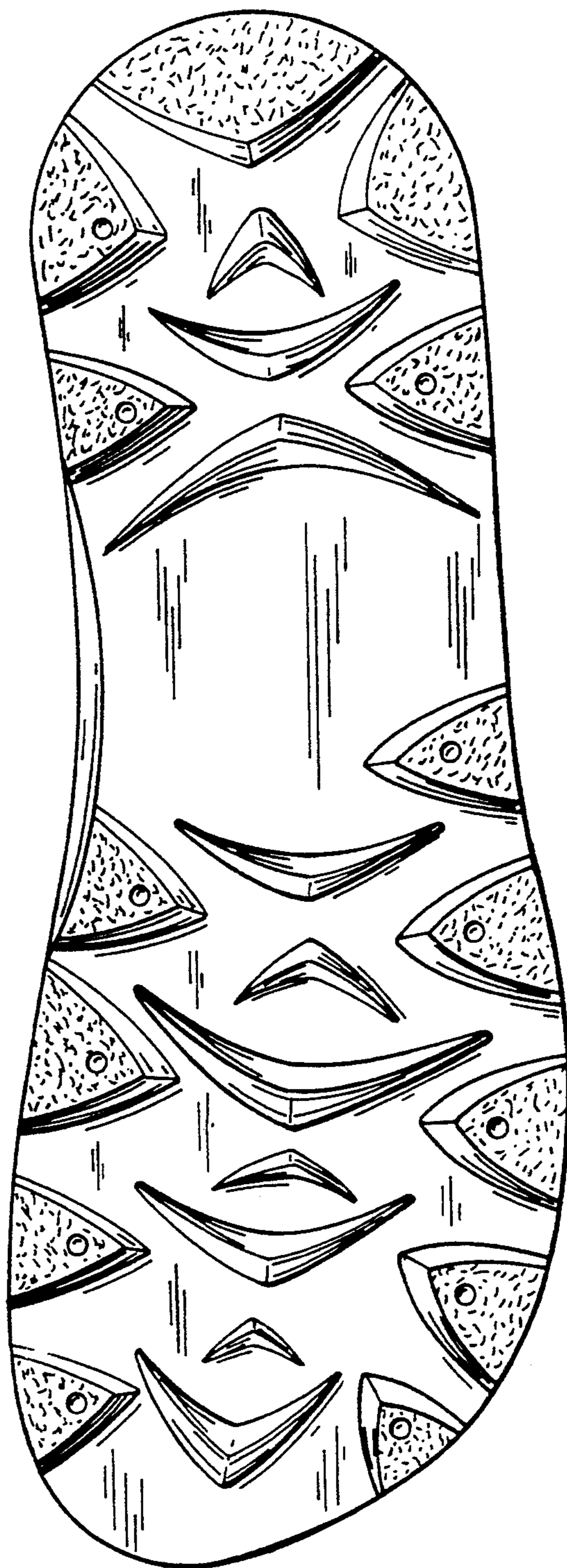

FIG. 5

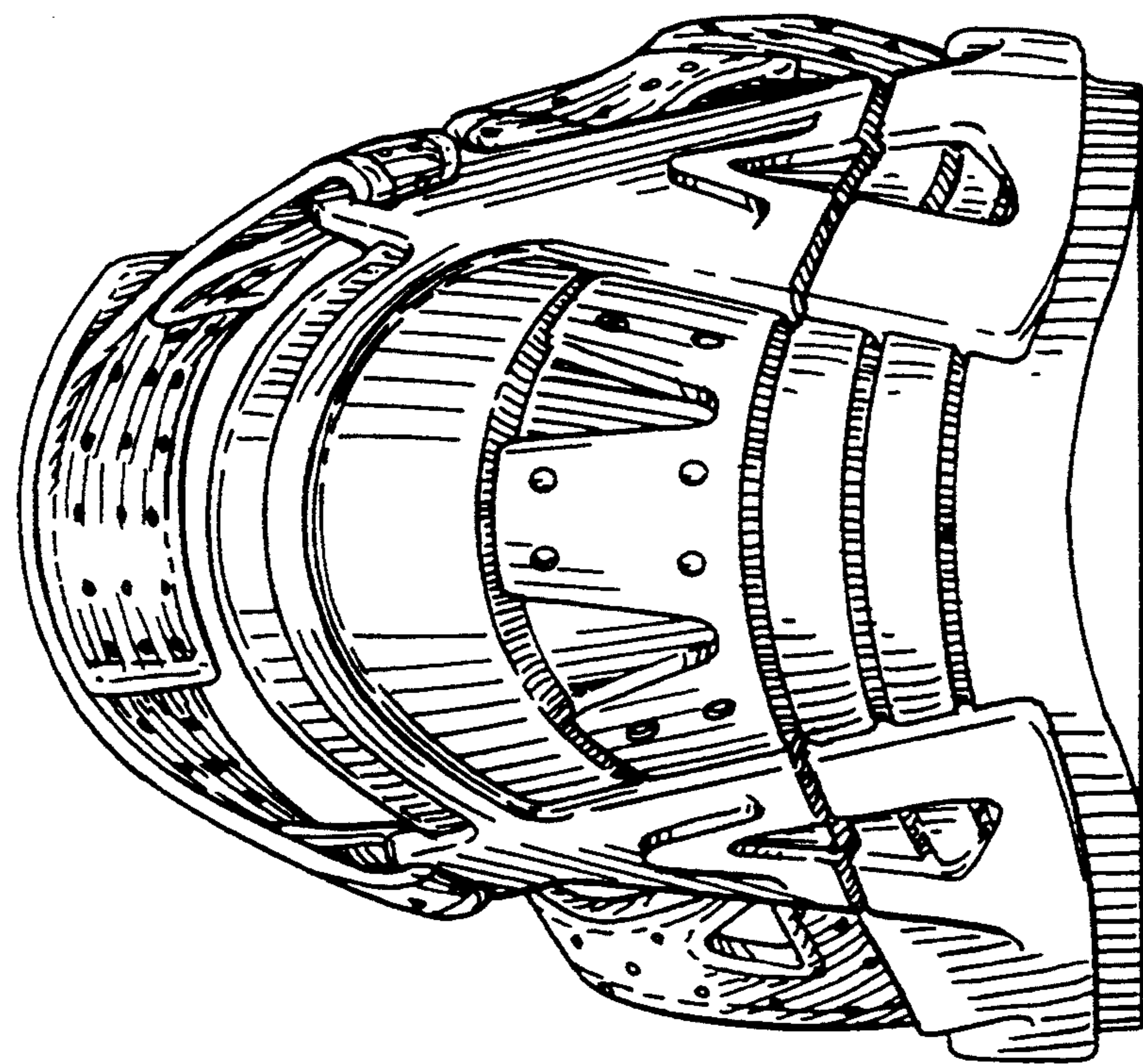

FIG. 7

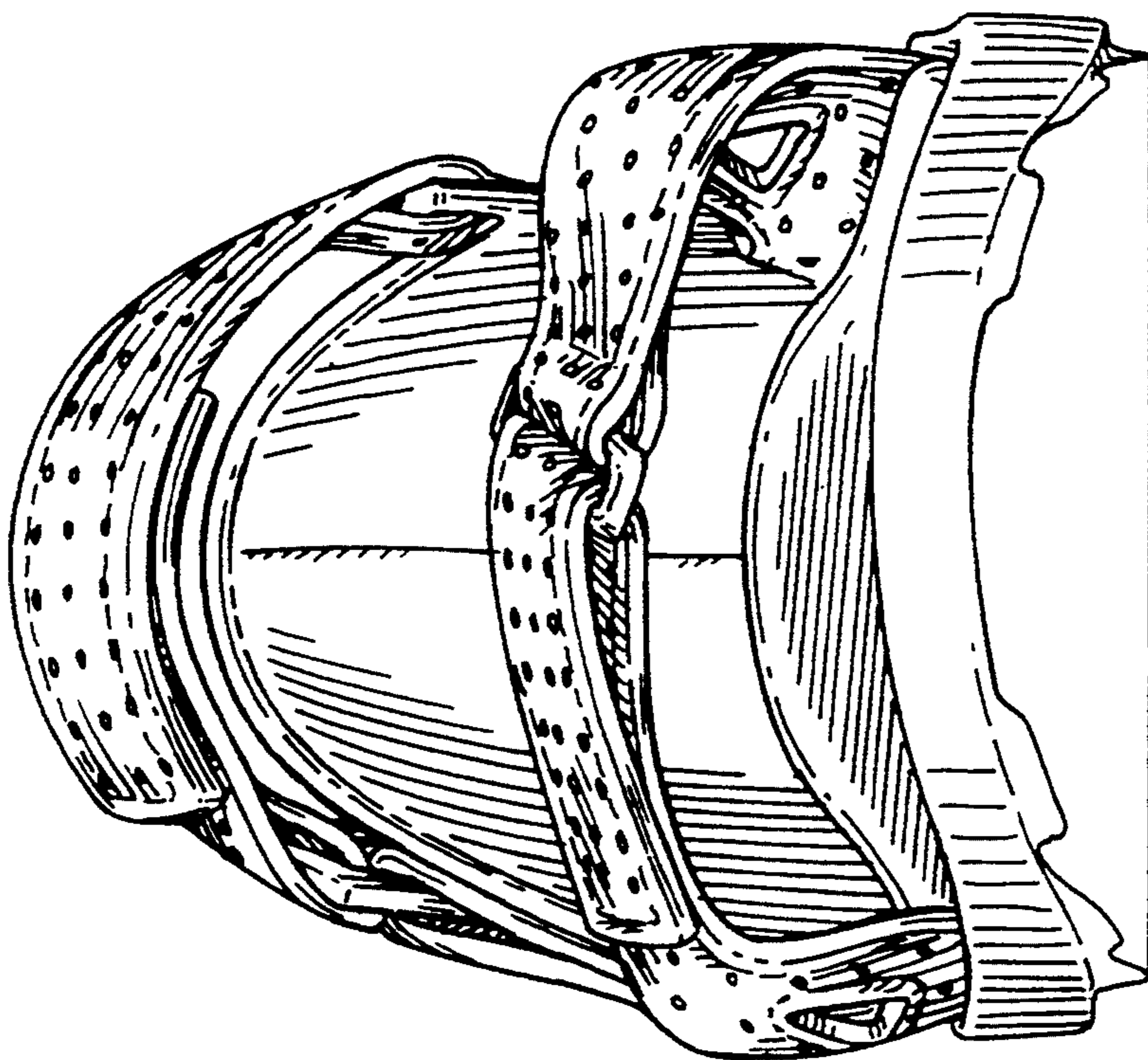

FIG. 6

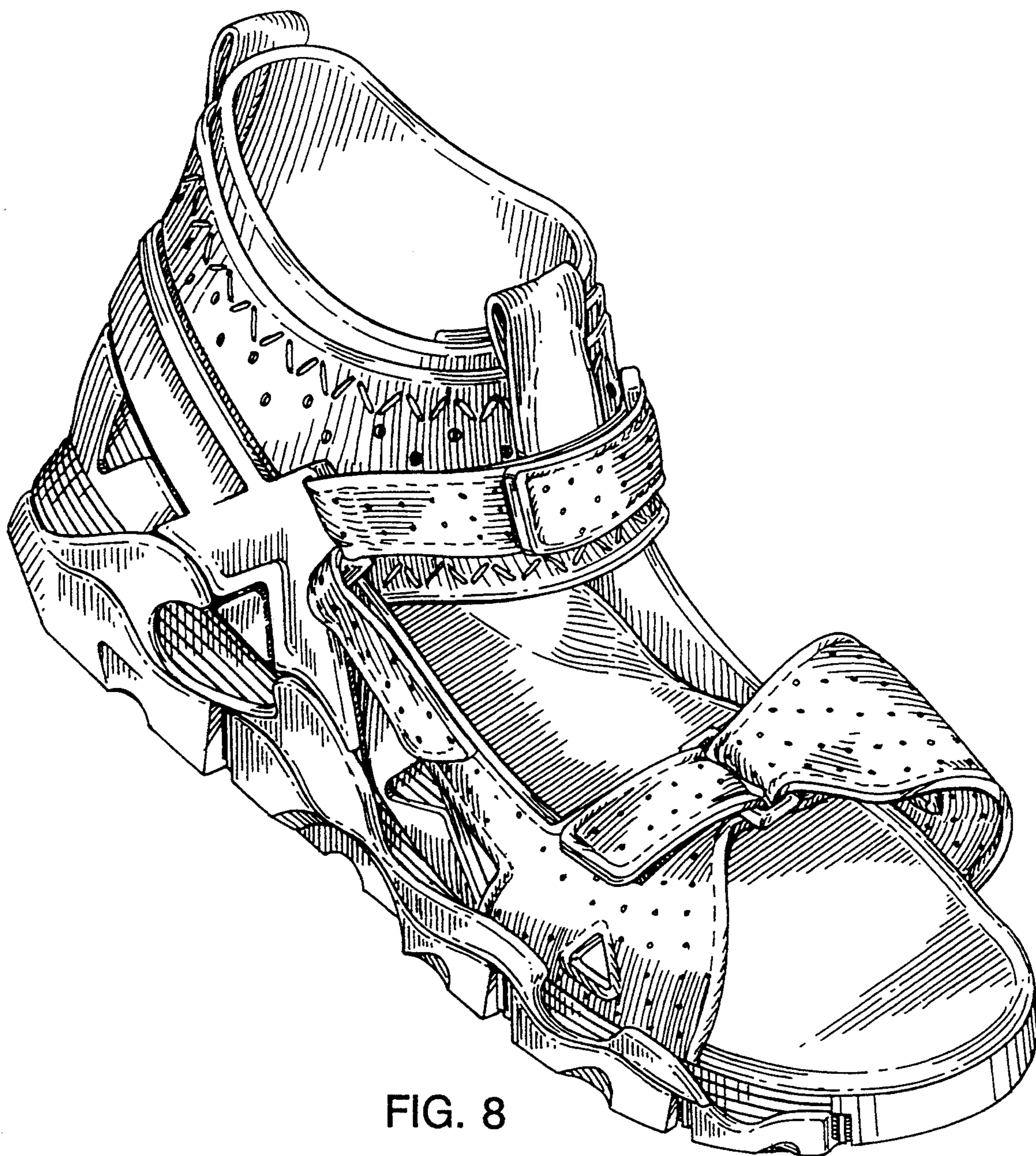

FIG. 8

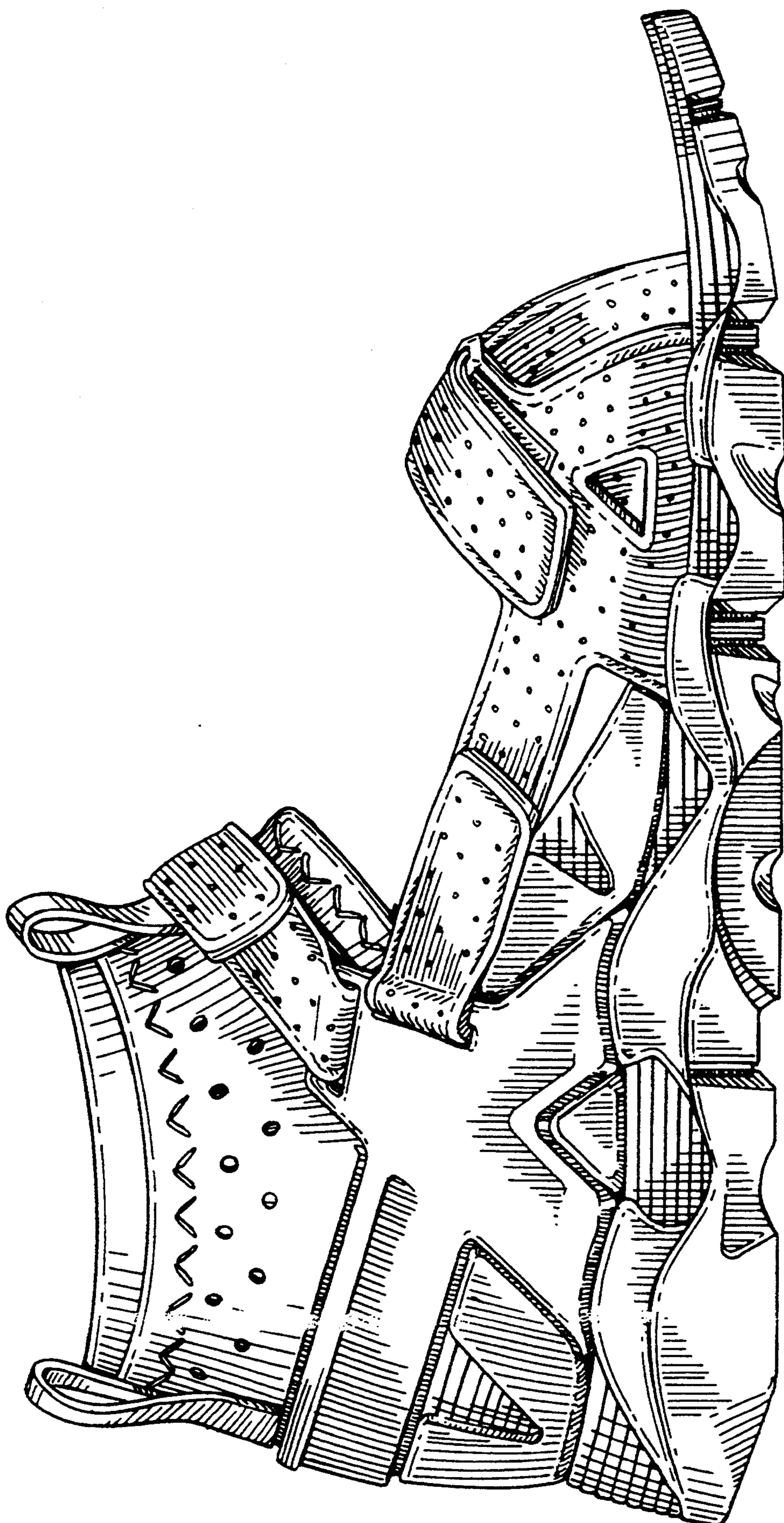

FIG. 9

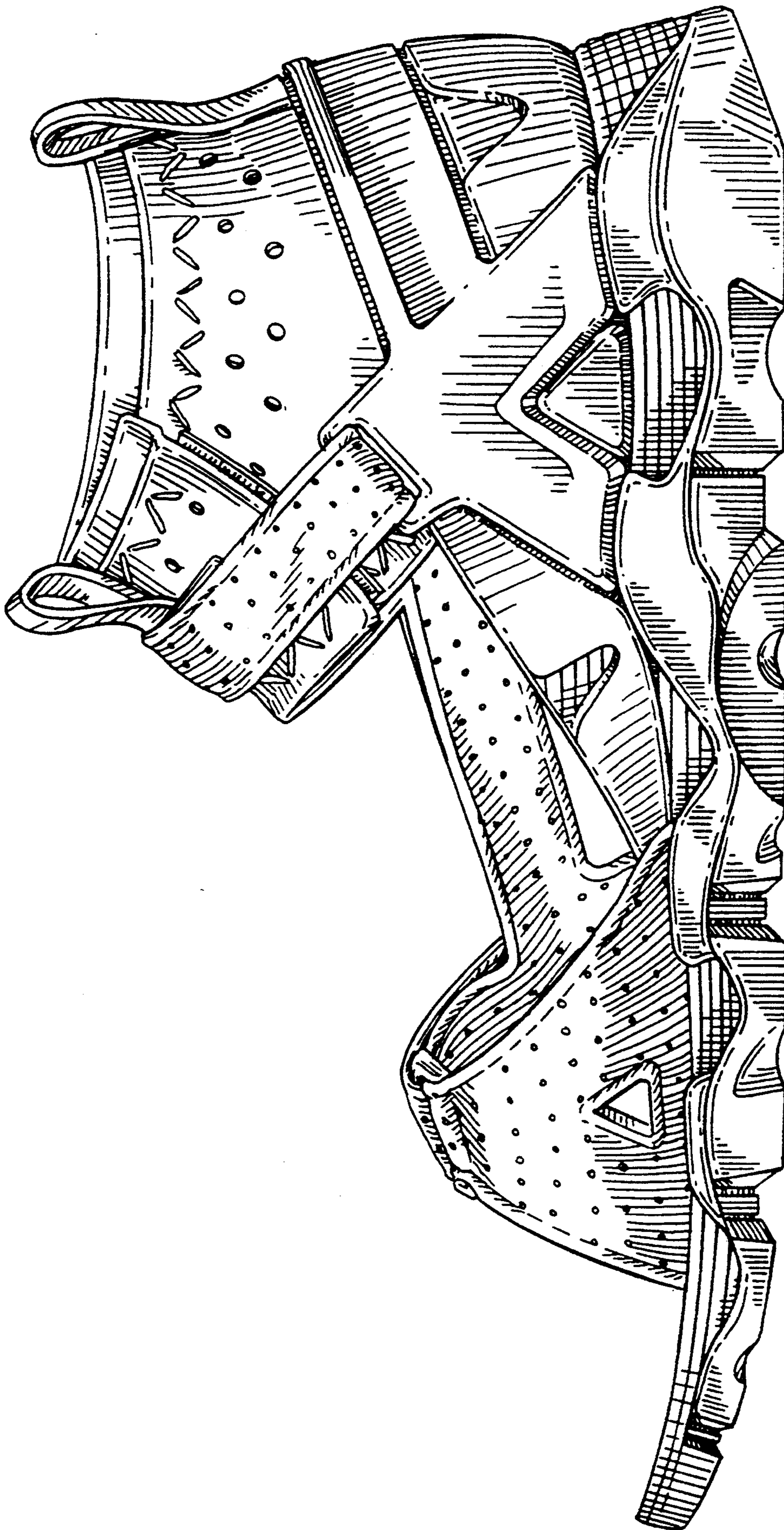

FIG. 10

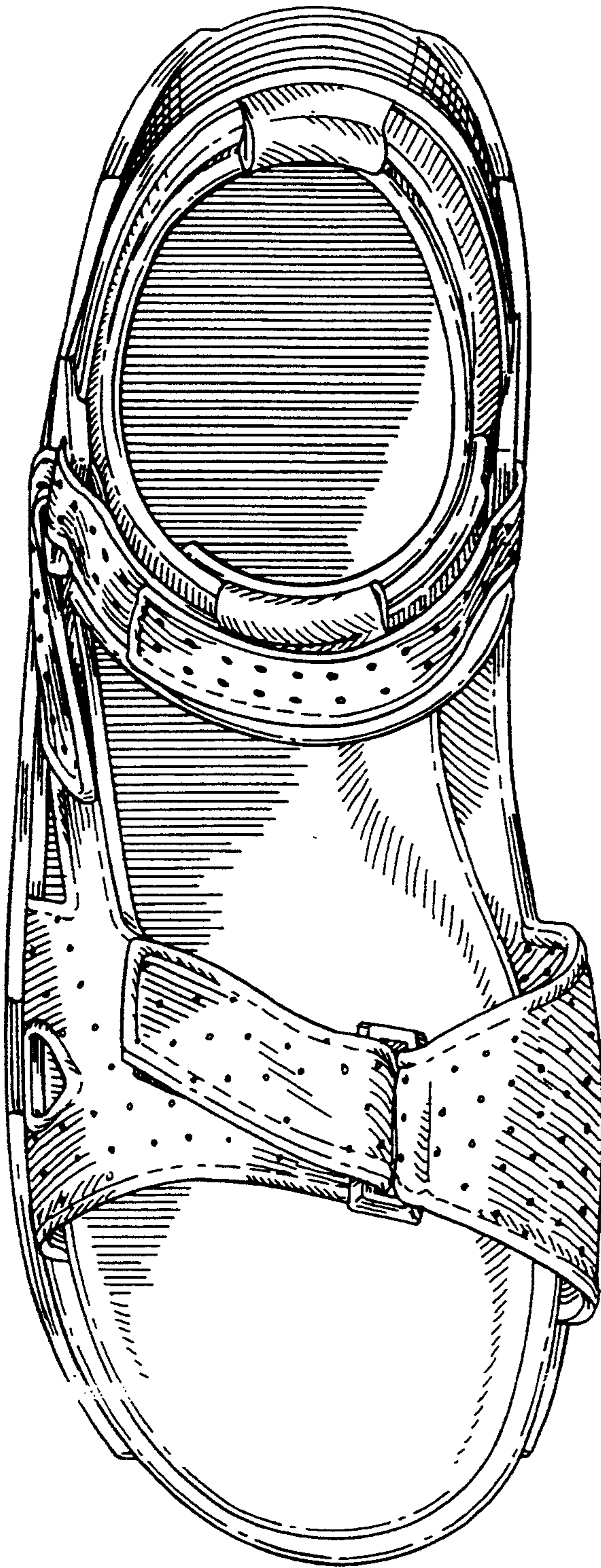

FIG. 11

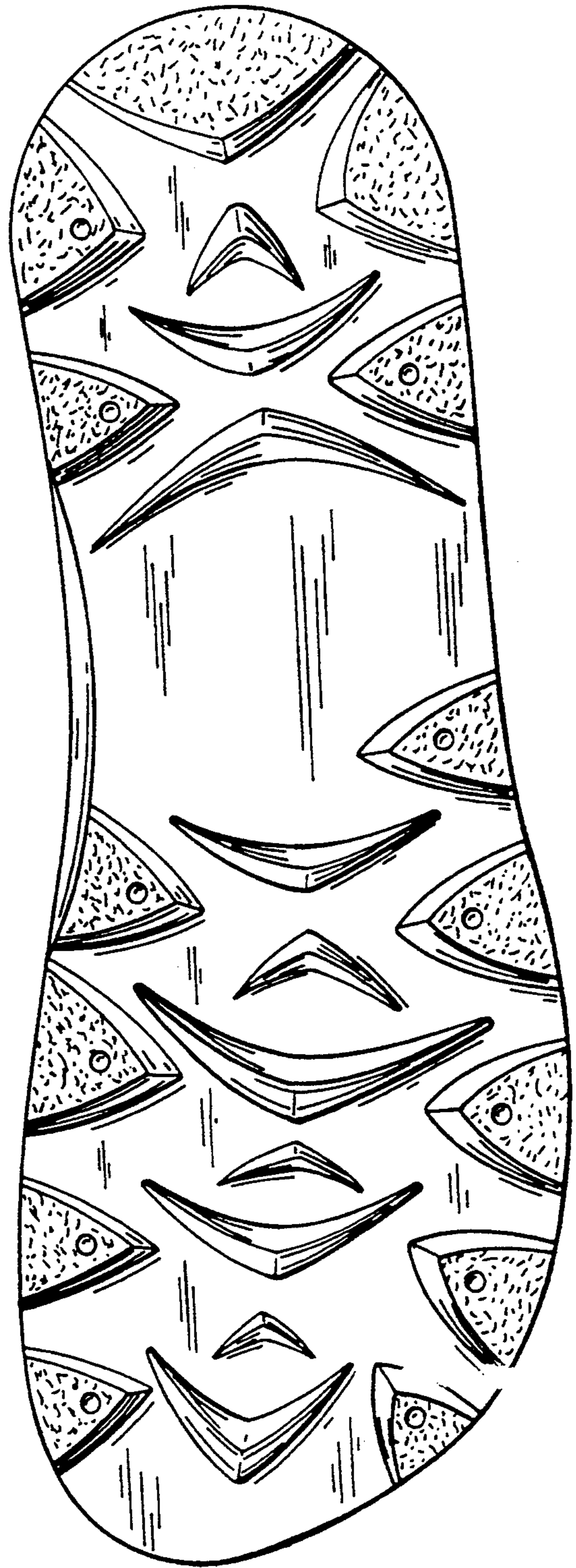

FIG. 12

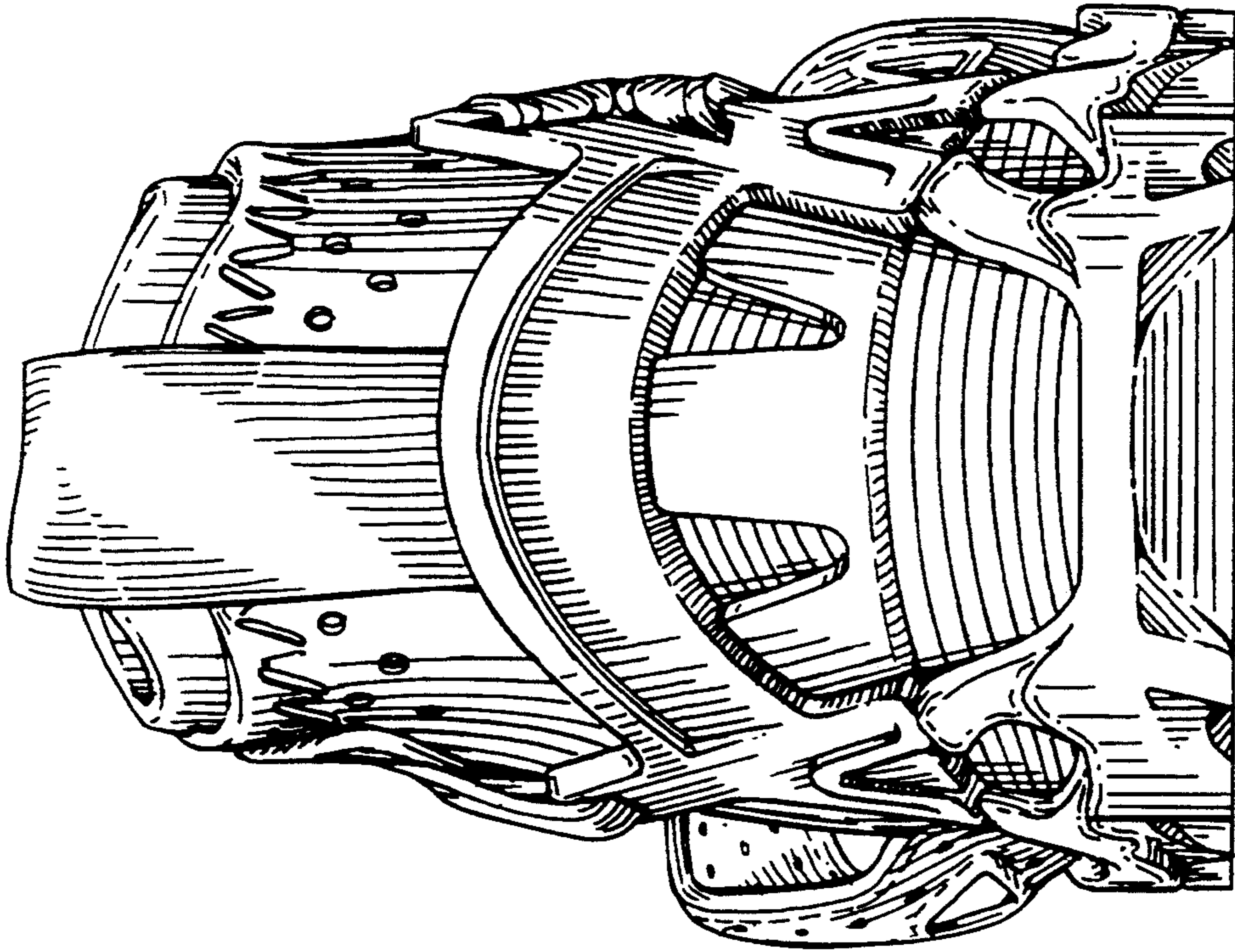

FIG. 14

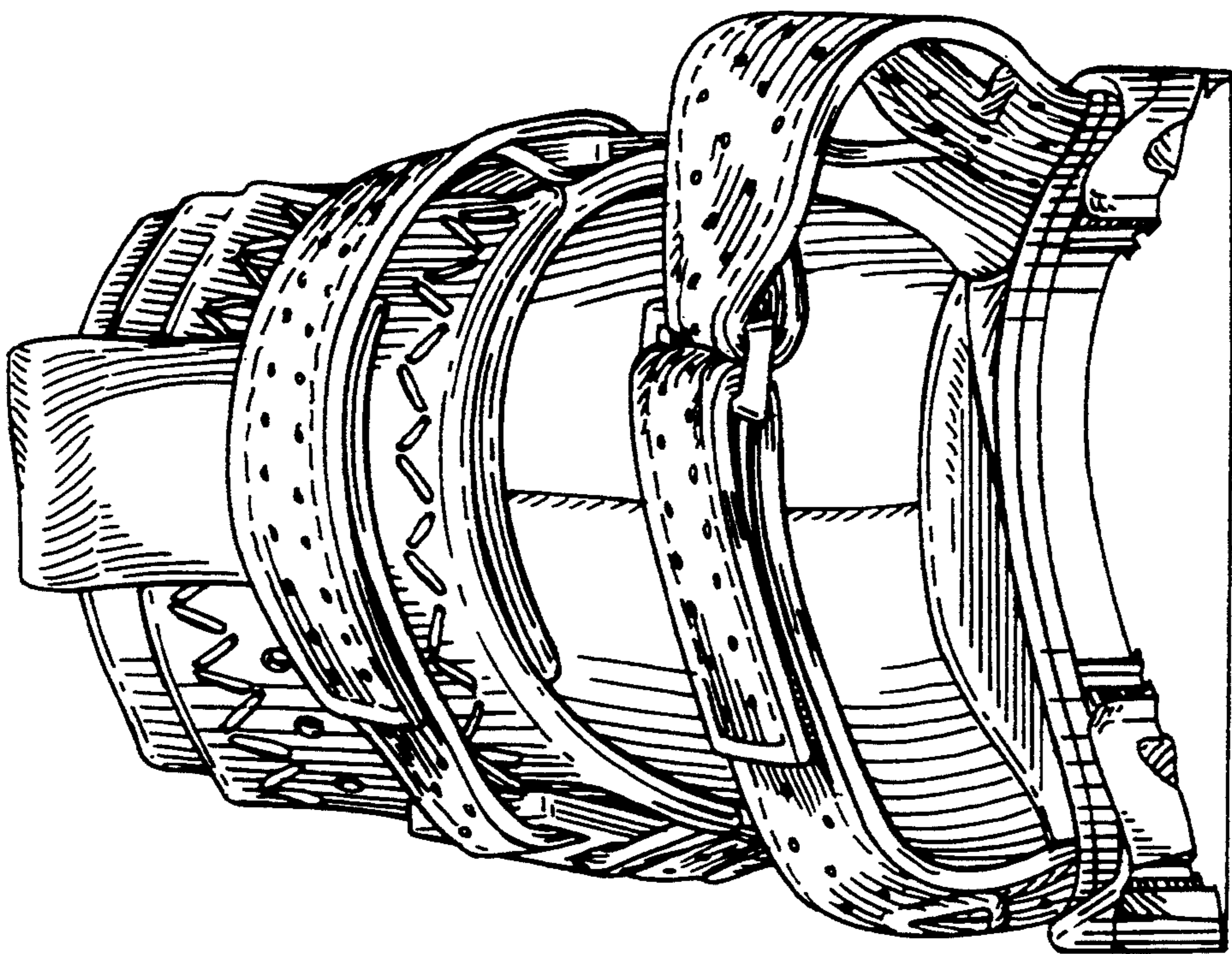

FIG. 13