



US00D351702S

# United States Patent [19]

[11] Patent Number: Des. 351,702

Breen

[45] Date of Patent: \*\* Oct. 18, 1994

## [54] INTEGRAL HANDLE FOR TRASH CONTAINER

[75] Inventor: John D. Breen, Wooster, Ohio

[73] Assignee: Rubbermaid Incorporated, Wooster, Ohio

[\*\*] Term: 14 Years

[21] Appl. No.: 17,474

[22] Filed: Jan. 14, 1994

[52] U.S. Cl. .... D34/10; D8/320

[58] Field of Search ..... 220/318, 337, 300, 404, 220/908-911, 200, 253, 254; D8/300, 307, 310, 311, 319, 320; 16/110 R, 110.5, 111, 119, 125, DIG. 19, DIG. 12; D34/1, 7, 10, 11

## [56] References Cited

### U.S. PATENT DOCUMENTS

|            |         |                  |       |           |
|------------|---------|------------------|-------|-----------|
| D. 169,508 | 5/1953  | Kuhn             | ..... | D8/320    |
| D. 175,865 | 10/1955 | Stone            | ..... | D8/319    |
| D. 247,087 | 1/1978  | Dickinson        | ..... | D7/194    |
| D. 260,229 | 8/1981  | Maza et al.      | ..... | D7/189    |
| D. 292,638 | 11/1987 | Carville         | ..... | D34/5     |
| D. 312,161 | 11/1990 | Toscano          | ..... | D34/11    |
| D. 323,914 | 2/1992  | Doxey et al.     | ..... | D34/5     |
| D. 324,595 | 3/1992  | Beese et al.     | ..... | D34/5     |
| D. 326,342 | 5/1992  | Doxey et al.     | ..... | D34/7     |
| D. 329,930 | 9/1992  | Delmerico et al. | ..... | D34/7     |
| 4,351,539  | 9/1982  | Rodolakis        | ..... | 280/47.26 |
| 4,691,840  | 9/1987  | Ferbrache        | ..... | 220/318   |
| 4,836,394  | 6/1989  | Giomski          | ..... | 220/1     |

### OTHER PUBLICATIONS

Catalog page, Trash container; Sterilite Corporation, P.O. Box 524, Townsend, Mass. 01469. Publication date 1992.

Sell sheet, Trash container; Toter Incorporated, P.O. Box 5338, 841 Meacham Road, Statesville, N.C. 28677. Publication date Apr. 1992.

Sell sheet, Trash container; Zarn, Inc., Reidsville, N.C. 27320. Publication date Jun. 1992.

Price list; Trash containers; Contico Manufacturing Company, 1101 Warson Road, St. Louis, Mo. 63132. Publication date Aug. 1, 1986.

Page 10, Trash containers; Tucker Housewares, 25

Tucker Drive, Leominster, Mass. 01469. It is believed that the product depicted herein has been on sale for more than one (1) year prior to the application date of this instant application.

Catalog page, Trash containers; Tucker Housewares, 25 Tucker Drive, Leominster, Mass. 01469. Publication date 1992.

Sell sheet, Trash container; Bonar Plastics Ltd., address unknown. It is believed that the product depicted herein has been on sale for more than one (1) year prior to the application date of this instant application.

Sell sheet, Trash container; Plastic Omnium, Den Engelsman 1, Postbus 2624, 6026 ZB Maarheeze. It is believed that the product depicted herein has been on sale for more than one (1) year prior to the application date of this instant application.

Page 6, Refuse bin; Curver, Takkebijsters 75, Postbus 6810, 4802 HV Breda. Publication date 1991.

Page 16, Refuse containers; Rubbermaid Commercial Products Inc., 3124 Valley Avenue, Winchester, VA 22601. Publication date 1992.

Page 28, Refuse containers; Rubbermaid Incorporated, 1147 Akron Road, Wooster, Ohio 44691. Publication date 1990.

*Primary Examiner*—Wallace R. Burke

*Assistant Examiner*—Robin V. Taylor

*Attorney, Agent, or Firm*—Richard B. O'Planick; Lisa B. Riedesel

## [57] CLAIM

The ornamental design for a integral handle for trash container, as shown and described.

## DESCRIPTION

FIG. 1 is a top left front perspective view of a integral handle for trash container showing my new design. The broken lines are for illustrative purposes only and form no part of the claimed design;

FIG. 2 is a top plan view thereof;

FIG. 3 is a bottom plan view thereof;

FIG. 4 is a left side elevational view thereof; the right side elevational view being a mirror image;

FIG. 5 is a front elevational view thereof; and,

FIG. 6 is a rear elevational view thereof.

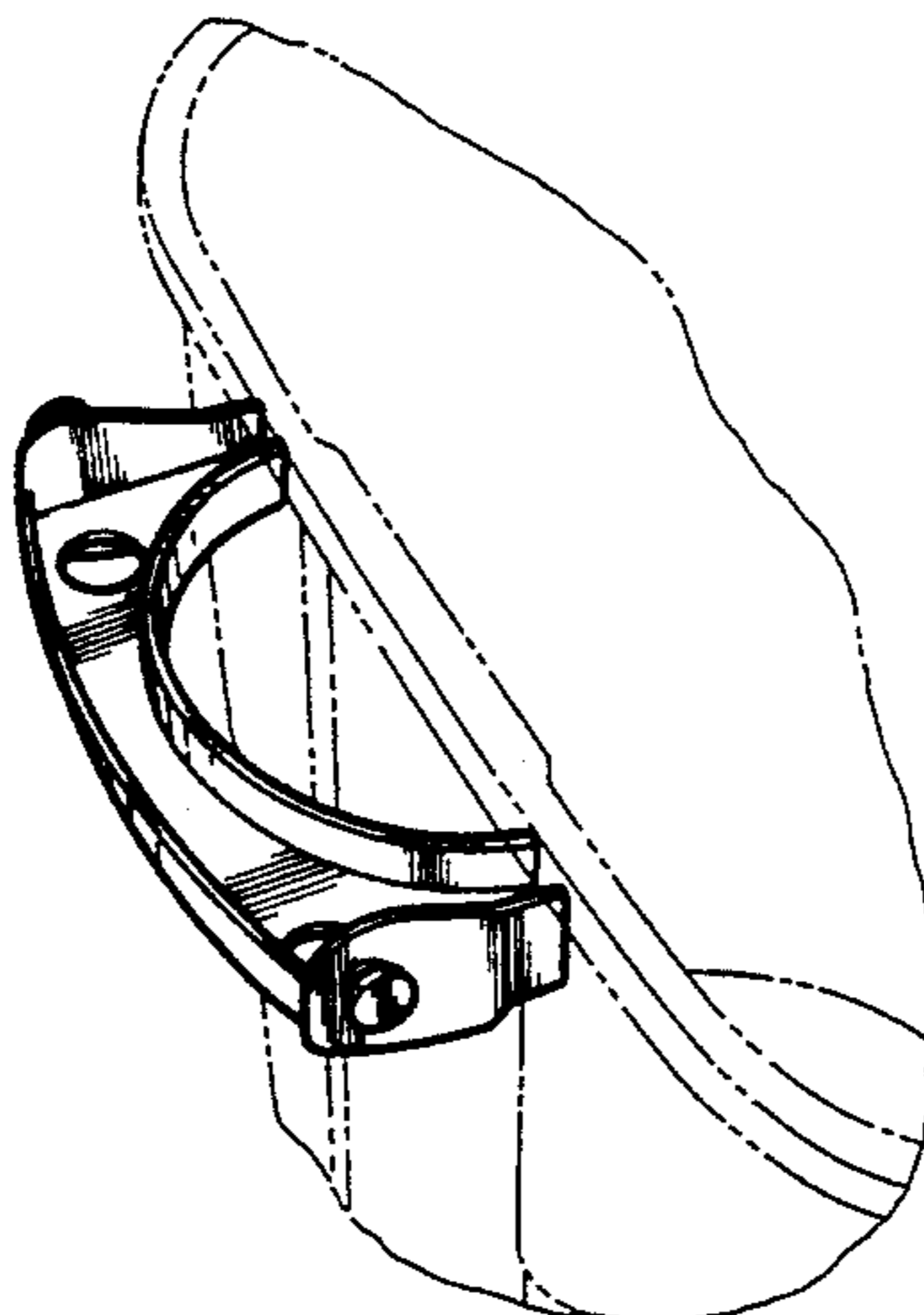

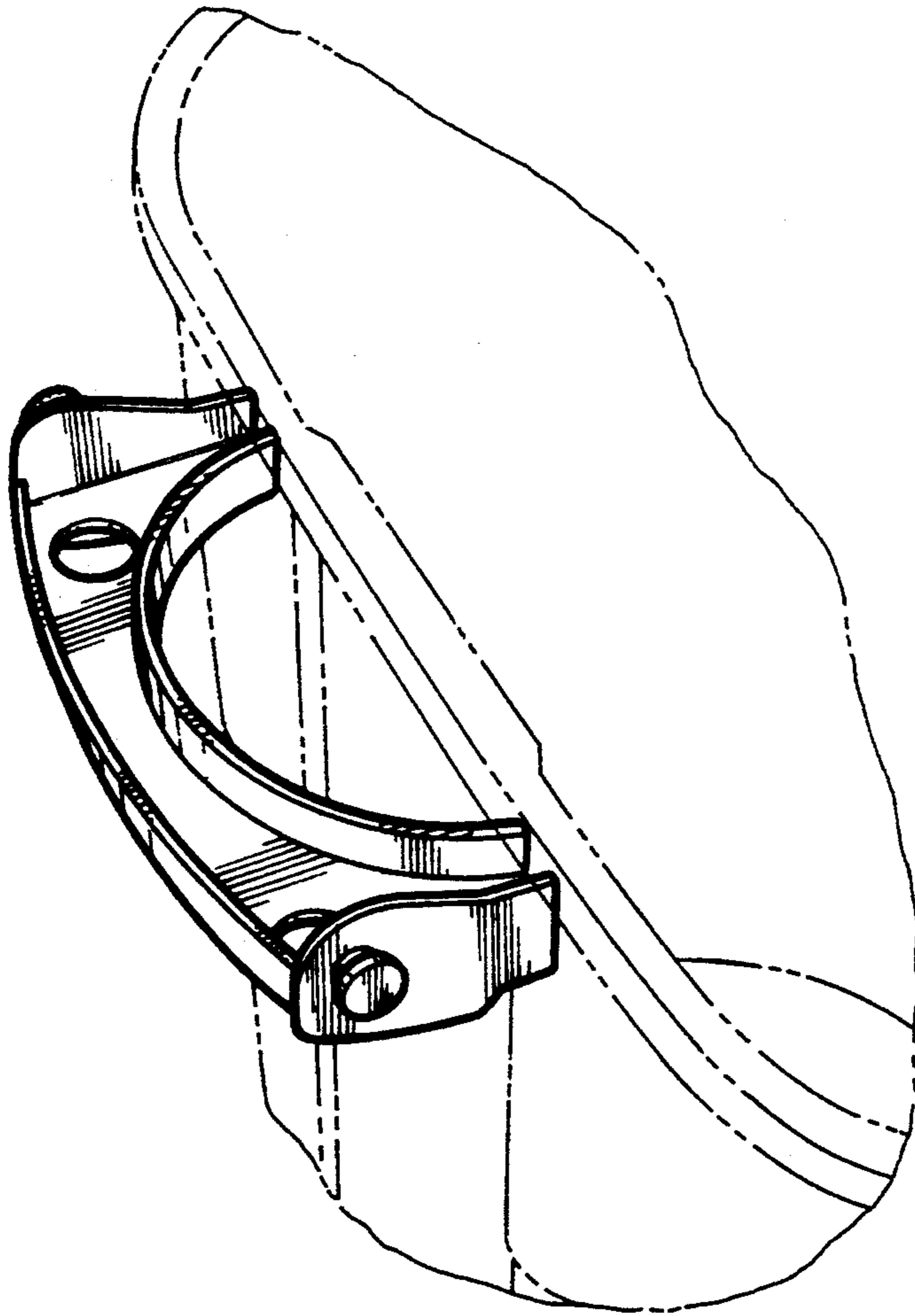

Fig-1

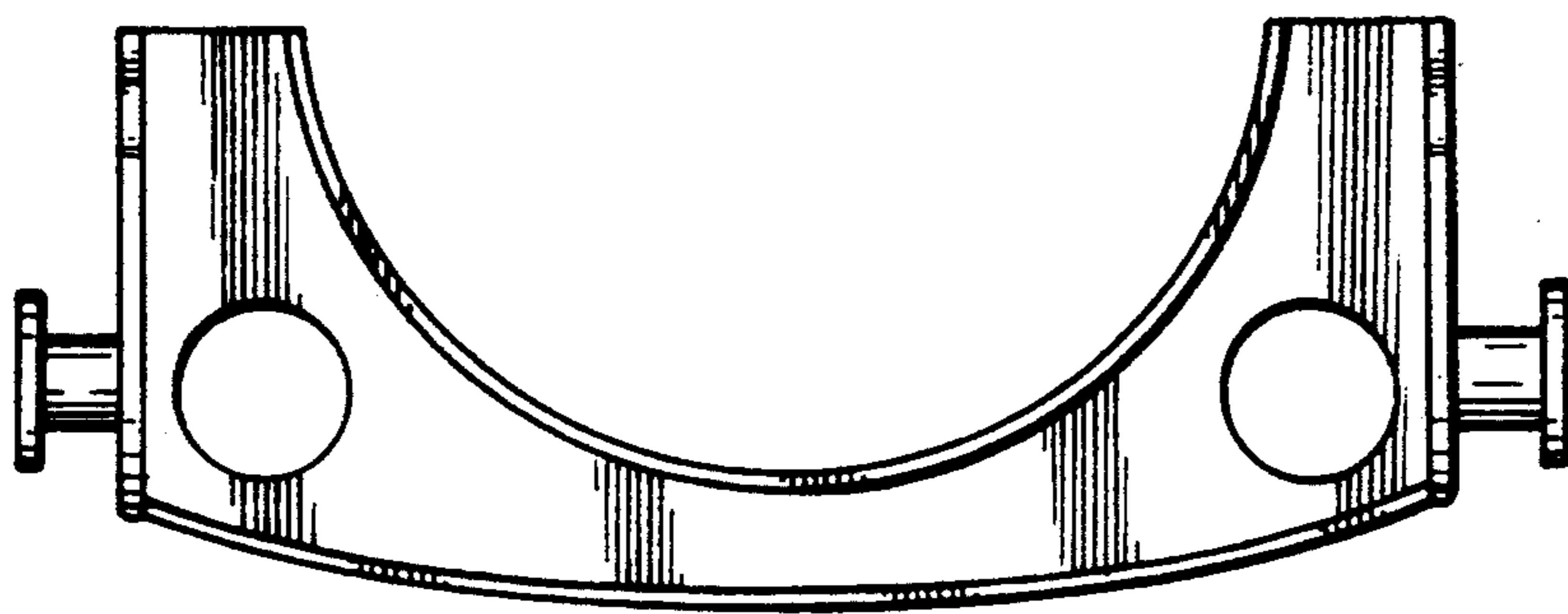

Fig-2

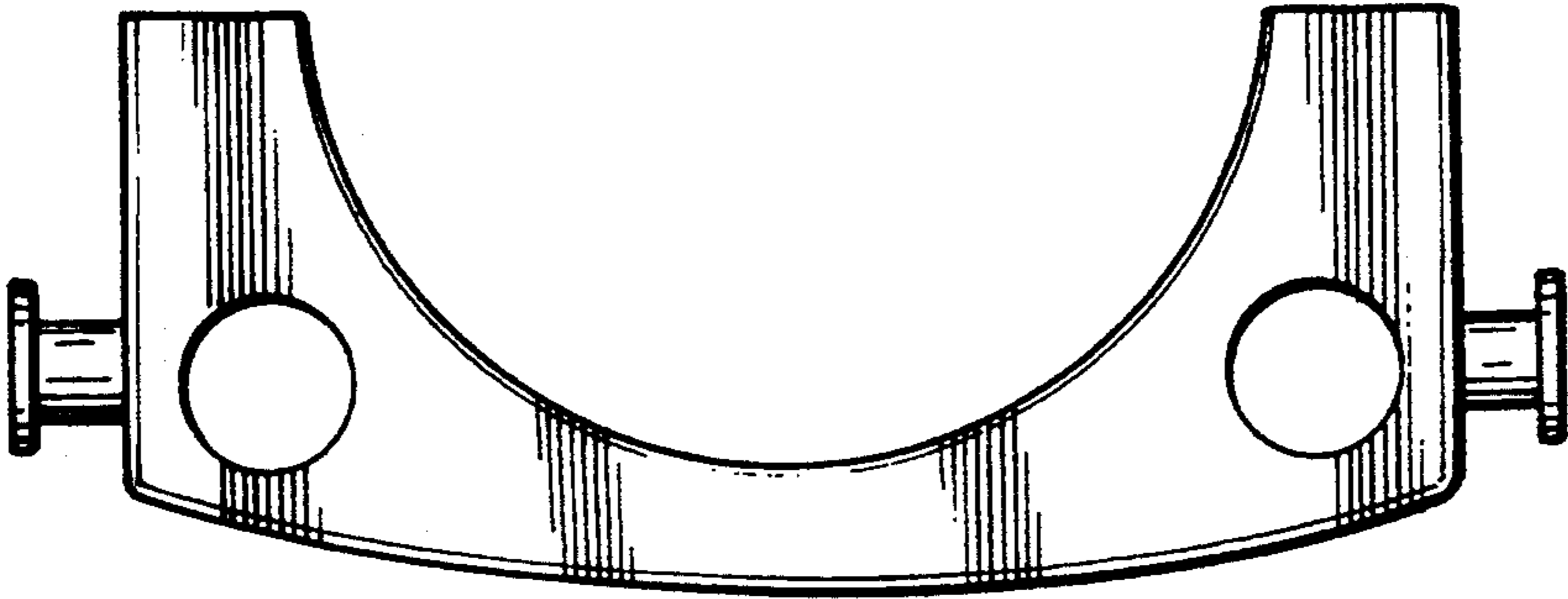

Fig-3

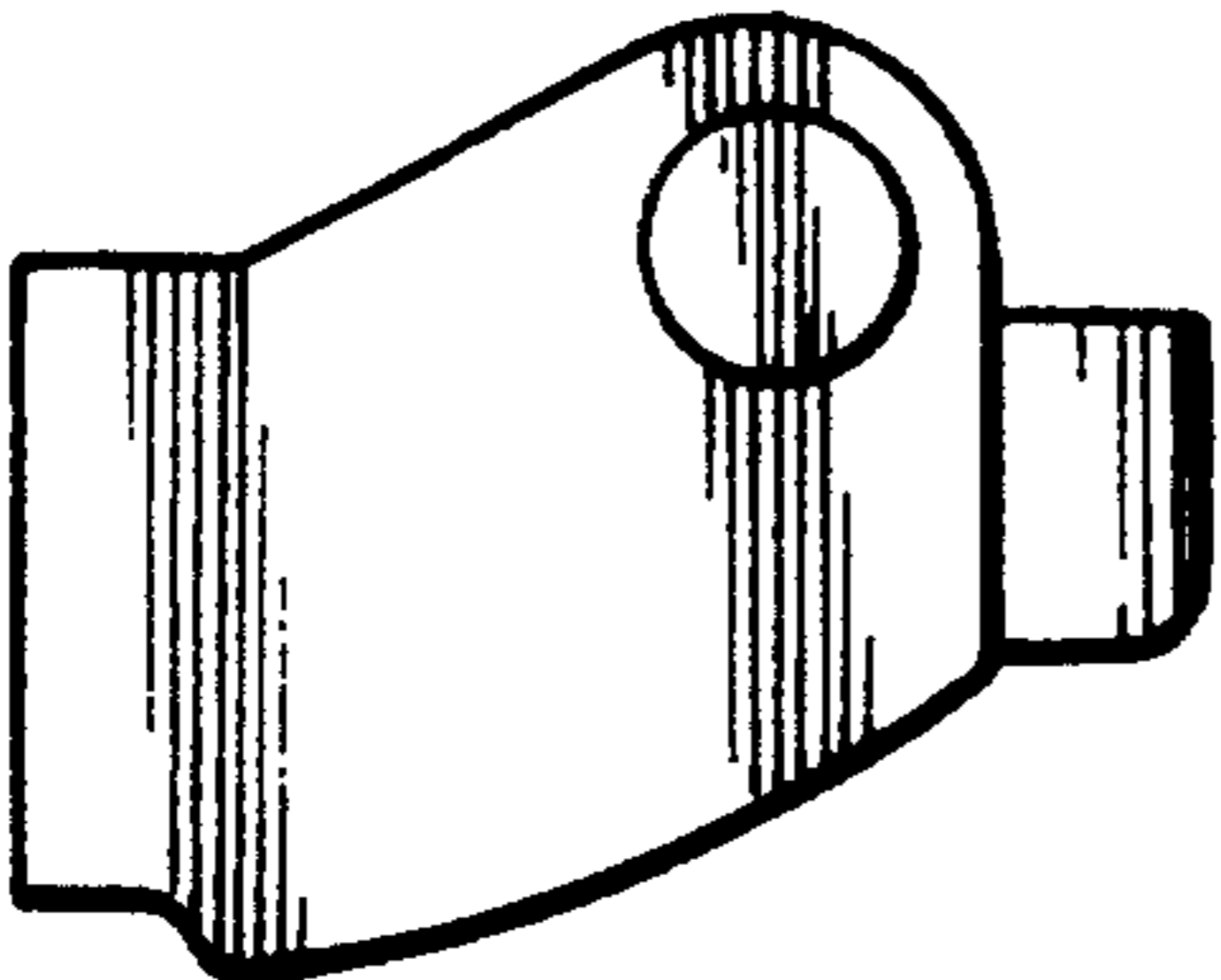

Fig-4

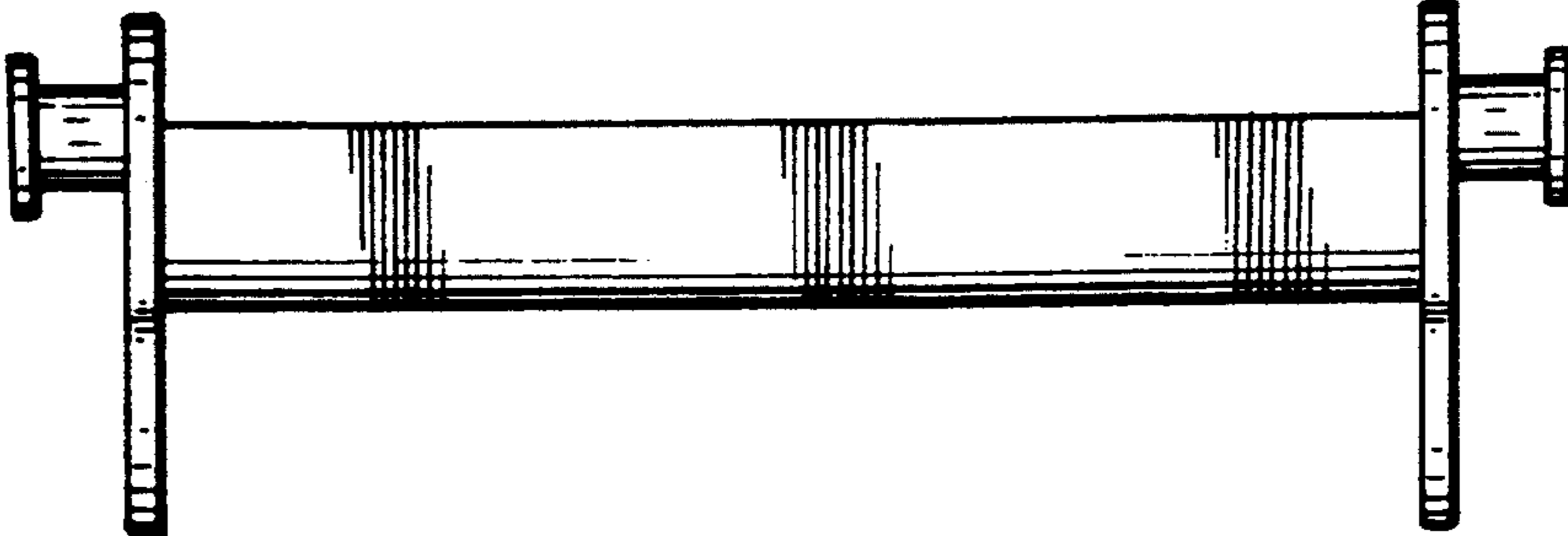

Fig-5

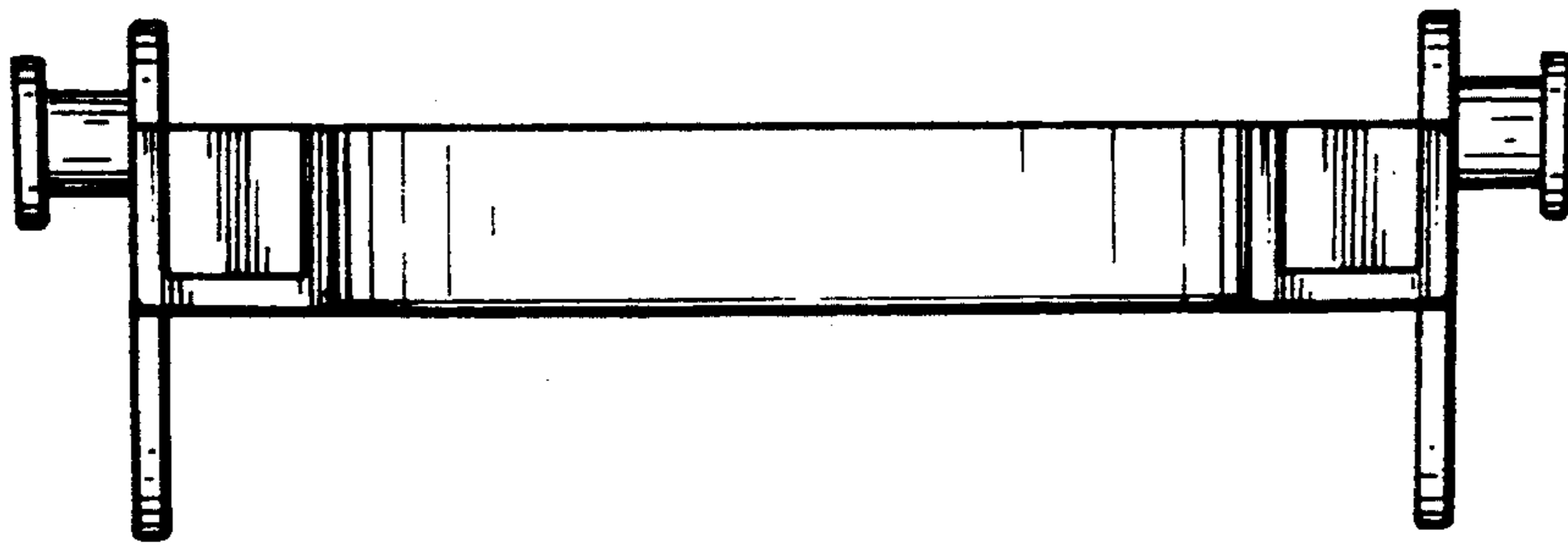

Fig-6