



US00D351679S

**United States Patent** [19]  
**Chen**

[11] **Patent Number: Des. 351,679**

[45] **Date of Patent: \*\* Oct. 18, 1994**

[54] **ARCH-SHAPED TABLE LAMP**

[76] **Inventor: Chien-Chung Chen, c/o Hung Hsing Patent Service Center, P.O. Box 55-1670, Taipei (10477), Taiwan**

[\*\*] **Term: 14 Years**

[21] **Appl. No.: 10,167**

[22] **Filed: Jul. 1, 1993**

[52] **U.S. Cl. .... D26/107**

[58] **Field of Search ..... 362/410-414; D26/93, 102-112**

[56] **References Cited**

**U.S. PATENT DOCUMENTS**

D. 308,424 6/1990 Nishida ..... D26/107

D. 327,137 6/1992 Wu ..... D26/107  
2,511,780 6/1950 Masterson ..... 362/410 X

*Primary Examiner*—Susan J. Lucas

[57] **CLAIM**

The ornamental design for arch-shaped table lamp, as shown and described.

**DESCRIPTION**

FIG. 1 is a left side elevational view of a arch-shaped table lamp showing my new design; FIG. 2 is a right side elevational view; FIG. 3 is a front elevational view; FIG. 4 is a rear elevational view; FIG. 5 is a top plan view; FIG. 6 is a bottom plan view; and, FIG. 7 is a perspective view.

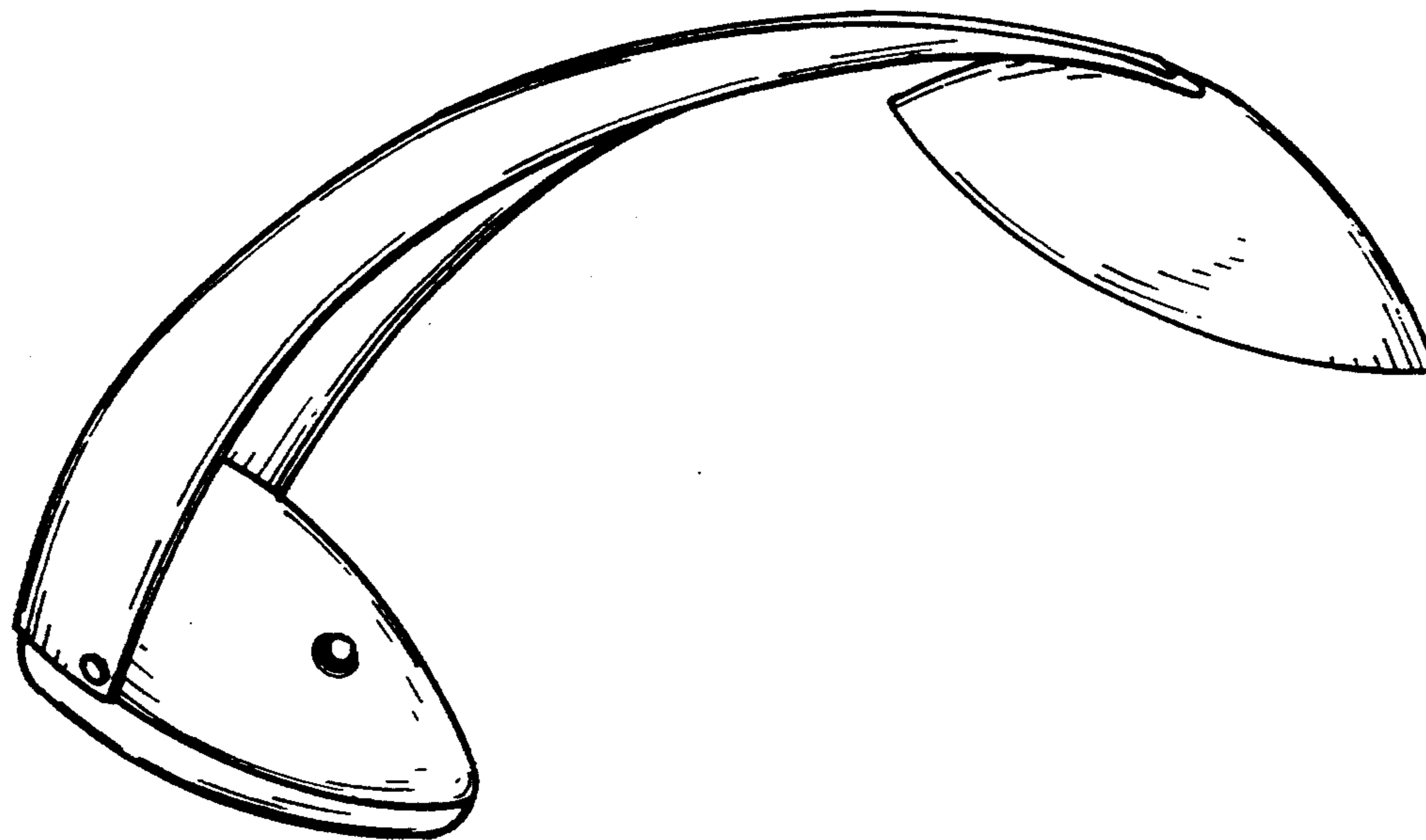

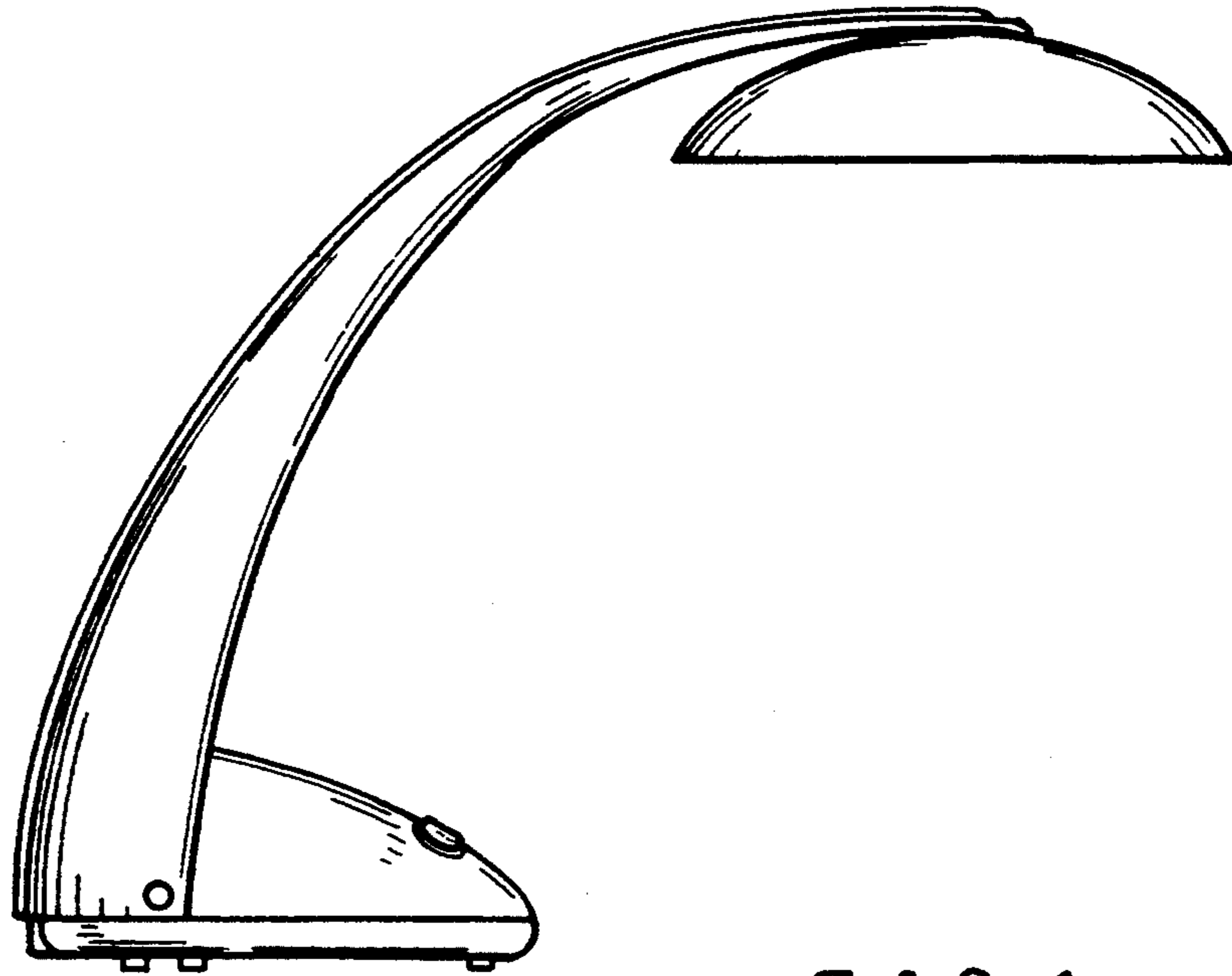

FIG. 1

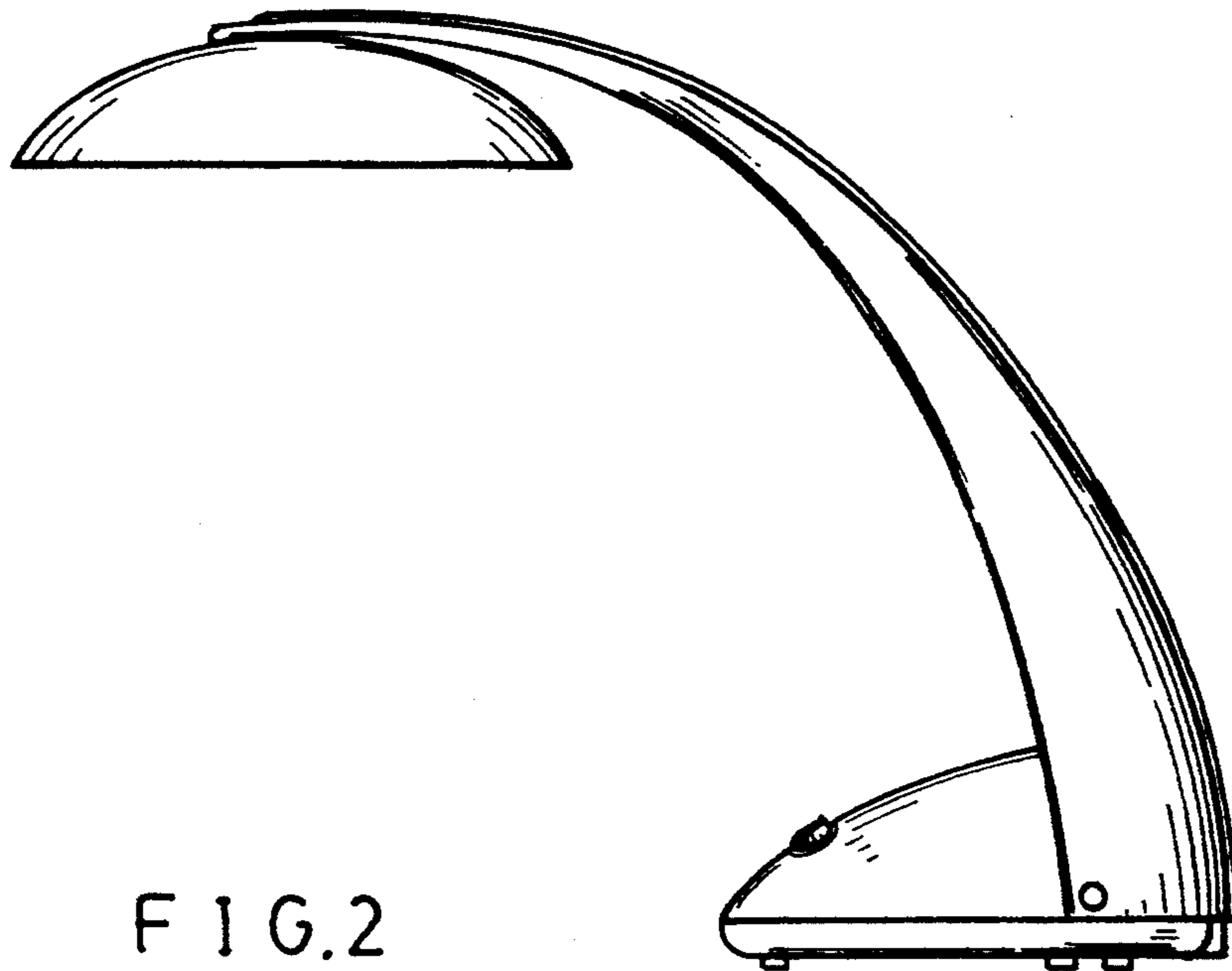

FIG. 2

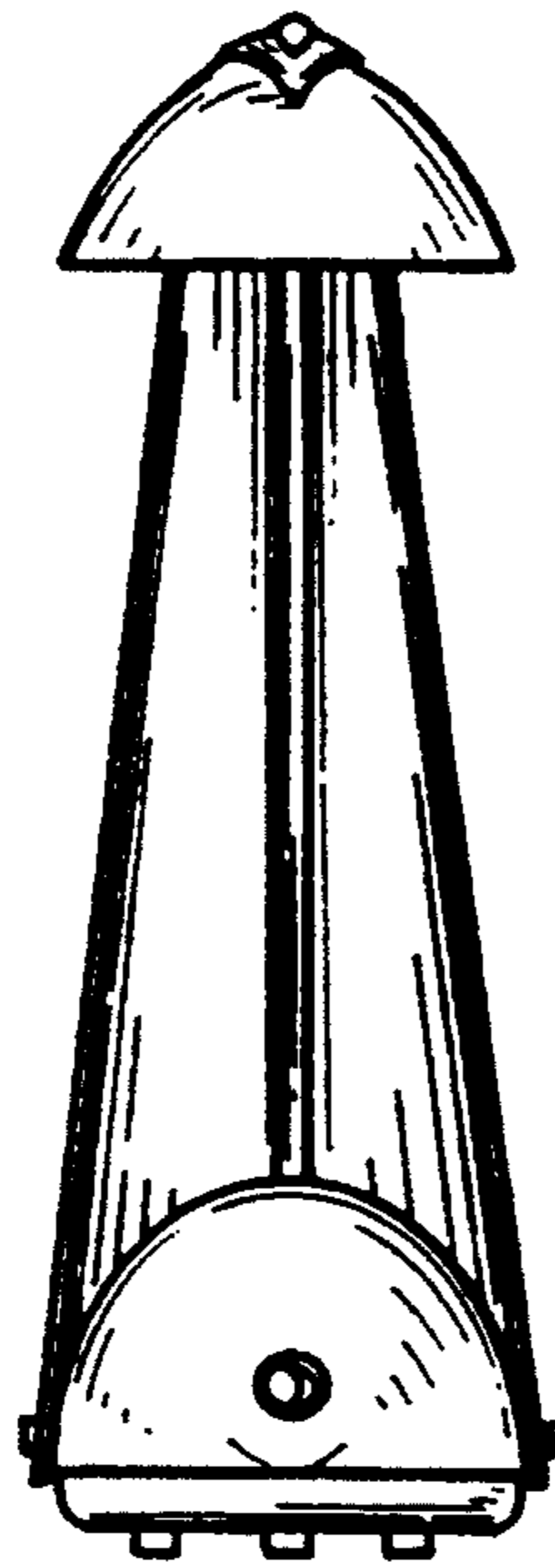

FIG. 3

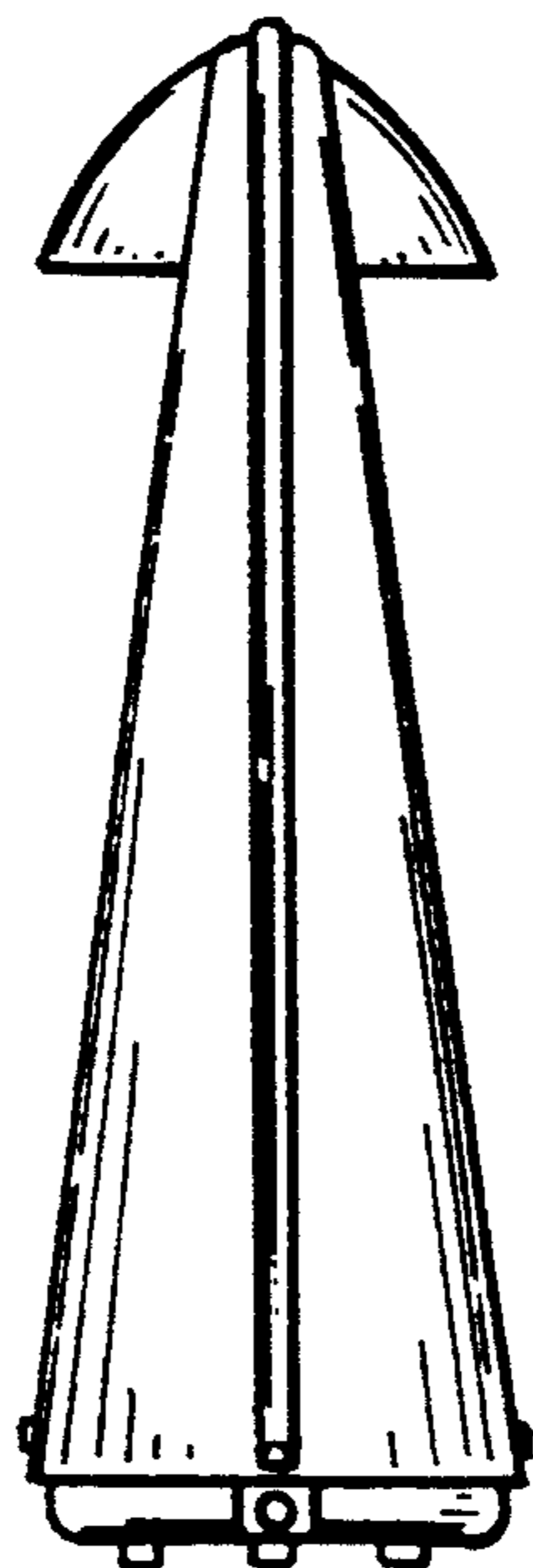

FIG. 4

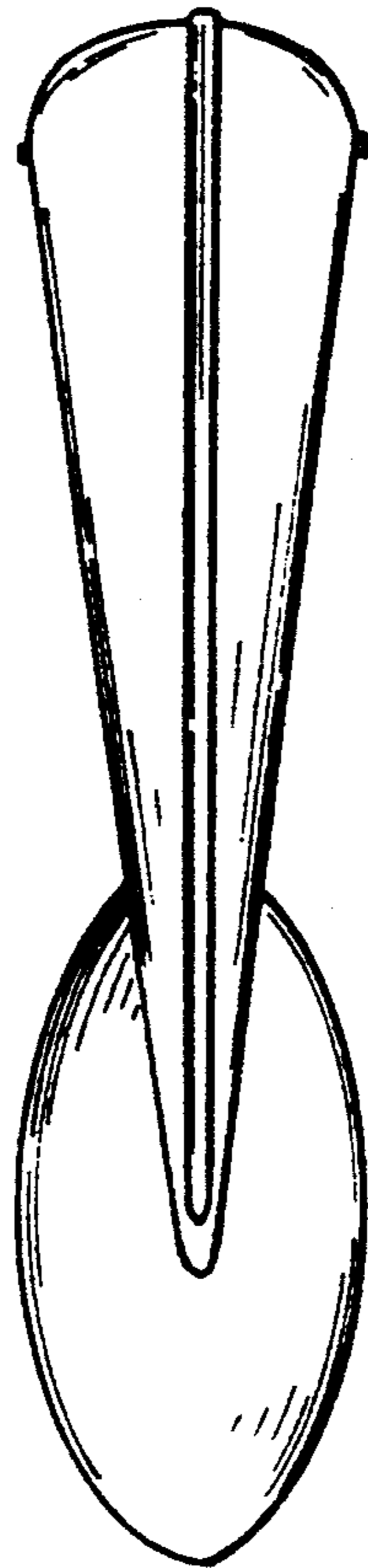

FIG. 5

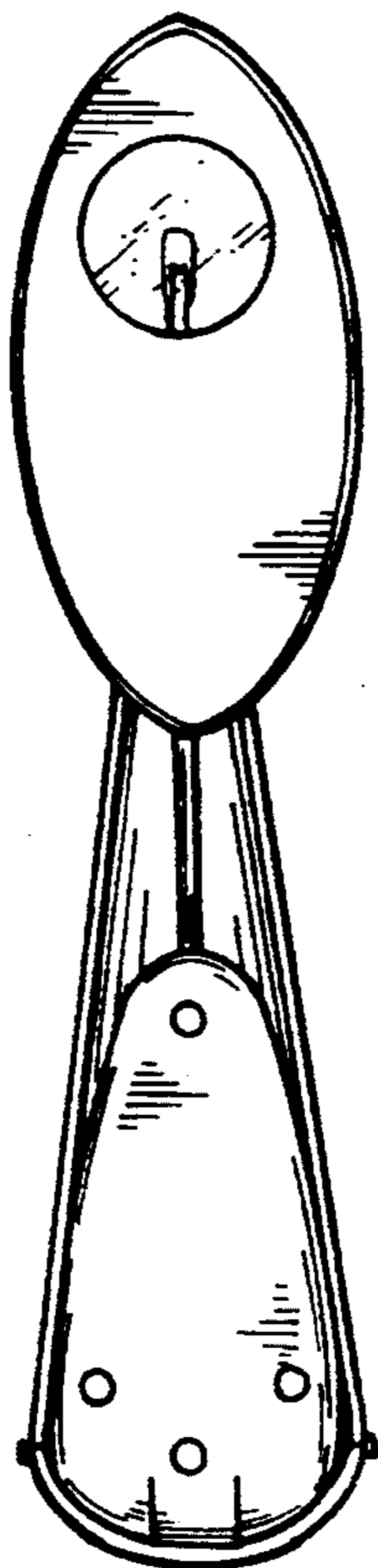

FIG. 6

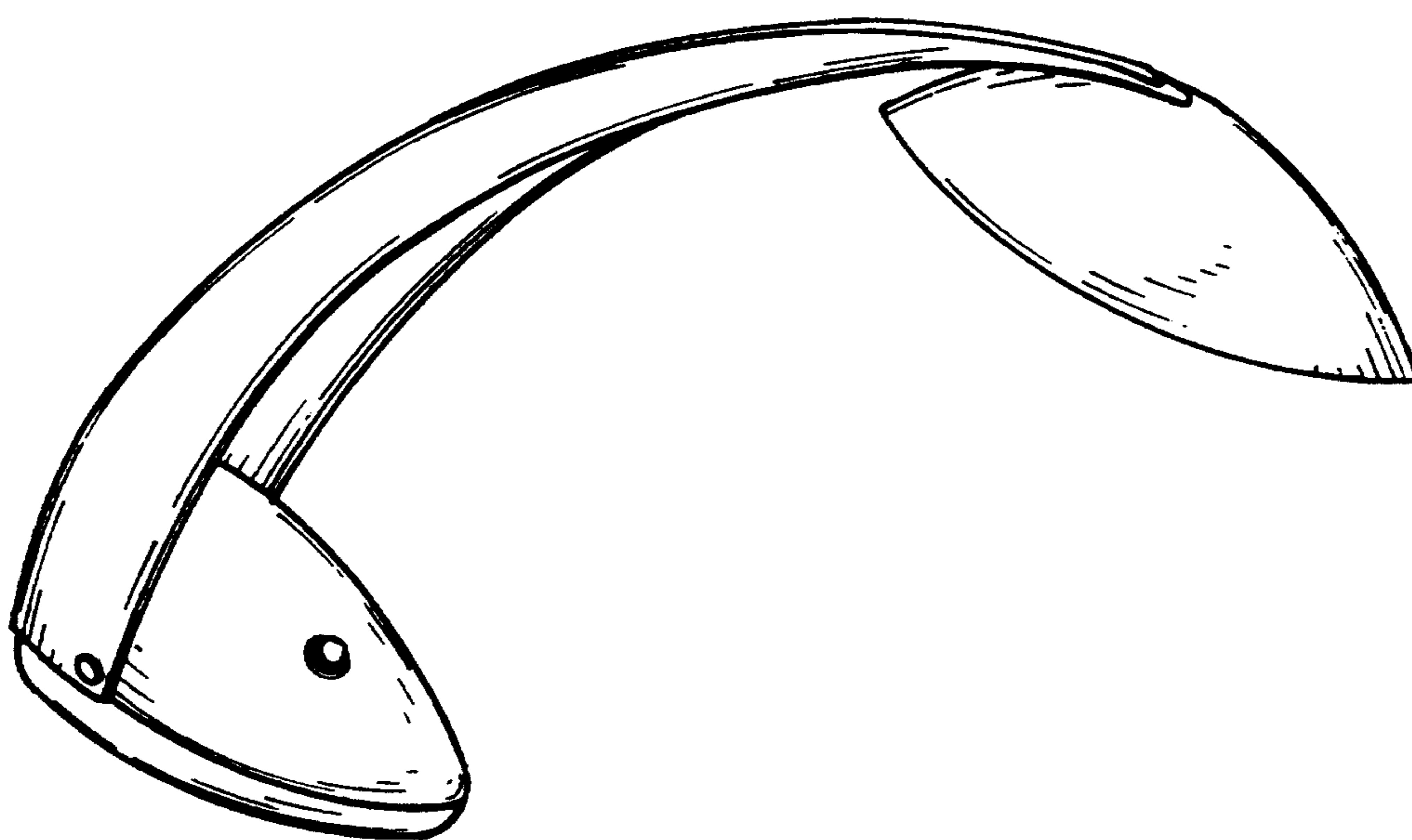

FIG. 7