



US00D351483S

**United States Patent** [19]  
**Angeletta**

[11] **Patent Number: Des. 351,483**

[45] **Date of Patent: \*\* Oct. 11, 1994**

[54] **LIQUID AND LOTION APPLICATOR**

[76] **Inventor: Joseph G. Angeletta, 418 Fifth St., Mamaroneck, N.Y. 10543**

[\*\*] **Term: 14 Years**

[21] **Appl. No.: 792,733**

[22] **Filed: Nov. 15, 1991**

D. 323,409 1/1992 Giese ..... D28/7

*Primary Examiner*—Bernard Ansher  
*Assistant Examiner*—C. Tuttle  
*Attorney, Agent, or Firm*—Scully, Scott, Murphy & Presser

[57] **CLAIM**

The ornamental design for a liquid and lotion applicator, as shown and described.

**Related U.S. Application Data**

[63] Continuation-in-part of Ser. No. 607,483, Nov. 1, 1990, abandoned, which is a continuation of Ser. No. 223,801, Jul. 25, 1988, abandoned.

[52] **U.S. Cl.** ..... D28/7

[58] **Field of Search** ..... D4/114, 137, 126, 138; 132/320; 401/6, 138, 148, 183, 198, 206, 207, 270, 274; 15/244.1; D28/7, 63, 99; D32/43, 45

**DESCRIPTION**

FIG. 1 is a perspective view of a liquid and lotion applicator showing my new design;  
FIG. 2 is an enlarged bottom view of the applicator portion, shown fragmentarily for ease of illustration;  
FIG. 3 is an enlarged fragmentary view of the handle end;  
FIG. 4 is a top plan view shown partially broken away for ease of illustration;  
FIG. 5 is a front elevational view; and,  
FIG. 6 is a left side elevational view shown partially broken away for ease of illustration, the side opposite being a mirror image of the side shown.

[56] **References Cited**

**U.S. PATENT DOCUMENTS**

D. 265,255 6/1982 O'Neill ..... D28/7  
D. 308,264 5/1990 Redmann ..... D28/7

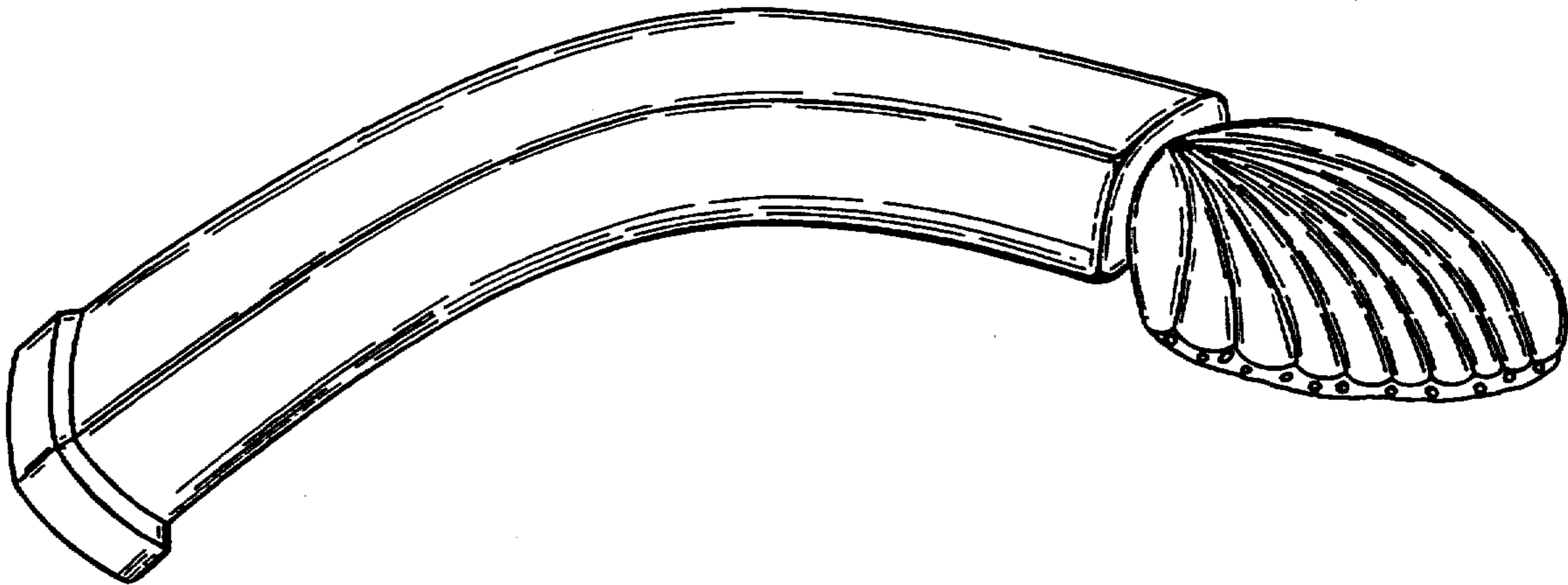

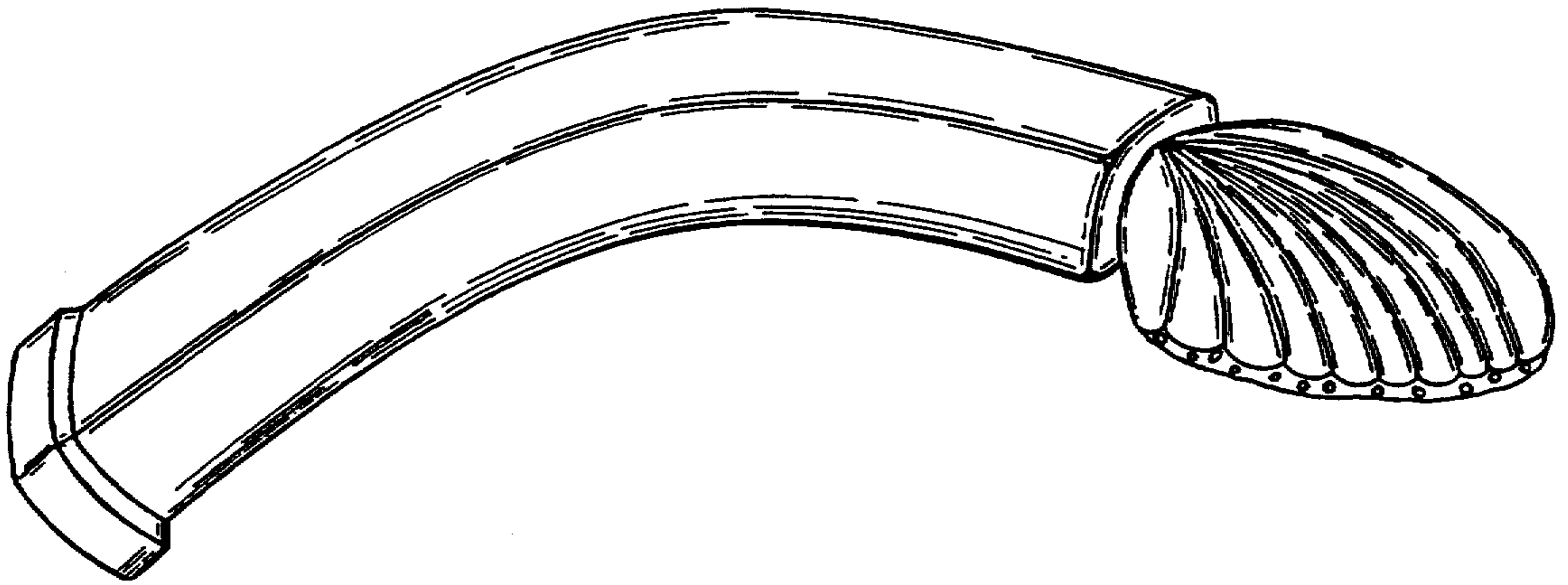

FIG. 1

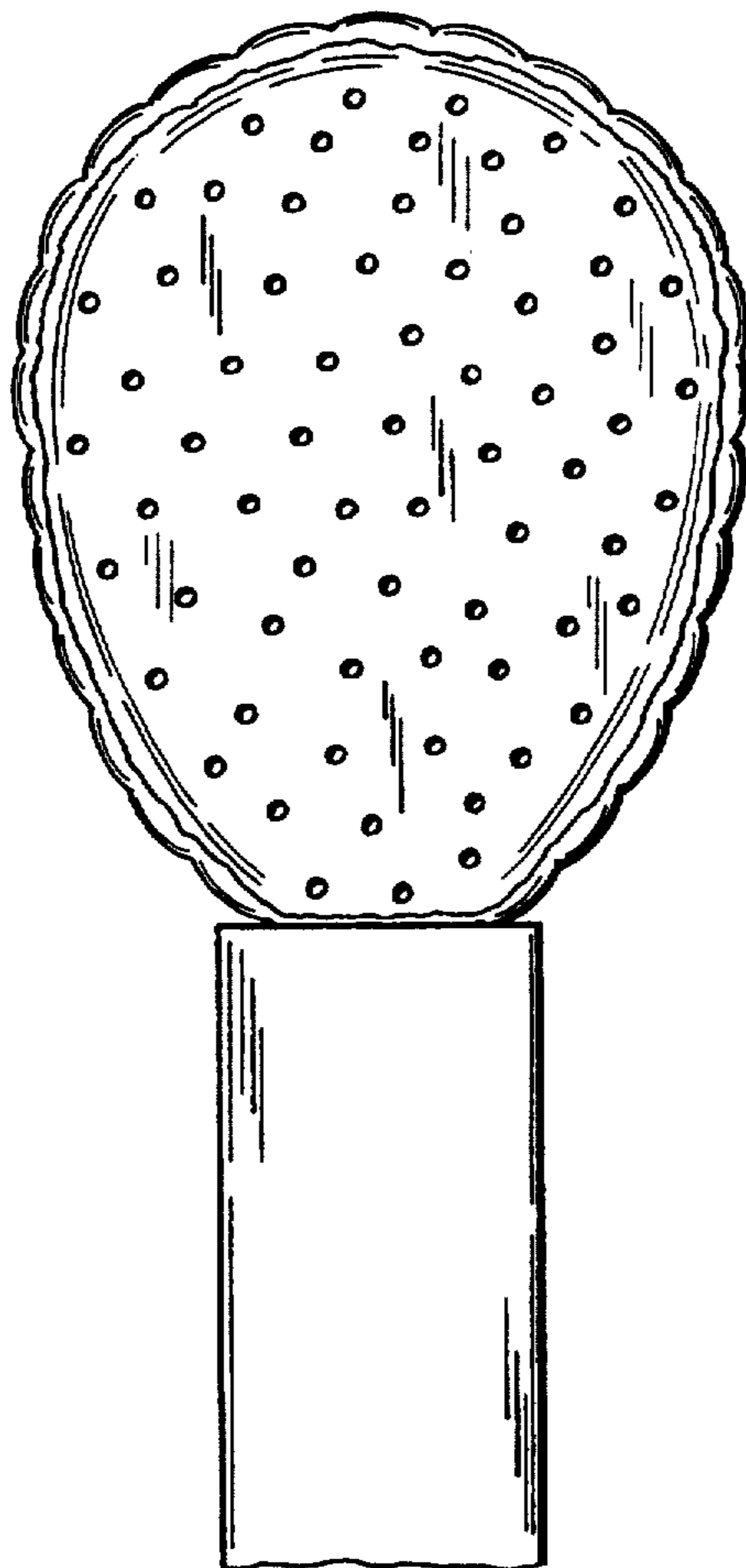

FIG. 2

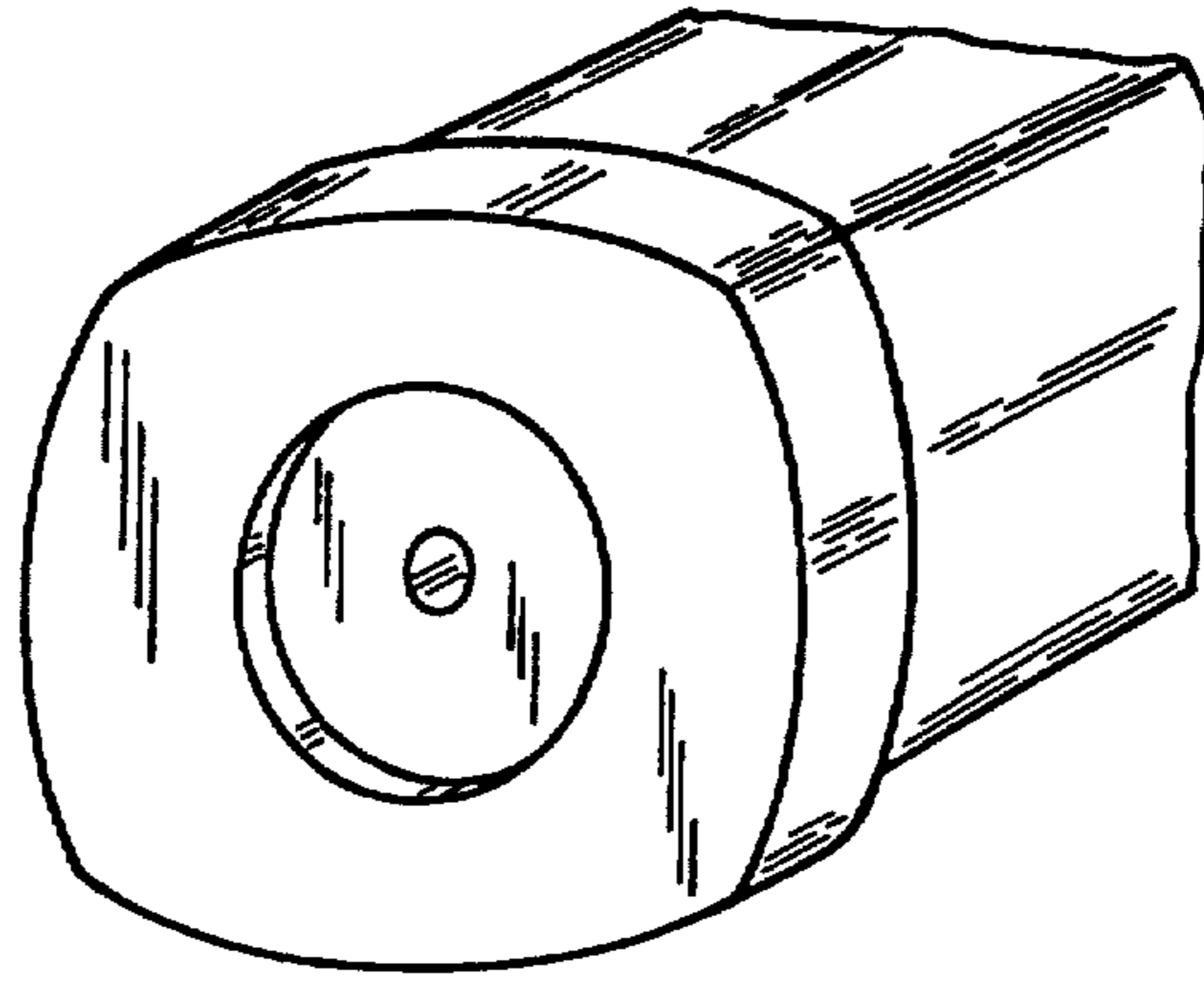

FIG. 3

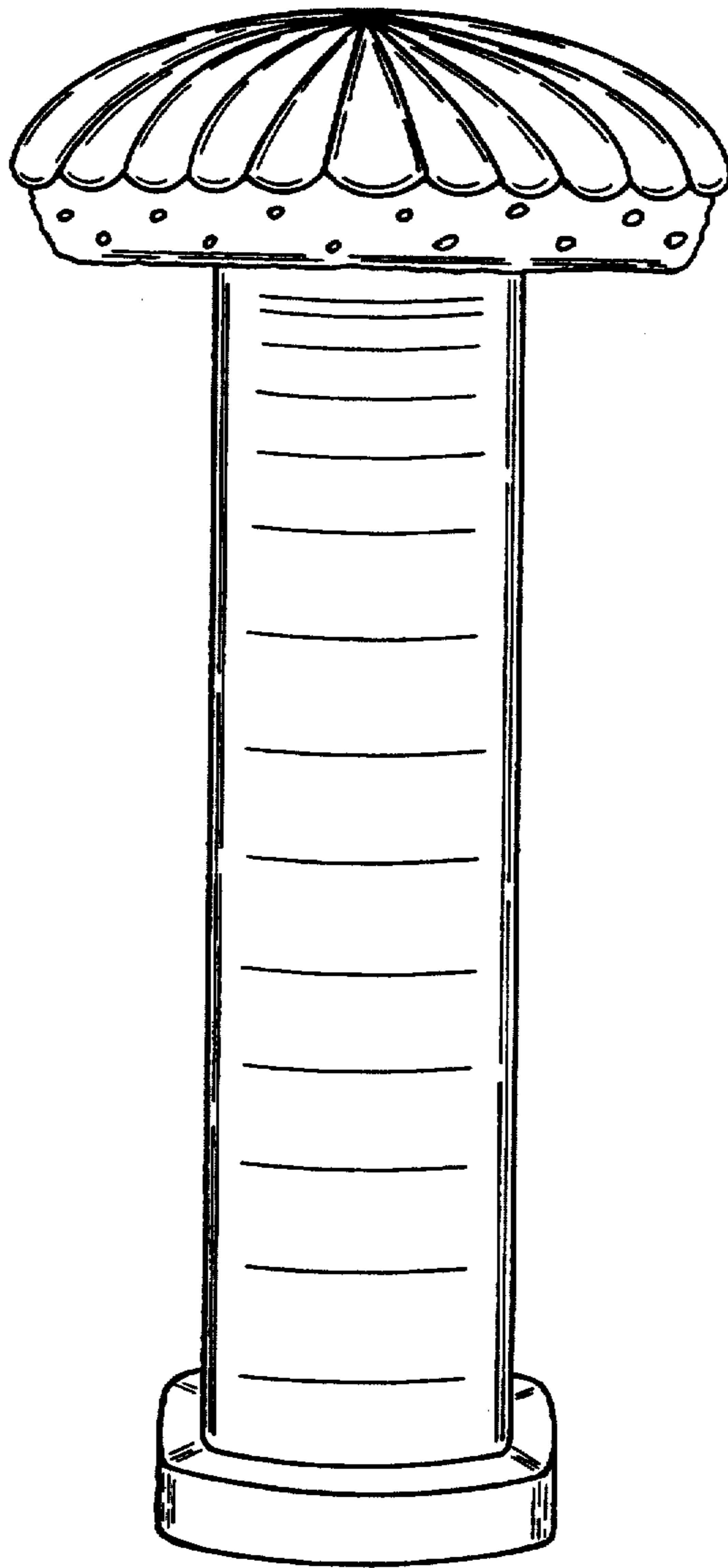

FIG. 5

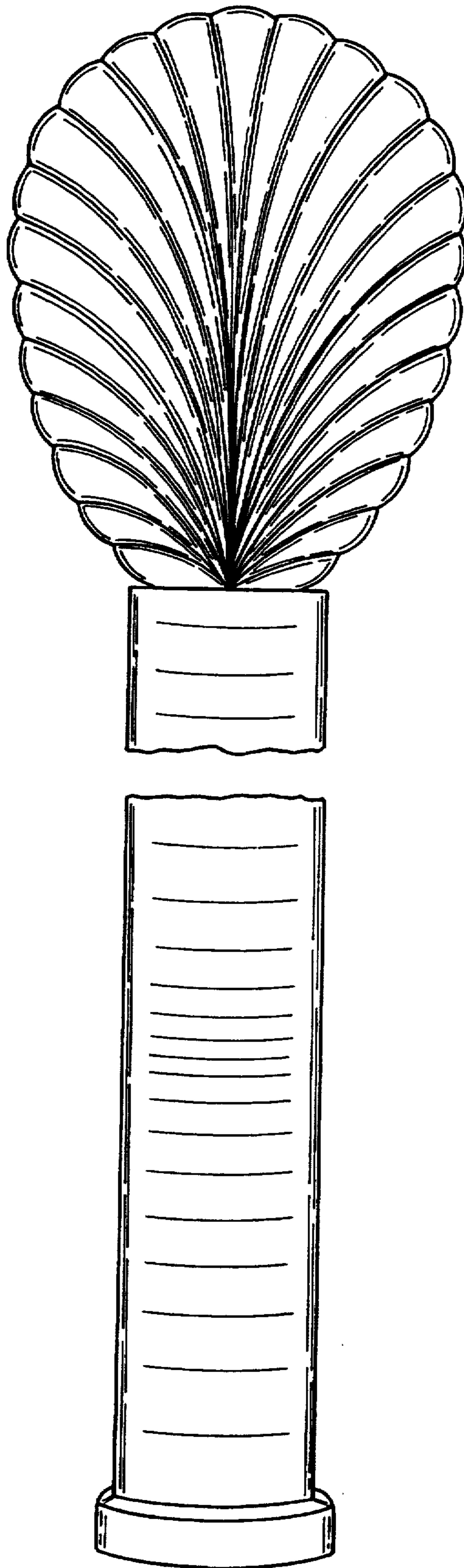

FIG. 4

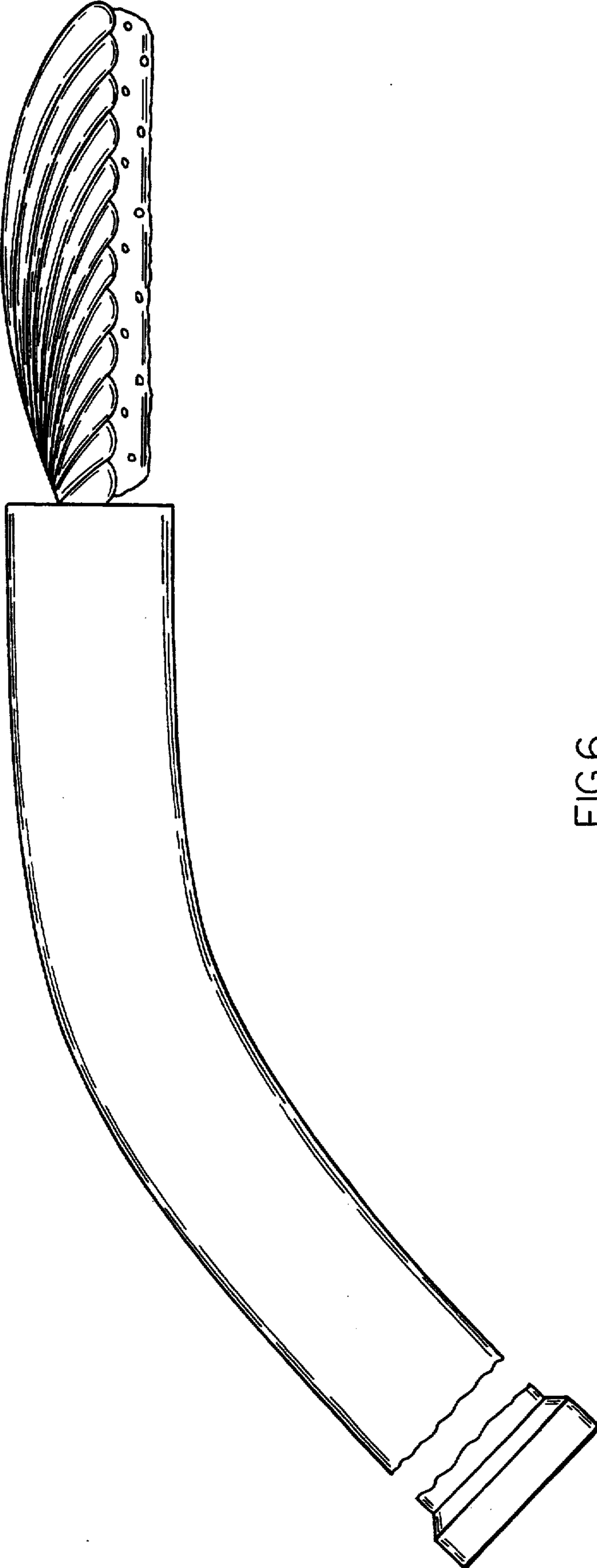

FIG.6